



Labour
Force
Survey

User Guide

VOLUME 9 – Eurostat 2010 - 2017

CONTENTS

SECTION 1: INTRODUCTION TO LFS USER GUIDE VOLUME 9 (EUROSTAT)	1
SECTION 2:	
An introduction to Eurostat - - - - -	2
Eurostat databases - - - - -	3
Eurostat Publications - - - - -	4
Organisation of Eurostat - - - - -	5
A brief history of Eurostat - - - - -	5
Eurostat Address - - - - -	6
SECTION 3: LABOUR FORCE SURVEYS IN THE EUROPEAN UNION	
The purpose of labour force surveys - - - - -	7
The history of labour force surveys - - - - -	9
The development of the EU Labour Force Survey - - - - -	9
The organisation of the EU Labour Force Survey - - - - -	11
Data Collection and diffusion of results - - - - -	11
SECTION 4: TECHNICAL FEATURES OF THE EU LABOUR FORCE SURVEY	
Field of the survey/reference period/units of measurement - - - - -	13
Reliability of the results/comparability of results between countries - - - - -	14
Comparability of results between successive surveys - - - - -	15
Basic concepts and definitions - - - - -	16
SECTION 5: REGULATIONS	
5a: COUNCIL REGULATION 577/98 OF THE EUROPEAN UNION	
Article 1 – Frequency of the survey - - - - -	19
Article 2 – Units and scope of the survey, observation methods - - - - -	20
Article 3 – Representativeness of the sample - - - - -	21
Article 4 – Survey characteristics - - - - -	21
Article 5 – Conduct of the survey - - - - -	24
Article 6 – Transmission of results - - - - -	24
Article 7 – Reports - - - - -	24
Article 8 – Procedure - - - - -	25
5b: COMMISSION REGULATION 2257/2003 OF THE EUROPEAN UNION - - - - -	26
5c: COMMISSION REGULATION 430/2005 OF THE EUROPEAN UNION - - - - -	28
5d: COMMISSION REGULATION 377/2008 OF THE EUROPEAN UNION - - - - -	30
SECTION 6: EU-LABOUR FORCE SURVEY - DATA CODIFICATION 2009 - - - - -	34
Supplementary variables 2012 - - - - -	50
Supplementary variables 2014 - - - - -	50
SECTION 7: EXPLANATORY NOTES TO THE LFS LIST OF VARIABLES - - - - -	51

SECTION 8: EUROSTAT LFS AD HOC MODULES								101
NB – full details of EU-LFS ad hoc modules can now be found in LFS User Guide Vol. 9a								
SECTION 9: EUROSTAT DERIVED VARIABLE FLOWCHARTS	-	-	-	-	-	-	-	103
ANNEX I: UK Regional codes used in the EU-LFS: NUTS10 and NUTS13	-	-	-	-	-	-	-	337
ANNEX II: Statistical Classification of Economic Activities: NACE Rev. 2 (2009)	-	-	-	-	-	-	-	345
ANNEX III								
a: International Standard Classification of Occupations: ISCO-88	-	-	-	-	-	-	-	354
b: International Standard Classification of Occupations: ISCO-08 (COM)	-	-	-	-	-	-	-	363
c: Mapping SOC2000 to ISCO-88	-	-	-	-	-	-	-	375
d: Mapping SOC2010 to ISCO-08	-	-	-	-	-	-	-	381
ANNEX IV								
a: ISO Country Classification from 2012	-	-	-	-	-	-	-	382
b: Mapping CRY07 to ISO Country Classification	-	-	-	-	-	-	-	387
ANNEX V								
a: Eurostat variable names and UK equivalents 2012 - 2013	-	-	-	-	-	-	-	392
b: Eurostat variable names and UK equivalents 2014	-	-	-	-	-	-	-	395
c: Eurostat variable names and UK equivalents 2015	-	-	-	-	-	-	-	398
d: Eurostat variable names and UK equivalents 2016	-	-	-	-	-	-	-	401
Index of EU-LFS variable flowcharts	-	-	-	-	-	-	-	404

SECTION 1: INTRODUCTION TO LFS USER GUIDE VOLUME 9 (EUROSTAT)

This volume of the LFS User Guide has been compiled in response to the increasing interest in the LFS data used by Eurostat, and in Eurostat itself. Most of the contents have been taken from Eurostat's internet web site and various publications such as *The European Union Labour Force Survey – Methods and Definitions*.

The structure of this volume is as follows.

Section 2 provides a summary of Eurostat's objective, coverage, and structure. Section 3 describes the purpose and development of an EU-wide Labour Force Survey – essentially, the pulling together of the LFS conducted in each Member State. Section 4 provides some technical detail of the EU LFS.

The latest EU LFS Regulation (No. 377/2008) implements Council Regulation No. 577/98 on the organisation of a labour force sample survey in the Community concerning the codification to be used for data transmission from 2009 onwards and the use of a sub-sample for the collection of data on structural variables. The text of these regulations is shown in Section 5.

Sections 6 and 7 compliment the fifth section. Essentially, whilst the Regulations outline the broad areas for which data are required, section 6 provide the associated data codification. This describes how the LFS database provided to Eurostat is structured in terms of database columns and the values which can be included in each column. Section 7 has the explanatory notes relating to each variable. These notes are intended to help Member States collect data which are sufficiently comparable for Eurostat's purposes. They are also useful to data analysts to see exactly what has been collected.

Each year Eurostat includes a number of variables that provide information on aspects of the labour market but which do not form part of the standard questionnaire. This set of variables, constitute an "*ad hoc* module". Section 8 explains this in more detail.

Finally, section 9 provides flowcharts which show how each of the variables supplied to Eurostat are derived from the questions actually asked in the UK LFS.

SECTION 2: EUROSTAT – AN INTRODUCTION

Eurostat - the "Statistical Office of the European Communities" was established in 1953. Its mission is *to provide the European Union with a high-quality statistical information service, by using uniform rules to collect all statistical data from the National Statistical Institutes of each of the Member States of the European Union.*

Once these data have been collected in the required form, they are consolidated and then harmonised to take into account each country's specific characteristics, so that they can be used either globally or comparatively.

This process of harmonising statistical data also extends to all the European Union's partners: members of the European Economic Area (EEA), including Switzerland, and, in a number of fields essential to an understanding of Europe's position in the world, the USA and Japan.

As with any service provider, Eurostat's prime aim is to answer requests for specific statistical information. As it is the Statistical Office of the European Communities, these requests most frequently come from the European Commission.

They are followed by 3 essential steps:

1. Validation of the statistical research itself

Together with the appropriate Directorates-General plus experts' reports and the recommendations of international organisations (e.g. UN, OECD), Eurostat prepares a statistical programme which is submitted to the European Commission's "Statistical Programme Committee". Eurostat then works with the different committees, expert groups and working groups concerned to achieve a broad consensus on the proposed new statistics.

2. Data Collection

Eurostat collects its data from the National Statistical Institutes of the countries concerned. All data are checked by Eurostat, compiled in the required form and, where applicable, harmonised with European Statistical System standards.

3. Legal base

When new statistics are adopted in the European Union, or when there is a need to harmonise statistics from Member States, the decision is taken by a Council legal act which may take one of the following 3 forms:

- regulation
- directive
- recommendation

In 2005, Eurostat had around 800 employees, including registered national experts on temporary assignment and permanent European civil servants. They are all committed to the same fundamental mission: to provide the European Union with a high-quality harmonised statistical information service, offering the best possible guarantees of completeness and reliability.

A special Committee of the Commission grants Eurostat a budget for the implementation of the statistical programme. In 2003, Eurostat had a budget of around 56 million Euros.

Eurostat Data

Statistical data that are collected, harmonised and referenced by Eurostat are disseminated as

electronic products and computerised media, printed publications or databases. They are regularly updated and are divided into 10 major statistical themes:

- Key indicators on EU policy
- General and regional statistics
- Economy and finance
- Population and social conditions
- Industry, trade and services
- Agriculture, forestry and fisheries
- External trade
- Transport
- Environment and energy
- Science and technology

Eurostat databases

Eurostat offers a thematic selection of databases that are constantly added to, updated and harmonised. They include:

- Ramon, which houses all the past and present metadata such as classifications, concepts and definitions
- New Cronos, which contains some 70 million items of statistical data on Member States of the European Union, and, in many cases, on their main non-European economic partners
- Comext, "external trade database": for data on imports and exports by EU countries in both value and volume terms
- REGIO, containing all Member States' socio-economic data, with regional breakdown
- Eurofarm, statistical data based on the Union surveys on the structure of agricultural holdings
- GISCO, database that combines statistical information and geo-referenced data, allowing each item of data to be related to its environment
- In line with its mission as a provider of statistical information, Eurostat offers users a DataShop service. The Eurostat Data Shops network is open to the public for any information on Eurostat databases, their respective data or access possibilities, as well as any specific statistical search.

Eurostat Publications

A lot of publications published by Eurostat contain Labour Force Survey data, *Employment in Europe* being the main one (170 pages of data analyses almost exclusively using LFS data).

Others include:-

- *Employment Outlook*
- *Europe in Figures*
- *Social Portrait of Europe*
- *Eurostat Yearbook*
- *Labour Force Survey in the EU, Candidate and EFTA countries*
- *Statistics in Focus*

Ordering these and other Eurostat publications can be done via Eurostat's information and distribution network:

- *The Eurostat Data Shops Network* – aimed at the broader public, these shops answer any specific request for information, publication or statistical research.
- *Private Hosts* – they disseminate entire Eurostat databases or part of them.
- *The National Statistics Institutes* – these provide references for national publications and main Eurostat data
- *Sales Offices* – there are about 45 of these that stock all EU publications.
- *Offices and Delegations* – these are the commission's official information centres. They provide the public with statistical information on current EU developments.
- *European Documentation Centres* – there are over 750 of these centres and libraries which officially house most Eurostat publications.
- *Euro-info-centres* – these were created by the European Commission for helping small and medium sized enterprises, there are over 200 of them.

Organisation of Eurostat

Eurostat is headed by a Director-General. Under him are seven Directors responsible for different sectors of Eurostat activities:

- Resources
- Statistical methods and tools; dissemination
- National and European accounts
- Economic and regional statistics
- Agriculture and environment statistics; statistical cooperation
- Social statistics and information society
- Business statistics

A Brief History of Eurostat

Since it was founded in 1953, Eurostat has pursued its primary role of developing and setting up a reliable, complete and harmonised source of European statistical information. The following are important milestones:

1953	Foundation of the Statistics Division of the High Authority of the Coal and Steel Community.
1958	Foundation of the Statistics Division of the European Communities.
1959	Adoption of the present title "Statistical Office of the European Communities". Staff: 58. First labour costs survey. First publication of "Agricultural statistics".
1960	First Community labour force survey.
1961	First agricultural supply balance sheet compiled on a Community basis.
1962	First overall energy balance sheets.
1965	Publication of the first national input-output tables (1959).
1966	First Community farm structure survey.
1968	First regular labour force survey in the Community.
1970	Publication of the European System of Integrated Economic Accounts (ESA). General industrial classification of economic activities within the European Communities (NACE).
1972	Council Regulation on the Nimex nomenclature.
1974	First domain installed in the Cronos databank.
1976	First use of purchasing power parities in connection with the ESA. First forecast of agricultural incomes using the Sectoral Income Index.
1978	The Member States compile and supply statistics according to the Nimex.
1981	Cronos accessible on-line on the Euronet network via commercial hosts. First publication of raw materials balance sheets. Publication of the "Handbook of Economic Accounts for Agriculture".
1982	On-line access to the Comext external trade databank on the Euronet network.
1987	First publication of the foreign trade volume indices.
1988	Introduction of the Harmonised System (HS) for the Collection and processing of external trade data according to the combined nomenclature (CN). Communication to the Commission on Community policy and statistical information.
1989	Adoption of the Directive on the compilation of GNP. Adoption by the Council of the 1989-1992 Statistical Programme as an instrument for implementing statistical information policy.
1990	As a result of German unification on 3 October 1990, the sphere of responsibility of the EC and hence of Eurostat increases.
1991	Eurostat's role extended as a result of the agreement on the establishment of the

- EEA (European Economic Area) in October 1991.
In December, adoption of the Treaty on European Union by the European Council in Maastricht ushers in a new phase for Eurostat.
All statistical data on EC external trade and trade between Member States (Comext) published on CD-ROM.
- 1992 Adoption of the 1993-1997 Statistical Programme, which includes the EFTA countries.
- 1993 Start of the single market in 1993 extends Eurostat's activities (e.g. Intrastat).
Publication of the new CD-ROM: general socio-economic information.
Eurostat starts issuing regular news releases on its statistics and achieves widespread publicity in the European news media.
- 1994 First European household panel held, analysing income, employment, poverty, social exclusion, households, health etc
- 1995 The entry of Austria, Sweden and Finland into the European Union further extends Eurostat's role.
- 1997 Statistics added for the first time to the Treaty of Amsterdam and the Statistical Law approved by the Council. Harmonised Indices of Consumer Prices published for the first time - designed for EMU convergence criteria.
- 1998 The 11 countries in at the start of EMU (EUR-11) announced and Eurostat issues the first indicators specific to the EMU area. Statistical programme 1998-2002 adopted.
- 1999 Start of EMU, 1st January 2001 Greece joins to euro-zone,
- 2002 Start of the euro, 1st January. Statistical programme 2003-2007 adopted.
- 2002 Announced at the Copenhagen Summit in December 2002 that Cyprus, the Czech Republic, Estonia, Hungary, Latvia, Lithuania, Malta, Poland, Slovakia and Slovenia would join the European Union on 1 May 2004, and other countries should follow in 2007.
- 2004 Start of free of charge dissemination of all statistical data except microdata for research purposes.
- 2005 Commission Recommendation on the independence, integrity and accountability of the national and Community statistical authorities (European Statistics Code of Practice)
- 2005 Start of a three year peer review exercise across the European Statistical System to check the compliance with the Code of Practice.
- 2007 The currently valid 5 years Statistical Programme was adopted.
- 2008-2012 2009 New European Regulation governing the statistical cooperation in the European Union was adopted.

Eurostat Address

Statistical Office of the European Communities
Batiment Joseph Bech
5 Rue Alphonse Weicker
L-2721 Luxembourg

Telephone (+352) 4301-34567 Fax (+352) 4301-32594
E-mail info.desk@EuroStat.cec.eu.int
Web site <http://europa.eu.int/EuroStat.html>

SECTION 3: LABOUR FORCE SURVEYS IN THE EUROPEAN UNION

The purpose of labour force surveys

A labour force survey is a survey directed to households designed to obtain information on the labour market and related issues by means of personal interviews. As it would clearly involve considerable expense to include all households (as in population censuses) labour force surveys are usually confined to a sample of households, the actual size of which depends primarily on the level of detail required in the survey estimates.

There are a number of advantages in using an approach of this kind in collecting labour market information. In the first place it affords the opportunity to obtain information on relevant labour market aspects across all sectors of the economy in a consistent manner. It also facilitates the interpretation of the information in a wider population setting, since the information collected need not necessarily be confined to persons in the labour force (i.e. those employed or unemployed), but can involve all other persons in the households covered. In current labour market circumstances this is an important additional dimension as analysis is increasingly concerned with those on the peripheries of the labour market.

In recent decades the borderline between the labour force and what is termed the *economically inactive* population has become increasingly blurred, due to the increasing incidence of part-time and temporary work and the ease with which large numbers of persons (particularly women and young persons in the final stages of their education) repeatedly enter or leave the labour force. Furthermore, the emergence of mass unemployment and long-term unemployment resulted in a great many individuals becoming “marginalised” in the sense that they tend to lose tangible contact with the core labour market. The wider coverage associated with labour force surveys also allow the possibility of assessing labour market effects in a household or family context. This is important if, for example, one wants to measure the extent to which persons other than those directly involved (e.g. spouses, other dependants, etc.) are affected by the circumstances of unemployment.

Another advantage of a labour force survey is that it affords the opportunity to define certain labour market characteristics not normally available from other statistical sources. Thus, for example, it is possible to identify the degree of employment engaged in by an individual in terms of the hours worked, or attempt to conceptualise unemployment in terms of aspects such as job search and availability for work. This is important because of the advantages it confers in being able to define certain labour market entities in a more meaningful way. Additionally, because the definitions used to measure these entities are the same for each country, comparability between Member States is guaranteed for certain estimates. This aspect is clearly of considerable importance in the context of the European Union.

There are however some limitations which apply to labour force surveys. Cost considerations place a constraint on the overall household sample size and the resultant sampling variability limits the level of detail that can reasonably be shown. Thus, for example, while the labour force survey can be used to compile estimates of employment across economic sectors, it cannot be expected to yield reliable figures at a detailed level of regional desegregation, nor for individual small industrial or commercial sub-sectors. The sampling base on which such estimates would depend would be too small, and the degree of variability correspondingly high. For the same reason, there is also a limit to what can be achieved with labour force

surveys in monitoring trends over time (in employment and unemployment, for example), especially if the movements involved are relatively small.

It is appropriate at this point to refer briefly to other sources of statistical information so that the position of the labour force survey in an overall statistical perspective can be more clearly understood. The other principal sources of labour market information are:-

- (a) surveys of enterprises and
- (b) administrative records.

The former source clearly has the potential for providing detailed estimates of employment for individual sectors (and in fact this is done in many countries). However, such a source is clearly restricted to a consideration of those with jobs and cannot provide any information on the unemployed, nor other persons outside the labour force but who may have an attachment to it. Such surveys can, however, be used to obtain information, not only in relation to employment, but also to output, earnings and hours worked. The simultaneous collection of consistent data on employment and output makes it possible to compile indicators of productivity. Indeed, the derivation of output-type information is usually the main purpose of enterprise-based surveys. Many countries, for example, carry out detailed quarterly or monthly surveys of the industrial sector which provide consistent information on output, earnings, employment and other related aspects.

Administrative records, such as social insurance records or population registers as widely used in Denmark, Sweden and Finland, can also be used to provide indicators of the levels of employment and unemployment. A prerequisite, however, is that the administrative arrangements should specifically cater for the extraction of the relevant statistics. While this source involves relatively less expense than information derived from either enterprise or household surveys, it suffers from a significant disadvantage in that the underlying systems are based on social welfare or other administrative provisions which may not necessarily accord with the accepted conventions for defining employment and unemployment. Furthermore, if these arrangements are changed (and experience indicates that they frequently are), discontinuity invariably arises in the data. A disadvantage of even greater relevance in an international or EU context is the fact that the social insurance systems in question vary greatly from country to country, both in terms of their design and in the manner of their implementation. This renders the derived information virtually useless in the context of making comparisons between countries, especially in absolute terms. Such sources can, however, provide a reasonable basis for monitoring short-term (i.e. monthly, quarterly, etc.) trends, the most notable in this regard being the various national series on the registered unemployed.

To summarise, therefore, the principal advantages associated with labour force surveys relate to:

- (1) the opportunity of obtaining comprehensive information (at less cost than a census) across the entire economy, which can be assessed in a global setting embracing society as a whole;
- (2) the inherent flexibility of such surveys, which makes it possible to define or conceptualise not only employment and unemployment, but also the circumstances surrounding other groups outside or on the margins of the labour force.

This latter feature (i.e. the facility to conceptualise or define) has assumed greater importance in recent years because of the manner in which labour markets and society have generally evolved, and in view of the growing need to view labour market phenomena in an international context. It must be recognised, however, that the sampling aspect associated with labour force surveys places a limitation on the level of detail possible when analysing the results.

The history of labour force surveys

The notion of obtaining information on the work force by means of household-based surveys is not in any sense new. Questions on the concept of possessing a *gainful occupation* were introduced in censuses of population in some countries during the latter half of the last century. However, at that stage no questions were asked in regard to what is termed a person's economic status, i.e. whether at work, unemployed or economically inactive. Indeed, at that stage such a notion was hardly even conceived. However, the advancing trend of industrialisation and the resultant restructuring of society created a need for new, approaches, and for more sophistication in measuring labour market phenomena. The situation became particularly urgent with the advent of mass unemployment in the 1930's following the Great Depression. Whatever the uncertainties that may have previously existed regarding the need to conceptualise or measure unemployment were dispelled by the sheer fact of millions in a state of enforced idleness. There was now a clear need to have regular information on the level and trend of employment and unemployment. The first labour force survey was introduced in the United States in 1940 (on a monthly basis) with a new conceptual framework designed to provide information on relevant labour market characteristics.

The movement towards the use of labour force surveys was somewhat slower in Europe. While the intervention of the war years contributed to this, it was also due to the existence of alternative sources of information which provided at least a partial insight into aspects of the labour force. Virtually all Western European countries maintained comprehensive unemployment registers for the purpose of dispensing unemployment compensation which, despite their disadvantages, provided a rudimentary basis for monitoring unemployment trends. However, in time, as the need to take a more global view of the labour market became apparent, different European countries began to initiate labour force surveys. The first European country to carry out a labour force survey was France in 1950. Further such surveys were conducted in France throughout the subsequent decade and these evolved into a regular consistent series in the early 1960s. After an extended period of preparation, the Federal Republic of Germany initiated an annual series of labour force surveys in 1957 (the *Mikrozensus*). Sweden conducted its first labour force survey in 1959 and, after further experimentation, initiated a quarterly series in 1963.

The development of the EU Labour Force Survey

More than forty years have passed since the first attempt was made in 1960 to collect comparable data on employment and unemployment from the six original Member States of the then European Community by means of a labour force survey. Since that date, the number of Member States has risen to twenty-five and the character of the European labour market has been transformed by the changes which have taken place, for example in employment rates, in the allocation of working-time, and in the distribution of employment across the various sectors of the economy.

Throughout this period, the institutions of the European Union have included the issues of employment and unemployment among their highest priorities. In consequence, the demand

for accurate and comparable information on the labour market has progressively become more urgent.

In this context, the role of the EU Labour Force Survey (LFS) has gained steadily in importance and is now universally recognised as an indispensable tool for observing labour market developments and for taking the appropriate policy measures. The LFS is the only source of information in these areas to provide data, which is truly comparable in the sense of being independent of the national administrative and legislative framework. Among the statistical instruments available in the European Union, the LFS is unique for the sample-size it covers, for the length of the time-series which it offers, and for the unrivalled picture it can provide of economic and social developments from the very earliest days of the European Community right up to the present day.

No.	From	To	Main developments
1.	1960		The first LFS was organised in the six original member states in 1960 by Eurostat. The countries are Belgium, Germany, France, Italy, Luxembourg and Netherlands.
2.	1968	1971	Annual surveys introduced. Not all six member states were covered in each year.
3.	1973	1981	Biennial surveys initiated due to EU enlargement. The UK was the only one of the three new members to join in 1973 but Ireland and Denmark also took part in 1975, 1977, 1979 and 1981.
4.	1983	1991	Annual surveys on the basis of a revised set of concepts designed to guarantee an improved degree of comparability between the member states. The concepts and definitions used were those adopted by the 13th International Conference of Labour Statisticians of 1982. The methodological basis is described in the publication <i>LFS - Methods and Definitions 1988</i> .
5.	1992	1997	In 1992, a number of changes were introduced with the aim of improving the quality of the data and their reliability at national and regional level; Council Regulation (EEC) 3711/1991 specified the contents and reliability criteria for the survey, to be conducted annually from 1992. The methodological basis and the content of the series of surveys between 1992 and 1997 are described in the publication <i>LFS - Methods and Definitions - 1992 series</i> .
6.	1995	2000	LFS covers all 15 member states.
7.	1998	2000	In 1998 the Council regulation n° 577/1998 was adopted and replaced the previous one to take into account new statistical requirements. The methodological basis and the contents of this new series of surveys are described in the publication <i>LFS - Methods and Definitions -1998</i> .
8.	2001	2005	In 2000 the regulation n° 1575/2000 was adopted concerning the codification to be used for data transmission from the year 2001 onwards. The 2001 codification can be found at http://forum.europa.eu.int/irc/dsis/employment/info/data/eu_lfs/lfs_regulations.htm
9.	2000		LFS covers all 25 member states.
10.	2002		Regulation 1991/2002 of the European Parliament and of the Council of 8 October 2002 amending Council Regulation (EC) No 577/98 on the organisation of a labour force sample survey in the Community introduced a deadline (end of 2002) for the period of transition given to the Member States to introduce a continuous quarterly survey (derogation periods for Cyprus until the end of 2004 and Germany until the end of 2005).
11	2005		Regulation No. 430/2005 amended 577/98 on the organisation of a labour force sample survey in the Community concerning the codification to be used for data transmission from 2006 onwards and the use of a sub sample for the collection of data on structural variables.
12	2008		Regulation No. 377/2008 amended 577/98 on the organisation of a labour force sample survey in the Community concerning the codification to be used for data transmission from 2009 onwards and the use of a sub sample for the collection of data on structural variables.

The Organisation of the EU Labour Force Survey

The earliest Community Labour Force Surveys were not covered by legislation, but, from 1973 onwards, a Regulation was passed by the Council of Ministers governing the operation of the survey. Each Regulation applied only to a single year's survey, until the surveys of 1990 and 1991 were included in one Regulation (Council Regulation (EEC) No. 3044/89). In 1998 a new Regulation was adopted (Council Regulation (EEC) No. 577/98).

EU regulations stipulate the agreements reached by the Member States and Eurostat on the implementation of the survey. The technical aspects of the survey are discussed by Eurostat and representatives of the respective national statistical offices and employment ministries, meeting regularly (between one and three times a year) at the Labour Market Statistics Working Group held in Luxembourg. This Working Group determines the content of the survey, the EU list of questions and the common coding of individual replies, as well as the principal definitions to be applied for the analyses of the results.

The national statistical institutes are responsible for selecting the sample, preparing the questionnaires, conducting the direct interviews among households, and forwarding the results to Eurostat in accordance with the common coding scheme. Eurostat devises the programme for analysing the results and is responsible for processing and disseminating the information sent by the national statistical institutes.

The questionnaires are drawn up by each Member State in the national language or languages, taking into account the stipulations made in the Regulation. For every survey characteristic listed in the Regulation, a question or series of questions exists in each questionnaire to permit this information to be supplied to Eurostat. Otherwise the information is imputed from other sources such as population registers. The questionnaires may also contain other questions which do not relate to the list of characteristics in the Regulation, but rather reflect an interest in the topic concerned at national level. Based on the sample design the figures obtained from the sample survey are expanded to population levels, usually on the basis of weighting factors derived from the most recent census of population, suitably adjusted to take account of recent changes which may have occurred since that census.

Data Collection and diffusion of results

As soon as each Member State has completed its data collection and verification, the part pertaining to the EU Labour Force Survey is, if necessary, transcoded to Eurostat requirements and transmitted by magnetic support. Eurostat then checks the data for errors according to its own programme of controls. When the data are considered to be error-free they are converted into a SAS database, which can be easily accessed to produce reports. For reasons of confidentiality this database may only be accessed by accredited Eurostat personnel.

Most Member States produce regular publications setting out the results of their national surveys. The yearly report at EU level, which, as mentioned, is the responsibility of Eurostat, contains five main sections covering population and activity, employment, working time, unemployment and search for work, and households. Some specific organisational and methodological notes are included in this publication, but, in the interests of rapid diffusion of the results, an attempt is made to analyse the data. From 1994 onwards a selection of graphs has been included in order to improve the presentation of the results.

Detailed studies of labour market developments in the European Union may be found in the annual Commission Report *Employment in Europe* and, in the wider context of the highly-developed countries, in the OECD's *Employment Outlook*. Data are supplied from the EU LFS database for these publications as well as for a plethora of other studies and reports at national and international level.

Within Eurostat, the richness of the EU Labour Force Survey, including its household dimension, causes it to be frequently used for general publications such as *Europe in Figures* and the *Social Portrait of Europe*. The EU LFS database is also occasionally used to provide data for the publication of Rapid Reports by other services of Eurostat. Among more specialised applications is the use of the database to produce comparable annual estimates of unemployment which, when combined with monthly national administrative data, provide comparable unemployment rates, as published in Eurostat's monthly *bulletin Unemployment in the European Union*. Additionally, the preparation of policy actions in the field of EU social and regional policy through the operation of the Structural Funds relies upon the availability of a solid base of comparable data from the EU Labour Force Survey.

The survey results are completely integrated into the Eurostat statistical system, so that they may be consulted for example through the New Cronos and Regio databases. Users with specific data requirements which are not satisfied by the existing publications and databases may also ask for specified tables to be produced on a chargeable basis. Several hundred such requests are received each year from different public and private bodies, research institutes, universities, etc. They may be addressed to the central Eurostat Information Office (+352-4301-34567; fax 4301-436404), and Eurostat is currently extending its data dissemination facilities, setting up Data Shops in every Member State.

The growing volume of this demand for information is an eloquent testimony to the central role of the Labour Force Survey in the European Statistical System. In the field of social statistics there is no other instrument which provides information on social and economic developments within the European Union over such a long time-span, with such a large sample-size or with such a level of comparability.

SECTION 4: TECHNICAL FEATURES OF THE EU LABOUR FORCE SURVEY

Field of the Survey

The survey is intended to cover the whole of the resident population, i.e. all persons whose usual place of residence is in the territory of the Member States of the European Union. For technical and methodological reasons, however, it is not possible in all countries to include the population living in collective households, i.e. persons living in homes, boarding schools, hospitals, religious institutions, workers' hostels, etc.

Consequently, for the purpose of harmonising the field of survey, results are compiled for the population of private households only. This comprises all persons living in the households surveyed during the reference week, and those persons absent from the household for short periods due to studies, holidays, illness, business trips, etc.

It does not cover persons who, although having links with the household under survey:

- (a) usually live in another household;
- (b) live in collective households (in particular, persons doing compulsory military service are excluded from the population of private households and regarded as members of collective households, even if during the reference week they are present in the private household to which they belong);
- (c) have emigrated.

Reference period

The labour force characteristics of each person interviewed refer to their situation in a particular week. While this reference week falls in spring in all countries, the national statistical institutes determine the exact week(s) according to the particular situation in each country. The reference weeks used in the different Member States are shown in the yearly reports containing the survey results. As a general rule the reference week should be a normal week, i.e. it should exclude bank holidays. For countries using a fixed reference week, this requirement is easy to fulfil. In some countries, however, the survey extends over a period of time and, as the reference week is the one preceding the week of the interview, the reference week varies. In this case, the reference week may sometimes include public holidays, such as Easter.

Units of measurement

The main units of measurement for which results are obtained from the survey are individuals and households. The definition of a household varies somewhat from country to country but these differences are unlikely in the majority of cases to have a significant effect on the comparability of the results.

Reliability of the results

As with any sample survey, the results of the Labour Force Survey are subject to sampling errors. In addition, the results of any sample survey are affected by non-sampling errors, i.e. the whole variety of errors other than those due to sampling. These can be due to many factors such as inability or unwillingness of respondents to provide correct answers or even any answer at all (non-response), mistakes by interviewers when filling in survey documents, miscoding, etc. Methods exist to assess the influence of these non-sampling errors on the accuracy of the survey results, but being often costly, are not generally applied.

Experience shows that at national level the survey information provides sufficiently accurate estimates for the levels and structures of the various aggregates into which the labour force is divided, provided that analyses of this type are confined to levels of a certain size. Survey results at regional level may, however, be affected by considerable sampling errors, even for relatively large groups of the population. Reliability of the results is assured by the size of the samples and the sampling methods used, in addition to careful and thorough planning of the various survey operations and rigorous administration of all phases of the survey.

Comparability of results between countries

Perfect comparability among the countries is difficult to achieve, even were it to be by means of a single direct survey, i.e. a survey carried out at the same time, using the same questionnaire and a single method of recording.

Nevertheless, the degree of comparability of the EU Labour Force Survey results is considerably higher than that of any other existing set of statistics on employment or unemployment available for Member States. This is due to:

- (i) the recording of the same set of characteristics in each country;
- (ii) a close correspondence between the EU list of questions and the national questionnaires;
- (iii) the use of the same definitions for all countries;
- (iv) the use of common classifications (e.g. NACE for economic activity);
- (v) the synchronisation of the survey in spring;
- (vi) the data being centrally processed by Eurostat.

The EU Labour Force Survey, although subject to the constraints of the EU's statistical requirements, is a joint effort by Member States to co-ordinate their national employment surveys, which must serve their own national requirements. Therefore, in spite of the close co-ordination between the national statistical institutes and Eurostat, there inevitably remain some differences in the survey from country to country. This is especially the case for population coverage, labour status coverage, main economic activity definition, participation in education, highest educational level attainment and transition to a quarterly continuous survey. The new LFS Explanatory Notes developed for implementation from quarter 1, 2008, have been designed to ensure greater harmonisation and comparability of results between countries.

Comparability of results between successive surveys

Since 1983 improved comparability between results of successive surveys has been achieved, mainly due to the greater stability of content and the higher frequency of surveys. However, the following factors may somewhat detract from perfect comparability:

- (i) the population figures used for the population adjustment are revised at intervals on the basis of new population censuses;
- (ii) the reference period may not remain the same for a given country;
- (iii) in order to improve the quality of results, some countries may change the content or order of their questionnaire;
- (iv) countries may modify their sample designs;
- (v) the manner in which certain questions are answered may be influenced by the political or social circumstances at the time of interview.

Eurostat has provided the main factors affecting the comparability of the data for successive surveys in their publications containing the results.

Basic concepts and definitions

The main statistical objectives of the Labour Force Survey is to divide the population of working age (15 years and above) into three mutually exclusive and exhaustive groups - persons in employment, unemployed persons and inactive persons - and to provide descriptive and explanatory data on each of these categories. Respondents are assigned to one of these groups on the basis of the most objective information possible obtained through the survey questionnaire, which principally relates to their actual activity within a particular reference week.

The definitions of employment and unemployment used in the Labour Force Survey closely follow those adopted by the 13th International Conference of Labour Statisticians.

The relevant parts of these 'ILO definitions' are:

Employment

9.(1) The employed comprise all persons above a specified age who during a specified brief period, either one week or one day, were in the following categories:

- (a) "paid employment":
 - (al) "at work": persons who during the reference period performed some work for wage or salary, in cash or in kind;
 - (a2) "with a job but not at work": persons who, having already worked in their present job, were temporarily not at work during the reference period and had a formal attachment to their job. This formal job attachment should be determined in the light of national circumstances, according to one or more of the following criteria:
 - (i) the continued receipt of wage or salary;
 - (ii) an assurance of return to work following the end of the contingency, or an agreement as to the date of return;
 - (iii) the elapsed duration of absence from the job which, wherever relevant, may be that duration for which workers can receive compensation benefits
- (b1) "at work": persons who during the reference period performed some work for profit or family gain, in cash or in kind;
- (b2) "with an enterprise but not at work": persons with an enterprise, which may be a business enterprise, a farm or a service undertaking, who were temporarily not at work during the reference period for any specific reason.

9.(2) For operational purposes, the notion of "some work" may be interpreted as work for at least one hour.

Unemployment

10.(1) The "unemployed" comprise all persons above a specified age who, during the reference period, were:

- (a) "without work", i.e. were not in paid employment or self-employment, as defined in paragraph 9;
- (b) "currently available for work", i.e. were available for paid employment or self-employment during the reference period-;
- (c) "seeking work", i.e. had taken specific steps in a specified recent period to seek paid employment or self-employment.

In applying these definitions to the EU Labour Force survey, the following reference periods are implemented:

- (i) In paragraph 10(b) "currently available" should mean available to start work within two weeks of the reference period.
- (ii) In paragraph 10(c) the "specified recent period" is the four weeks preceding the survey interview. During this period at least one active method to find work should be undertaken in order to satisfy the criterion of "seeking work".

Unemployed persons can be classified by reason for unemployment into four major groups-.

- (1) job-losers are persons whose employment ended involuntarily and immediately began looking for work;
- (2) job-leavers are persons who quit or otherwise terminated their employment voluntarily and immediately began looking for work-;
- (3) re-entrants are persons who previously worked, but were inactive or on compulsory military service before beginning to look for work;
- (4) first job-seekers are persons who have never worked in a regular job.

Labour force

The labour force comprises persons in employment and unemployed persons.

Inactive persons

All persons who are not classified as employed or unemployed are defined as inactive. Apart from showing pupils and students separately, no further breakdown is provided for this group. Conscripts on compulsory military or community service are excluded from the compilation of the survey results.

The above groups are used to derive the following measures:

- (a) *Activity rates*
Activity rates represent the labour force as a percentage of the population of working age (15 years or more).
- (b) *Employment/ population ratios*

Employment / population ratios represent persons in employment as a percentage of the population of working age (15 years or more).

(c) *Unemployment rates*

Unemployment rates represent unemployed persons as a percentage of the labour force.

(d) *Duration of unemployment*

defined as the shorter of the following two periods (a)the duration of search for work, or (b)the length of time since last employment.

The above rates are usually calculated for sex-age groups and are sometimes further cross-classified by other demographic variables such as marital status or nationality.

SECTION 5a:

COUNCIL REGULATION 577/98 OF THE EUROPEAN UNION

Whereas, in order to carry out the tasks assigned to it, the Commission needs comparable statistical information on the level and pattern of and trends in employment and unemployment in the Member States;

Whereas the best method of obtaining such information at Community level is to conduct harmonised labour force surveys;

Whereas Council Regulation (EEC) No 3711/91 of 16 December 1991 on the organisation of an annual labour force sample survey in the Community laid down that, starting in 1992, a survey was to be conducted in the spring of each year;

Whereas, although a continuous survey is preferable to an annual spring survey for ensuring the availability and harmonisation of data and measuring the volume of work, it is difficult to implement a continuous survey on the same dates in all Member States.

Whereas the use of existing administrative sources should be encouraged insofar as they can usefully supplement the information obtained through interviews or serve as a sampling basis;

Whereas the date in the survey, as fixed by this Regulation, may be extended to include a further set of variables forming part of a programme of ad hoc modules which covers several years, and which will be drawn up under an appropriate procedure as part of the implementation arrangements;

Whereas the principles of relevance and cost-effectiveness, as these are defined in Council Regulation (EC) No 322/97 of 17 February 1997 on Community Statistics which constitutes the legislative framework for the production of Community statistics, will also apply to this Regulation;

Whereas statistical confidentiality is governed by the rules set out in Regulation (EC) No 322/97 and in Council Regulation (Euratom, EEC) No 1588/90 of 11 June 1990 on the transmission of data subject to statistical confidentiality to the Statistical Office of the European Communities;

Whereas the Statistical Programme Committee established by Decision 89/382/EEC, Euratom has been consulted by the Commission in accordance with Article 3 of the aforesaid Decision,
has adopted this regulation:

Article I **Frequency of the survey**

A labour force sample survey, hereinafter referred to as 'the survey', shall be conducted by the Member States each year.

The survey is a continuous survey providing quarterly and annual results; however, those Member States which are not in a position to implement a continuous survey may carry out an annual survey only, to take place in the spring.

The information collected during the survey relates generally to the situation during the course of the week (taken to run from Monday to Sunday) preceding the interview, known as the reference week.

In the case of a continuous survey:

the reference weeks are spread uniformly throughout the whole year;

- the interview normally takes place during the week immediately following the reference week. The reference week and the date of the interview may not be more than five weeks apart, except in the third quarter;
- the reference quarters and years are respectively groups of 13 or 52 consecutive weeks. A list of the weeks making up a given quarter or year is drawn up according to the procedure laid down in Article 8.

Article 2

Units and scope of the survey, observation methods

1. The survey shall be carried out in each Member State in a sample of households or of persons residing in the economic territory of that State at the time of the survey.
2. The principal scope of the survey consists of persons residing in private households on the economic territory of each Member State. If possible, this main population of persons living in private households is supplemented by persons living in Collective households.

Wherever possible, Collective households are covered by means of samples specially drawn to permit direct observation of the persons concerned. If this is not possible, then persons in these groups who continue to have an association with a private household are included in connection with that household.

3. The variables used to determine labour status and underemployment must be obtained by interviewing the person concerned, or, if this is not possible, another member of the household. Other information may be obtained from alternative sources, including administrative records, provided that the data obtained are of equivalent quality.
4. Regardless of whether the sampling unit is an individual or a household, information is usually collected for all individuals of the household. However, If the sampling unit is an individual, the information concerning the other members of the household
 - may exclude the characteristics listed under Article 4(1)(g), (h), (i) and (j),
 - and may be Collected from a sub-sample defined in such a way that:
 - the reference weeks are uniformly distributed throughout the whole year;
 - the number of observations (individuals sampled plus the members of their household) satisfies, for the annual estimates of levels, the reliability criteria defined in Article 3.

Article 3
Representativeness of the sample

1. For a group of unemployed people representing 5% of the working age population the relative standard error for the estimation of annual averages (or for the spring estimates in the case of an annual survey in the spring) at NUTS II level shall not exceed 8% of the sub-population in question. Regions with less than 300,000 inhabitants shall be exempt from this requirement.
2. In the case of a continuous survey, for sub-populations which constitute 5% of the working age population the relative standard error at national level for the estimate of changes between two successive quarters, shall not exceed 2 % of the sub-population in question.

For Member States with a population of between one million and twenty million inhabitants, this requirement is relaxed so that the relative standard error for the estimate of quarterly changes shall not exceed 3% of the sub-population in question.

Member States whose population is below one million inhabitants are exempt from these precision requirements concerning changes.

3. Where the survey is carried out only in the spring, at least a quarter of the survey units are taken from the preceding survey and at least a quarter form part of the following survey.

These two groups shall be identified by a code.

4. Where non-response to certain questions results in missing data, a method of statistical imputation shall be applied where appropriate.
5. The weighting factors we calculated taking into account in particular the probability of selection and external data relating to the distribution of the population being surveyed by sex, age (five-year age groups), and region (NUTS II level), where such external data are held to be sufficiently reliable by the Member States concerned.
6. Member States shall provide the Commission (Eurostat) with whatever information is required concerning the organisation and methodology of the survey, and in particular, they shall indicate the criteria adopted for the design and size of the sample.

Article 4
Survey characteristics

1. Data shall be provided on;
 - (a) demographic background:
 - sequence number in the household
 - sex
 - year of birth
 - date of birth in relation to the end of the reference period
 - marital status
 - relationship to reference person
 - sequence number of spouse

- sequence number of father
 - sequence number of mother
 - nationality
 - number of years of residence in the Member State
 - country of birth (optional)
 - nature of participation in the survey (direct participation or proxy through another member of the household);
- (b) labour status;
- labour status during the reference week
 - reason for not having worked though having a job
 - search for employment for person without employment
 - type of employment sought (self-employed or employee)
 - methods used to find a job
 - availability to start work;
- (c) employment characteristics of the main job:
- professional status
 - economic activity of local unit
 - occupation
 - number of persons working at the local unit
 - country of place of work
 - region of place of work
 - year and month when the person started working in current employment
 - permanency of the job (and reasons)
 - duration of temporary job or work contract of limited duration
 - full-time/part-time distinction (and reasons)
 - working at home;
- (d) hours worked:
- number of hours per week usually worked
 - number of hours actually worked
 - main reason for hours actually worked being different from person's usual hours;
- (e) second job:
- existence of more than one job
 - professional status
 - economic activity of the local unit
 - number of hours actually worked
- (f) visible underemployment:
- wish to work usually more than the current number of hours (optional in the case of an annual survey)
 - looking for another job and reasons for doing so
 - type of employment sought (as employee or otherwise)
 - methods used to find another job
 - reasons why the person is not seeking another job (optional in the case of an annual survey)

- availability to start work
- number of hours of work wished for (optional in the case of an annual survey);
- (g) search for employment:
 - type of employment sought (full-time or part-time)
 - duration of search for employment
 - situation of person immediately before starting to seek employment
 - registration at public employment office and whether receiving benefits
 - willingness to work for person not seeking employment
 - reasons why person has not sought work;
- (h) education and training
 - participation in education or training during previous four weeks
 - purpose
 - level
 - type
 - total length
 - total number of hours
 - highest successfully completed level of education or training
 - year when this highest level was successfully completed
 - non-tertiary vocational qualification obtained;
- (i) previous work experience of person not in employment:
 - existence of previous employment experience
 - year and month in which the person last worked
 - main reason for leaving last job or business
 - professional status in last job
 - economic activity of local unit in which person last worked
 - occupation of last job;
- (j) situation one year before the survey (optional for quarters 1, 3, 4):
 - main labour status
 - professional status
 - economic activity of local unit in which person was working
 - country of residence;
 - region of residence;
- (k) main labour status (optional);
- (l) income (optional);
- (m) technical items relating to the interview
 - year of survey
 - reference week
 - interview week
 - member State
 - region of household
 - degree of urbanisation

- serial number of household
- type of household
- type of institution
- weighting factor
- sub-sample in relation to the preceding survey (annual survey)
- sub-sample in relation to the following survey (annual survey)
- sequence number of the survey wave.

2. A further set of variables, hereinafter referred to as an “ad hoc module”, may be added to supplement the information described above in paragraph 1.

A programme of ad hoc modules covering several years shall be drawn up each year according to the procedure laid down in Article 8:

- this programme shall specify for each ad hoc module, the subject, the reference period, the sample size (equal to or less than the sample size determined according to Article 3) and the deadline for the transmission of the results (which may be different from the deadline according to Article 6);
 - the Member States and regions covered and the detailed list of information to be collected in an ad hoc module shall be drawn up at least twelve months before the beginning of the reference period for that module;
 - the volume of an ad hoc module shall not exceed the volume of the module described under paragraph 1
3. The definitions, the edits to be used, the codification of the variables, the adjustment of the list of survey variables made necessary by the evolution of techniques and concepts, and a list of principles for the formulation of the questions concerning the labour status, are drawn up according to the procedure laid down in Article 8.

Article 5 **Conduct of the survey**

The Member States may make it compulsory to reply to the survey.

Article 6 **Transmission of the results**

Within twelve weeks of the end of the reference period in the case of a continuous survey (and within nine months of the end of the reference period in the case of a survey in the spring), the Member States shall forward to Eurostat the results of the survey, without direct identifiers.

Article 7 **Reports**

A report on the implementation of this regulation shall be submitted to the commission to the Parliament and the Council every three years, beginning in the year 2000. This report shall evaluate in particular the quality of the statistical methods envisaged by the member states to improve the results or to lighten the survey procedures.

Article 8 Procedure

The Commission shall be assisted by the Statistical Programme Committee, hereinafter referred to as "the Committee".

The representative of the Commission shall submit to the Committee a draft of the measures to be taken. The Committee shall deliver its opinion on the draft within a time limit which the chairman may lay down according to the urgency of the matter. The opinion shall be delivered by the majority laid down in Article 148(2) of the Treaty in the case of decisions which the Council is required to adopt on a proposal from the Commission. The votes of the representatives of the Member States within the Committee shall be weighted in the manner set out in that Article. The chairman shall not vote.

The Commission shall adopt the measures envisaged if they are in accordance with the opinion of the Committee.

If the measures envisaged are not in accordance with the opinion of the Committee, or if no opinion is delivered, the commission shall, submit to the council a proposal relating to the measures to be taken. The council shall act by a qualified majority.

If, on the expiry of a period of three months from the date of referral to the Council, the Council has not acted, the proposed measures shall be adopted by the Commission.

Note that Commission Regulation (EC) No 1575/2000 of 19 July 2000 implements Council Regulation (EC) No 577/98 on the organisation of a labour force sample survey in the Community concerning the codification to be used for data transmission from 2001 to 2005 (OJ No L 181/16).

The 2001 to 2005 codification can be found at
http://forum.europa.eu.int/irc/dsis/employment/info/data/eu_lfs/lfs_regulations.htm

Note that Commission Regulation (EC) No 430/2005 of 15 March 2005 implements Council Regulation (EC) No 577/98 on the organisation of a labour force sample survey in the Community concerning the codification to be used for data transmission from 2006 onwards.

Note that Commission Regulation (EC) No 377/2008 of 25 April 2008 implements Council Regulation (EC) No 577/98 on the organisation of a labour force sample survey in the Community concerning the codification to be used for data transmission from 2008 onwards.

SECTION 5b: COMMISSION REGULATION 2257/2003 OF THE EUROPEAN UNION

This is an amendment of Council Regulation (EC) No 577/98.

Whereas:

(1) The labour force sample survey to be carried out under Council Regulation (EC) No 577/98 should adequately cover new and recently emerging features of the labour market.

(2) According to the European social policy agenda adopted by the Nice European Council in December 2000, Council Decision 2002/177/EC of 18 February 2002 on guidelines for Member States' employment policies for the year 2002 and Council Recommendation 2002/549/EC of 21 June 2002 on the broad guidelines of the economic policies of the Member States and the Community, the way in which work is organised must be adapted to the needs of both businesses and individuals.

(3) The survey characteristics laid down in Regulation (EC) No 577/98 were determined according to statistical needs and the labour market situation prevailing at the time.

(4) Data collection should not impose on respondents a burden out of proportion with the results which users of the survey can reasonably expect.

(5) The Statistical Programme Committee, established by Council Decision 89/382/EEC, Euratom of 19 June 1989 has been consulted by the Commission.

(6) Regulation (EC) No 577/98 should therefore be amended accordingly,

HAVE ADOPTED THIS REGULATION:

Article 1

Article 4 of Regulation (EC) No 577/98 is hereby amended as follows:

1. Points (b), (c), (d) and (g) of paragraph 1 are replaced by the following:

‘(b) labour status:

- labour status during the reference week,
- continuing receipt of wages and salary,
- reason for not having worked though having a job,
- search for employment for person without employment,
- type of employment sought (self-employed or employee),
- methods used to find a job,
- availability to start work;

(c) employment characteristics of the main job:

- professional status,
- economic activity of the local unit,
- occupation,
- supervisory responsibilities,
- number of persons working at the local unit,
- country of place of work,
- region of place of work,
- year and month when the person started working in current employment,
- involvement of public employment service in finding the current job,

- permanency of the job (and reasons),
- duration of temporary job or work contract of limited duration,
- full-time/part-time distinction (and reasons),
- contract with a temporary work agency,
- working at home;

(d) hours worked:

- number of hours per week usually worked,
- number of hours actually worked,
- number of hours of overtime in the reference week,
- main reason for hours actually worked being different from usual hours;’

‘(g) search for employment:

- type of employment sought,
- duration of search for employment,
- situation of person immediately before starting to seek employment,
- registration at public employment office and whether receiving benefits,
- for person not seeking employment, willingness to work,
- reasons why person has not sought work,
- lack of care facilities.’

2. The following point is added to paragraph 1:

‘(n) atypical working times:

- shift work,
- evening work,
- night work,
- Saturday work,
- Sunday work.’

3. Paragraph 2, third indent, is replaced by the following:

- ‘— the volume of an ad hoc module shall be limited to 11 variables.’

4. The following paragraph shall be added:

‘4. On a proposal from the Commission, a list of variables, hereinafter referred to as “structural variables”, may be identified from among the survey characteristics specified in paragraph 1 which need to be surveyed only as annual averages with reference to 52 weeks rather than as quarterly averages. This list of structural variables, the minimum sample size and the survey frequency will be drawn up in accordance with the procedure laid down in Article 8. Spain, Finland and the United Kingdom may survey the structural variables with reference to a single quarter during a transition period until the end of 2007.’

Article 2

This Regulation shall enter into force on the 20th day following its publication in the *Official Journal of the European Union*.

This Regulation shall be binding in its entirety and directly applicable in all Member States.

SECTION 5c: COMMISSION REGULATION 430/2005 OF THE EUROPEAN UNION

This regulation implements Council Regulation (EC) No 577/98 on the organisation of a labour force sample survey in the Community concerning the codification to be used for data transmission from 2006 onwards and the use of a sub-sample for the collection of data on structural variables.

Having regard to Council Regulation (EC) No 577/98 of 9 March 1998 on the organisation of a labour force sample survey in the Community, and in particular Articles 3, 4 and 4 thereof, Whereas:

(1) In accordance with Article 4 of Regulation (EC) No 577/98 implementing measures are necessary in order to define the codification of the variables to be used for the data transmission.

(2) Under Article 4 of Regulation (EC) No 577/98 a list of variables, hereinafter referred to as structural variables, may be identified from among the survey characteristics which need to be surveyed only as annual averages with reference to 52 weeks rather than as quarterly averages. Therefore the conditions for the use of a sub-sample for the collection of data on structural variables should be laid down.

(3) In view of the importance of data on employment and unemployment, the totals for these indicators should be consistent whether they are produced from the annual sub-sample or on the basis of an annual average of the four quarterly full samples.

(4) In view of the importance of data collected in ad hoc modules, this information should be combinable with any other variable from the survey.

(5) The measures provided for in this Regulation are in accordance with the opinion of the Statistical Programme Committee established by Council Decision 89/382/EEC, Euratom, has adopted this regulation:

Article 1

The conditions for the use of a sub-sample for the collection of data on structural variables are laid down (below)

Article 2

The codes for the variables to be used for data transmission for the years 2006 onwards are laid down in Annex II.

Article 3

This Regulation shall enter into force on the twentieth day following that of its publication in the *Official Journal of the European Union*.

This Regulation shall be binding in its entirety and directly applicable in all Member States.

Conditions for the use of a sub-sample for the collection of data on structural variables

1. Yearly/quarterly variables

The word 'yearly' in the 'Periodicity' column of the Codification laid down in the next section, identifies structural variables which optionally need only to be surveyed as annual averages, using a sub-sample of independent observations with reference to 52 weeks, rather than as quarterly averages. Core variables to be surveyed each quarter are identified as 'quarterly'.

2. Representativeness of the results

For structural variables, the relative standard error (without taking design effect into account) of any yearly estimate representing 1 % or more of the working age population shall not exceed:

- (a) 9 % for countries with a population between 1 million and 20 million inhabitants and
- (b) 5 % for countries with a population of 20 million or more.

Countries with less than 1 million inhabitants are exempted from these precision requirements and structural variables should be collected for the total sample unless the sample meets requirements expressed in (a).

For countries using a sub-sample for data collection on structural variables, if more than one wave is used, the total sub-sample used shall consist of independent observations.

3. Consistency of totals

Consistency between annual sub-sample totals and full sample annual averages shall be ensured for employment, unemployment and inactive population by sex and for the following age groups: 15 to 24, 25 to 34, 35 to 44, 45 to 54, 55 +.

4. Ad hoc modules

The sample used to collect information on ad hoc modules shall also provide information on structural variables.

SECTION 5d: COMMISSION REGULATION 377/2008 OF THE EUROPEAN UNION

This regulation implements Council Regulation (EC) No 577/98 on the organisation of a labour force sample survey in the Community as regards the codification to be used for data transmission from 2009 onwards, the use of a sub-sample for the collection of data on structural variables and the definition of the reference quarters.

Having regard to Council Regulation (EC) No 577/98 of 9 March 1998 on the organisation of a labour force sample survey in the Community¹, and in particular Articles 1 and 4(3) thereof, Whereas:

(1) Article 1 of Regulation (EC) No 577/98 requires that, in the case of a continuous survey, a list of the weeks making up the reference quarters for the survey is drawn up by the Commission.

(2) In accordance with Article 4(3) of Regulation (EC) No 577/98, implementing measures are necessary in order to define the codification of the variables to be used for the data transmission.

(3) Under Article 4(4) of Regulation (EC) No 577/98, a list of variables, hereinafter referred to as structural variables, may be identified from among the survey characteristics which need to be surveyed only as annual averages with reference to 52 weeks rather than as quarterly averages. Therefore, the conditions for the use of a sub-sample for the collection of data on structural variables should be laid down.

(4) In view of the importance of data on employment and unemployment, the totals for these indicators should be consistent whether they are produced from the annual sub-sample or on the basis of an annual average of the four quarterly full samples.

(5) In view of the importance of data collected in ad hoc modules, this information should be combinable with any other variable from the survey.

(6) Regulation (EC) No 577/98 as amended by Regulation (EC) No 1372/2007 of the European Parliament and of the Council makes the transmission of the variable 'wages from the main job' compulsory. Therefore, the codification of the variables should be amended.

(7) Commission Regulation (EC) No 430/2005 implementing Council Regulation (EC) No 577/98 on the organisation of a labour force sample survey in the Community concerning the codification to be used for data transmission from 2006 onwards and the use of a sub-sample for the collection of data on structural variables² defines the codification to be used for the data transmission from 2006 onwards. However, it is necessary to amend the coding scheme from 2009 onwards in order to take account of changes in two variables (field of highest level of education or training successfully completed and monthly pay from main job), to adapt the transmission columns accordingly and to correct some filter errors and omissions for other

¹OJ L 77, 14.3.1998, p. 3. Regulation last amended by Regulation (EC) No 1372/2007 of the European Parliament and of the Council (OJ L 315, 3.12.2007, p. 42)

² OJ L 71, 17.3.2005, p. 36. Regulation last amended by Regulation (EC) No 973/2007 (OJ L 216, 21.8.2007, p. 10).

variables. Commission Regulation (EC) No 430/2005 should therefore be repealed with effect from 1 January 2009.

(8) The measures provided for in this Regulation are in accordance with the opinion of the Statistical Programme Committee established by Council Decision 89/382/EEC, Euratom³, has adopted this regulation:

Article 1

The conditions for the use of a sub-sample for the collection of data on structural variables are laid down in Annex I.

Article 2

The definition of the reference quarters to be applied from 2009 is laid down in Annex II.

Article 3

The codes for the variables to be used for the data transmission for the years 2009 onwards are laid down in Annex III.

Article 4

Regulation (EC) No 430/2005 shall be repealed with effect from 1 January 2009.

Article 5

This Regulation shall enter into force on the twentieth day following that of its publication in the *Official Journal of the European Union*.

It shall apply from 1 January 2009. This Regulation shall be binding in its entirety and directly applicable in all Member States.

ANNEX I

1. Yearly/quarterly variables

The word 'yearly' in the 'Periodicity' column of the Codification laid down in Annex III identifies structural variables which optionally need only to be surveyed as annual averages, using a sub-sample of independent observations with reference to 52 weeks, rather than as quarterly averages. Core variables to be surveyed each quarter are identified as 'quarterly'.

2. Representativeness of the results

For structural variables, the relative standard error (without taking design effect into account) of any yearly estimate representing 1 % or more of the working-age population shall not exceed:

(a) 9 % for countries with a population between 1 million and 20 million inhabitants and,

(b) 5 % for countries with a population of 20 million or more.

Countries with fewer than 1 million inhabitants are exempted from these precision requirements, and structural variables should be collected for the total sample unless the sample meets the requirements set out in (a).

For countries using a sub-sample for data collection on structural variables, if more than one wave is used, the total subsample used shall consist of independent observations.

³ OJ L 181, 28.6.1989, p. 47

3. Consistency of totals

Consistency between annual sub-sample totals and full-sample annual averages shall be ensured for employment, unemployment and inactive population by sex and for the following age groups: 15 to 24, 25 to 34, 35 to 44, 45 to 54, 55 +.

4. Ad hoc modules

The sample used to collect information on ad hoc modules shall also provide information on structural variables.

ANNEX II

(a) Quarters of each year refer to the 12 months of the year, so that January, February and March belong to the first quarter, April, May and June to the second quarter, July, August and September to the third quarter and October, November and December to the fourth quarter.

(b) The reference weeks are allocated to the reference quarters so that a week belongs to the quarter as defined in (a) to which at least four days of that week belong, unless this results in the first quarter of the year consisting of only 12 weeks. When that occurs, the quarters of the year in question will be formed by consecutive blocks of 13 weeks.

(c) When, according to (b), a quarter consists of 14 weeks instead of 13 weeks the Member States should attempt to spread the sample over all of the 14 weeks.

(d) If it is not feasible to spread the sample to cover all 14 weeks of the quarter, the Member State concerned may skip one week of that quarter (i.e. not cover it). The week to be skipped should be typical with regard to unemployment, employment and average actual hours worked and should be part of a month containing five Thursdays.

(e) The first quarter of 2009 shall start on Monday, 29 December 2008. Until the end of 2011, Member States running the Labour Force Survey along with other surveys as one single integrated survey may define the start of reference quarters one week earlier than laid down in (a), (b) and (e).

SECTION 6: EU LABOUR FORCE SURVEY - DATA CODIFICATION 2009

Eurostat Name	Column	Periodicity	Code	Description	Filter/Remarks
DEMOGRAPHIC BACKGROUND					
HHSEQNUM	1/2	QUARTERLY		<i>Sequence number in the household (it should remain the same for all waves)</i>	everybody
			01-98	Two-digit sequence number allocated to each member of the household	
HHLINK	3	YEARLY		<i>Relationship to reference person in the household</i>	HHTYPE =1,3
			1	Reference person	
			2	Spouse (or cohabiting partner) of reference person	
			3	Child of reference person (or of his/her spouse or cohabiting partner)	
			4	Ascendant relative of reference person (or of his/her spouse or cohabiting partner)	
			5	Other relative	
			6	Other	
			9	Not applicable (HHTYPE ≠1,3)	
HHSPOU	4/5	YEARLY		<i>Sequence number of spouse or cohabiting partner</i>	HHTYPE =1,3
			01-98	Sequence number of spouse or cohabiting partner in the household	
			99	Not applicable (person does not belong to a private household, or has no partner, or the partner does not belong to this private household)	
HHFATH	6/7	YEARLY		<i>Sequence number of father</i>	HHTYPE =1,3
			01-98	Sequence number of father in the household	
			99	Not applicable (person does not belong to a private household, or the father does not belong to this private household)	
HHMOTH	8/9	YEARLY		<i>Sequence number of mother</i>	HHTYPE =1,3
			01-98	Sequence number of mother in the household	
			99	Not applicable (person does not belong to a private household, or the mother does not belong to this private household)	
SEX	10	QUARTERLY		Sex	everybody
			1	Male	
			2	Female	
YEARBIR	11/14	QUARTERLY		<i>Year of birth</i>	everybody
				The 4 digits of year of birth are entered	
DATEBIR	15	QUARTERLY		<i>Date of birth in relation to the end of reference period</i>	everybody
			1	Person's birthday falls between 1 January and the end of the reference week	
			2	Person's birthday falls after the end of the reference week	
MARSTAT	16	YEARLY		<i>Marital status</i>	everybody
			1	Single	
			2	Married	
			3	Widowed	
			4	Divorced or legally separated	
			blank	No answer	
NATIONAL	17/18	QUARTERLY		<i>Nationality</i>	everybody

Labour Force Survey - United Kingdom

				For coding, see ISO country classification (Annex IV)	
YEARESID	19/20	YEARLY		<i>Years of residence in this Country</i>	Everybody
			00	Born in this Country	
			01-99	Number of years of residence in this country	
			blank	No answer	
COUNTRYB	21/22	QUARTERLY		<i>Country of birth</i>	YEARESID≠00
				For coding, see ISO country classification (Annex IV)	
			99	Not applicable (Col.19/20=00)	
			blank	No answer	
PROXY	23	QUARTERLY		<i>Nature of participation in the survey</i>	everybody aged 15 years or more
			1	Direct participation	
			2	Participation via another member of the household	
			9	Not applicable (child less than 15 years old)	
			blank	No answer	
				LABOUR STATUS	
WSTATOR	24	QUARTERLY		<i>Labour status during the reference week</i>	everybody aged 15 years or more
			1	Did any work for pay or profit during the reference week - one hour or more (including family workers but excluding conscripts on compulsory military or community service)	
			2	Was not working but had a job or business from which he/she was absent during the reference week (including family workers but excluding conscripts on compulsory military or community service)	
			3	Was not working because on lay-off	
			4	Was a conscript on compulsory military or community service	
			5	Other (15 years or more) who neither worked nor had a job or business during the reference week	
			9	Not applicable (child less than 15 years old)	
NOWKREAS	25/26	QUARTERLY		<i>Reason for not having worked at all though having a job</i>	WSTATOR=2
			00	Bad weather	
			01	Slack work for technical or economic reasons	
			02	Labour dispute	
			03	School education or training	
			04	Own illness, injury or temporary disability	
			05	Maternity leave	
			06	Parental leave	
			07	Holidays	
			08	Compensation leave (within the framework of working time banking or an annualised hours contract)	
			09	Other reasons (e.g. personal or family responsibilities)	
			99	Not applicable (WSTATOR=1,3-5,9)	
				EMPLOYMENT CHARACTERISTICS OF THE MAIN JOB	
STAPRO	27	QUARTERLY		<i>Professional status</i>	WSTATOR=1,2
			1	Self-employed with employees	
			2	Self-employed without employees	
			3	Employee	
			4	Family worker	
			9	Not applicable (WSTATOR=3-5,9)	
			blank	No answer	

Labour Force Survey - United Kingdom

SIGNISAL	28	QUARTERLY	1 2 3 4 9	<i>Continuing receipt of the wage or salary</i> Absent for up to and including 3 months Absent for more than 3 months and receiving a wage, salary or social allowances corresponding to half or more of the salary Absent for more than 3 months and receiving a wage, salary or social allowances corresponding to less than half of the salary Don't know Not applicable ((WSTATOR ≠2 or NOWKREAS = 04 or NOWKREAS = 05 or STAPRO ≠3) and WSTATOR ≠ 3)	(WSTATOR = 2 and NOWKREAS ≠04 and NOWKREAS≠ 05 and STAPRO=3) or WSTATOR = 3
NACE3D	29/31	QUARTERLY	000 blank	<i>Economic activity of the local unit</i> NACE Rev. 2 coded at 2 or if possible 3 digit level Not applicable (WSTATOR=3-5,9) No answer	WSTATOR=1,2
ISCO4D	32/35	QUARTERLY	9999 blank	<i>Occupation</i> ISCO-88 (COM) coded at 3 or if possible 4 digit level Not applicable (WSTATOR=3-5,9) No answer	WSTATOR=1,2
SUPVISOR	36	YEARLY	1 2 9 blank	<i>Supervisory responsibilities</i> Yes No STAPRO ≠ 3 No answer	STAPRO = 3
SIZEFIRM	37/38	YEARLY	01-10 11 12 13 14 15 99 blank	<i>Number of persons working at the local unit</i> Exact number of persons, if between 1 and 10 11 to 19 persons 20 to 49 persons 50 persons or more Do not know but less than 11 persons Do not know but more than 10 persons Not applicable (STAPRO=2,9) No answer	STAPRO=1,3,4, blank
COUNTRYW	39/40	QUARTERLY	99 blank	<i>Country of place of work</i> For coding, see ISO country classification (Annex IV) Not applicable (WSTATOR=3-5,9) No answer	WSTATOR=1,2
REGIONW	41/42	QUARTERLY	99 blank	<i>Region of place of work</i> NUTS 2 Not applicable (WSTATOR=3-5,9) No answer	WSTATOR=1,2
YSTARTWK	43/46	QUARTERLY	9999 blank	<i>Year in which person started working for this employer or as self-employed</i> Enter the 4 digits of the year concerned Not applicable (WSTATOR=3-5,9) No answer	WSTATOR=1,2
MSTARTWK	47/48	QUARTERLY	01-12 99 blank	<i>Month in which person started working for this employer or as self-employed</i> Enter the number of the month concerned Not applicable (YSTARTWK=9999,blank or REFYEAR-YSTARTWK>2) No answer	YSTARTWK≠99 99, blank & REFYEAR - YSTARTWK≤ 2
WAYJFOUN	49	YEARLY		<i>Involvement of the public employment office at any moment in finding the present job</i>	STAPRO = 3 & has started this job

Labour Force Survey - United Kingdom

			0	No	in the last 12 months
			1	Yes	
			9	STAPRO ≠ 3 or has started this job more than 1 year ago	
			blank	No answer	
FTPT	50	QUARTERLY		<i>Full-time / Part-time distinction</i>	WSTATOR=1,2
			1	Full-time job	
			2	Part-time job	
			9	WSTATOR≠1,2	
			blank	No answer	
FTPTREAS	51	YEARLY		<i>Reasons for the part-time work</i>	FTPT=2
				Part-time job is taken because:	
			1	Person is undergoing school education or training	
			2	Of own illness or disability	
			3	Looking after children or incapacitated adults	
			4	Other personal or family reasons	
			5	Person could not find a full-time job	
			6	Of other reasons	
			9	Not applicable (FTPT≠2)	
			blank	No answer	
TEMP	52	QUARTERLY		<i>Permanency of the job</i>	STAPRO=3
			1	Person has a permanent job or work contract of unlimited duration	
			2	Person has temporary job/work contract of limited duration	
			9	Not applicable (STAPRO≠3)	
			blank	No answer	
TEMPREAS	53	YEARLY		<i>Reasons for having a temporary job/work contract of limited duration</i>	TEMP =2
				Person has temporary job/work contract of limited duration because:	
			1	It is a contract covering a period of training (apprentices, trainees, research assistants, etc.)	
			2	Person could not find a permanent job	
			3	Person did not want a permanent job	
			4	It is a contract for a probationary period	
			9	Not applicable (TEMP≠2)	
			blank	No answer	
TEMPDUR	54	QUARTERLY		<i>Total duration of temporary job or work contract of limited duration</i>	TEMP=2
			1	Less than one month	
			2	1 to 3 months	
			3	4 to 6 months	
			4	7 to 12 months	
			5	13 to 18 months	
			6	19 to 24 months	
			7	25 to 36 months	
			8	More than 3 years	
			9	Not applicable (TEMP≠2)	
			blank	No answer	
TEMPAGCY	55	YEARLY		<i>Contract with a temporary employment agency</i>	STAPRO=3
			0	No	
			1	Yes	
			9	Not applicable (STAPRO≠3)	
			blank	No answer	
				ATYPICAL WORK	

Labour Force Survey - United Kingdom

SHIFTWK	56	YEARLY		<i>Shift work</i>	STAPRO=3
			1	Person does shift work	
			3	Person never does shift work	
			9	Not applicable (STAPRO ≠ 3)	
			blank	No answer	
EVENWK	57	YEARLY		<i>Evening work</i>	WSTATOR=1 or WSTATOR=2
			1	Person usually works in the evening	
			2	Person sometimes works in the evening	
			3	Person never works in the evening	
			9	Not applicable (WSTATOR=3-5,9)	
			blank	No answer	
NIGHTWK	58	YEARLY		<i>Night work</i>	WSTATOR=1 or WSTATOR=2
			1	Person usually works at night	
			2	Person sometimes works at night	
			3	Person never works at night	
			9	Not applicable (WSTATOR=3-5,9)	
			blank	No answer	
SATWK	59	YEARLY		<i>Saturday work</i>	WSTATOR=1 or WSTATOR=2
			1	Person usually works on Saturdays	
			2	Person sometimes works on Saturdays	
			3	Person never works on Saturdays	
			9	Not applicable (WSTATOR=3-5,9)	
			blank	No answer	
SUNWK	60	YEARLY		<i>Sunday work</i>	WSTATOR=1 or WSTATOR=2
			1	Person usually works on Sundays	
			2	Person sometimes works on Sundays	
			3	Person never works on Sundays	
			9	Not applicable (WSTATOR=3-5,9)	
			blank	No answer	
				HOURS WORKED	
HWUSUAL	61/62	QUARTERLY		<i>Number of hours per week usually worked in the main job</i>	WSTATOR=1,2
			00	Usual hours cannot be given because hours worked vary considerably from week to week or from month to month	
			01-98	Number of hours usually worked in the main job	
			99	Not applicable (WSTATOR=3-5,9)	
			blank	No answer	
HWACTUAL	63/64	QUARTERLY		<i>Number of hours actually worked during the reference week in the main job</i>	WSTATOR=1,2
			00	Person having a job or business and not having worked at all in the main activity during the reference week (WSTATOR=2)	
			01-98	Number of hours actually worked in the main job during the reference week	
			99	Not applicable (WSTATOR=3-5,9)	
			blank	No answer	
HWOVERP	65/66	QUARTERLY		<i>Paid overtime in the reference week in the main job</i>	STAPRO=3
			00-98	Number of paid overtime hours	
			99	Not applicable (STAPRO≠3)	
			blank	No answer	
HWOVERPU	67/68	QUARTERLY		<i>Unpaid overtime in the reference week in the main job</i>	STAPRO=3
			00-98	Number of unpaid overtime hours	
			99	Not applicable (STAPRO≠3)	

Labour Force Survey - United Kingdom

HOURREAS	69/70	QUARTERLY	blank	No answer	
				<i>Main reason for hours actually worked during the reference week being different from the person's usual hours</i>	
				Person has worked more than usual due to:	
			01	- variable hours (e.g. flexible working hours)	
			16	- overtime	
			02	- other reasons	
				Person has worked less than usual due to:	
			03	- bad weather	
			04	- slack work for technical or economic reasons	
			05	- labour dispute	
			06	- education or training	
			07	- variable hours (e.g. flexible working hours)	
			08	- own illness, injury or temporary disability	
			09	- maternity or parental leave	
			10	- special leave for personal or family reasons	
			11	- annual holidays	
			12	- bank holidays	
			13	- start of/change in job during reference week	
			14	- end of job without taking up a new one during reference week	
			15	- other reasons	
			97	Person having worked usual hours during the reference week (HWUSUAL=HWACTUAL=01-98)	
			98	Person whose hours vary considerably from week to week or month to month and who did not state a reason for a divergence between the actual and usual hours (HWUSUAL=00 & HOURREAS#01-16)	
			99	Not applicable (WSTATOR=2-5,9 or HWUSUAL=blank or HWACTUAL= blank)	
			blank	No answer	
WISHMORE	71	QUARTERLY		<i>Wish to work usually more than the current number of hours</i>	(WSTATOR=1 or WSTATOR=2)
			0	No	
			1	Yes	
			9	Not applicable (WSTATOR=3-5, 9)	
			blank	No answer	
WAYMORE	72	YEARLY		<i>Way how person wants to work more hours</i>	WISHMORE=1
			1	Through an additional job	
			2	Through a job working more hours than the present job	
			3	Only within the present job	
			4	In any of the above ways	
			9	Not applicable (WISHMORE≠1)	
			blank	No answer	
HWWISH	73/74	QUARTERLY		<i>Number of hours that the person would like to work in total</i>	WSTATOR=1 or WSTATOR=2
			01-98	Number of hours wished to work in total	
			99	Not applicable (WSTATOR=3-5,9)	
			blank	No answer	
HOMEWK	75	YEARLY		<i>Working at home</i>	WSTATOR=1 or WSTATOR=2
			1	Person usually works at home	
			2	Person sometimes works at home	
			3	Person never works at home	
			9	Not applicable (WSTATOR=3-5,9)	
			blank	No answer	

Labour Force Survey - United Kingdom

LOOKOJ	76	QUARTERLY	<p><i>Looking for another job</i></p> <p>0 Person is not looking for another job 1 Person is looking for another job 9 Not applicable (WSTATOR=3-5,9) blank No answer</p>	WSTATOR=1 or WSTATOR=2
LOOKREAS	77	YEARLY	<p><i>Main reason for looking for another job</i></p> <p>1 - risk or certainty of loss or termination of present job 2 - actual job is considered as a transitional job 3 - seeking an additional job to add more hours to those worked in present job 4 - seeking a job with more hours worked than in present job 5 - seeking a job with fewer hours worked than in present job 6 - wish to have better working conditions (e.g. pay, working or travel time, quality of work) 7 - of other reasons 9 Not applicable (LOOKOJ ≠ 1) blank No answer</p> <p>SECOND JOB</p>	LOOKOJ = 1
EXIST2J	78	QUARTERLY	<p><i>Existence of more than one job or business</i></p> <p>1 Person had only one job or business during the reference week 2 Person had more than one job or business during the reference week (not due to change of job or business) 9 Not applicable (WSTATOR=3-5,9) blank No answer</p>	WSTATOR=1 or WSTATOR=2
STAPRO2J	79	QUARTERLY	<p><i>Professional status (in the second job)</i></p> <p>1 Self-employed with employees 2 Self-employed without employees 3 Employee 4 Family worker 9 Not applicable (EXIST2J=1,9 blank) blank No answer</p>	EXIST2J=2
NACE2J2D	80/81	QUARTERLY	<p><i>Economic activity of the local unit (in the second job)</i></p> <p>NACE Rev. 2 00 Not applicable (EXIST2J=1,9,blank) blank No answer</p>	EXIST2J=2
HWACTUA2	82/83	QUARTERLY	<p><i>Number of hours actually worked during the reference week in the second job</i></p> <p>00 Person not having worked in the second job during the reference week 01-98 Number of hours actually worked in the second job during the reference week 99 Not applicable (EXIST2J=1,9, blank) blank No answer</p>	EXIST2J=2
EXISTPR	84	QUARTERLY	<p>PREVIOUS WORK EXPERIENCE OF PERSON NOT IN EMPLOYMENT</p> <p><i>Existence of previous employment experience</i></p> <p>0 Person has never been in employment (purely occasional work, such as vacation work, compulsory military or community service are not to be considered as employment) 1 Person has already been in employment (purely occasional work, such as vacation work, compulsory military or community service are not to be considered as</p>	WSTATOR=3-5

Labour Force Survey - United Kingdom

YEARPR	85/88	QUARTERLY	9 blank	employment) Not applicable (WSTATOR=1,2 or 9) No answer <i>Year in which person last worked</i> Enter the 4 digits of the year in which person last worked	EXISTPR=1
MONTHPR	89/90	QUARTERLY	9999 blank	Not applicable (EXISTPR=0,9,blank) No answer <i>Month in which person last worked</i> Enter the number of the month in which person last worked	YEARPR≠9999, blank & REFYEAR- YEARPR ≤ 2
LEAVREAS	91/92	YEARLY	01-12 99 blank	Not applicable (YEARPR=9999, blank or REFYEAR- YEARPR>2) No answer <i>Main reason for leaving last job or business</i>	EXISTPR=1 and REFYEAR - YEARPR<8
STAPROPR	93	QUARTERLY only if having worked in the last 12 months YEARLY otherwise	00 01 02 03 04 05 06 07 08 09 99 blank	Dismissed or made redundant A job of limited duration has ended Looking after children or incapacitated adults Other personal or family responsibilities Own illness or disability Education or training Early retirement Normal retirement Compulsory military or community service Other reasons Not applicable (EXISTPR=0,9,blank, or EXISTPR=1 and did not work in last 8 years) No answer <i>Professional status in last job</i>	EXISTPR=1 and REFYEAR - YEARPR<8
NACEPR2D	94/95	QUARTERLY if having worked in the last 12 months, YEARLY otherwise	1 2 3 4 9 blank	Self-employed with employees Self-employed without employees Employee Family worker Not applicable (EXISTPR=0,9,blank, or EXISTPR=1 and did not work in last 8 years) No answer <i>Economic activity of the local unit in which person last worked</i> NACE Rev. 2	EXISTPR=1 and REFYEAR - YEARPR<8
ISCOPR3D	96/98	QUARTERLY if having worked in the last 12 months, YEARLY otherwise	00 blank 999 blank	Not applicable (EXISTPR=0,9,blank, or EXISTPR=1 and did not work in last 8 years) No answer <i>Occupation of last job</i> ISCO-88 (COM) Not applicable (EXISTPR=0,9,blank, or EXISTPR=1 and did not work in last 8 years) No answer	EXISTPR=1 and REFYEAR - YEARPR<8
SEEKWORK	99	QUARTERLY		SEARCH FOR EMPLOYMENT <i>Seeking employment during previous four weeks</i> 1 Person has already found a job which will start within a period of at most 3 months 2 Person has already found a job which will start in more than 3 months and is not seeking employment 3 Person is not seeking employment and has not found any job to start later 4 Person is seeking employment	(WSTATOR=3-5 or SIGNISAL=3) and Age<75

Labour Force Survey - United Kingdom

SEEKREAS	100	YEARLY	9	Not applicable (WSTATOR=1,2 or 9 and SIGNISAL ≠ 3) or Age equal or greater than 75 <i>Reasons for not searching an employment</i> <i>Person is not seeking employment because:</i>	SEEKWORK=3
			1	- awaiting recall to work (persons on lay-off)	
			2	- of own illness or disability	
			3	- looking after children or incapacitated adults	
			4	- of other personal or family responsibilities	
			5	- of education or training	
			6	- of retirement	
			7	- of belief that no work is available	
			8	- of other reasons	
			9	Not applicable (SEEKWORK≠3)	
SEEKTYPE	101	QUARTERLY	blank	No answer	
				<i>Type of employment sought (or found)</i> The employment sought (for SEEKWORK=1, 2 the employment found) is:	SEEKWORK=1, 2, 4 or LOOKOJ=1
			1	as self-employed	
				as employee :	
			2	- and only full-time job is looked for (or has already been found)	
			3	- and full-time job is sought, but if not available, part-time job will be accepted	
			4	- and part-time job is sought, but if not available, full-time job will be accepted	
			5	- and only part-time job is looked for (or has already been found)	
			6	- and person did not state whether full-time or part-time job is looked for (or has already been found)	
			9	Not applicable (SEEKWORK ≠ 1,2,4 and LOOKOJ ≠ 1)	
			Blank	No answer	
SEEKDUR	102	QUARTERLY		<i>Duration of search for employment</i>	SEEKWORK=1, 4 or LOOKOJ=1
			0	Search not yet started	
			1	Less than 1 month	
			2	1-2 months	
			3	3-5 months	
			4	6-11 months	
			5	12-17 months	
			6	18-23 months	
			7	24-47 months	
			8	4 years or longer	
			9	Not applicable (SEEKWORK ≠ 1,4 and LOOKOJ ≠ 1)	
			Blank	No answer	
				METHODS USED DURING PREVIOUS FOUR WEEKS TO FIND WORK	
METHODA	103	QUARTERLY		<i>Contacted public employment office to find work</i>	SEEKWORK=4 or LOOKOJ=1
			0	No	
			1	Yes	
			9	Not applicable (SEEKWORK ≠ 4 and LOOKOJ ≠ 1)	
METHODB	104	QUARTERLY		<i>Contacted private employment agency to find work</i>	SEEKWORK=4 or LOOKOJ=1
			0	No	
			1	Yes	
			9	Not applicable (SEEKWORK ≠ 4 and LOOKOJ ≠ 1)	
METHODC	105	QUARTERLY		<i>Applied to employers directly</i>	SEEKWORK=4 or LOOKOJ=1
			0	No	

Labour Force Survey - United Kingdom

METHODD	106	QUARTERLY	1	Yes	SEEKWORK=4 or LOOKOJ=1
			9	Not applicable (SEEKWORK ≠ 4 and LOOKOJ ≠ 1)	
			0	<i>Asked friends, relatives, trade unions, etc.</i>	
			1	No	
METHODE	107	QUARTERLY	1	Yes	SEEKWORK=4 or LOOKOJ=1
			9	Not applicable (SEEKWORK ≠ 4 and LOOKOJ ≠ 1)	
			0	<i>Inserted or answered advertisements in newspapers or journals</i>	
			1	No	
METHODF	108	QUARTERLY	1	Yes	SEEKWORK=4 or LOOKOJ=1
			9	Not applicable (SEEKWORK ≠ 4 and LOOKOJ ≠ 1)	
			0	<i>Studied advertisements in newspapers or journals</i>	
			1	No	
METHODG	109	QUARTERLY	1	Yes	SEEKWORK=4 or LOOKOJ=1
			9	Not applicable (SEEKWORK ≠ 4 and LOOKOJ ≠ 1)	
			0	<i>Took a test, interview or examination</i>	
			1	No	
METHODH	110	QUARTERLY	1	Yes	SEEKWORK=4 or LOOKOJ=1
			9	Not applicable (SEEKWORK ≠ 4 and LOOKOJ ≠ 1)	
			0	<i>Looked for land, premises or equipment</i>	
			1	No	
METHODI	111	QUARTERLY	1	Yes	SEEKWORK=4 or LOOKOJ=1
			9	Not applicable (SEEKWORK ≠ 4 and LOOKOJ ≠ 1)	
			0	<i>Looked for permits, licences, financial resources</i>	
			1	No	
METHODJ	112	QUARTERLY	1	Yes	SEEKWORK=4 or LOOKOJ=1
			9	Not applicable (SEEKWORK ≠ 4 and LOOKOJ ≠ 1)	
			0	<i>Awaiting the results of an application for a job</i>	
			1	No	
METHODK	113	QUARTERLY	1	Yes	SEEKWORK=4 or LOOKOJ=1
			9	Not applicable (SEEKWORK ≠ 4 and LOOKOJ ≠ 1)	
			0	<i>Waiting for a call from a public employment office</i>	
			1	No	
METHODL	114	QUARTERLY	1	Yes	SEEKWORK=4 or LOOKOJ=1
			9	Not applicable (SEEKWORK ≠ 4 and LOOKOJ ≠ 1)	
			0	<i>Awaiting the results of a competition for recruitment to the public sector</i>	
			1	No	
METHODM	115	QUARTERLY	1	Yes	SEEKWORK=4 or LOOKOJ=1
			9	Not applicable (SEEKWORK ≠ 4 and LOOKOJ ≠ 1)	
			0	<i>Other method used</i>	
			1	No	
WANTWORK	116	QUARTERLY	9	Not applicable (SEEKWORK ≠ 4 and LOOKOJ ≠ 1)	SEEKWORK=3
			Blank	<i>Willingness to work for person not seeking employment</i>	
			1	Person is not seeking employment:	
			2	- but would nevertheless like to have work	
			9	- and does not want to have work	
			Blank	Not applicable (SEEKWORK≠3)	
AVAILABLE	117	QUARTERLY	Blank	No answer	SEEKWORK=1,
			Blank	<i>Availability to start working within two weeks</i>	

Labour Force Survey - United Kingdom

				<p>If work were found now:</p> <p>1 Person could start to work immediately (within 2 weeks)</p> <p>2 Person could not start to work immediately (within 2 weeks)</p> <p>9 Not applicable (SEEKWORK≠1,4 and WANTWORK≠1,blank and WISHMORE≠1)</p>	<p>4 or WANTWORK=1, blank or WISHMORE=1</p>
AVAIAREAS	118	YEARLY		<p><i>Reasons for not being available to start working within 2 weeks</i></p> <p>Person could not start to work immediately (within 2 weeks) because:</p> <p>1 - he/she must complete education or training</p> <p>2 - he/she must complete compulsory military or community service</p> <p>3 - he/she cannot leave present employment within two weeks due to period of notice</p> <p>4 - of personal or family responsibilities (including maternity)</p> <p>5 - of own illness or incapacity</p> <p>6 - of other reasons</p> <p>9 Not applicable (AVAILBLE≠2)</p>	AVAILBLE=2
PRESEEK	119	YEARLY		<p>blank No answer</p> <p><i>Situation immediately before person started to seek employment (or was waiting for new job to start)</i></p> <p>1 Person was working (including apprentices, trainees)</p> <p>2 Person was in full-time education (excluding apprentices, trainees)</p> <p>3 Person was conscript on compulsory military or community service</p> <p>4 Person had domestic/family responsibilities</p> <p>5 Other (e.g. retired)</p> <p>9 Not applicable (SEEKWORK=3, 9)</p>	SEEKWORK=1, 2, 4
NEEDCARE	120	YEARLY		<p>blank No answer</p> <p><i>Need for care facilities</i></p> <p>Person is not searching for a job or is working part time because:</p> <p>1 suitable care services for children are not available or affordable</p> <p>2 suitable care services for ill, disabled, elderly are not available or affordable</p> <p>3 Suitable care services for both children and ill, disabled and elderly are not available or affordable.</p> <p>4 Care facilities do not influence decision for working part time or not searching for a job</p> <p>9 Not applicable (FTPTREAS≠3 and SEEKREAS ≠3)</p>	FTPTREAS=3 or SEEKREAS =3
REGISTER	121	YEARLY		<p>Blank No answer</p> <p><i>Registration at a public employment office</i></p> <p>1 Person is registered at a public employment office and receives benefit or assistance</p> <p>2 Person is registered at a public employment office but does not receive benefit or assistance</p> <p>3 Person is not registered at a public employment office but receives benefit or assistance</p> <p>4 Person is not registered at a public employment office and does not receive benefit or assistance</p> <p>9 Not applicable (person aged less than 15 years or older than 75)</p>	everybody aged 15 to 74 years
MAINSTAT (optional)	122	YEARLY		<p>MAIN LABOUR STATUS</p> <p><i>Main status</i></p> <p>1 Carries out a job or profession, including unpaid work for</p>	everybody aged 15 years or more

Labour Force Survey - United Kingdom

			<p>a family business or holding, including an apprenticeship or paid traineeship, etc,</p> <p>2 Unemployed</p> <p>3 Pupil, student, further training, unpaid work experience</p> <p>4 In retirement or early retirement or has given up business</p> <p>5 Permanently disabled</p> <p>6 In compulsory military service</p> <p>7 Fulfilling domestic tasks</p> <p>8 Other inactive person</p> <p>9 Not applicable (child less than 15 years)</p> <p>blank No answer</p>	
EDUCSTAT	123	QUARTERLY	<p>EDUCATION AND TRAINING</p> <p><i>Student or apprentice in regular education during the last four weeks</i></p> <p>1 Has been a student or an apprentice</p> <p>3 Person in regular education but on holidays</p> <p>2 Has not been a student or apprentice</p> <p>9 Not applicable (child less than 15 years)</p> <p>blank No answer</p>	everybody aged 15 years or more
EDUCLEVL	124	QUARTERLY	<p><i>Level of this education or training</i></p> <p>1 ISCED 1</p> <p>2 ISCED 2</p> <p>3 ISCED 3</p> <p>4 ISCED 4</p> <p>5 ISCED 5</p> <p>6 ISCED 6</p> <p>9 Not applicable (EDUCSTAT = 2, 9, blank)</p> <p>blank No answer</p>	EDUCSTAT = 1 or 3
EDUCFILD (optional)	125/127	YEARLY	<p><i>Field of this education or training</i></p> <p>000 General programmes</p> <p>100 Teacher training and education science</p> <p>200 Humanities, languages and arts</p> <p>222 Foreign languages</p> <p>300 Social sciences, business and law</p> <p>400 Science, mathematics and computing</p> <p>420 Life science (including biology and environmental science)</p> <p>440 Physical science (including physics, chemistry and earth science)</p> <p>460 Mathematics and statistics</p> <p>481 Computer science</p> <p>482 Computer use</p> <p>500 Engineering, manufacturing and construction</p> <p>600 Agriculture and veterinary</p> <p>700 Health and welfare</p> <p>800 Services</p> <p>900 Unknown</p> <p>999 Not applicable (EDUCSTAT = 2, 9, blank or EDUCLEVL ≠ (3 to 6))</p> <p>blank No answer</p>	EDUCSTAT = 1 or 3 and EDUCLEVL = 3 to 6
COURATT	128	QUARTERLY	<p><i>Did you attend any courses, seminars, conferences or receive private lessons or instructions outside the regular education system (hereafter referred to as taught learning activities) within the last four weeks</i></p> <p>1 Yes</p> <p>2 No</p> <p>9 Not applicable (child less than 15 years)</p>	Everybody aged 15 years or more

Labour Force Survey - United Kingdom

COURLEN	129/131	QUARTERLY	blank	No answer	
				<i>Number of hours spent on all taught-learning activities within the last four weeks</i>	COURATT = 1
			3	Number of hours	
			digits		
			999	Not applicable (COURATT = 2, 9, blank)	
			blank	No answer	
COURPURP (optional)	132	YEARLY		<i>Purpose of the most recent taught learning activity</i>	COURATT = 1
			1	Mostly job related (professional)	
			2	Mostly personal/social	
			9	Not applicable (COURATT = 2, 9, blank)	
			blank	No answer	
COURFILD (optional)	133/135	YEARLY		<i>Field of the most recent taught learning activity</i>	COURATT = 1
			000	General programmes	
			100	Teacher training and education science	
			200	Humanities, languages and arts	
			222	Foreign languages	
			300	Social sciences, business and law	
			400	Science, mathematics and computing	
			420	Life science (including biology and environmental science)	
			440	Physical science (including physics, chemistry and earth science)	
			460	Mathematics and statistics	
			481	Computer science	
			482	Computer use	
			500	Engineering, manufacturing and construction	
			600	Agriculture and veterinary	
			700	Health and welfare	
			800	Services	
			900	Unknown	
			999	Not applicable (COURATT = 2, 9, blank)	
			blank	No answer	
COURWORH (optional)	136	YEARLY		<i>Did the most recent taught learning activity take place during paid working hours?</i>	COURATT = 1
			1	Only during paid working hours	
			2	Mostly during paid working hours	
			3	Mostly outside paid working hours	
			4	Only outside paid working hours	
			5	No job at that time	
			9	Not applicable (COURATT = 2, 9, blank)	
			blank	No answer	
HATLEVEL	137/138	QUARTERLY		<i>Highest level of education or training successfully completed</i>	Everybody aged 15 years or more
			00	No formal education or below ISCED 1	
			11	ISCED 1	
			21	ISCED 2	
			22	ISCED 3c (shorter than two years)	
			31	ISCED 3c (two years and more)	
			32	ISCED 3 a, b	
			30	ISCED 3 (without distinction a, b or c possible, 2 y+)	
			41	ISCED 4a, b	
			42	ISCED 4c	
			43	ISCED 4 (without distinction a, b or c possible)	
			51	ISCED 5b	
			52	ISCED 5a	

Labour Force Survey - United Kingdom

			60	ISCED 6	
			99	Not applicable (child less than 15 years)	
			Blank	No answer	
HATFIELD	139/141	YEARLY		<i>Field of highest level of education or training successfully completed</i>	HATLEVEL = 22 to 60
			000	General programmes ⁴	
			100	Teacher training and education science ¹	
			200	Humanities, languages and arts ¹	
			222	Foreign languages ¹	
			300	Social sciences, business and law ¹	
			400	Science, mathematics and computing ¹	
			420	Life science (including biology and environmental science) ¹	
			440	Physical science (including physics, chemistry and earth science) ¹	
			460	Mathematics and statistics ¹	
			481	Computer science	
			482	Computer use	
			500	Engineering, manufacturing and construction ¹	
			600	Agriculture and veterinary ¹	
			700	Health and welfare ¹	
			800	Services ¹	
			900	Unknown	
			999	Not applicable (HATLEVEL = 00, 11, 21, 99, Blank)	
			blank	No answer	
HATYEAR	142/145	YEARLY		<i>Year when highest level of education or training was successfully completed</i>	HATLEVEL = 11-60
				The 4 digits of year when highest level of education or training was successfully completed are entered	
			9999	Not applicable (HATLEVEL = 00, 99, blank)	
			blank	No answer	
				SITUATION ONE YEAR BEFORE SURVEY	
WSTAT1Y	146	YEARLY		<i>Situation with regard to activity one year before survey</i>	everybody aged 15 years or more
			1	Carries out a job or profession, including unpaid work for a family business or holding, including an apprenticeship or paid traineeship, etc,	
			2	Unemployed	
			3	Pupil, student, further training, unpaid work experience	
			4	In retirement or early retirement or has given up business	
			5	Permanently disabled	
			6	In compulsory military service	
			7	Fulfilling domestic tasks	
			8	Other inactive person	
			9	Not applicable (child less than 15 years)	
			blank	No answer	
STAPRO1Y	147	YEARLY		<i>Professional status one year before survey</i>	WSTAT1Y=1
			1	Self-employed with employees	
			2	Self-employed without employees	
			3	Employee	
			4	Family-worker	
			9	Not applicable (WSTAT1Y≠1)	
			blank	No answer	

⁴ Or subdivisions of ISCED 1997 – field of education – coded on 3 digits

Labour Force Survey - United Kingdom

NACE1Y2D	148/149	YEARLY		<i>Economic activity of local unit in which person was working one year before survey</i> NACE Rev. 2 00 Not applicable (WSTAT1Y≠1) blank No answer	WSTAT1Y=1
COUNTRY1Y	150/151	YEARLY		<i>Country of residence one year before survey</i> For coding, see ISO country classification 99 Not applicable (child less than one year old) blank No answer	Everybody aged 1 year or more
REGION1Y	152/153	YEARLY		<i>Region of residence one year before survey</i> NUTS 2 99 Not applicable (person who has changed country of residence or child less than one year old) blank No answer	Everybody aged 1 year or more
INCDECIL	154/155	YEARLY		INCOME Monthly (take home) pay from main job 01-10 Deciles order 99 Not applicable (STAPRO ≠ 3) Blank No answer	STAPRO=3
REFYEAR	156/159	QUARTERLY		<i>Year of survey</i> Last 4 digits of the year	everybody
REFWEEK	160/161	QUARTERLY		<i>Reference week</i> Number of the week running from Monday to Sunday	everybody
INTWEEK	162/163	QUARTERLY		<i>Interview week</i> Number of the week running from Monday to Sunday	everybody
COUNTRY	164/165	QUARTERLY		<i>Country</i> For coding, see ISO country classification (Annex IV)	everybody
REGION	166/167	QUARTERLY		<i>Region of household</i> NUTS 2	everybody
DEGURBA	168	QUARTERLY		<i>Degree of urbanisation</i> 1 Densely-populated area 2 Intermediate area 3 Thinly-populated area	everybody
HHNUM	169/174	QUARTERLY		<i>Serial number of household</i> Serial numbers are allocated by the national statistical institutes and remain the same for all waves. Records relating to different members of the same household carry the same serial number	everybody
HHTYPE	175	QUARTERLY		<i>Type of household</i> 1 Person living in private household (or permanently in a hotel) and surveyed in this household 2 Person living in an institution and surveyed in this institution 3 Person living in an institution but surveyed in this private household 4 Person living in another private household on the territory of the country but surveyed in this household of origin	everybody
HHINST	176	QUARTERLY		<i>Type of institution</i> 1 Educational institution	HHTYPE =2,3

Labour Force Survey - United Kingdom

			2	Hospital	
			3	Other welfare institution	
			4	Religious institution (not already included in 1-3)	
			5	Workers' hostel, working quarters at building sites, student hostel, university accommodation, etc.	
			6	Military establishment	
			7	Other (e.g. prison)	
			9	Not applicable (HHTYPE =1,4)	
			blank	No answer	
COEFFY	177/182	YEARLY		<i>Yearly weighting factor</i>	everybody
			0000-9999	Cols 177-180 contain whole numbers	
			00-99	Cols 181-182 contain decimal places	
COEFFQ	183/188	QUARTERLY		<i>Quarterly weighting factor</i>	everybody
			0000-9999	Cols 183-186 contain whole numbers	
			00-99	Cols 187-188 contain decimal places	
COEFFH	189/194	YEARLY		<i>Yearly weighting factor of the sample for household characteristics (in the case of a sample of individuals)</i>	
			0000-9999	Cols 189-192 contain whole numbers	
			00-99	Cols 193-194 contain decimal places	
INTWAVE	195	QUARTERLY		<i>Sequence number of the survey wave</i>	everybody
			1-8	Sequence number of the wave	
INTQUEST	196	QUARTERLY		<i>Questionnaire used</i>	everybody
			1	Only core variables	
			2	Whole questionnaire	
REG3DW (optional)	260/262	QUARTERLY		Region of place of work (NUTS-3)	
REG3D1Y (optional)	263/265	YEARLY		Region of residence one year before the survey (NUTS-3)	
REG3D (optional)	266/268	QUARTERLY		Region of household (NUTS-3)	

Labour Force Survey - United Kingdom

Supplement to the 2009 Codification effective 2011.

ISCO4D	32/35	QUARTERLY		<i>Occupation</i> ISCO-08 (COM) coded at 3 or if possible 4 digit level Not applicable (WSTATOR=3-5,9)	WSTATOR=1,2
			9999	No answer	
			blank	No answer	
ISCOPE3D	96/98	QUARTERLY if having worked in the last 12 months, YEARLY otherwise	999	ISCO-08 (COM) Not applicable (EXISTPR=0,9,blank, or EXISTPR=1 and did not work in last 8 years)	EXISTPR=1 and REFYEAR - YEARPR<8

Supplement to the 2009 Codification effective 2014.

EDUCLEVEL	124 209	QUARTERLY		<i>Level of this education or training</i>	EDUCSTAT = 1 or 3
			1	ISCED 1	
			2	ISCED 2	
			3	ISCED 3	
			4	ISCED 4	
			5	ISCED 5	
			6	ISCED 6	
			7	ISCED 7	
			8	ISCED 8	
			9	Not applicable (EDUCSTAT ≠ 1 or 3)	
			Blank	No answer	
EDUCFILD (optional)	125/127	YEARLY		From 2014 this variable is no longer collected	
EDUCVOC	210	QUARTERLY		<i>Orientation of the educational programme in which the person is enrolled</i>	EDUCLEVEL = 3 or 4
			1	General	
			2	Vocational	
			9	Not applicable (EDUCLEVEL ≠ 3 to 4)	
			Blank	No answer	
HATLEVEL	137/138 197/199	QUARTERLY		<i>Educational attainment level – highest level of education successfully completed</i>	everybody aged 15 years or more
			000	No formal education or below ISCED 1	
			100	ISCED 1	
			200	ISCED 2 (incl. ISCED 3 programmes duration < 2 years)	
			302	ISCED 3 programme duration ≥ 2 years, sequential (i.e. giving access to next ISCED 3 programme only) – partial completion of ISCED 3	
			303	ISCED 3 programme duration ≥ 2 years, terminal or giving access to ISCED 4 only	
			304	ISCED 3 with access to ISCED 5, 6 or 7 (to tertiary education)	
			300	ISCED 3 programme duration ≥ 2 years, without possible distinction of access to other ISCED levels	
			400	ISCED 4	

Labour Force Survey - United Kingdom

			500	ISCED 5	
			600	ISCED 6	
			700	ISCED 7	
			800	ISCED 8	
			999	Not applicable (child < 15 years)	
			Blank	No answer	
HATYEAR	142/145 200/203	QUARTERLY		<i>Year when highest level of education was successfully completed</i>	everybody aged 15 years or more, HATLEVEL 100 to 800
			yyyy		
			9999	Not applicable (HATLEVEL ≠ 100 to 800)	
			Blank	No answer	
HATVOC	204	QUARTERLY		<i>Orientation of the programme completed at the highest education level (referred to in HATLEVEL).</i>	HATLEVEL = 300 to 400 and (15 ≤ AGE ≤ 34 or (AGE > 34 and REFYEAR – HATYEAR ≤ 15))
			1	General	
			2	Vocational	
			9	Not applicable (HATLEVEL ≠ 300 to 400 or (AGE > 34 and REFYEAR – HATYEAR > 15))	
			Blank	No answer	
HATFIELD	139/141 205/208	YEARLY		<i>Field of the programme completed at the highest education level (referred to in HATLEVEL)</i>	HATLEVEL = 300 to 800 and (15 ≤ AGE ≤ 34 or (AGE > 34 and REFYEAR – HATYEAR ≤ 15))
			0000	General programmes	
			0100	Teacher training and education sciences	
			0200	Humanities, languages and arts	
			0222	Foreign languages	
			0300	Social sciences, business and law	
			0400	Science, mathematics and computing	
			0420	Life science (inc biology and environmental science)	
			0440	Physical science (inc physics, chemistry and earth science)	
			0460	Mathematics and statistics	
			0481	Computer science	
			0482	Computer use	
			0500	Engineering, manufacturing and construction	
			0600	Agriculture and veterinary	
			0700	Health and welfare	
			0800	Services	
			0900	Unknown	
			9999	Not applicable (HATLEVEL ≠ 300 to 800 or (AGE > 34 and REFYEAR – HATYEAR > 15))	
			Blank	No answer	

Section 7:

EXPLANATORY NOTES TO THE LFS LIST OF VARIABLES

Demographic background

Col 1/2: (HHSEQNUM) Sequence number within household

A two-digit sequence number should be allocated to each member of the household. It should remain the same for all waves. Persons re-entering the household should retain the original sequence number.

Col 3: (HHLINK) Relationship to reference person in the household

Code 1: Each private household should contain one and only one person coded as 'reference person', who must be a person aged 15 and over.

Code 2 should reflect the “de facto” situation in terms of co-habitation arrangements. It therefore does not necessarily correspond with the “de jure” situation of the household in terms of co-habitation arrangements, as recorded in Col 16 (*Marital status*).

Code 3 should not include sons and daughters in law, who should be coded 5.

Code 4 means the father or the mother of the reference person or of his/her cohabiting partner.

Col 4/5: (HHSPOU) Sequence number of spouse or cohabiting partner

The identification should be done using the sequence number which was allocated to these persons in Col 1/2 (*Sequence number in the household*).

It should reflect the “de facto” situation in terms of co-habitation arrangements. It therefore does not necessarily correspond with the “de jure” situation of the household in terms of co-habitation arrangements, as recorded in Col. 16 (*Marital status*).

Col 6/7: (HHFATH) Sequence number of father

The identification should be done using the sequence number which was allocated to these persons in Col 1/2 (*Sequence number in the household*).

No distinction should be made between biological and non-biological children in the case of adopted children or step children. Father and mother in law should be coded 99.

In case of homoparentality (parents of the same sex) the sequence number of the parents should appear in Col 6/7 and Col 8/9.

Col 8/9: (HHMOTH) Sequence number of mother

The identification should be done using the sequence number which was allocated to these persons in Col 1/2 (*Sequence number in the household*).

No distinction should be made between biological and non-biological children in the case of adopted children or step children. Father and mother in law should be coded 99.

In case of homoparentality (parents of the same sex) the sequence number of the parents should appear in Col 6/7 and Col 8/9.

Col 11/14: (YEARBIR) Year of birth

In case the respondent does not know the exact date of birth (e.g. in case of a proxy) or refuses to answer this question, an estimate should be provided.

Col 15: (DATEBIR) Date of birth in relation to the end of reference period

For persons born in the same year, those coded 1 (birthday falling between 1 January and the end of the reference week) will be, for the purpose of analysing survey results, effectively one year older than those persons coded 2 (birthday falling after the end of the reference week). This definition of age should be applied in all filters that use age.

Col 16: (MARSTAT) Marital status

Marital status is the conjugal status of each individual in relation to the marriage laws of the country (i.e. de jure status). It therefore does not necessarily correspond with the actual situation of the household in terms of co-habitation arrangements, as recorded in Col 3.

In case of borderline situations, e.g., trial separations, or registered cohabitation bestowing some but not full marital rights or duties, the prevailing national statistical convention should apply.

Some countries have a legal framework for registering partnerships (in most countries these are same-sex partnership and they have a legal status parallel to married couples). Such information has also to be treated in a harmonised way so they should be treated as married and classified under group 2 when the partnership still exists, else as 3-4 as appropriate (legal separation or death of one of the partners).

In some countries, children under a certain age cannot have a legal marital status different from "single". To ask them this question would not be necessary, nevertheless they should be coded 1.

Col 17/18: (NATIONAL) Nationality

See country classification in Annex IV (derived from ISO)

Nationality should be interpreted as citizenship. Citizenship is defined as the particular legal bond between an individual and his/her State acquired by birth or naturalisation, whether by declaration, option, marriage or other means according to national legislation. It corresponds to the country issuing the passport.

The concept of nationality should not be mixed up with any concept of ethnic origin. For persons with dual or multiple citizenships, and who hold the citizenship of the country of residence, that citizenship should be coded.

This should be provided according to the coding given in Annex IV. If possible the exact country should be indicated; where this is not possible, one of the general groupings in bold print should be used. EU and EFTA Member States but also candidate and other European countries must be coded individually.

In case of multiple citizenship, including one citizenship of a member state of the European Union, that citizenship should be coded. In other situations the first answer of the respondent should be coded.

This should be provided according to the coding given in Annex IV. If possible the exact country should be indicated; where this is not possible, one of the general

groupings in bold print should be used. EU and EFTA Member States but also candidate and other European countries must be coded individually.

Col 19/20: (YEARESID) Years of residence in this country for persons not born in the country

The years of residence should be calculated taking as starting point the year in which the person last established his or her usual residence in the country (or, in other words, when the person last moved to the country in order to live there).

In case of an interruption in the period of residence, the starting point should be the end of this interruption only if the length of this interruption was at least one year.

For persons with less than one year's residence in this Member State, 01 should be coded; between one year and less than two years, 02; and so on. Up to 2007, people with 10 years of residence and more were coded 11. This is no longer the case from 2008 onwards.

Col 21/22: (COUNTRYB) Country of birth

In case of doubt, the country of birth should be defined as the country of residence of the mother at the time of birth. This definition could help to identify cases where the person was born abroad in exceptional circumstances.

For the purpose of this question, current national boundaries should be considered, rather than any applying at the time of the respondent's birth.

This should be provided according to the coding given in Annex IV. If possible the exact country should be indicated; where this is not possible, one of the general groupings in bold print should be used. European States must be coded individually.

Col 23: (PROXY) Nature of participation in the survey

Code 1 includes all cases where the person is responding directly, even with the assistance of a third person (e.g. interpreter).

Labour status

Col 24: (WSTATOR) Labour status during the reference week

Information provided here determines whether a person is considered as being in employment or not, following the guidelines of International Labour Organisation (ILO). Persons in employment are those coded 1 or 2.

Code 1: Did any work for pay or profit during the reference week

"Work" means any work for pay or profit during the reference week, even for as little as one hour. Pay includes cash payments or "payment in kind" (payment in goods or services rather than money), whether payment was received in the week the work was done or not. Also counted as working is anyone who receives wages for on-the-job training which involves the production of goods or services. Self-employed persons with a business, farm or professional practice are also considered to be working if one of the following applies:

- (i) A person works in his own business, professional practice or farm for the purpose of earning a profit, even if the enterprise is failing to make a profit.
- (ii) A person spends time on the operation of a business, professional practice or farm even if no sales were made, no professional services were

rendered, or nothing was actually produced (for example, a farmer who engages in farm maintenance activities; an architect who spends time waiting for clients in his/her office; a fisherman who repairs his boat or nets for future operations; a person who attends a convention or seminar).

(iii) A person considered as self-employed is in the process of setting up a business, farm or professional practice; this includes the buying or installing of equipment, and ordering of supplies in preparation for opening a new business.

Unpaid family workers: Persons working in a family business or on a family farm without pay should be living in the same household as the owner of the business or farm, or in a slightly broader interpretation, in a house located on the same plot of land and with common household interests. Such people frequently receive remuneration in the form of fringe benefits and payments in kind. However, this applies *only* when the business is owned or operated by the individual themselves or by a relative. Thus, unpaid voluntary work done for charity should *not* be included.

The category includes:

- A son or daughter living inside the household and working in the parents' business or on the parents' farm without pay.
- A wife who assists her husband in his business, e.g. a haulage contractor, without receiving any formal pay.

Persons who work on their own agriculture farm should be considered as employed (code 1 if he worked during the reference week, otherwise code 2) only in case at least part of their production is sold, whichever the total amount of the products. What is considered here is the usual destination of the production, and not whether a sale took place in the reference week. A person who worked in agricultural production during the reference week, did not sale anything because harvesting will take place in few weeks or months, should be consider as having worked for pay or profit in the reference week (code 1). Persons who work on their own small agriculture farm, who do not sell their products, and produce only for their own consumption should not be considered as employed (code 5).

Persons who are obliged to perform some work to keep receiving unemployment benefits
In some countries, unemployed (under special circumstances) have to perform some work to keep receiving the unemployment allowances. If they have performed some work during the reference week, they should be coded 1.

Persons who are building a house

If a person is building a house in order to earn a future financial profit (renting or selling it), he should be considered as employed (code 1 if he worked during the reference week, otherwise code 2). Building a house for only a family use is not enough to be considered as employed.

Conscripts performing some work for pay or profit during the reference week should always be coded 4.

Persons in paid employment who were on training during the whole reference week should be coded 1 if one of the three following statements is true:

- the participation of the employee is required by the employer
- the training takes place inside normal working hours
- the training is directly connected to the current job

Code 2: Was not working but had a job or business from which he/she was absent during the reference week

In general, the notion of temporary absence from work refers to situations in which a period of work is interrupted by a period of absence. This implies that persons are generally to be considered as having been temporarily absent from work and therefore employed, if they had already worked at their current activity and were expected to return to their work after the period of absence. Persons without work who had made arrangements to take up paid employment or to engage in some self-employment activity at a date subsequent to the reference period, but who had not yet started work, are not to be considered as temporarily absent from work.

For employees

A job exists if there is a definite and pre-scheduled arrangement between an employer and employee for regular work (that is, every week or every month), whether the work is full-time or part-time. The number of hours of work done each week or each month may vary considerably, but as long as some work is done on a regular and scheduled basis, a job is considered to exist.

In the case of employees, a person absent from work should be considered as employed if there is a formal attachment to the job, for example if at least one of the following criteria is fulfilled:

- the continued receipt of wage or salary, and an assurance of a return to work (or an agreement as to the date of return) following the end of the contingency..
- the elapsed duration of absence from the job which, wherever relevant, may be that duration for which workers can receive compensation benefits without obligation to accept other jobs.

Seasonal workers

During the off-season, seasonal workers cannot be considered as having a formal attachment to their high-season job if they have an assurance to come back to work with the same employer at the beginning of the next season and the employer continues to pay at least 50% of their wage or salary during the off-season. In this case they have to be coded 2 during the off-season. In other cases, they have to be considered as not employed (code 5).

Maternity and paternity leave

Maternity leave is first given to the mother (but may include the leave of the father in the case of a transfer of the entitlements) and corresponds to the compulsory or statutory period of the leave stipulated by national legislation to ensure that mothers before and after childbirth have sufficient rest, or for a period to be specified according to national circumstances.

People on maternity leave should always be coded 2 in Col 24. Paternity leave is also included under this code.

For unpaid family workers

The unpaid family worker can be said to have a job but not be at work if there is a definite commitment by the employer (a related household member) to accept his/her return to work and the total absence do not exceed a period of 3 months. In this point Eurostat diverges from the ILO recommendation. If the period of absence exceeds 3 months they should be coded 5 in Col 24.

For self-employed persons

If self-employed persons are classified as being absent from work, then they are regarded as in employment only if they can be said to have a business, farm or professional practice. This is the case if one or more of the following conditions are met:

- (i) Machinery or equipment of significant value, in which the person has invested money, is used by him or his employees in conducting his business.
- (ii) An office, store, farm or other place of business is maintained.
- (iii) There has been some advertisement of the business or profession by listing the business in the telephone book, displaying a sign, distributing cards or leaflets, etc.

If none of these conditions is met, then the person is regarded as not being in employment and therefore should be coded 5 in Col 24.

Code 3: Was not working because on lay-off.

A person on lay-off is one whose written or unwritten contract of employment, or activity, has been suspended by the employer for a specified or unspecified period at the end of which the person concerned has a recognised right or recognised expectation to recover employment with that employer.

Lay-offs are classified as employed if they have an assurance of return to work within a period of 3 months or receive $\geq 50\%$ of their wage or salary from their employer.

Lay-offs are classified as unemployed if they receive less than 50% of their wage or salary from their employer, don't have assurance of return to work or have an agreed date but this date falls after a period of 3 months and if they are "available to start work in 2 weeks" and have "actively searched for a job in the last 4 weeks".

Otherwise they are considered as inactive.

In case respondents can't say if they receive more or less than 50% of the salary and if they don't have an assurance of return to work within a period of 3 months the code 3 should be used.

Persons without employment during the reference week but who have found a job to start in the future should always be coded 5 in this column.

Col 25/26: (NOWKREAS) Reason for not having worked at all although having a job

Code only one reason. If the respondent gives more than one reason, code the one that explains the greatest number of hours away from work.

Code 01: This includes difficulties such as plant breakdown or materials shortage; see also note below on Code 02. A person in slack work for technical or economic reasons should have a formal attachment to his/her job.

Code 02: This code only applies to persons who were directly involved in a labour dispute. Other persons who did not work because production in the establishment was impeded by a labour dispute outside the establishment (thus causing a shortage in material supplies for example) are coded 01.

Code 03: It refers to all kind of school education or training, inside or outside the workplace.

Code 05: Maternity leave corresponds to the compulsory or statutory period of the leave stipulated by national legislation to ensure that mothers before and after childbirth have sufficient rest, or for a period to be specified according to national circumstances. Paternity leave is also included under this code.

Code 06: Parental leave can be taken either by the mother or the father and is the interruption of work to bring up a child of young age. This code is used only for those persons on statutory parental leave (legal or contractual). Any other leave taken for reasons of child-bearing or rearing is coded 09.

Code 08: This code includes all absences that are related to working time flexibility. Examples are time off as a compensation of overtime, as a compensation of credit hours within a system of working time banking or within the framework of an annualised hours contract (This category is a parallel to code 07 in Column 69/70). Cases of people who work full-time one week, and not at all the following week are included here.

Employment characteristics of main job

Col 27: (STAPRO) Professional status

The professional status requested here refers to the main job. For the purposes of Col. 27 to 77, multiple job holders decide for themselves which job is to be considered as the first job. In doubtful cases, the first job should be the one with the greatest number of hours usually worked. Persons having changed jobs during the reference week should regard the job held at the end of the reference week as their main job.

Code 1: Self-employed with employees

If people working in the business, professional practice or farm, are not paid then he/she should be considered as self employed without staff.

Code 2: Self-employed without employees

People who engage members of his/her own family or apprentices without payment should be classified in code 2. In this category one can find farmers working alone or using the assistance of members of family.

A person who looks after one or more children that are not his/her own on a private basis and receiving a payment for this service should be considered as self-employed, except when he/she works for a single employer and receives employment rights from that employer (e.g. holiday pay) he/she should be classified as an employee (code 3).

A freelancer should in general be classified as self-employed. However in situations where freelancer works for a single employer and receives employment rights from that employer (e.g. holiday pay) he should be classified as an employee (code 3).

A person who gives private lessons should be considered as self-employed if he/she is directly paid by his/her students.

Members of producers' co-operatives should be considered as self-employed.

In the case co-operative hired workers and these workers have an employment contract that gives them a basic remuneration (which is not directly dependent upon

the revenue of the co-operative), these workers are identified as employees of the co-operative. Even if the co-operative has employees (e.g. an accountant) the members of the co-operative should be considered as “self-employed without employees” because the co-operative as an institution (and not any of its members) is the employer.

Code 3: Employee

An employee is usually working for an outside employer, but a son or daughter, for example, who is working in a parent’s firm and receives a regular monetary wage is classified here as an employee.

A person looking after children in his/her own home is classified as an employee if he/she is paid to do this by the local authority (or any other public administration) and if he/she doesn’t take any decision affecting the enterprise (e.g. schedules or number of children) but should be classified as self-employed if he/she does it privately (code 2).

Apprentices or trainees receiving remuneration should be considered as employees.

Priests (of any kind of religion) are considered employees

Code 4: Family worker

Persons working in a family business or on a family farm without pay should be living in the same household as the owner of the business or farm, or in a slightly broader interpretation, in a house located on the same plot of land and with common household interests. Such people frequently receive remuneration in the form of fringe benefits and payments in kind. However, this applies *only* when the business is owned or operated by the individual themselves or by a relative. Thus, unpaid voluntary work done for charity should *not* be included.

The category includes:

- A son or daughter living inside the household and working in the parents' business or on the parents' farm without pay.
- A wife who assists her husband in his business, e.g. a haulage contractor, without receiving any formal pay.

The category does not include:

- A relative living elsewhere but coming to help with the business, e.g. during the harvesting season, without pay in money or kind should not be included. If the relative receives any remuneration (including benefits in kind) the professional status should be coded as 3 (Employee).

Col 28: (SIGNISAL) Continuous receipt of the wage or salary

The total duration of the absence should be calculated. If the person does not know the total duration, it should be calculated as the elapsed time between the moment the person last worked and the end of the reference week.

The salary to be considered in this variable is the current salary from the main job and net salary should be preferred unless gross salary is easier to collect. Salary can be paid by the employer or by the social security (or both). It includes any compensation of wages (e.g. parental leave allowance linked to the job) but excludes any other benefit which the person would receive even without a job (e.g. family allowances).

The main target groups for this variable are the persons in long term absences:

- the parental leave

- the paid or unpaid leave initiated by the employer or the administration
- the educational or training leave
- other kinds of career breaks

Col 29/31: (NACE3D) Economic activity of the local unit

The local unit is an enterprise or part thereof (e.g. a workshop, factory, warehouse, office, mine or depot) situated in a geographically identified place. At or from this place economic activity is carried out for which one or more persons work (even if only part-time) for one and the same enterprise.

The NACE codes in Annex II are derived from the Statistical Classification of Economic Activities.

If a person works in more than one place (transport, construction, maintenance, surveillance, peripatetic work...) or at home, or in the consumer's place (e.g. surveillance, security, cleaning ...), the local unit is taken to be the place from where instructions emanate or from where the work is organised.

The economic activity of the local unit for persons with a contract with a temporary employment agency should be coded as the activity of the local unit where they actually work and not in the industry of the agency which employs them.

For those countries that are not able to provide information at a 3 digit level the third digit should be coded '0'.

Col 32/35: (ISCO4D) Occupation

This should be coded according to the classification provided in Annex III.

For those countries that are not able to provide information at a 4 digit level the fourth digit should be coded '0'.

Col 36: (SUPERVISOR) Supervisory responsibilities

A person is considered to have supervisory responsibilities when they supervise the work of at least one (other) person. He/she takes charge of the work of other employees, directs their work and sees that is satisfactorily carried out.

Supervisory responsibility includes formal responsibility for directing other employees (other than apprentices), whom they supervise directly, sometimes doing some of the work they supervise and excludes quality control (check output of services but not the work produced by other persons) and consultancy.

It should be considered the usual situation and not the situation only during the reference week.

Sometimes job titles can be misleading. For example, a 'playground supervisor' supervises children not employees and so should be coded 2. Similarly, a 'store manager' may be a storekeeper and not a supervisor of employees.

In some cases the person is cumulating supervising responsibilities with other functions; even if the supervising responsibilities only constitute a part of their job, they should be coded 1.

Persons having supervisory responsibilities only because they are temporarily replacing an absent superior should not be considered as having supervisory responsibilities. The definition of temporarily here is left to the respondent.

Members of groups with Collective responsibility (groups where there is a rotating leadership in a continuous way taking charge of the work of other employees, directing their work and seeing that is satisfactorily carried out) should be considered as having supervisory responsibilities.

Col 37/38: (SIZEFIRM) Number of persons working at the local unit

The number of persons working at the local unit is defined as the total number of persons who work inside the unit (inclusive of working proprietors, partners working regularly in the unit and unpaid family workers), as well as persons who work outside the unit who belong to it and are paid by it (e.g. sales representatives, delivery personnel, repair and maintenance teams). It includes persons absent for a short period (e.g. sick leave, paid leave or special leave), and also those on strike, but not those absent for an infinite period. It also includes part-time workers who are regarded as such under the laws of the country concerned and who are on the payroll, as well as seasonal workers, apprentices and home workers on the payroll (definition of the regulation on Structural Business Surveys).

For the term "local unit", see notes to Col 29/31 (*Economic activity of the local unit*). The codes provided permit either an exact number to be indicated for units with 10 people or less (codes 01-10), broad classes for units with more than 10 (codes 11-13), or simply an indication of whether it is greater or less than ten (codes 14 and 15).

This variable should reflect the current situation but including people temporarily absent. The interviewed person should be included as well.

The number of persons employed should exclude manpower supplied to the unit by other enterprises, persons carrying out repair and maintenance work in the enquiry unit on behalf of other enterprises, as well as those on compulsory military service.

For pragmatic reasons, persons working for a temporary employment agency should provide the numbers of persons working in the local unit where they perform their work.

Codes 14 and 15 should only be used in case 1-13 cannot be coded.

Col 39/40: (COUNTRYW) Country of place of work

This should be provided according to the coding shown in Annex IV. If possible the exact country should be indicated; where this is not possible, one of the general groupings in bold print should be used. Member States must be coded individually.

If you have varied places of work, the country of work is the one where the local unit is settled.

Person working in embassies should be coded as working in the host country.

Col 41/42: (REGIONW) Region of place of work

This should be provided according to the coding system in Annex I, which is based upon the Classification of Territorial Units (NUTS).

Col 43/46 & Col 47/48: (YSTARTWK & MSTARTWK) Year/Month in which person started working for this employer or as self-employed in their current occupation

Renewed contracts

If a respondent has a contract that is renewed, for example yearly, without interruption, the year and the month should be those of the first contract. If there is a legal obligation that an interruption for a certain period of time is necessary before the renewal, this should nonetheless be considered as renewal (and not as a separate spell).

Separate spells of employment

For employees, we are interested in continuous employment with their current employer. Any previous separate spells of work with their current employer with an interruption of the contract should be ignored. The year which the person started the most recent spell should be coded (e.g. seasonal workers).

Company changed ownership

If the respondent's company or firm changed ownership, but his or her conditions of employment did not change, it should be treated as one continuous period of employment. However, if the respondent was made redundant and then re-employed by the new owners, enter the date on which they were re-employed.

Employment agencies

People employed by employment agencies should answer when they started working continuously for this employment agency (despite the fact that in the case of temporary workers the branch of economic activity and the staff category should be based on the current local unit).

Secondment

An employee who has been seconded to another organisation (public or private) should be treated as having no break in employment, IF they have signed a contract that is exactly the same as their existing contract.

Self-employment

For the self-employed make it clear that we are interested in the length of time the respondent has been continuously self employed in the occupation of his current main job.

Col 49: (WAYJFOUN) Involvement of the public employment office at any moment in finding the present job

The involvement of the public employment office should be effective, i.e. having contributed to the finding of the current job. It should be a role of putting in contact the employer and the employee by informing one of the existence of the other. "Putting in contact" should be interpreted broadly, and could simply involve the respondent seeing a job vacancy on the website of the employment office.

Jobs found through the home page of the public employment office have also to be coded as 1.

When the action of public employment office is only to send the person to training courses or any other activities that improve the skills of job searchers and which had allowed the person to take this job, without putting the person in contact with his current employer, then the code 0 applies.

Col 50: (FTPT) Full-time/Part-time distinction

This variable refers to the main job. A part-time worker is “an employed person whose normal hours of work are less than those of comparable full-time workers” (International Labour Conference, 81st session, 1994).

The distinction between full-time and part-time work should be made on the basis of a spontaneous answer given by the respondent. It is impossible to establish a more exact distinction between part-time and full-time work, due to variations in working hours between Member States and also between branches of industry.

Col 51: (FTPTREAS) Reasons for part-time work

The current main reason for working part-time should be coded.

Code 3: Care includes all care responsibilities:

- For own children or spouse children living inside or outside the household
- For other children (up to 14) living inside or outside the household
- For adult ill/elderly/incapacitated/disabled relatives/friends (aged 15 or more)

But excludes:

- Care as a job (it means that care done in a professional capacity is excluded).
- Care as a volunteer work (e.g. for a charity organisation)

In both cases, they should be coded as 6.

Col 52: (TEMP) Permanency of the job

Employees with a limited duration job/contract (code 2) are employees whose main job will terminate either after a period fixed in advance, or after a period not known in advance, but nevertheless defined by objective criteria, such as the completion of an assignment or the period of absence of an employee temporarily replaced.

Code 2 includes:

- Persons with a seasonal job
- persons engaged by a temporary employment agency or business and hired out to a third party for the carrying out of a "work mission" (unless there is a work contract of unlimited duration with the employment agency or business)
- Persons with specific training contracts.

What is involved is the actual employment being time-limited under an agreement - not that he/she has, for example, considered stopping work in order to travel or attend College.

Respondents who have a contract to do their job, which is expected to be renewed, for example, once a year, should be coded according to whether or not the respondents themselves consider their job to be of an unlimited duration.

A person having a contract for a probationary period should be coded 2 (see definition of probationary period in the explanatory note of col 53 (*Reasons for having a temporary job/work contract of limited duration*)).

In case of secondment from a permanent job, the person should be considered as having a contract of unlimited duration, if the person has an assurance to go back to his previous job.

Col 53: (TEMPREAS) Reasons for having a temporary job/work contract of limited duration
The probationary period is part of a selection process during which an employee new to a job is required to demonstrate fitness for the job by actual performance of the job's duties.

In the case where more than one category applies temporary work in relationship with a period of training or trial period (Col. 53= 1 or 4) are priority reasons for a temporary job.

The current reason of having a temporary job should be coded, even if it differs from the starting reason.

Col 54: (TEMPDUR) Total duration of temporary job or work contract of limited duration
This refers to the total of the time already elapsed plus the time remaining until the end of the current contract.

Code 2 should be interpreted as 1 month to less than 4 months, code 3 as 4 to less than 7 months and so on.

Persons who have a contract to perform a task should be prompted for a best estimate for how long it would take.

Respondents who have a contract to do their job, which is renewed, for example, once a year, should be coded referring to the current contract.

Col 55: (TEMPAGCY) Contract with a temporary employment agency
A temporary employment agency is a firm which places workers with whom it has entered contracts of employment at the temporary disposal of user firms.

Work for a temporary employment agency involves a triangular employment relationship between an employee who is paid by the employment agency but performs work for and under the supervision of a user enterprise.

Staff leasing is excluded here; staff leasing applies in the case when the type of expert knowledge or experience needed by the user enterprise is matched by the economic activity of the service provider. The service provider has not a general intermediary function on the labour market.

Staff working directly for the temporary employment agency (administrative tasks), i.e. not employed to perform any work for and under the supervision of a user enterprise, should be coded 0.

Persons employed by an agency to perform work for and under the supervision of a user enterprise, but not performing any work during the reference week for and under the supervision of a user enterprise and who are asked to perform administrative or other tasks for the agency should anyway be coded as working for a temporary employment agency because this situation do not correspond to their usual situation.

If a country has this information from other sources this variable can be imputed and the information does not have to be collected by interview.

The "Economic activity of the local unit" (NACE3D) for persons with a contract with a temporary employment agency should be coded as the activity of the enterprise where they actually work and not in the industry of the agency which employs them.

Atypical work

Col 56: (SHIFTWK) Shift work

"Shift work" means any method of organising work in shifts whereby workers succeed each other at the same work stations according to a certain pattern, including a rotating pattern, and which may be continuous or discontinuous, entailing the need for workers to work at different times over a given period of days or weeks (definition of the directive 2003/88/EC).

Shift work usually involves work on unsocial hours in the early morning, at night or in the weekend and the weekly rest days do not always coincide with the normal rest days.

Shift work should imply changes in the working schedule. Persons having fixed assignment to a given shift should not be considered as shift-workers, even if their working schedules are defined in their establishment in terms of shift work.

Col 57: (EVENWK) Evening work

The definitions of evening and night vary considerably so that it is not easy to establish a strictly common basis for all Member States. Generally speaking, however, "evening work" must be considered to be work done after the usual hours of working time in this Member State, but before the usual sleeping hours. This implies the possibility of sleeping at normal times (whereas "night work" implies an abnormal sleeping pattern).

Code 1: "Usually" in this context should be interpreted to mean:

- for self-employed, working during the evenings at least half of the days worked in a reference period of four weeks preceding the end of the reference week.
- for employees, having a formal working time arrangement to work in the evenings and working during the evenings at least half of the days worked in a reference period of four weeks preceding the end of the reference week.

Code 2: "Sometimes" in this context should be interpreted to mean:

- for self-employed, working during the evenings less than half of the days worked, but at least in one occasion in a reference period of four weeks preceding the end of the reference week.
- for employees, having a formal working time arrangement to work in the evenings and working during the evenings less than half of the days worked in a reference period of four weeks preceding the end of the reference week.

Code 3: "Never" in this context should be interpreted to mean:

- for self-employed, working during the evenings on no occasion in a reference period of four weeks preceding the end of reference week.
- for employees, having no formal working arrangement to work in the evening.

Col 58: (NIGHTWK) Night work

Bearing in mind the definitional problems discussed under Col 57 (Evening work), "night work" must be generally considered to be work done during the usual sleeping hours. This implies an abnormal sleeping pattern (whereas "evening work" implies the possibility of sleeping at normal times). As foreseen by directive 2003/88/EC, the definition of usual sleeping hours can vary by country but, in any case, it should include hours between midnight and 5 a.m.

Code 1: "Usually" in this context should be interpreted to mean:

- for self-employed, working during the nights at least half of the days worked in a reference period of four weeks preceding the end of the reference week.
- for employees, having a formal working time arrangement to work in the nights and working during the nights at least half of the days worked in a reference period of four weeks preceding the end of the reference week.

Code 2: "Sometimes" in this context should be interpreted to mean:

- for self-employed, working during the nights less than half of the days worked, but at least in one occasion in a reference period of four weeks preceding the end of the reference week.
- for employees, having a formal working time arrangement to work in the nights and working during the nights less than half of the days worked in a reference period of four weeks preceding the end of the reference week.

Code 3: "Never" in this context should be interpreted to mean:

- for self-employed, working during the nights on no occasion in a reference period of four weeks preceding the end of reference week.
- for employees, having no formal working arrangement to work in the nights.

Col 59: (SATWK) Saturday work

Code 1: "Usually" in this context should be interpreted to mean:

- for self-employed, working on Saturdays at least half of the days worked in a reference period of four weeks preceding the end of the reference week.
- for employees, having a formal working time arrangement to work on Saturdays and working during on Saturdays at least half of the days worked in a reference period of four weeks preceding the end of the reference week.

Code 2: "Sometimes" in this context should be interpreted to mean:

- for self-employed, working on Saturdays less than half of the days worked, but at least in one occasion in a reference period of four weeks preceding the end of the reference week.
- for employees, having a formal working time arrangement to work on Saturdays and working during on Saturdays less than half of the days worked in a reference period of four weeks preceding the end of the reference week.

Code 3: "Never" in this context should be interpreted to mean:

- for self-employed, working on Saturdays on no occasion in a reference period of four weeks preceding the end of reference week.
- for employees, having no formal working arrangement to work on Saturdays.

Col 60: (SUNWK) Sunday work

Code 1: "Usually" in this context should be interpreted to mean:

- for self-employed, working on Sundays at least half of the days worked in a reference period of four weeks preceding the end of the reference week.
- for employees, having a formal working time arrangement to work on Sundays and working during on Sundays at least half of the days worked in a reference period of four weeks preceding the end of the reference week.

Code 2: "Sometimes" in this context should be interpreted to mean:

- for self-employed, working on Sundays less than half of the days worked, but at least in one occasion in a reference period of four weeks preceding the end of the reference week.
- for employees, having a formal working time arrangement to work on Sundays and working during on Sundays less than half of the days worked in a reference period of four weeks preceding the end of the reference week.

Code 3: "Never" in this context should be interpreted to mean:

- for self-employed, working on Sundays on no occasion in a reference period of four weeks preceding the end of reference week.
- for employees, having no formal working arrangement to work on Sundays.

Hours worked

Col 61/62: (HWUSUAL) Number of hours per week usually worked in the main job

Usual hours worked are the modal value of the actual hours worked per week (see definition of Col 63/64) over a long reference period, excluding weeks when an absence from work occurs (e.g. holidays, leaves, strikes ...). For employees covered by an employment contract, it should include contractual hours of work plus overtime that the employee is expected to work regularly according to his or her contract.

The "long reference period" mentioned here is at least the last four weeks and at most the three last months without counting any absence from work. When such a long reference period cannot be identified (because the working hours vary too much, or the person has just started a new job), a proxy can be accepted:

- the contractual hours of work in the reference week, for those who have an employment contract, plus regular overtime if the worker is expected to work overtime
- an average of the actual hours worked in the last four weeks, plus the hours of absence of work in the last four weeks.

The implementation rules mentioned for Col 63/64 about main meal breaks, on-call time, travelling time, training time, working at home, teachers and farmers also apply for HWUSUAL.

People absent for a long period:

For people in employment who last worked before the long reference period of at least four weeks, the usual hours worked should refer to the situation immediately before the start of the extended absence from work. Thus the usual hours of work of persons on maternity leave refer to the usual hours as they would have been identified had the person been asked in the week before starting the maternity leave.

For people who have different working time arrangement depending on seasons, the usual hours worked should refer to the current season.

Col 63/64: (HWACTUAL) Number of hours actually worked during the reference week (main job)

Actual hours worked in the reference week are the hours the person spends in work activities during the reference week.

Work activities should include:

- production activities: activities when directly engaged in the production of goods or services as defined in the European System of Accounts.
- ancillary activities: activities not directly intended for the production of goods or services but which are necessary to enable such production (such as travel between places of work, personnel management)
- short pauses: interruptions in the production or ancillary activities that are the necessary consequence of the organisation of the work activities or the use of labour, such as short rest periods (incl. coffee breaks)
- education and training which is necessary for successfully carrying out of either the production or ancillary activities.

Actual hours worked should exclude:

- travel time between home and the place of work
- the main meal breaks
- education and training hours which are not directly necessary for carrying out the production or ancillary activities
- absences from work within the working period for personal reasons (such as visits to the doctor).

Actual hours worked should include time spent at the place of work such as preparing the site, repair and maintenance work, the preparation and cleaning of the tools, and the making-out of receipts, invoices, records of the length of time worked and other reports.

Working hours not paid by the employer (including unpaid overtime)

For employees, the hours have not to be explicitly required by the employer, but it has to be hours spent in activities related to the job that the employee is paid for. The hours spent in such activities but not recognised by the employer should be included in actual hours worked.

On-call time

The directive 2003/88/EC defines on-call time as the “period during which the worker has the obligation to be available at the workplace in order to intervene, at the employer's request, to carry out his activity or duties”⁵.

The workplace is defined as “the place or places where the worker normally carries out his activities or duties and which is determined in accordance with the terms laid down in the relationship or employment contract applicable to the worker”.

The inactive part of on-call time is the “period during which the worker is on-call, but not required by his employer to carry out his activity or duties”.

The active part of on-call time should be obviously included in the working hours.

The idle part at the workplace (e.g. sleeping hours in a hospital for a doctor) should be included in the working hours, as the worker must be in a state of readiness.

⁵ Remark: There are two definitions of “on-call” The working time directive essentially refers to what is called “stand-by” in the US. In the 2001 and 2004 ahm on working time arrangements “on-call” was defined differently as a contractual arrangement when the worker only works when called without the obligation either to perform the duty or for the employer to guarantee the work. In UK English this would be called zero-hours arrangement (example: babysitters).

The inactivity outside the normal workplace is not work activity unless the burden or the restrictions placed on the worker are too high, such requirement to wear uniforms, to stay in a special accommodations outside the workers home.

Training time inside/outside the workplace

For employees, training time should be included if one of the following statements is true:

- the participation of the employee is required by the employer
- the training takes place inside normal working hours
- the training is directly connected to the current job

Treatment of travelling time for business trips

For purely business trips, related to the current job, travelling time has to be considered as time spent in ancillary activities, and then to be included in actual hours worked.

Working at home

The time spent at home in working activities directly related to the current job has to be taken into account in the actual working hours (and also in the usual, if they occur regularly).

Teachers

Usually the teachers' employment contract refers to weekly hours spent in the classroom. However, all actual hours worked directly related to teaching have to be considered. It particularly includes teaching in or out the class, preparation and planning the course, marking, attending meetings and conferences related to teaching. Supervision of school trips where attendance is required should be included (sleeping hours during school trips should be excluded).

Farmers

Hours spent in running the farm, preparing the production for selling, supervising employees, as well as hours spent in commercial and administrative tasks linked to the farm should be counted here.

Hours spent in production only designated to own consumption, and hours spent in the farm without doing anything connected to the agricultural business should be excluded.

Col 65/66: (HWOVERP) Paid overtime in the reference week in the main job

Overtime hours are the number of hours actually worked by an employee in excess of his or her contractual hours of work.

Contractual hours of work are the hours the employee is expected to work in the reference week as predetermined (by order of preference) by convention at the enterprise level, by collective agreement or by the legislation.

Paid overtime hours are the number of hours actually worked by an employee in excess of his or her contractual or normal daily or weekly hours of work for which the employee is entitled to compensation, in pay, kind or compensatory leave.

When the person does not know his contractual hours the benchmark should be the general number of hours foreseen by the legislation for full-time workers.

Contractual hours used as benchmark to calculate the overtime hours (contractual or normal hours) should exclude the hours of absence from work during the reference week (free days, leaves, holidays, ...).

Flexitime arrangement is an agreement between the employer and the employee that requires an employee to be at work during a specified core period, but lets them otherwise arrange their hours to suit themselves. During a specific period (a fortnight, a month, a year), the employer and the employee agree on a given number of hours, but the pattern of work can vary from week to week. In this case, only hours outside the flexitime arrangement should be overtime hours. If these working hours are paid as overtime hours, then they should be included here.

Working time banking: extra working hours (hours in addition to contractual hours of work) performed in the reference week, and recuperated later (additional leave or period of rest after the reference week) should be included in overtime hours in the reference week. As there are entitled to compensatory leave, then they should be considered as paid overtime. Daily overtime compensated by time off during the reference week should be excluded here.

For teachers, paid overtime is time spent in paid courses in excess of their regular contract.

Col 67/68: (HWOVERPU) Unpaid overtime in the reference week in the main job

Unpaid overtime hours are the number of hours actually worked by an employee in excess of his or her contractual or normal daily or weekly hours of work for which the employee is not entitled to compensation, in pay, kind or compensatory leave.

For employees, the hours have not to be explicitly required by the employer, but it has to be hours spent in activities related to the job that the employee is paid for. The hours spent in such activities but not recognised by the employer should be included in unpaid overtime.

Flexitime arrangement is an agreement between the employer and the employee that requires an employee to be at work during a specified core period, but lets them otherwise arrange their hours to suit themselves. During a specific period (a fortnight, a month, a year), the employer and the employee agree on a given number of hours, but the pattern of work can vary from week to week. In this case, only hours outside the flexitime arrangement should be overtime hours. If these working hours are not paid as overtime hours, then they should be included here.

Working time banking: extra working hours (hours in addition to contractual hours of work) performed in the reference week, and recuperated later (additional leave or period of rest after the reference week) should be considered as paid overtime and excluded for this variable. Daily overtime compensated by time off during the reference week should also be excluded here.

For teachers, unpaid overtime is hours spent in the preparation of the courses done in addition to their regular contract.

Col 69/70: (HOURREAS) Main reasons for hours actually worked during the reference week being different from the person's usual hours

This question should also be asked of those persons who did not state their usual hours (Col 61/62 = 00). They may know if they have worked considerably more or less than usual even if they cannot give a number for their usual hours.

In a case where more than one reason applies, the reason to be coded is that which explains the greatest number of hours. In the case where the same number of hours is

justified by different reasons, the following rule should be applied: if one of these reasons is "overtime" then code 16 should be coded, otherwise the lowest code should be coded.

Code 01: Applies in case of flexitime arrangement.

Code 04: This includes difficulties such as plant breakdown or materials shortage; see also note below on Code 05.

Code 05: This code only applies to persons who were directly involved in a labour dispute. Other persons who did not work because production in the establishment was impeded by a labour dispute (thus causing a shortage in material supplies, for example) are coded 04.

Code 09: Maternity leave is first given to the mother (but may include the leave of the father in the case of a transfer of the entitlements) and corresponds to the compulsory or statutory period of the leave stipulated by national legislation to ensure that mothers before and after childbirth have sufficient rest, or for a period to be specified according to national circumstances. Paternity leave should be included here.

Code 09: Parental leave can be taken either by the mother or the father and is the interruption of work in the case of childbirth or to bring up a child of young age. It should correspond to the statutory period provided by the national legislation. This code is used only for those persons on statutory parental leave (legal or contractual). Any other leave taken for reasons of child-bearing or rearing is coded 10: "special leave for personal or family reasons".

Code 16: Overtime includes paid and unpaid overtime as defined for variables HWOVERP (Col 65/66) and HWOVERPU (Col 67/68).

Col 71: (WISHMORE) Wish to work more hours than the current numbers of hours
Persons in time-related underemployment comprise all persons in employment, as defined in current international guidelines regarding employment statistics, who satisfy the following three criteria during the reference period used to define employment:

- a) "willing to work additional hours", i.e. wanted another job (or jobs) in addition to their current job (or jobs) to increase their total hours of work; to replace any of their current jobs with another job (or jobs) with increased hours of work; to increase the hours of work in any of their current jobs; or a combination of the above. In order to show how "willingness to work additional hours" is expressed in terms of action which is meaningful under national circumstances, those who have actively sought to work additional hours should be distinguished from those who have not. Actively seeking to work additional hours is to be defined according to the criteria used in the definition of job search used for the measurement of the economically active population, also taking into account activities needed to increase the hours of work in the current job;
- b) "available to work additional hours", i.e. are ready, within a specified subsequent period, to work additional hours, given opportunities for additional work. The subsequent period to be specified when determining workers' availability to work

additional hours should be chosen in light of national circumstances and comprise the period generally required for workers to leave one job in order to start another;

- c) "worked less than a threshold relating to working time", i.e. persons whose "hours actually worked" in all jobs during the reference period, as defined in current international guidelines regarding working time statistics, were below a threshold, to be chosen according to national circumstances. This threshold may be determined by e.g. the boundary between full-time and part-time employment, median values, averages, or norms for hours of work as specified in relevant legislation, collective agreements, agreements on working time arrangements or labour practices in countries.

The question should refer to the usual situation in all the jobs. In the same resolution as the definition mentioned above, it is stated that: "To provide analytical flexibility for policy formulation and evaluation, as well as for international comparability, countries should endeavour to identify all workers who during the reference period were willing and available to work additional hours, regardless of the hours they actually worked during the reference period".

Col 72: (WAYMORE) Way that a person can work more

Code 4: This code applies to those persons who would like to work a greater number of hours with none of the restrictions set out in codes 1 to 3.

Col 73/74: (HWWISH) Number of hours that the person would like to work in total

This variable should include the total number of working hours the person would like to work.

Col 75: (HOMEWK) Working at home

This concept applies also to self-employed people, for example in artistic or professional activities, who work wholly or partly at home, often in a part of their living accommodation set aside for the purpose.

However, if the place of work comprises a separate unit (for example, a doctor's surgery or tax consultant's practice) which is adjacent to the person's home but contains a separate entrance, then work performed there should not be considered to be done "at home". Similarly, a farmer is not to be regarded as working "at home" when he is occupied in fields or buildings adjacent to his house.

In the case of employees, "working at home" should be interpreted strictly in terms of formal working arrangements, where it is mutually understood by the employee and the employer that a certain part of the work is to be done at home. Such an arrangement may be explicitly included in the terms of employment, or may be recognised in other ways (for example, if the employee explicitly notifies the employer of this work by completing a timesheet, or by requesting additional payment or other form of compensation). This arrangement is also recognised if an employee is equipped with a computer in his home in order to perform his work.

Other typical examples of "working at home" include travelling salesmen who prepare at home for appointments with clients which are then held at the clients' offices or homes, or persons who do typing or knitting work which on completion is sent to a central location.

"Working at home" does not cover cases where employees carry out tasks at home (because of personal interest or pressure of time), which under their working arrangements might equally have been performed at their place of work.

Code 1: "Usually" in this context should be interpreted to mean that during a reference period of four weeks preceding the interview, the person did work at home within the framework of an agreement as described above, and the number of occasions on which he did so amounted to half or more of the days worked in this period.

Code 2: "Sometimes" in this context should be interpreted to mean that during a reference period of four weeks preceding the interview, the person did work at home within the framework of an agreement as described above, but the number of occasions on which he did so amounted to less than half of the days worked in this period.

Code 3: "Never" in this context should be interpreted to mean that during a reference period of four weeks preceding the interview, the person did not on any occasion work at home within the framework of an agreement as described above.

Col 76: (LOOKOJ) Looking for another job

The reference period of the question should be the four weeks preceding the end of the reference week.

Should be considered as searching for employment (code 1). It includes people who are looking for a different job at the current employer, as well as people who have applied for a permanent position on the same job that they are now performing.

Self-employed people may interpret 'looking for additional job' as trying to increase their present business. Looking for additional clients is not enough to be coded 1 here. Self-employed people should be coded 1 for this question if they were looking for a job as employee or if they were looking for a *different business* in the reference week.

Col 77: (LOOKREAS) Main reason for looking for another job

When more than one reason had been mentioned the order of priority should be 1, 3, 4, 5, 6, 2, and 7, with 1 being the highest priority.

Information about second jobs

Col 78: (EXIST2J) Existence of more than one job or business

The same rules as for main job applies to determine whether the person is employed in his second job or not.

Col 79: (STAPRO2J) Professional status (in the second job)

See notes to Col 27 (Professional Status).

Col 80/81: (NACE2J2D) Economic activity of the local unit (in the second job)

The NACE codes in Annex II are derived from the Statistical Classification of Economic Activities. For the term "local unit" see notes to Col 29/31.

Col 82/83: (HWACTUA2) Number of hours actually worked during the reference week in the second job

See notes to Col 63/64. The number of hours given here corresponds to the number of hours the person actually worked during the reference week in the second job. This

includes all hours including extra hours regardless of whether they were paid or not. Travel time between home and the place of work as well as the main meal breaks (normally taken at midday) are excluded.

Persons who have also worked at home (within the definitions given in the notes to Col 75) are asked to include the number of hours they have worked at home. Apprentices, trainees and other persons in vocational training are asked to exclude the time spent in school or other special training centres.

If the number of hours given by the respondent is not a complete number of hours the number should be rounded (ex: 37.5 hours should be coded 38).

Previous work experience of person not in employment

Col 84: (EXISTPR) Existence of previous employment experience

The previous employment experience should be an employment for pay or profit.

A person who only has in his work experience non-paid traineeships should be coded 0 here.

For people on lay-off (WSTATOR= 3), this question refers to the job that they have been laid-off.

In the case of a student who had been continuously performing PAID work alongside with studies, then that experience should be looked upon as a previous work experience, even if the amount of hours was limited.

Col 85/88: (YEARPR) Year in which person last worked

Although compulsory military or community service is not regarded as employment in the framework of the survey, respondents who, after having left their last job, were conscripts on compulsory military or community service should indicate the month and year in which they completed this service in order that this period is not counted in the unemployment duration.

For people on lay-off, this question refers to the job that they have been laid-off. Purely occasional job or vacation work does not include small jobs that are extended over a longer period of time, such as students working few hours every weekend during the school-year.

Col 89/90: (MONTHPR) Month in which person last worked

Although compulsory military or community service is not regarded as employment in the framework of the survey, respondents who, after having left their last job were conscripts on compulsory military or community service should indicate the month and year in which they completed this service in order that this period is not counted in the unemployment duration.

For people on lay-off, this question refers to the job that they have been laid-off.

Col 91/92: (LEAVREAS) Main reason for leaving last job or business

Due to recall problems this variable is restricted to those who had stopped work within the last 8 years, nevertheless if the person has not answered in which year they have last worked, he/she should answer the present question.

Code 00: Dismissed or made redundant

This code is used for employees whose employment ended involuntarily. It includes those employees who were dismissed, made redundant, or lost their job because their employer either went out of business, or sold or closed down the business.

Code 01: A job of limited duration has ended

This code is used for employees who declare that their last job was temporary and came to an end, or that they had a formal work contract which was completed. This also applies to seasonal and casual jobs.

Code 02: Looking after children or incapacitated adults

Care includes all care responsibilities:

- For own children or spouse children living inside or outside the household
- For other children (up to 14) living inside or outside the household
- For adult ill/elderly/incapacitated/disabled relatives/friends (aged 15 or more)

But excludes:

- Care as a job (it means that care done in a professional capacity is excluded).
- Care as a volunteer work (e.g. for a charity organisation)

In both cases, they should be coded as 09.

Code 03: Other personal or family responsibilities

Other personal or family responsibilities may include marriage, pregnancy, long vacation etc. However, if the respondent left his/her job because of personal health-related reasons then code 04 should be used.

Code 06: Early retirement

This code applies to those employees who have taken the early retirement option due to economic factors (labour market problems, difficulties in specific sectors of the economy, etc.), before the normal retirement age in his activity. If the respondent retired from his/her job at the normal retirement age then code 07 should be used.

Code 09: Other reasons

This code is used where none of the codes 00-08 applies, including cases where the person has resigned from his job for reasons (such as personal dissatisfaction) not covered by any of the other codes. Self-employed persons who went out of business, or sold or closed down the business should also be coded 09. People on lay-off should also belong to this category.

Col 93: (STAPROPR) Professional status in last job

See notes for Col 27. Due to recall problems this variable is restricted to those who had stopped work within the last 8 years, nevertheless if the person has not answered in which year they have last worked, he/she should answer the present question.

For people on lay-off, this question refers to the job that they have been laid-off.

Col 94/95: (NACEPR2D) Economic activity of the local unit in which person last worked

See notes for Col 29/31. The NACE codes in Annex II are derived from the Statistical Classification of Economic Activities. For the term "local unit", see notes to Col 29/31.

Due to recall problems this variable is restricted to those who had stopped work within the last 8 years, nevertheless if the person has not answered in which year they have last worked, he/she should answer the present question.

For people on lay-off (Col 24 = 3), this question refers to the job that they have been laid-off.

Col 96/98: (ISCOPR3D) Occupation of last job

See notes for Col 32/35. This should be coded according to the ISCO-COM classification provided in Annex III.

Due to recall problems this variable is restricted to those who had stopped work within the last 8 years, nevertheless if the person has not answered in which year they have last worked, he/she should answer the present question.

For people on lay-off, this question refers to the job that they have been laid-off.

Search for employment

Col 99: (SEEKWORK) Seeking employment during previous four weeks

The period of reference for this variable is the last four weeks ending with the reference week, in order to remain consistent with the variables concerning the methods used during the previous four weeks.

Due to the importance of this question in defining the unemployed, every effort should be made to ensure that an answer is given to this question. 'Blanks' are not allowed.

Those people not seeking employment are questioned on their willingness to work at Col 116.

Persons coded 2 are considered as 'not searching anymore' since they have already found a job. In case they are still searching for a work, they should be coded as 4.

Code 1 and 2: Person has already found a job to start later

This applies to all persons without a job during the reference week, and who have already found a job which will start later. Persons who were coded 1 in this variable are considered as unemployed when they are available for work in the two weeks after the reference week. Those coded 2 are considered inactive because they were not looking for a job (otherwise they would have been coded 4). The period of 3 months considered follows the week of reference.

Code 4: Person is seeking employment

Also considered as seeking employment is a person who seeks an opportunity of professional training within an enterprise, e.g. as an apprentice or trainee.

Col 100: (SEEKREAS) Reasons for not seeking employment

Code 1: Awaiting recall to work (persons laid-off)

This code is to re-identify those persons who in Col 24 state they are laid-off and not seeking employment.

Code 03: Looking after children or incapacitated adults

Care includes all care responsibilities:

- For own children or spouse children living inside or outside the household
- For other children (up to 14) living inside or outside the household
- For adult ill/elderly/incapacitated/disabled relatives/friends (aged 15 or more)

But excludes:

- Care as a job (it means that care done in a professional capacity is excluded).

- Care as a volunteer work (e.g. for a charity organisation)

In both cases, they should be coded as 8.

Code 7: Belief that no work is available.

This code permits the estimation of the number of "discouraged workers".

Col 101: (SEEKTYPE) Type of employment sought (or found)

Code 1: As self-employed

Persons seeking self-employment, who are without employment during the reference week, are also asked under Col 110-111 whether they have taken any active steps during the past 4 weeks to set up a business, farm or professional practice.

Codes 2/5: Only full-time/part-time job is looked for (or has already been found)

Persons having already found a job as employee which will start later should be coded either 2 or 5 depending on whether the job found is full-time or part-time. Codes 3 and 4 do not apply for this group.

When the person does not know which type of employment he is looking for, it as to be coded 6 unless he took active steps to be self-employed (code 1 in this case).

Col 102: (SEEKDUR) Duration of search for employment

The period of search should be the last continuous period of active search without significant interruption (in this case significant means at least four weeks).

For people who have found a job which will start later the period of search starts at the beginning of the search and ends when the person finds the job.

Methods used during previous weeks to find work

Col 103 to 115: (METHOD (A-M))

The 11th principle for the formulation of the question of the labour status (Commission Regulation 1897/2000) states that: "Questions are enumerated until at least three active methods have been mentioned".

Blanks are not allowed. If a person does not know or refuses to answer this should be coded as 0.

Only the methods used during the four weeks ending with the reference week are to be recorded

Col 103: (METHODODA) Contacted public employment office to find work

"The 'contact with the public employment office to find work' only involves:

- putting the respondent's names in the employment office files for the first time (after a spell of employment or inactivity)
- finding out about possible job vacancies, or
- 'at the initiative of the employment office a suggestion of a job opportunity', which may be accepted or refused by the job searcher."

Contacts through the website of the public employment office with the objective of finding a job should be coded 1 (yes).

Col 107: (METHODODE) Inserted or answered advertisements in newspapers or journals

The insertion or the answer of advertisements from a website (excepted website of public employment service) should be coded 1 here.

Col 108: (METHODF) Studied advertisements in newspapers or journals

The consultation of job advertisements in internet and the consultation of list of job vacancies in the entrance of the factories should be coded as 1 (yes).

Col 115: (METHODM) Other method used

In this Column, the answer "yes" should be recorded only if the person has used an active method not covered by Col 103 to 111. Passive methods not coded before should be coded no.

Use of Internet should not be considered as a separate method, but as a mode of the relevant methods in Col 103 to 111. Browsing the internet to look for available job openings is thus a mode of reading advertisements in journals and newspapers.

Sending an inquiry through a web-side form or e-mail to a public employment office in order to find a job is thus contact with a public employment office for the purpose of finding a job, etc.

Col 116: (WANTWORK) Willingness to work for person not seeking employment

This question is intended to permit a more exact measure for "discouraged workers". It is put to persons coded 3 Col 99, i.e. without employment and not seeking employment. Discouraged workers are persons who are not seeking work because they believe that none is available (Col 100=7) but would nevertheless like to have a job (Col 116=1).

The reference period of this question is the reference week, but it is not necessary to mention it in the questionnaire. The person is asked whether he/she would like to have a paid employment, whatever the number of hours worked.

Col 117: (AVAILBLE) Availability to start working within two weeks

'Immediately available' means that if a job were found at the time of the interview, the person would be able to start work within two weeks.

Testing for availability in the two weeks following the reference week is considered more appropriate than testing during the reference week, because some persons may be unavailable for work during the reference week due to obstacles that might have been overcome had they known that a job was available to them.

Col 118: (AVAIRES) Main reason for not being available to start working within two weeks

The variable is used to set the position of inactive people with respect to the labour market. Ask spontaneous reasons. Main reason should be collected.

Col 119: (PRESEEK) Situation immediately before person started to seek employment

If more than one category applies, the main situation should be coded.

If the person did not search employment because the job was offered, the situation to be coded is the one when the job was offered.

Col 120: (NEEDCARE) Need for care facilities

Care includes all care responsibilities:

- for own children or spouse children living inside or outside the household
- for other children (up to 14) living inside or outside the household
- for adult ill/elderly/incapacitated/disabled relatives/friends (aged 15 or more)

But excludes:

- Care as a job (it means that care done in a professional capacity is excluded).
- Care as a volunteer work (e.g. for a charity organisation)

The need for care services can be a need for normal working hours or for special periods of day (very early in the morning or late evening) or for special periods of the year (e.g. school holidays).

Care services exclude the unpaid help by relatives, friends or neighbours. The care services can be private or subsidised by the State or the employers and consequently paid or not paid.

Some examples of care services could be crèche, day care centre, organised family care (e.g. family crèches, home-based care by childminders affiliated to a child minding service), after school centre, paid carers, specialised centres for persons with disabilities, institutions, assistance at home.

The word “suitable” means the minimum standards of quality that the person requests from a care service. This notion of quality involves schedules, quality of the personnel, specific expertise to care for the particular care needs (e.g. disability) in question, etc.

The word “available” means at a reasonable distance, taking into account also the means of transport and currently open/available for use to the respondent.

The word “affordable” should take into account the relation/balance between:

- an eventual future salary for the person who would work or work more if care services were available
- and the cost of the care service.

Col 121: (REGISTER) Registration at public employment office

Only people who are registered at a public employment office as job-seekers should be coded 1 or 2.

For persons having declared themselves to be seeking employment this question should be the last in the section on seeking employment, as it is important not to give the subject of registration too much emphasis in defining the unemployed.

Since unemployment will basically be defined by the criteria of job search and availability for work the respondents' answer to these questions should not be conditioned by whether or not they are registered at an official employment exchange.

Persons who are in employment and who register in a public employment office to find another job should be coded 2 or 1 (for those who receive complementary unemployment benefits).

Benefits, in this context should be limited to allowances linked with unemployment status (not other social benefits).

The reference period of this question should be end of the reference week.

Main status

Col 122: (MAINSTAT) Main status

The “main activity status” gives each person’s self-perception regarding his/her activity status; for instance, students with small jobs will in general present themselves as students. The reference period for this variable is the reference week.

This question shouldn’t in any case precede the questions on the labour status according to the ILO definition or the questions on the registration at the public employment office.

Code 8 should also be used to classify persons who cannot say they are “carrying out a job or profession” nor fit into other groups but on an extended leave from such a job.

Education and training

Col 123: (EDUCSTAT) Student or apprentice in regular education during the last four weeks

Regular (formal education) is defined as education and training with the following characteristics:

- purpose and format are predetermined
- provided in the system of schools, colleges, universities and other educational institutions
- it normally constitutes a continuous ladder of education.
- it is structured in terms of learning objectives, learning time and learning support
- it is normally intended to lead to a certification recognised by national authorities (qualifying for a specific education/programme).
- corresponds to the programmes covered by the UOE-questionnaires.

The list of national programmes covered by the UOE-questionnaire is found at the address:

http://forum.europa.eu.int/Public/irc/dsis/edtcslibrary?l=/public/unesco_Collection/prgrammes_isc97&vm=detailed&sb=Title

Apprentice: student in regular education but completing his/her studies by apprenticeship foreseen in the educational programme (even if paid).

This variable only covers the regular education system (formal education, including schools, Colleges and universities) and which the respondent has attended sometime during the last 4 weeks period ending with the reference week.

If the interviewee is enrolled as a student or an apprentice in a programme within the regular education system the answer is code 1. This includes modules (short programmes/courses) which may be part of a longer regular education programme and are taken and completed, giving to their graduates the corresponding academic credit, independent of whether the person continues to complete the full programme or not. The field and level of the short programmes/courses will be the same as the programme of which they form part.

For apprentices who in the past 4 weeks are in a period of only 'on-the-job training' or alternate 'on-the-job' and 'in-school learning' within the framework of an alternate (e.g. dual) programme, the answer is code 1, since the person is enrolled in a qualifying programme.

Code 3 (person in regular education but on holidays) applies for students enrolled but on school holidays and for those who will continue their studies after holidays.

The purpose of this code is to eliminate to minimum in the summer interviews doubts about being in regular education (codes 1 and 3 to be considered together). It is very difficult to give precise rules for each case but it could be recommended to take into account the situation of the person in the previous educational period (in spring), what corresponds probably to a natural answer from respondents. The subjective perception of this situation has to be respected in the case if the respondent does not know yet about his/her situation after holidays (exams to be passed in the second session, not yet reply received from the educational institution concerning the new studies, etc).

Col 124: (EDUCLEVL) Level of the current education or training (to 2013 Q4)

Level refers to the programme mentioned in Col 123.

Level is coded according to the International Standard Classification of Education 1997 and consists of only levels without destination (educational or labour market: A-C) or orientation (general, pre-vocational, vocational).

- ISCED 1 Primary education
- ISCED 2 Lower secondary education
- ISCED 3 Upper secondary education
- ISCED 4 Post secondary education, non-tertiary
- ISCED 5 Tertiary education
- ISCED 6 Postgraduate education

Level 4 may not exist in some countries. Please check your ISCED-mapping.

For the persons coded 3 in Col 123 (*Student or apprentice in regular education during the last four weeks*), the educational level of the education or training attended before their holidays.

If the respondent has been enrolled in several educational programmes during the reference period he/she should only give information on the highest level of educational programme.

For EDUCLEVEL from 2014 Q1 see Col 209: (EDUCLEVEL), below.

Col 125/127: (EDUCFILD) Field of the current education or training (to 2013 Q4)

If the respondent has been enrolled in several educational programmes during the reference period he/she should only give information on the field in the highest level of educational programme.

From 2014 onwards this variable is no longer collected.

Col 128: (COURATT) Did you attend any courses, seminars, conferences or receive private lessons or instructions outside the regular education system (hereafter mentioned as taught learning activities, job-related or for personal purposes) within the last four weeks

This variable covers all taught organised learning activities outside the regular education system and which the respondent has attended during the last four weeks ending with the reference week. This is what may be called non-formal education and training.

A non-formal learning activity is defined as being organised like a course, a conference or seminar for which the interviewee has applied and has participated in. It could be for a short or a longer period also with minor breaks.

A non-formal learning activity may exceed the reference period (starting before or finishing later). It includes the following activities:

- Attending a course or a seminar to acquire or to improve skills, knowledge and competence. This includes both courses leading to certificates and courses not leading to certificates. The courses can be attended to improve job related knowledge or improve skills for social and personal purposes.
- Attending a seminar, a course or a lecture to gain vocational guidance and to give a first step to working life (but outside formal education). This includes measures which show and analyse the labour market, his or hers needs and possibilities and which help to choose a job and also measures which improve basic skills/key skills in public or private institutions. The training is taught and within a group on full time basis (or maybe part time) for a shorter period.
- Doing a correspondence course, a tele-teaching or a comparable measure of teacher-supported distance learning to improve skills, knowledge or competence.
- Taking private lessons to improve skills, knowledge and competence, especially as a supplement to formal education. This includes supplementary course by a private tutor. Leisure classes for example studying a language for 'leisure' purposes, even if the qualifications achieved may correspond to (part of) A-level, the attendance should be considered as a non-formal 'course'.

Col 129/131: (COURLEN) Number of hours spent on all taught learning activities within the last four weeks

Duration in number should reflect the number of taught hours only. The definition of total time spent in taught learning by the individual is the total number of hours that the individual has spent on participating in classes, seminars, conferences, lectures, tutorials etc. or receiving instruction or advice. Only the hours of instruction should be included in the total time spent in taught learning, which means that travelling time and homework should be excluded.

Col 132: (COURPURP) Purpose of the most recent taught learning activity

Job-related (professional): the respondent takes part in this activity in order to obtain knowledge and/or learn new skills for a current or a future job, increase earnings, improve job- and/or carrier opportunities in a current or another field and generally improve his/her opportunities for advancement and promotion.

Non job-related (personal/social): the respondent takes part in this activity in order to develop competencies required for personal, community, domestic, social or recreational purposes.

Col 133/135: (COURFILD) Field of the most recent taught learning activity

Although the classification used does not cover the very broad offer of subjects in courses, conferences, seminars etc, it is coded in the same way as programmes under HATFIELD (Col 139/141) and EDUCFILD (Col 125/127) to facilitate implementation and allow aggregation.

Col 136: (COURWORH) Did the most recent taught learning activity take place during paid working hours?

This variable informs on the support to the course by the employer. It refers to the degree that the activity takes place during paid working hours meaning that the working hours are used to attend the activity instead of working. It also includes the case of where a number of working hours are being replaced by learning activity even if the activity itself takes place outside normal working time of the respondent.

If the learning activity takes place outside normal working time and the respondent has received payment for the hours or additional leisure hours, the activity should be coded as during paid working hours.

The answer should only reflect the participation in the course itself and not homework.

For self-employed normal working time instead of paid hours should be taken into account.

Contributing family workers (those workers who hold a 'self-employment' job in a market-oriented establishment operated by a related person living in the same household), who cannot be regarded as partners, voluntary social workers and others working without being paid but attending a course within that area should be coded as "4: Only outside paid hours", as there are no paid working hours.

If a person attends a long course (within the reference period) and does not have a job all the time of the course, there will be two periods of the course: the period where the person is in job and the period where the person is not in job. The answer and coding should reflect the situation in the longest period of the course (again within the reference period).

Col 137/138: (HATLEVEL) Highest level of education or training successfully completed
Level is coded according to the International Standard Classification of Education (ISCED 97). (to 2013 Q4)

Persons with no education (illiterate) should be coded 00.

The expression "level successfully completed" must be associated with obtaining a certificate or a diploma, when there is a certification. In cases where there is no certification, successful completion must be associated with full attendance.

When determining the highest level, both general and vocational education/training should be taken into consideration.

Persons who have not completed their studies should be coded according to the highest level they have completed and should not be coded with a blank.

Code 30 should only be used in those cases in which a distinction a, b, c of ISCED 3 is not possible.

For HATLEVEL from 2014 Q1 see Col 197/199: (HATLEVEL), below.

Col 139/141: (HATFIELD) Field of highest level of education or training successfully completed (to 2013 Q1)

Field is coded according to the "Manual on fields of education and training", EUROSTAT 1999.

ISCED 97 contains 25 two-digit fields of education. The classification used here goes up to a three-digit code in a hierarchical system for classifying fields of education, where the two-digit level is the ISCED 97 fields of education. It is mainly the first two digits that are used in international data collection. However, the third digit gives a more flexible system, and other aggregations based on the third digit may be used in ad hoc data collections to suit specific purposes.

The rule for coding is that the respondents should be coded with the most detailed code possible and only with one code.

For HATFIELD from 2014 Q1 see Col 205/208: (HATFIELD), below.

Col 142/145: (HATYEAR) Year when highest level of education or training was successfully completed (to 2013 Q4)

The expression "level successfully completed" must be associated with obtaining a certificate or a diploma, when there is a certification. In cases where there is no certification, successful completion must be associated with full attendance.

For HATYEAR from 2014 Q1 see Col 200/203: (HATYEAR), below.

Situation one year before survey

The information collected through the following questions in this section, are used to assess mobility of various types: between employment, unemployment and inactivity; of professional status; of economic activity; geographical mobility. Clearly such mobility measures, based upon the respondent's situation at two points in time, can only indicate at most one change in each case (for example, from unemployed to employed), whereas in fact several changes may have taken place over this period (for example, unemployed - employed - inactive - employed). Also, the International Labour Organisation definitions used elsewhere in the survey cannot be applied here, since not all the questions necessary can be asked (for example, availability for work, job search, etc.). The variables "current main status" and "main status one year before the survey" have exactly the same structure in order to permit these comparisons.

Col 146: (WSTAT1Y) Situation with regard to activity one year before survey

The reference period of this question is the week one year before the reference week.

Code 6: Person was conscripted on compulsory military or community service

Although conscripts on compulsory military or community service are excluded from the survey results, this code identifies persons who were conscripts a year before the survey. This is important in identifying labour force entrants.

Col 147: (STAPRO1Y) Professional status one year before survey

For the codification, see variable STAPRO (Col 27)

Col 148/149: (NACE1Y2D) Economic activity of local unit in which person was working one year before survey

See variable NACE3D (Col 29/31). The NACE codes in Annex II are derived from the Statistical Classification of Economic Activities.

Col 150/151: (COUNTRY) Country of residence one year before survey

For coding, see ISO country classification (see Annex IV). This refers to the usual residence one year before.

Col 152/153: (REGION1Y) Region of residence one year before survey

This is based on NUTS 2 (see Annex 1). This refers to the usual residence one year before.

Income

Col 154/155: (INCDECIL) Monthly (take-home) pay from main job

The monthly (take-home) pay is the pay after (provisional, subject to revision later) deduction of income tax and National Insurance Contributions. It includes regular overtime, extra compensation for shift work, seniority bonuses, regular travel allowances and per diem allowances, tips and commission, compensation for meals. Income from investments – assets, savings, stocks and shares... should not be included in monthly wages and salaries.

Holiday bonuses (13th and/or 14th month) and fringe benefits should be considered dividing their amount by 12.

If the job is an occasional job for a short period, the amount should be an estimate of the total earnings from all similar jobs in that month.

The deciles should be calculated and provided once data for the whole year are Collected, checked, and corrected from the non-response.

The first decile (code 01) should refer to people with lowest wages, the 10th (code 10) should refer to people with highest wages.

Technical items relating to the interview

Col 156/159: (REFYEAR) Year of survey

This variable refers to the year in which the Thursday of the reference week belongs.

Col 160/161: (REFWEEK) Reference week

The reference weeks should follow the Norm ISO 8601 which indicates that, according to the Gregorian calendar, the first week of the year is the one that includes the first Thursday of that year.

Concretely:

- Week 1 of 2008 starts the 31st December 2007
- Week 1 of 2009 starts the 29th December 2008
- Week 1 of 2010 starts the 4th January 2010
- Week 1 of 2011 starts the 3rd January 2011

As the year has 365 days (except leap years which have 366 days) and the quarterly survey covers 364 days ($52 \times 7 = 364$), every year the Thursday of the first week of the first quarter moves (backward) to the previous day of the month. After some years that Thursday will be the 31st of December of year Y-1. In this case the sample should be spread over 14 weeks.

Col 162/163: (INTWEEK) Interview week

This information used with reference week gives an indication of the recall period and information on the quality of the answer.

Col 164/165: (COUNTRY) Country

This should be provided according to the coding in Annex IV.

Col 166/167: (REGION) Region of household

This should be provided to the coding system in Annex I, which is based on the Classification of Territorial Units (NUTS). The third and fourth digits of the NUTS code (that is, the level II regional code) should be provided.

Col 168: (DEGURBA) Degree of urbanisation

The concept of "urbanisation" has been introduced to indicate the character of the area where the respondent lives. Three types of area have been identified, as follows:

- densely-populated (Code 1)
- intermediate (Code 2)
- thinly-populated (Code 3)

In the definition of "Degree of urbanisation" there is a criterion of geographical contiguity together with a population threshold. Harmonised, comparable correspondence between the Degree of Urbanisation and NUTS 5 regions has been (re-)defined on the basis of 2001 census data (for Member States and Candidate countries) in 2005.

An "area" consists of a group of contiguous "local areas" where a "local area" corresponds to the following entities in the respective countries:

Belgium	Gemeenten/Communes	
Czech Republic	Obce	6,249
Denmark	Kommuner	271
Germany	Gemeinden	13,176
Estonia	Vald, Inn	241
Greece	Demotiko diamerisma/Koinotiko diamerisma	6,130
Spain	Municipios	8,108
France	Communes	36,678
Ireland	DEDs/Wards	3,440
Italy	Comuni	8,100
Cyprus	Dimoi, koinotites	614
Latvia	Pilsētas, novadi, pagasti	530
Lithuania	Seniūnijos	515
Luxembourg	Communes	118
Hungary	Települések	3,145
Malta	Kunsilli	68
The Netherlands	Gemeenten	489
Austria	Gemeinden	2,381

Poland	Gminy	2,478
Portugal	Freguesias	4,257
Slovenia	Občine	193
Slovakia	Obce	2,928
Finland	Kunnat /Kommuner	446
Sweden	Kommuner	290
United Kingdom	Wards (or parts thereof)	10,679
Bulgaria	Naseleni Mesta	5,340
Croatia		
Romania	Communes+ Municipiu +Orajse	2,951
Turkey	Köy	37,675
Iceland	Sveitarfélag	101
Norway	Kommuner	433
Switzerland	Gemeinden / Communes / Comuni	2,815

The three types of area described above are defined as follows:

Code 1: Densely-populated area

This is a contiguous set of local areas, each of which has a density superior to 500 inhabitants per square kilometre, where the total population for the set is at least 50,000 inhabitants.

Code 2: Intermediate area

This is a contiguous set of local areas, not belonging to a densely-populated area, each of which has a density superior to 100 inhabitants per square kilometre, and either with a total population for the set of at least 50,000 inhabitants or adjacent to a densely-populated area.

Code 3: Thinly-populated area

This is a contiguous set of local areas belonging neither to a densely-populated nor to an intermediate area.

A set of local areas totalling less than 100 square kilometres, not reaching the required density, but entirely enclosed within a densely-populated or intermediate area, is to be considered to form part of that area. If it is enclosed within a densely-populated area and an intermediate area it is considered to form part of the intermediate area.

Col 169/174: (HHNUM) Serial number of the household

Serial numbers are allocated by the national statistical institutes and remain the same for all waves. Records relating to different members of the same household carry the same serial number.

Col 175: (HHTYPE) Type of household

A private household (housekeeping unit concept) is either:

- a) a one-person household, i.e. a person who lives alone in a separate housing unit or who occupies, as a lodger, a separate room (or rooms) of a housing unit but does not join with any of the other occupants of the housing unit to form part of a multi-person household as defined below, or
- b) a multi-person household, i.e. a group of two or more persons who combine to occupy the whole or part of a housing unit and to provide themselves with food

and possibly other essentials for living. Members of the group may pool their incomes to a greater or lesser extent.

The household-dwelling concept (the aggregate number of persons occupying a housing unit) can equally be accepted.

These definitions comprise all persons living in the households surveyed during the reference week, and those persons absent from the household for short periods due to studies, holidays, illness, business trips, etc. In this context short period means less than one year in total (time already elapsed plus the time remaining until the foreseen return).

An institutional household comprises persons whose need for shelter and subsistence are being provided by an institution.

Col 176: (HHINST) Type of institution

This gives information on the distribution of the population by type of collective household.

Col 177/182: (COEFFY) Yearly weighting factor

Each person in the survey sample may be considered to be "representative" of a certain number of other persons not in the sample. The record for each responding individual is therefore assigned a weighting indicating how many persons are in this sense "represented" by this individual.

In order to have consistency between individual and household statistics the same weighting factor should be allocated to all the members of the household.

The '4 first digits' should correspond to whole numbers and the '2 last digits' should correspond to decimal places (without any coma before).

Col 183/188: (COEFFQ) Quarterly weighting factor

In order to have a measure of each variable at quarterly level a quarterly weighting factor should also be calculated. See also notes for Col 183/188 (*Yearly weighting factor*).

Countries still having a yearly survey are requested to fill these columns with the Yearly weighting factor.

Col 189/194: (COEFFH) Yearly weighting factor of the sample for household characteristics (in the case of a sample of individuals)

According to Article 2, § 4. of the regulation for a continuous labour force survey, if the sampling unit is the individual, information can be collected for a sub-sample defined in such way that:

- The reference weeks are uniformly distributed throughout the whole year;
- The number of observations (individuals sampled plus the members of their household) satisfies, for the annual estimates of levels, the reliability criteria.

For countries providing household data using this kind of sub-sample (and only for these countries) this weighting factor should be calculated for each person composing the sub-sample.

Col 195: (INTWAVE) Sequence number of the survey wave

The sequence number of the wave should correspond to the number of times that the individual/household is in the sample. The quarters where the individual/household is not in the sample should be excluded from the counting.

For countries where the sample unit is the household, the sequence number of the survey wave is attached to the household. Therefore it should follow the same pattern for all individuals of the same household. For instance a new person joining the household (and the sample) in wave 2 would be assigned number 2. A person present in wave 1, absent in wave 2 but present in wave 3 would be assigned number 3 when interviewed in wave 3.

Col 196: (INTQUEST) Questionnaire used

Code 1 applies for interviews that do not use the whole questionnaire (yearly + quarterly variables).

Col 197/199: (HATLEVEL) Highest level of education or training successfully completed

Level is coded according to the International Standard Classification of Education (ISCED 97). (from 2014 Q1)

From 2014, the educational attainment level is to be coded according to the International Standard Classification of Education (ISCED 2011) (for more information please see UNESCO site:

<http://www.uis.unesco.org/Education/Pages/international-standard-classification-of-education.aspx>)

Coding should be based on the ISCED integrated mapping which is elaborated in each country. It is a table including information of national educational programmes and qualifications - their main characteristics and coding in ISCED. One column of this table provides coding of the qualification (educational attainment) to be used in the EU-LFS.

All questions about implementation of ISCED in the LFS may be addressed to the national ISCED coordinator who was nominated in each country to ensure coherence of the variable "Educational attainment" in different sources (in particular with AES and SILC).

Provisional guidelines concerning measurement of educational attainment in household surveys are available please see provisional ISCED 2011 guidelines. The final version of these guidelines as well as the ISCED operational manual will be available by summer 2014.

When determining the highest educational level, both general and vocational education should be taken into consideration.

Persons who have not successfully completed their studies should be coded according to the highest level they have completed before and should not be coded with a blank.

Code 300 should only be used for those cases where a distinction of different ISCED level 3 programmes giving (or not giving) access to other levels is not possible.

Qualifications from old educational programmes (not existing anymore) should be classified on the basis of their characteristics at the time of completion.

For HATLEV to 2013 Q4 see Col 137/138 (HATLEVEL), above.

Col 200/203: (HATYEAR) Year when highest level of education or training was successfully completed (from 2014 Q1)

The expression "level successfully completed" must be associated with obtaining a certificate or a diploma, when there is a certification. In cases where there is no certification, successful completion must be associated with full attendance.

For HATYEAR to 2013 Q4 see Col 142/145: (HATYEAR), above.

Col 204 HATVOC Orientation of the programme completed at the highest education level (referred to in HATLEVEL) (new for 2014)

There are two categories of orientation of educational programmes – general and vocational:

General: programmes that are designed to develop learners' general knowledge, skills and competencies, as well as literacy and numeracy skills, often to prepare participants for more advanced education programmes at the same or a higher ISCED level and to lay the foundation for lifelong learning. These programmes are typically school- or college-based. General education includes education programmes that are designed to prepare participants for entry into vocational education but do not prepare for employment in a particular occupation, trade or class of occupations or trades, nor lead directly to a labour market-relevant qualification.

Vocational: programmes that are designed for learners to acquire the knowledge, skills and competencies specific to a particular occupation, trade, or class of occupations or trades. Such programmes may have work-based components (e.g. apprenticeships, dual-system education programmes). Successful completion of such programmes leads to labour market-relevant vocational qualifications acknowledged as occupationally-oriented by the relevant national authorities and/or the labour market.

The question concerns only persons aged 15-34 years, or older but having completed their highest educational level at most 15 years before the date of the interview. In addition, it concerns only persons with educational attainment level of ISCED 3 or 4 (upper secondary or post-secondary non-tertiary).

Double qualifications:

- In case of vocational and general programmes completed at the same ISCED level (and concerning especially ISCED level 3), the most recent qualification should be reported.

- It should be clarified in national guidelines for interviewers/interviewees that there is no hierarchy at ISCED level 3: qualification from the general programme with access to the higher education is not “higher” than the vocational one not giving such access. In the case of multiple qualifications in upper secondary education, the most recent one should be asked.

- In certain countries, some educational programmes provide general and vocational qualifications at the same time; in such cases vocational educational attainment could be prioritised under the assumption that it is of more direct relevance for the labour market.

- In case of two (or more) vocational qualifications, the most recent one should be reported for HATFIELD.

Col 205/208: (HATFIELD) Field of the programme completed at the highest education level (referred to in HATLEVEL) (from 2014 Q1)

Field is coded according to the "Manual on fields of education and training", Eurostat, 1999, please see ISCED manual 1999. ISCED 1997 fields of education are to be used until ISCED 2011 fields of education become available (approved by the UNESCO General Conference around the end 2013). As the ISCED 2011 fields of education will have 4 digits, a leading 0 is added to the current 3-digit ISCED 1997 codes.

ISCED 1997 contains 25 two-digit fields of education. There are 9 broad fields (1-digit), 25 narrow fields (2-digit) and about 80 detailed fields (3-digit).

It is mainly the first two digits that are used in international data collections. However, the third digit gives a more flexible system and other aggregations based on the third digit may be used in ad hoc data collections to suit specific purposes.

The rule for coding is that the respondents should be coded with the most detailed code possible and only with one code.

The coding used for this variable is that of broad fields (1 digit), except for foreign languages (within ‘Humanities, languages and arts’ - 0200) and some fields of particular policy relevance under ‘Science, mathematics and computing’ (0400) where 2 and 3 digits are used.

The rule is that the field should be coded at the most detailed level, e.g. the broad field 0200: ‘Humanities, languages and arts’ includes the detailed fields ‘Foreign languages’ with code 0222. So respondents having ‘Foreign languages’ as their field should be coded with 0222, and not with code 0200.

Similarly the broad field 0400: ‘Science, mathematics and computing’ includes the narrow fields: ‘Life science’ (including ‘Biology and Environmental science’) with codes 0420, ‘Physical science’ (including ‘Physics, Chemistry and Earth science’) with code 0440, ‘Mathematics and statistics’ with code 0460 and the detailed fields: ‘Computer science’ with code 0481 and: ‘Computer use’ with code 0482. So all respondents having any of those narrow or detailed fields as their attainment field

should be coded with the corresponding code. All other respondents with the field of attainment within 'Science, mathematics and computing' should be coded with 0400.

Respondents with a field of attainment in any other broad field should be coded with 0+1digit+'00'.

Inter-disciplinary programmes

'Inter-disciplinary programmes' have the meaning of programmes combining several (generally two) fields of education. For these programmes (*see example 1 to 4*), the 'majority rule' should be used – the subject that dominates decides into which field the programme should be classified. The criterion for "dominating" is normally the time used on the subject.

Example 1: A programme consisting of both 'Computer science' (0481) and 'Computer use' (0482) should be classified according to which of the subjects dominates, that is on which subject most of the time is spent.

Example 2: A programme combining study of life science with study of physical science should be classified according to which of the fields dominates: 0420 'Life science' or 0440 'Physical science'.

In this example subjects fall into the same broad field but in two different narrow fields. Also in this example, the majority rule should be used. The programme is not broad enough to be considered as a 'broad programme'.

Example 3: A programme that mainly includes subjects within the area of social sciences should be allocated to field 0300 ('Social sciences, business and law') even if a certain amount of services within environmental protection technology (field 0851 'environmental protection technology') is included.

In this example, subjects fall into two different broad fields (3 and 8). The majority rule should be used as well: you are more or less obliged to do that as there is no other solution (except 9999).

Programmes aiming at one specific vocational field consisting also of supporting subjects from other fields are *not* considered as broad programmes in this context:

Example 4: In a programme in physics, more time may be devoted to other supporting subjects (language, mathematics, statistics etc.) than the intended subject. However, this programme should be classified as 0440 'Physical science' and not as a broad programme.

In case of double qualifications obtained at the same level, field of the most recent qualification should be reported.

For HATFIELD to 2013 Q4 see Col 139/141 (HATFIELD), above.

Col 209: (EDUCLEVL) Level of the current education or training (from 2014 Q1)

Level of current education refers to the programme in which the student or apprentice is enrolled (Col 123 - EDUCSTAT)

Level of education is coded at 1-digit according to the International Standard Classification of Education 2011:
ISCED 1 - Primary education

ISCED 2 - Lower secondary education
ISCED 3 - Upper secondary education
ISCED 4 - Post-secondary non-tertiary education
ISCED 5 - Short-cycle tertiary education
ISCED 6 - Bachelor's or equivalent level
ISCED 7 - Master's or equivalent level
ISCED 8 - Doctoral or equivalent level

The ISCED integrated mappings, listing national formal educational programmes and qualifications (including all programmes covered by the UOE-questionnaire), should be a basis for allocation of the national programmes – via ISCED 2011 – to the codes of this variable (please see also note on HATLEVEL).

Level 4 may not exist in some countries. Please check your national ISCED mapping.

For the persons coded 3 in EDUCSTAT (student on holiday), the reply should concern the level of education attended before these holidays.

If the respondent has been enrolled in several educational programmes during the reference period, he/she should give information on the highest level of educational programme.

For EDUCLEVEL to 2013 Q4 see Col 124 (EDUCLEVEL), above.

Col 210: (EDUCVOC) Orientation of the educational programme in which the person is enrolled (new 2014 Q1)

Level of current education refers to the programme in which the student or apprentice is enrolled (Col 123 - EDUCSTAT)

There are two categories of orientation of educational programmes – general and vocational:

General: programmes that are designed to develop learners' general knowledge, skills and competencies, as well as literacy and numeracy skills, often to prepare participants for more advanced education programmes at the same or a higher ISCED level and to lay the foundation for lifelong learning. These programmes are typically school- or college-based. General education includes education programmes that are designed to prepare participants for entry into vocational education but do not prepare for employment in a particular occupation, trade or class of occupations or trades, nor lead directly to a labour market-relevant qualification.

Vocational: programmes that are designed for learners to acquire the knowledge, skills and competencies specific to a particular occupation, trade, or class of occupations or trades. Such programmes may have work-based components (e.g. apprenticeships, dual-system education programmes). Successful completion of such programmes leads to labour market-relevant vocational qualifications acknowledged as occupationally-oriented by the relevant national authorities and/or the labour market.

The question concerns only persons attending education at ISCED level 3 and 4 (upper secondary or post-secondary non-tertiary). Information on the orientation of

programmes can be found in the ISCED integrated mappings which show orientation of all programmes (and consequently qualifications) at ISCED level 3 and 4.

Levels of Education and Training

ISCED 1997 (to 2013 Q4)

ISCED 0 - Pre-primary Education

Programs at level 0, (pre-primary) defined as the initial stage of organised instruction is designed primarily to introduce very young children to a school-type environment, i.e. to provide a bridge between the home and a school based atmosphere. Upon completion of these programs, children continue their education at level I (primary education).

ISCED I - Primary Education or First Stage of Basic Education

Programmes at level I are normally designed on a unit or project basis to give students a sound basic education in reading, writing and mathematics along with an elementary understanding of other subjects such as history, geography, natural science, social science, art and music. In some cases religious instruction is featured. The core at this level consists of education provided for children, the customary or legal age of entrance being not younger than five years or older than seven years. This level covers, in principle, six years of full-time schooling.

ISCED 2 - Lower Secondary Education or Second Stage of Basic Education

The contents of education at this stage are typically designed to complete the provision of basic education which began at ISCED level 1. In many, if not most countries, the educational aim is to lay the foundation for lifelong learning and human development. The programmes at this level are usually on a more subject oriented pattern using more specialised teachers and more often several teachers conduct classes in their field of specialisation. The full implementation of basic skills occurs at this level. The end of this level often coincides with the end of compulsory schooling where it exists.

ISCED 3 - (Upper) Secondary Education

This level of education typically begins at the end of full-time compulsory education for those countries that have a system of compulsory education. More specialisation may be observed at this level than at ISCED level 2 and often teachers need to be more qualified or specialised than for ISCED level 2. The entrance age to this level is typically 15 to 16 years. The educational programmes included at this level typically require the completion of some 9 years of full-time education (since the beginning of level 1) for admission or a combination of education and vocational or technical experience.

ISCED 3A: Programmes designed to provide direct access to ISCED 5A;

ISCED 3B: Programmes designed to provide direct access to ISCED 5B;

ISCED 3C: Programmes not designed to lead to ISCED 5A or 5B.

ISCED 4 - Post-Secondary Non Tertiary Education

ISCED 4 captures programmes that straddle the boundary between upper secondary and post-secondary education from an international point of view, even though they might clearly be considered as upper secondary or post-secondary programmes in a national context. These programmes can, considering their content, not be regarded as tertiary programmes. They are often not significantly more advanced than programmes at ISCED 3 but they serve to broaden the knowledge of participants who have already completed a programme at level 3.

Typical examples are programmes designed to prepare students for studies at level 5 who, although having completed ISCED level 3, did not follow a curriculum which would allow entry to level 5, i.e. pre-degree foundation courses or short vocational programmes. Second cycle programmes can be included as well.

ISCED 4A: See text for ISCED 3

ISCED 4B: See text for ISCED 3

ISCED 4C: See text for ISCED 3

LEVEL 5 - First Stage of Tertiary Education (not leading directly to an advanced research qualification)

This level consists of tertiary programmes having an educational content more advanced than those offered at levels 3 and 4. Entry to these programmes normally requires the successful completion of ISCED level 3A or 3B or a similar qualification at ISCED level 4A. They do not lead to the award of an advanced research qualification (ISCED 6). These programmes must have a cumulative duration of at least two years.

ISCED 5A: Programmes that are largely theoretically based and are intended to provide sufficient qualifications for gaining entry into advanced research programmes and professions with high skills requirements.

ISCED 5B: Programmes that are practically oriented/ occupationally specific and are mainly designed for participants to acquire the practical skills and know-how needed for employment in a particular occupation or trade or class of occupations or trades, the successful completion of which usually provides the participants with a labour-market relevant qualification

ISCED 6 - Second Stage of Tertiary education (leading to an advanced research qualification)

This level is reserved for tertiary programmes which lead to the award of an advanced research qualification. The programmes are therefore devoted to advanced study and original research and not based on course-work only.

They typically require the submission of a thesis or dissertation of publishable quality which is the product of original research and represents a significant contribution to knowledge. They prepare graduates for faculty posts in institutions offering ISCED 5A programmes, as well as research posts in government, industry, etc.

ISCED 2011 (from 2014 Q1)

ISCED level 0 Early Childhood Education

Programmes at ISCED level 0, or “early childhood education”, are typically designed with a holistic approach to support children’s early cognitive, physical, social and emotional development and introduce young children to organized instruction outside of the family context. ISCED level 0 refers to those early childhood programmes that have an intentional education component. These programmes aim to develop socio-emotional skills necessary for participation in school and society and to develop some of the skills needed for academic readiness and to prepare them for entry into primary education.

ISCED Level 1 Primary

Programmes at ISCED level 1, or “primary” education, are typically designed to provide students with fundamental skills in reading, writing and mathematics (i.e. literacy and numeracy), and to establish a sound foundation for learning and understanding of core areas of knowledge, personal and social development, preparing for lower secondary education. It focuses on learning at a basic level of complexity with little if any specialisation.

ISCED Level 2 Lower Secondary

Programmes at ISCED level 2, or “lower secondary” education, are typically designed to build upon the learning outcomes from ISCED level 1. Usually, the educational aim is to lay the foundation for lifelong learning and human development on which education systems may systematically expand further educational opportunities. Some education systems may already offer vocational education programmes at ISCED level 2 to provide individuals with skills relevant to employment.

ISCED Level 3 Upper Secondary

Programmes at ISCED level 3, or “upper secondary” education, are typically designed to complete secondary education in preparation for tertiary education, or to provide skills relevant to employment, or both.

ISCED Level 4 Post-Secondary Non-Tertiary

Post-secondary non-tertiary education provides learning experiences building on secondary education and preparing for labour market entry as well as tertiary education. It aims at the individual acquisition of knowledge, skills and competencies below the high level of complexity characteristic of tertiary education. Programmes at ISCED level 4, or “post-secondary non-tertiary” education, are typically designed to provide individuals who completed ISCED level 3 with non-tertiary qualifications that they require for progression to tertiary education or for employment when their ISCED level 3 qualification does not grant such access. For example, graduates from general ISCED level 3 programmes may choose to complete a non-tertiary vocational qualification; or graduates from vocational ISCED level 3 programmes may choose to increase their level of qualification or specialise further. Given the complexity of their content, ISCED level 4 programmes cannot be regarded as tertiary education programmes, although they are clearly post-secondary education.

ISCED Level 5 Short Cycle Tertiary

Programmes at ISCED level 5, or “short-cycle tertiary” education, are often designed to provide participants with professional knowledge, skills and competencies. Typically, they are practically based, occupationally specific and prepare students to enter the labour market. However, programmes may also provide a pathway to other tertiary education programmes. Academic tertiary education programmes below the level of a bachelor programme or equivalent are also classified as ISCED level 5.

ISCED Level 6 Bachelor or Equivalent

Programmes at ISCED level 6, or “bachelor or equivalent”, are often designed to provide participants with intermediate academic and/or professional knowledge, skills and competencies, leading to a first degree or equivalent qualification. Programmes at this level are typically theoretically based but may include practical components and are informed by state of the art research and/or best professional practice. They are traditionally offered by universities and equivalent tertiary educational institutions.

ISCED level 7 Master or Equivalent

Programmes at ISCED level 7, or “master or equivalent”, are often designed to provide participants with advanced academic and/or professional knowledge, skills and competencies, leading to a second degree or equivalent qualification. Programmes at this level may have a substantial research component, but do not yet lead to the award of a doctoral qualification. Typically, programmes at this level are theoretically based but may include practical components and are informed by state of the art research and/or best professional practice. They are traditionally offered by universities and other tertiary educational institutions.

ISCED Level 8 Doctoral or Equivalent

Programmes at ISCED level 8, or “doctoral or equivalent”, are designed primarily to lead to an advanced research qualification. Programmes at this ISCED level are devoted to advanced study and original research and typically offered only by research-oriented tertiary educational institutions such as universities. Doctoral programmes exist in both academic and professional fields.

The summaries given above are necessarily brief extracts from the UNESCO document *REVISION OF THE INTERNATIONAL STANDARD CLASSIFICATION OF EDUCATION (ISCED) - 2011*. The full document, with comprehensive details of ISCED 2011, is available from the Eurostat Reference and Management of Nomenclature (RAMON) website.
http://ec.europa.eu/eurostat/ramon/other_documents/isced_2011/index.cfm?TargetUrl=DSP_ISCED_2011

CORRESPONDENCE BETWEEN ISCED 2011 AND ISCED 1997 LEVELS

In ISCED 2011, level 0 covers early childhood education for all ages, including very young children. Programmes are sub-classified into two categories depending on the level of complexity of the educational content of the programmes: early childhood educational development (code 010) and pre-primary education (code 020). Early childhood educational development programmes (code 010) are generally designed for children younger than three years. It was first introduced in ISCED 2011 and no corresponding category exists in ISCED 1997. Pre-primary education (code 020) corresponds exactly to level 0 in ISCED 1997.

Level 1, primary education, in ISCED 2011 corresponds to level 1 in ISCED 1997.

ISCED 2011 levels 2 and 3, lower secondary and upper secondary education, correspond mainly to levels 2 and 3 in ISCED 1997. However, due to the clarification of criteria and subsidiary criteria, ISCED 2011 may be implemented differently than ISCED 1997 (i.e. with some programmes being classified at different levels than before). Such differences may affect time series data for some countries.

ISCED 2011 simplifies the complementary dimensions at ISCED levels 2 and 3 compared to 1997:

Programme orientation in ISCED 2011 differentiates only between vocational programmes and general programmes. ISCED 1997 classified pre-vocational education separately. Such programmes do not provide labour market relevant qualifications and are now mainly classified as general education;

ISCED 2011 identifies only one group of programmes that provide access to higher ISCED levels. By comparison, ISCED 1997 differentiated access to education at higher ISCED levels in categories A and B, dependent on the type of subsequent education. The ISCED 2011 category “level completion with access to higher ISCED levels” corresponds to the combined categories A and B in ISCED 1997;

ISCED 2011 sub-classifies programmes not providing access to higher ISCED levels into the categories “partial level completion” and “level completion”. These two categories in ISCED 2011 typically correspond to the category C and at ISCED level 3 to categories “C short” and “C long” in ISCED 1997.

ISCED 2011 level 4, post-secondary non-tertiary education, corresponds largely to level 4 in ISCED 1997. However, programmes leading to a qualification equivalent to upper secondary general are classified as level 3 in ISCED 2011, while they were often classified as level 4 in ISCED 1997. In addition, due to the clarification of criteria and subsidiary criteria, ISCED 2011 may be implemented differently than ISCED 1997. Such differences may affect time series data for some countries.

ISCED 2011 simplifies the orientation dimensions at ISCED level 4 as for levels 2 and 3 (see Paragraphs 194, 153, 175). The ISCED 2011 subcategories “access to higher ISCED levels” and “no access to higher ISCED levels” correspond to the destinations A and B, respectively, in ISCED 1997.

ISCED 2011 has four levels of tertiary education, compared to two levels in ISCED 1997. Levels 5, 6 and 7 in ISCED 2011 together correspond to level 5 in ISCED 1997. Level 8 in ISCED 2011 corresponds to level 6 in ISCED 1997.

ISCED 2011 simplifies the complementary dimensions at the tertiary ISCED levels compared to 1997:

At level 5 in ISCED 2011, vocational programmes are differentiated from general programmes at the second digit. In ISCED 1997, this differentiation did not exist. The possibility of distinguishing between academic and professional orientations is also allowed for within ISCED at levels 6-8 once internationally agreed definitions have been developed.

At levels 6 and 7 of ISCED 2011, the third digit of the classification distinguishes between programmes according to programme duration and position in the national degree and qualification structure for the calculation of statistics such as entry and graduation rates. In ISCED 1997, programme orientation or “type of programme” was used to sub-classify ISCED 5A into first degree programmes and second and further degree programmes (ISCED levels 6 and 7 combined in ISCED 2011). The third digit of the programme classification distinguishes between first degree and second or further degrees at both levels.

The text above describing the correspondence between ISCED97 and ISCED11 is taken from the UNESCO document *REVISION OF THE INTERNATIONAL STANDARD CLASSIFICATION OF EDUCATION (ISCED) - 2011*. The full document, with comprehensive details of ISCED 2011, is available from the Eurostat Reference and Management of Nomenclature (RAMON) website. http://ec.europa.eu/eurostat/ramon/other_documents/isced_2011/index.cfm?TargetUrl=DSP_ISCED_2011

Programme Orientation

General Education

Education which is mainly designed to lead participants to a deeper understanding of a subject or group of subjects, especially, but not necessarily, with a view to preparing participants to higher (additional) education at the same or a higher level. Successful completion of these programmes may or may not provide the participants with a labour-market relevant qualification. These programmes are typically school-based. Programmes with a general orientation and not focusing on a particular specialisation should be classified in this category.

Pre-vocational and Pre-technical education

Education which is mainly designed to introduce participants to the world of work and to prepare them for entry into vocational and technical education programmes. Successful completion of such programmes does not yet lead to a labour-market relevant vocational or technical qualification. For a programme to be considered as pre-vocational or pre-technical education, at least 25% of its content has to be vocational or technical. This minimum is necessary to ensure that the vocational subject or the technical subject is not only one among many others.

Vocational and technical education

Education which is mainly designed to lead participants to acquire the practical skills, know-how and understanding necessary for employment in a particular occupation or trade or class of occupations or trades. Successful completion of such programmes leads to a labour-market relevant vocational qualification recognised by the competent authorities in the country in which it is obtained (e.g. Ministry of Education, employers' associations, etc.).

SECTION 8: EUROSTAT AD HOC MODULES

Under Regulation (EC) No 577/98, Eurostat includes a number of variables each year which provide information on aspects of the labour market that do not form part of the standard questionnaire. This set of variables, constitute an "ad hoc module".

Regulations adopting the programme of ad hoc modules	Regulations adopting the specifications	Ad hoc module description	Year	
Regulation 1397/2014 of 22 October 2014 amending Regulation (EU) No 318/2013 adopting the programme of ad hoc modules (2016 to 2018). Regulation 0318/2013 of 8 April 2013 adopting the programme of ad-hoc modules (2016 to 2018).		Reconciliation between Work and Family Life	2018	
		Self employment	2017	
	Commission Implementing Regulation (EU) 2015/459 specifying the technical characteristics of the 2016 ad hoc module on young people on the labour market provided for by Council Regulation (EC) No 577/98		Young people on the labour market	2016
Regulation 0220/2010 of 16 March 2010 adopting the programme of ad hoc modules (2013 to 2015).		Work organisation and working arrangements NB – optional, not run in UK	2015	
		Labour market situation of migrants and their immediate descendants	2014	
		Accidents at work and work-related accidents	2013	
Commission Regulation (EC) No 365/2008 of 23 April 2008 adopting the programme of ad hoc modules covering the years 2010 to 2012	*	Transition from work into retirement	2012	
	*	Employment of disabled people	2011	
	Commission Regulation (EC) No 20/2009		Reconciliation between work and family life	2010
Commission Regulation (EC) No 384/2005 of 7 March 2005 adopting the programme of ad hoc modules, covering the years 2007 to 2009	Commission Regulation (EC) No 207/2008	Transition from school to work life	2009	
	Commission Regulation (EC) No 102/2007	Labour Market situation of migrants and the immediate descendants of migrants	2008	
	Commission Regulation (EC) No 391/2008 (amendment concerning BG and RO)			
	Commission Regulation (EC) No 341/2006		Accidents at work and work-related health problems	2007
Commission Regulation (EC) No 246/2003 of 10 February 2003 adopting the programme of ad hoc modules, covering the years 2004 to 2006	Commission Regulation (EC) No 388/2005	Transition from work into retirement	2006	
	Commission Regulation (EC) No 29/2004	Reconciliation between work and family life	2005	
	Commission Regulation (EC) No 247/2003	Work organisation and working time arrangements	2004	
Commission Regulation	Commission Regulation	Lifelong learning	2003	

Labour Force Survey - United Kingdom

<u>(EC) No 1626/2000</u> of 24 July 2000 adopting the programme of ad hoc modules, covering the years 2001 to 2004	<u>(EC) No 1313/2002</u>		
	<u>Commission Regulation (EC) No 1566/2001</u>	Employment of disabled people	2002
	<u>Commission Regulation (EC) No 1578/2000</u>	Length and patterns of working time	2001
<u>Commission Regulation (EC) No 1924/1999</u> of 8 September 1999 adopting the programme of ad hoc modules, covering the years 2000 to 2002	<u>Commission Regulation (EC) No 1925/1999</u>	Transition from school to working life	2000
	<u>Commission Regulation (EC) No 1571/98</u>	Accidents at work and occupational diseases	1999

* Under discussion

For more information on Eurostat ad hoc modules: -

http://circa.europa.eu/irc/dsis/employment/info/data/eu_lfs/LFS_MAIN/LFS/lfs_regulations.htm

Explanatory notes and model questionnaires for the Eurostat ad hoc modules are available here:

http://ec.europa.eu/eurostat/statistics-explained/index.php/EU_labour_force_survey_-_ad_hoc_modules

Details of Eurostat ad hoc modules can be found in the LFS User Guide vol. 9a, available here:

<https://www.ons.gov.uk/employmentandlabourmarket/peopleinwork/employmentandemployeetypes/methodologies/labourforcesurveyuserguidance>

Section 9:
EUROSTAT DERIVED VARIABLE FLOWCHARTS

An index of EU-LFS variables flowcharts is given on pp. 406 - 408

HHSEQNUM (EPERSNO): Sequence number within household

Columns 1/2

PAGE 1 OF 1

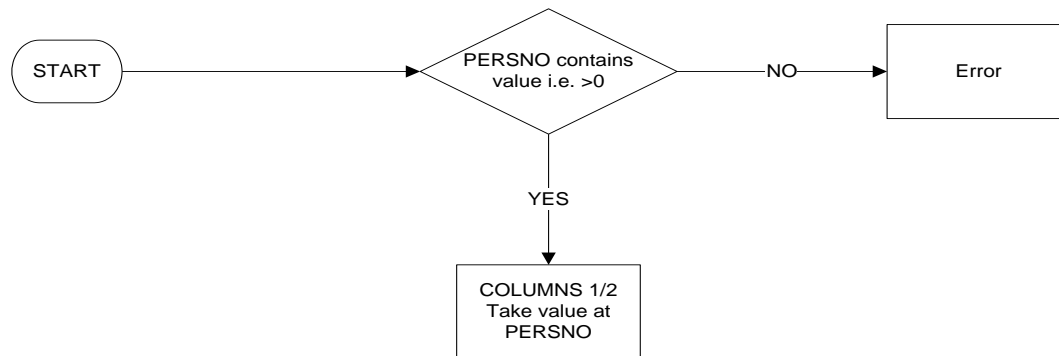

KEY	
01 - 98	Two-digit sequence number allocated to each member of the household

HHLINK (ERELHOH): Relationship to reference person in the household

Column 3

PAGE 1 OF 2

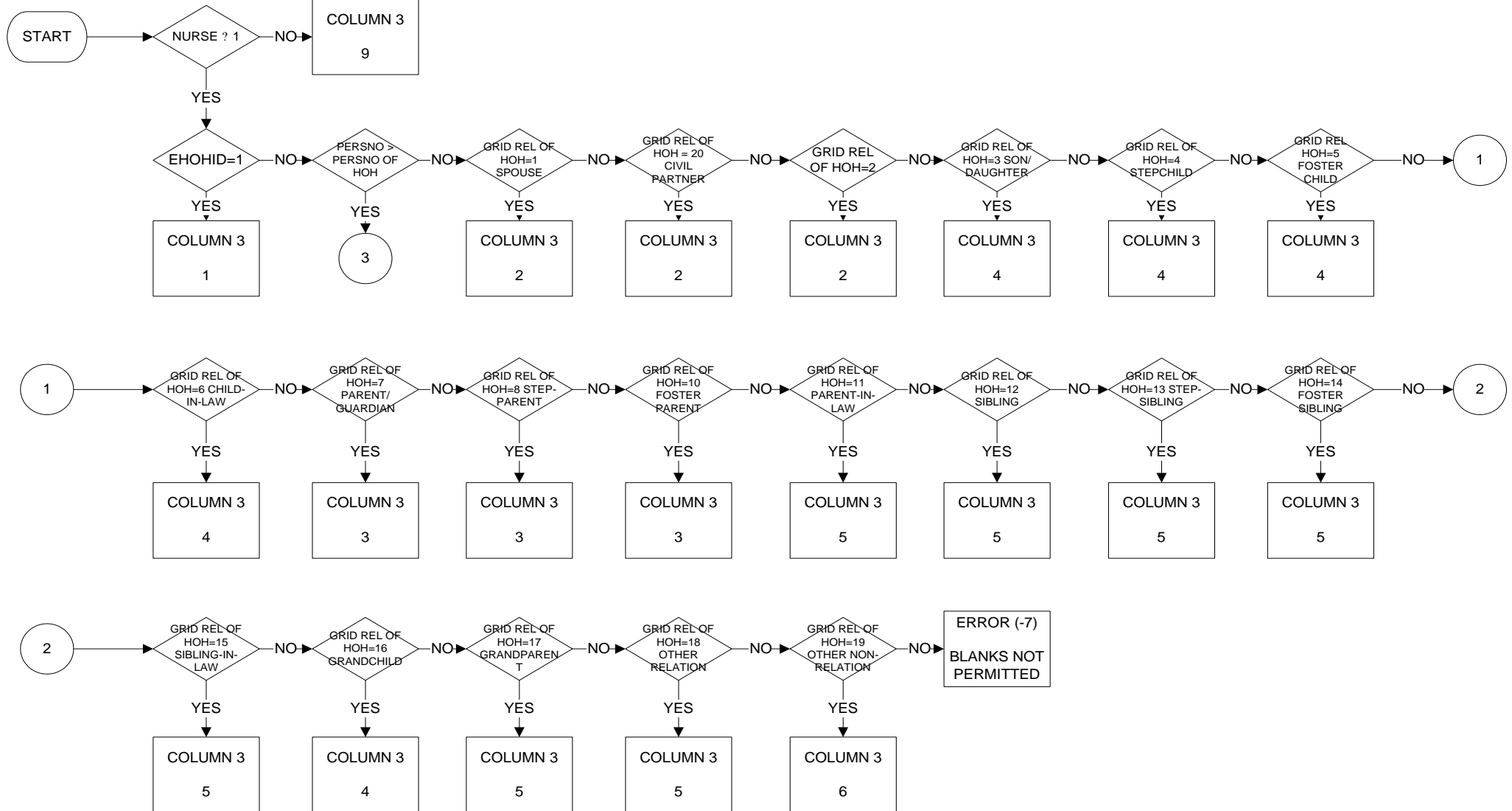

HHLINK (ERELHOH): Relationship to reference person in the household

Column 3

PAGE 2 OF 2

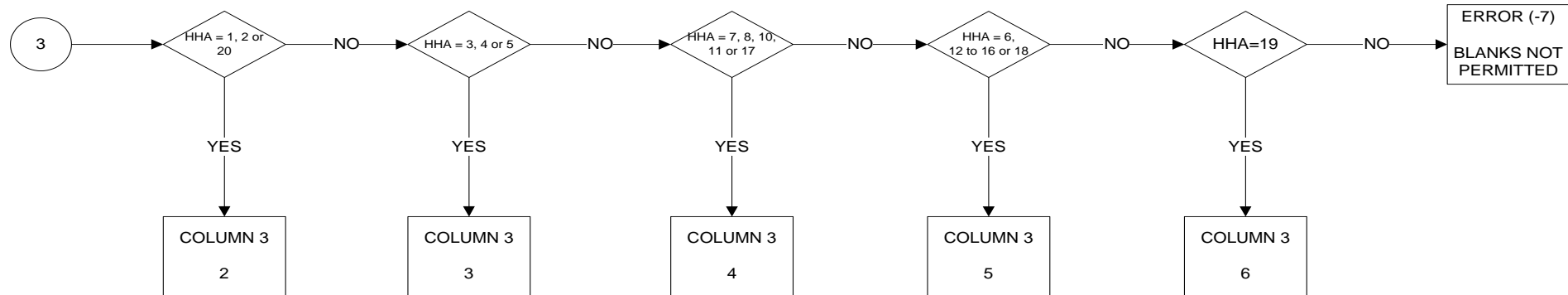

KEY	
1	Reference person
2	Spouse (or cohabiting partner) of reference person
3	Child of reference person (or of his/her spouse or cohabiting partner)
4	Ascendent relative of reference person (or of his/her spouse or cohabiting partner)
5	Other relative
6	Other
9	Not applicable (HHTYPE ? 1, 3)

HHSPOU (ESPOUSE): Sequence number of spouse or partner

Columns 4/5

PAGE 1 OF 2

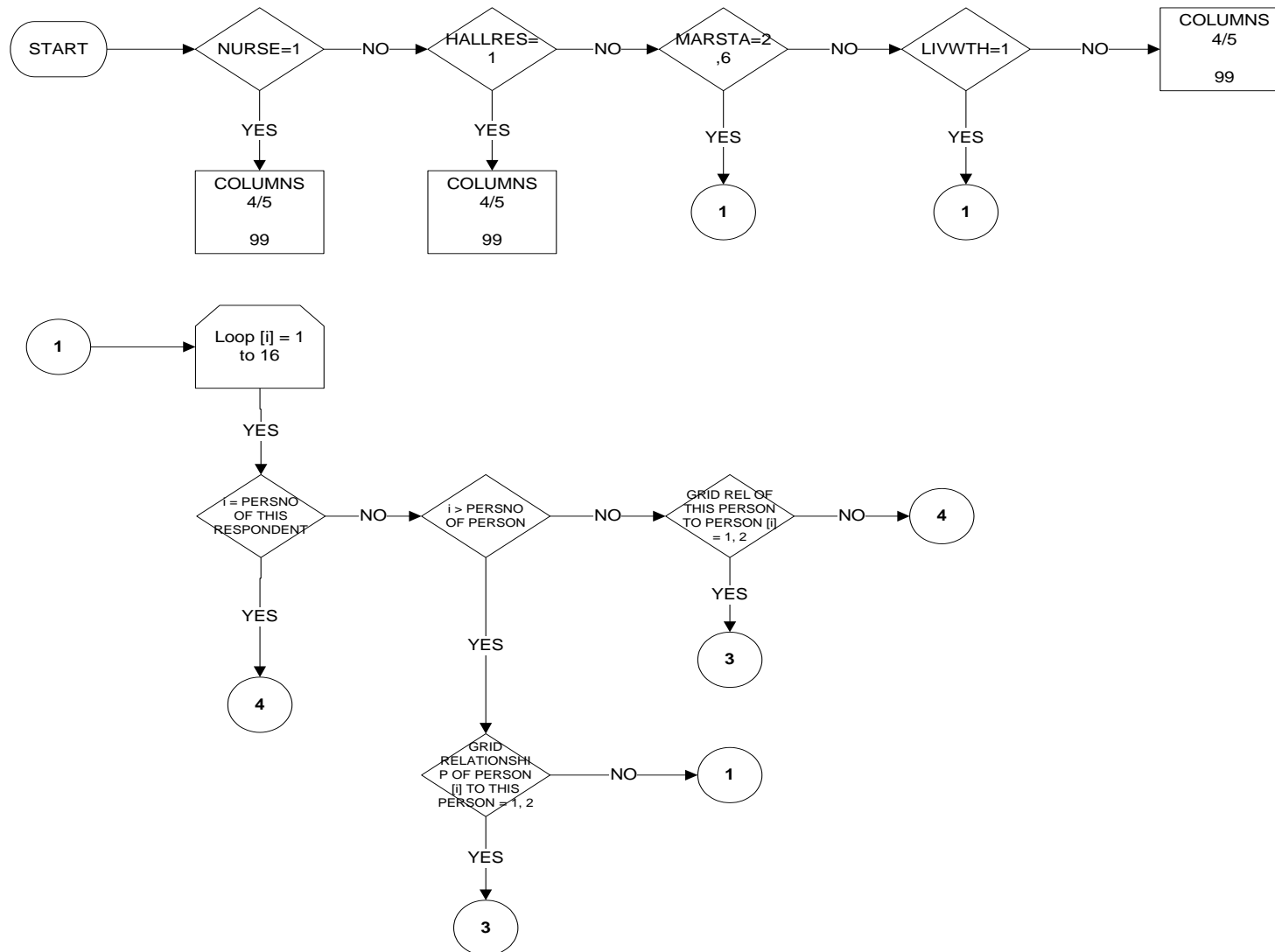

HHSPOU (ESPOUSE): Sequence number of spouse or partner

Columns 4/5
PAGE 2 OF 2

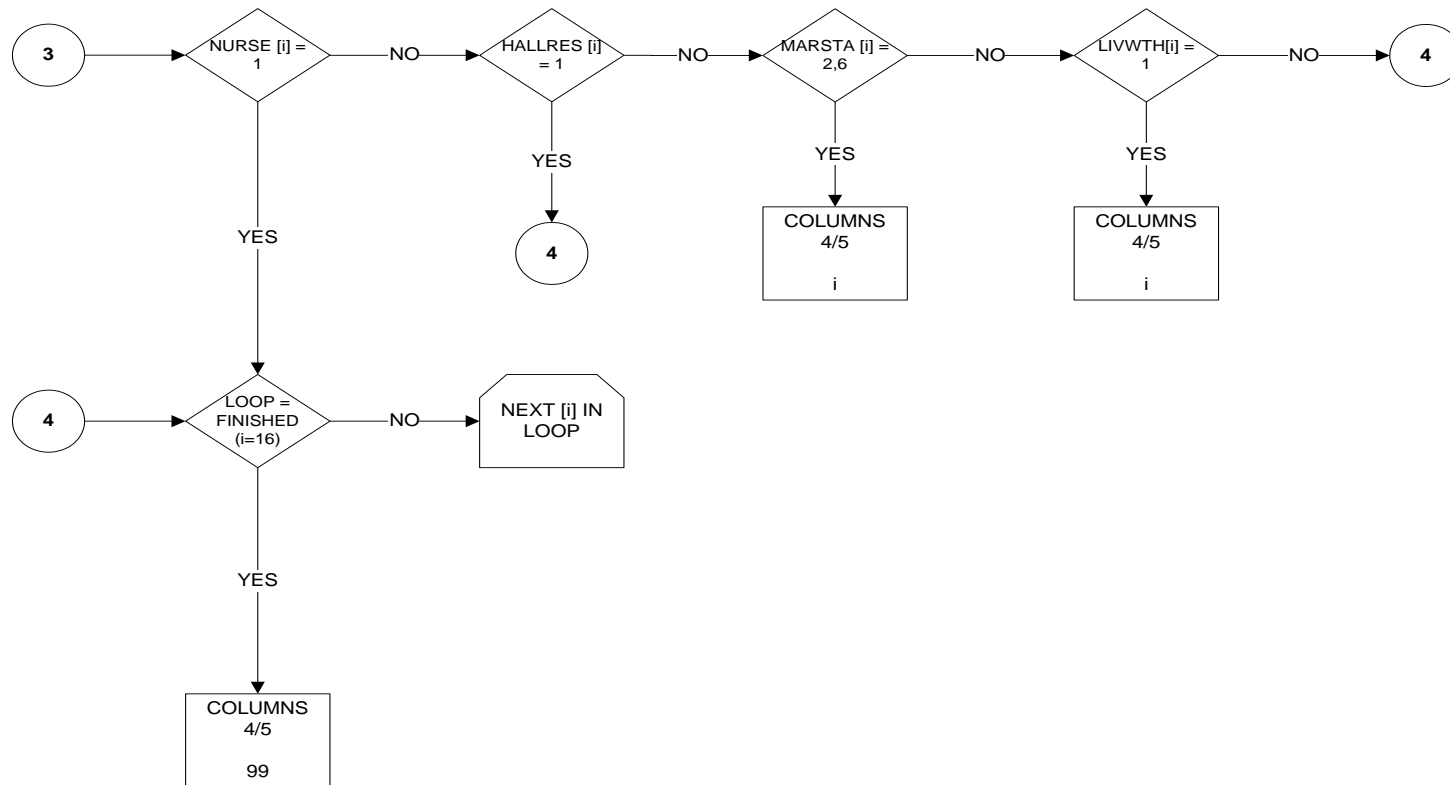

KEY	
01-98	Sequence number of spouse or cohabiting partner in the household
99	Not applicable (person does not belong to a private household, or has no partner, or the partner does not belong to this private household)

HHFATH (EFATHER): Sequence number of father

Columns 6/7

PAGE 1 OF 1

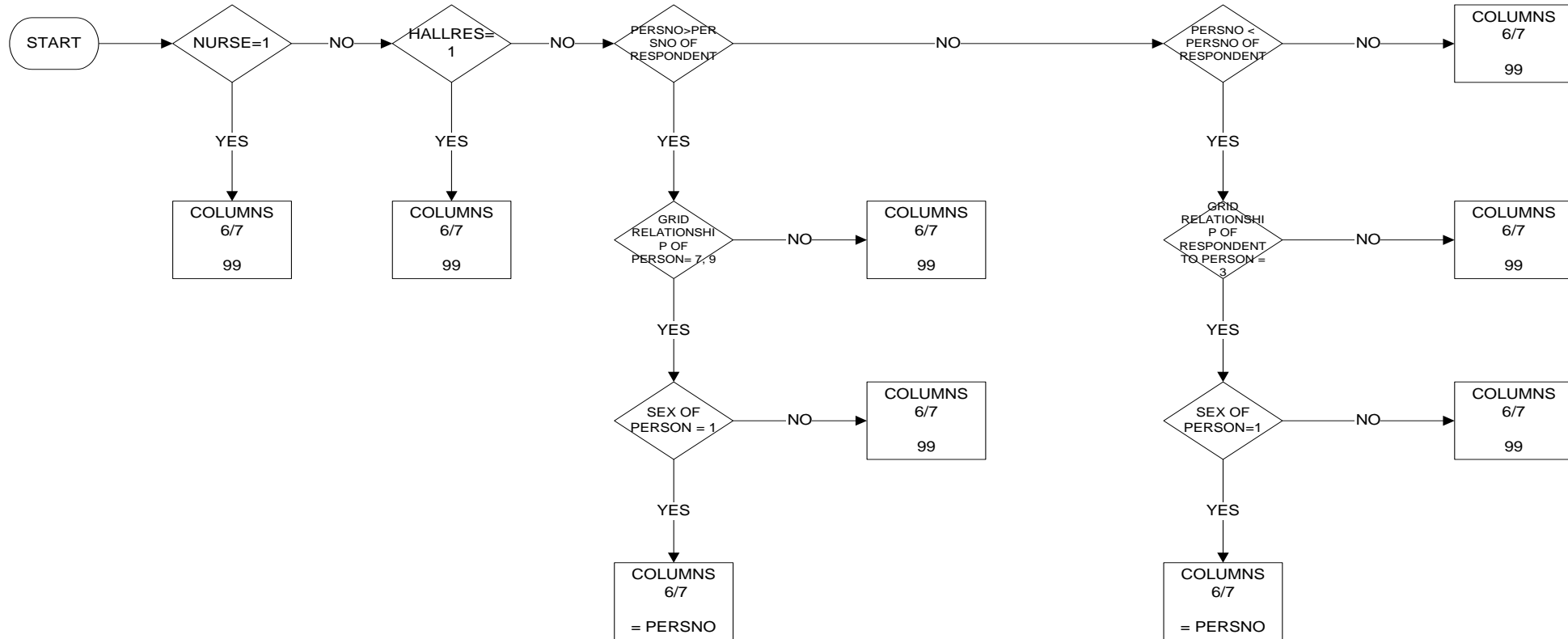

KEY	
01 - 98	Sequence number of father in the household
99	Not applicable (person does not belong to a private household, or the father does not belong to this private household)

HHMOTH (EMOTHER): Sequence number of mother

Columns 8/9
PAGE 1 OF 1

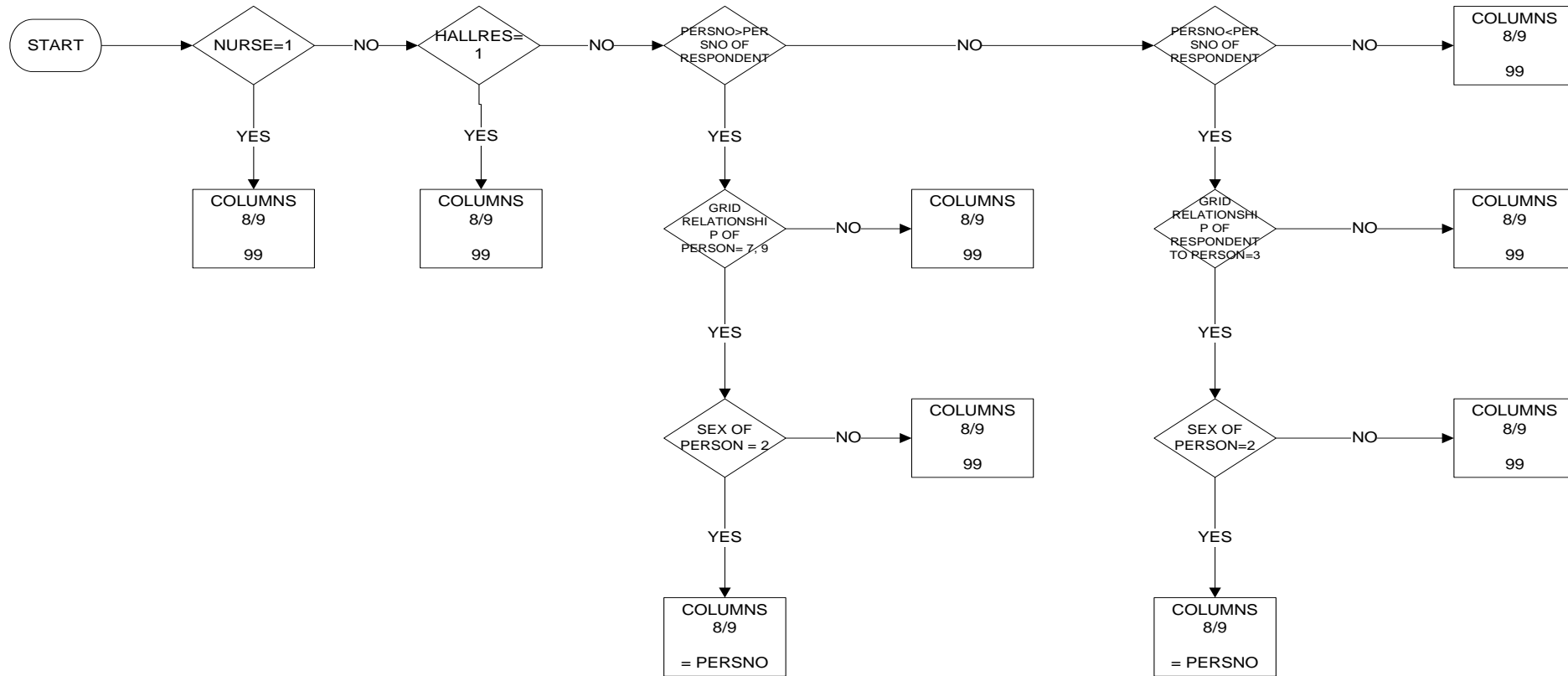

KEY
 01 - 98 Sequence number of mother in the household
 99 Not applicable (person does not belong to a private household, or the mother does not belong to this private household)

SEX (ESEX): Sex
Column 10
PAGE 1 OF 1

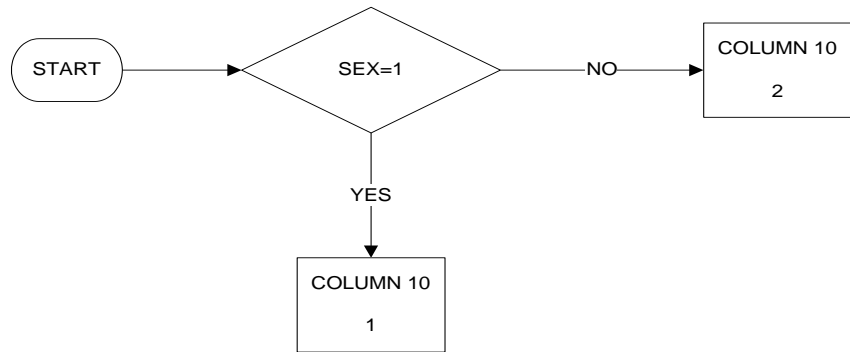

KEY	
1	Male
2	Female

YEARBIR (EYOB): Year of birth

Column 11/14

PAGE 1 OF 1

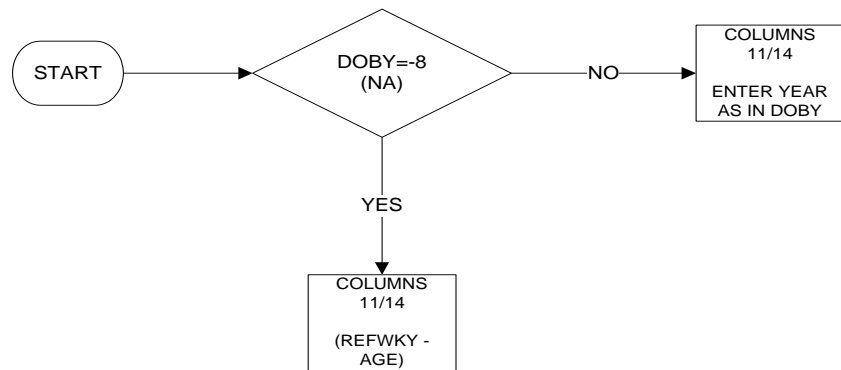

Notes:

The 4 digits of year of birth are entered

DATEBIR (EDOB): Date of birth in relation to end of reference week

Column 15

PAGE 1 OF 1

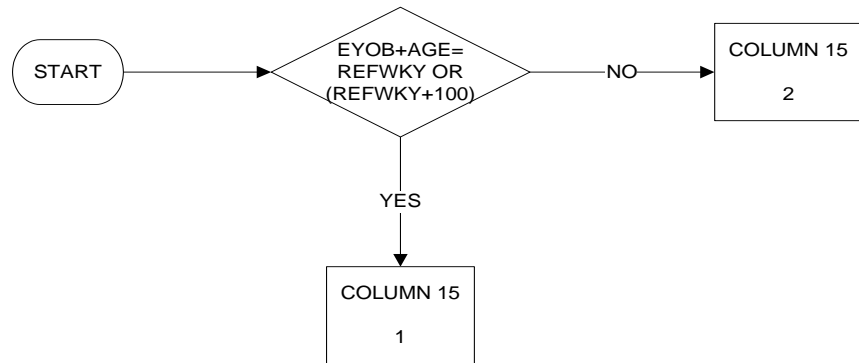

KEY

- 1 Person's birthday falls between 1 January and the end of the reference week.
- 2 Person's birthday falls after the end of the reference week.

Notes

Derive EYOB first

MARSTAT (EMARSTAT): Marital Status

Column 16
PAGE 1 OF 1

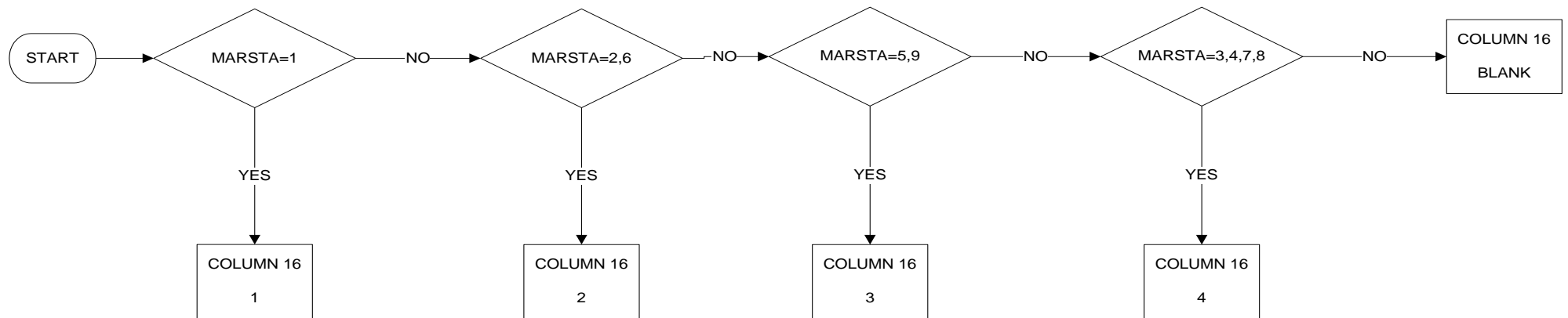

KEY	
1	Single
2	Married
3	Widowed
4	Divorced or legally separated
Blank	No answer

NATIONAL (ENAT): Nationality

Columns 17/18

PAGE 1 OF 7

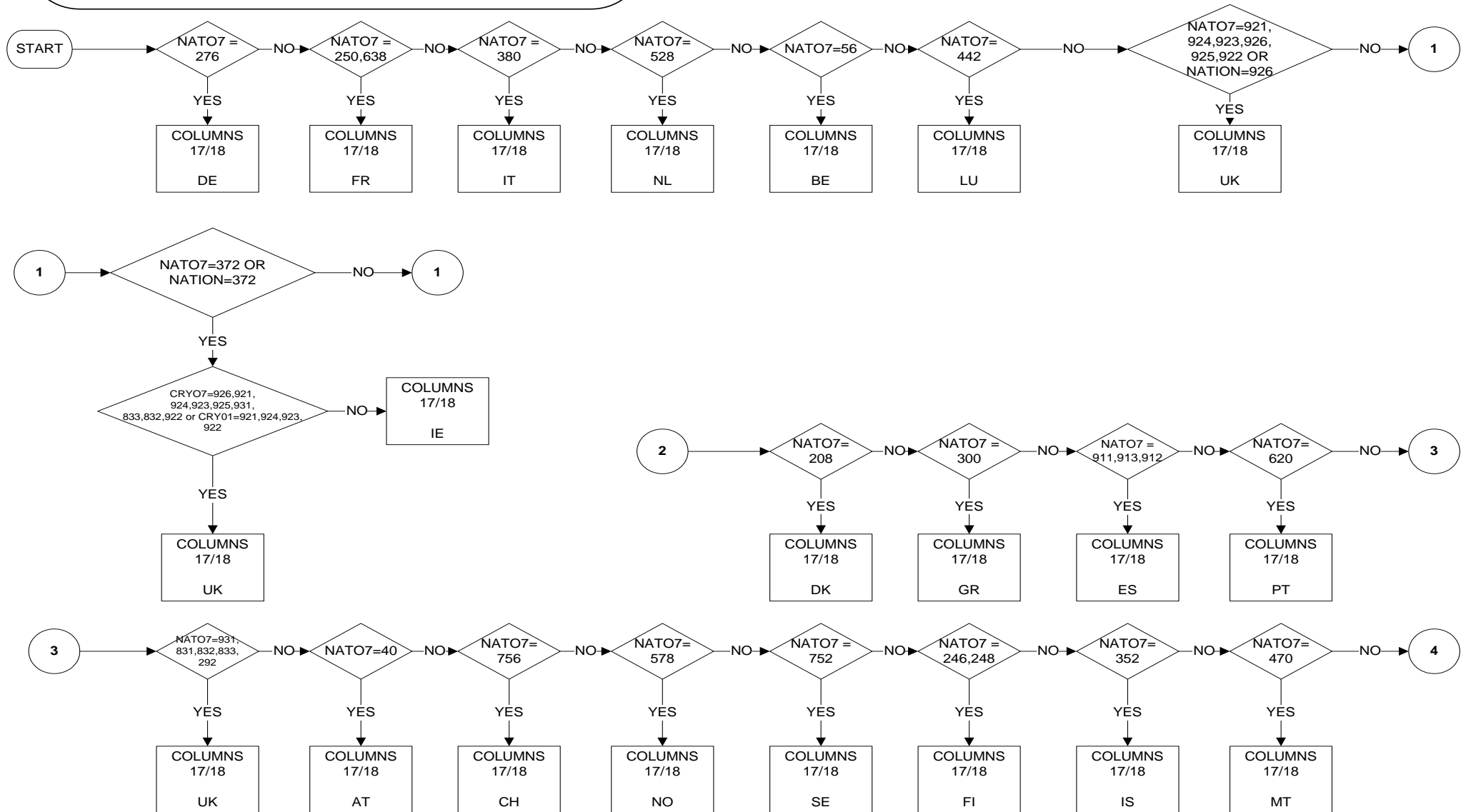

NATIONAL (ENAT): Nationality

Columns 17/18

PAGE 2 OF 7

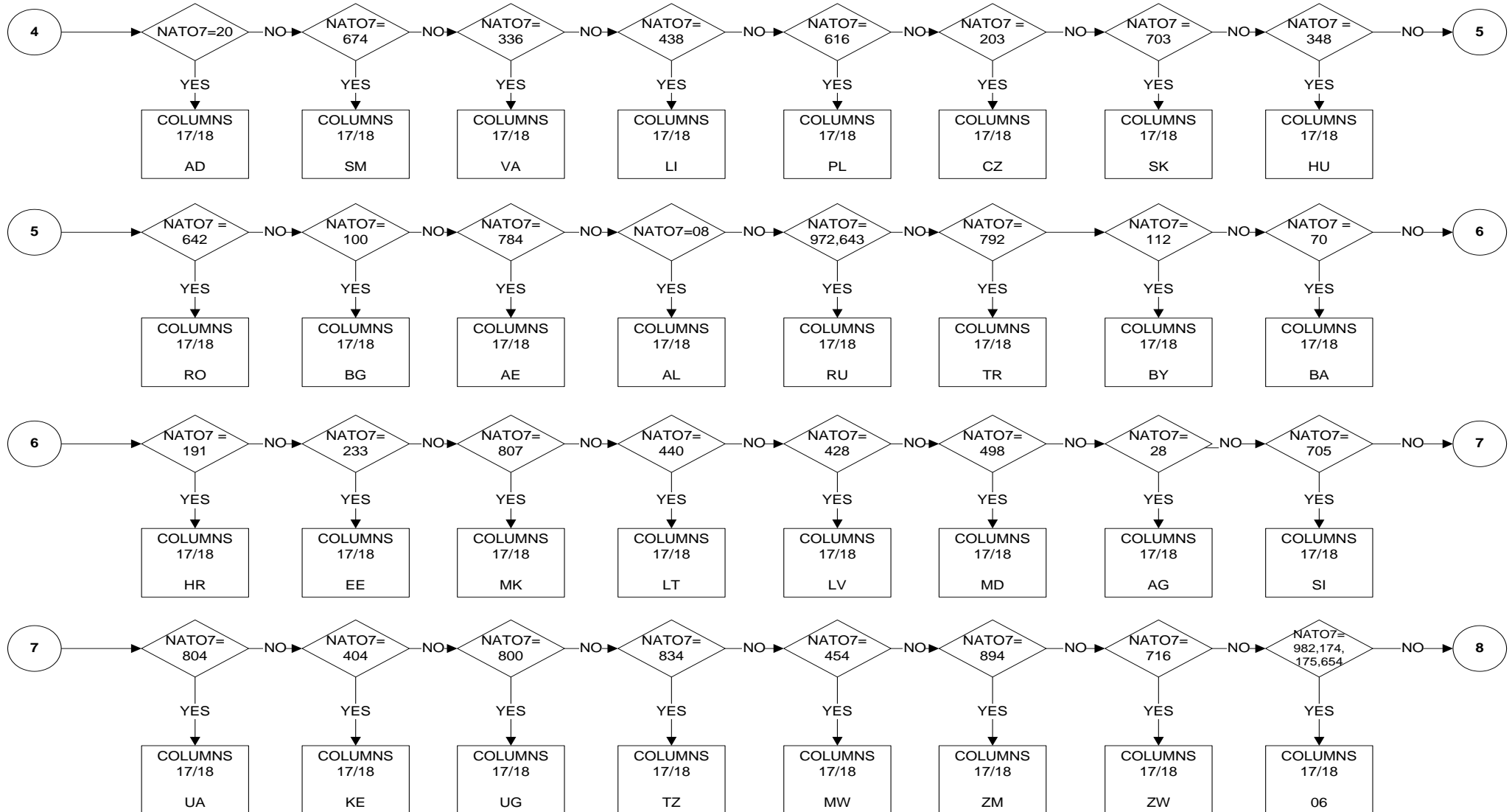

NATIONAL (ENAT): Nationality

Columns 17/18

PAGE 3 OF 7

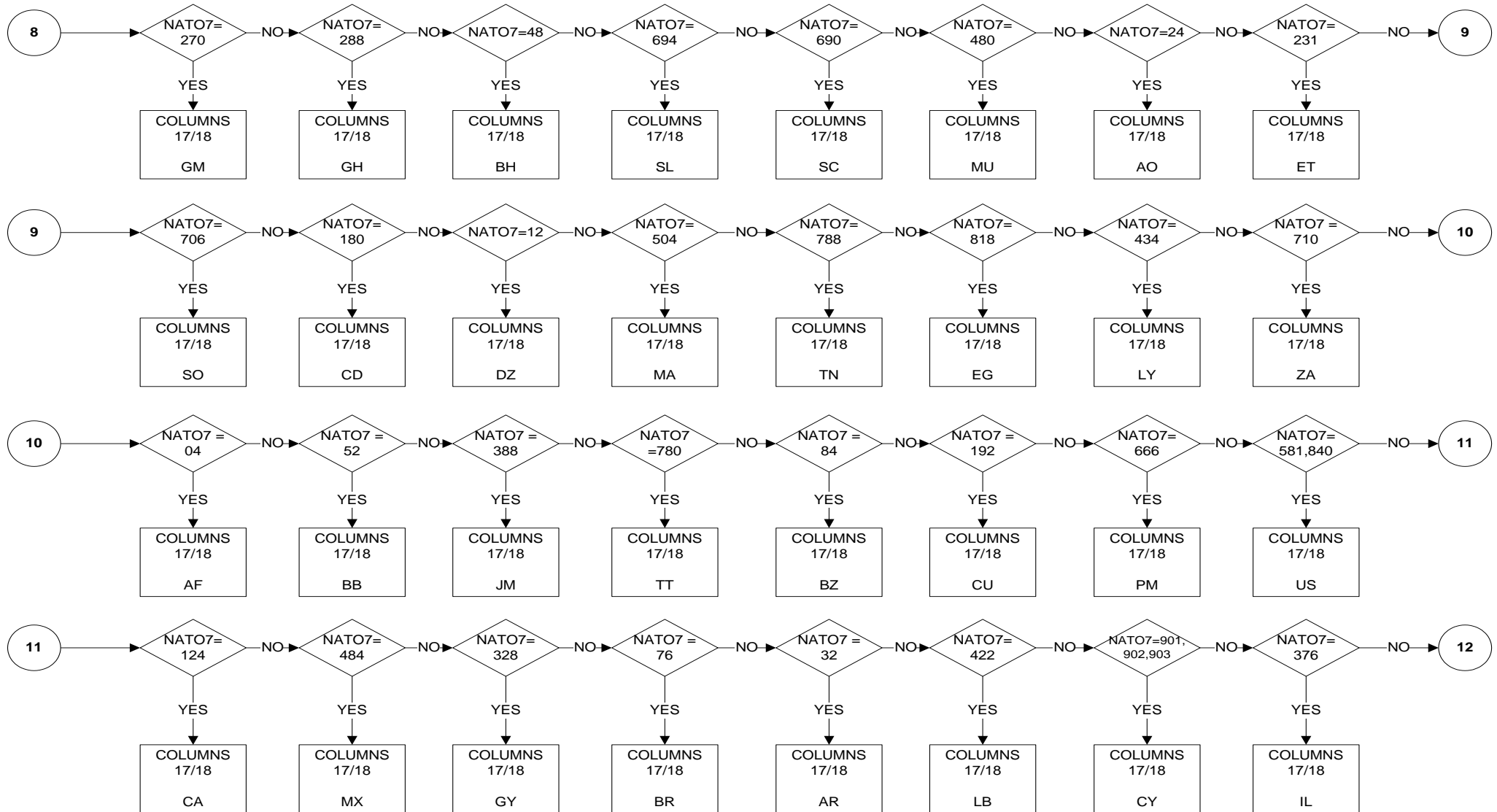

NATIONAL (ENAT): Nationality

Columns 17/18

PAGE 4 OF 7

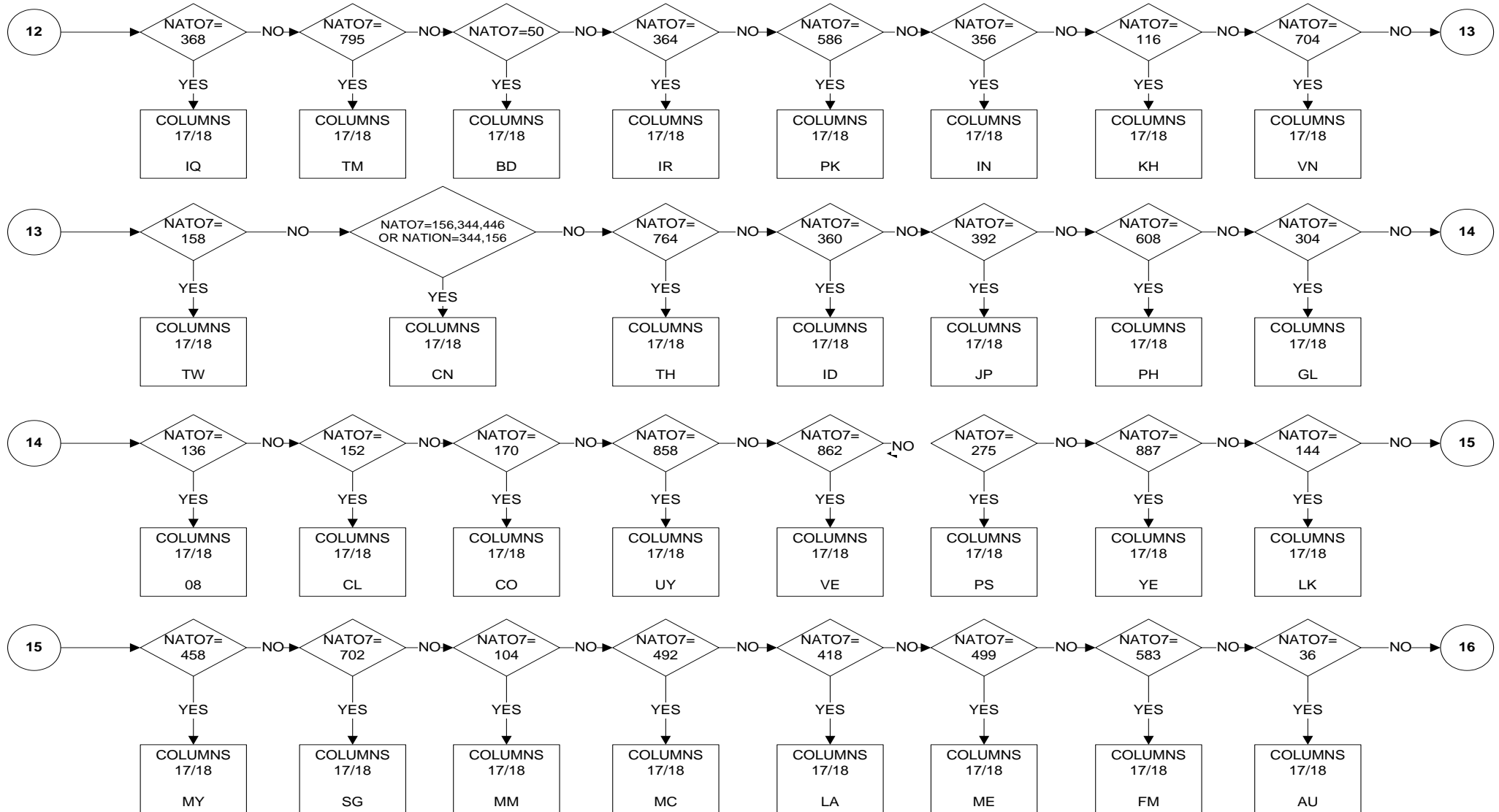

NATIONAL (ENAT): Nationality

Columns 17/18

PAGE 5 OF 7

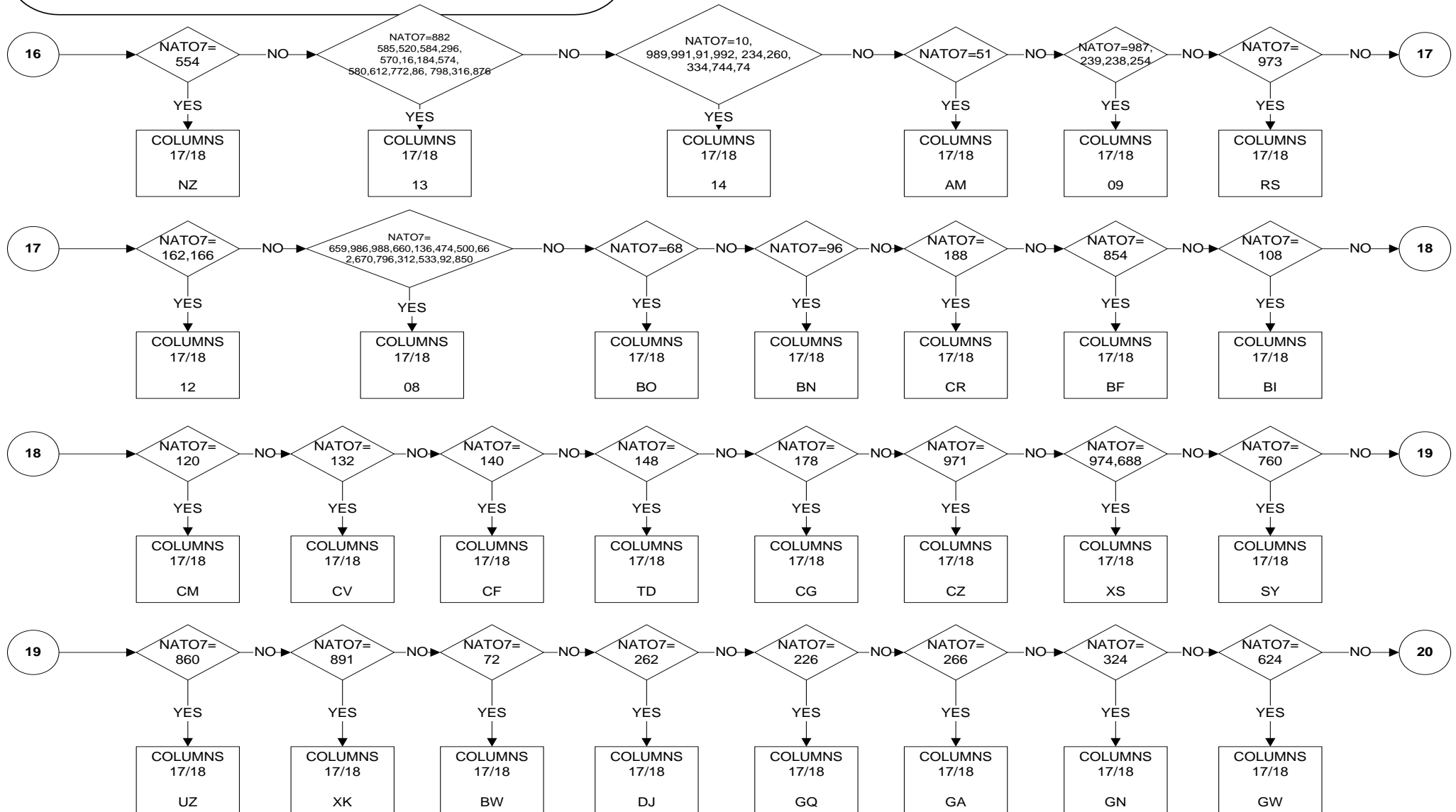

NATIONAL (ENAT): Nationality
Columns 17/18
 PAGE 6 OF 7

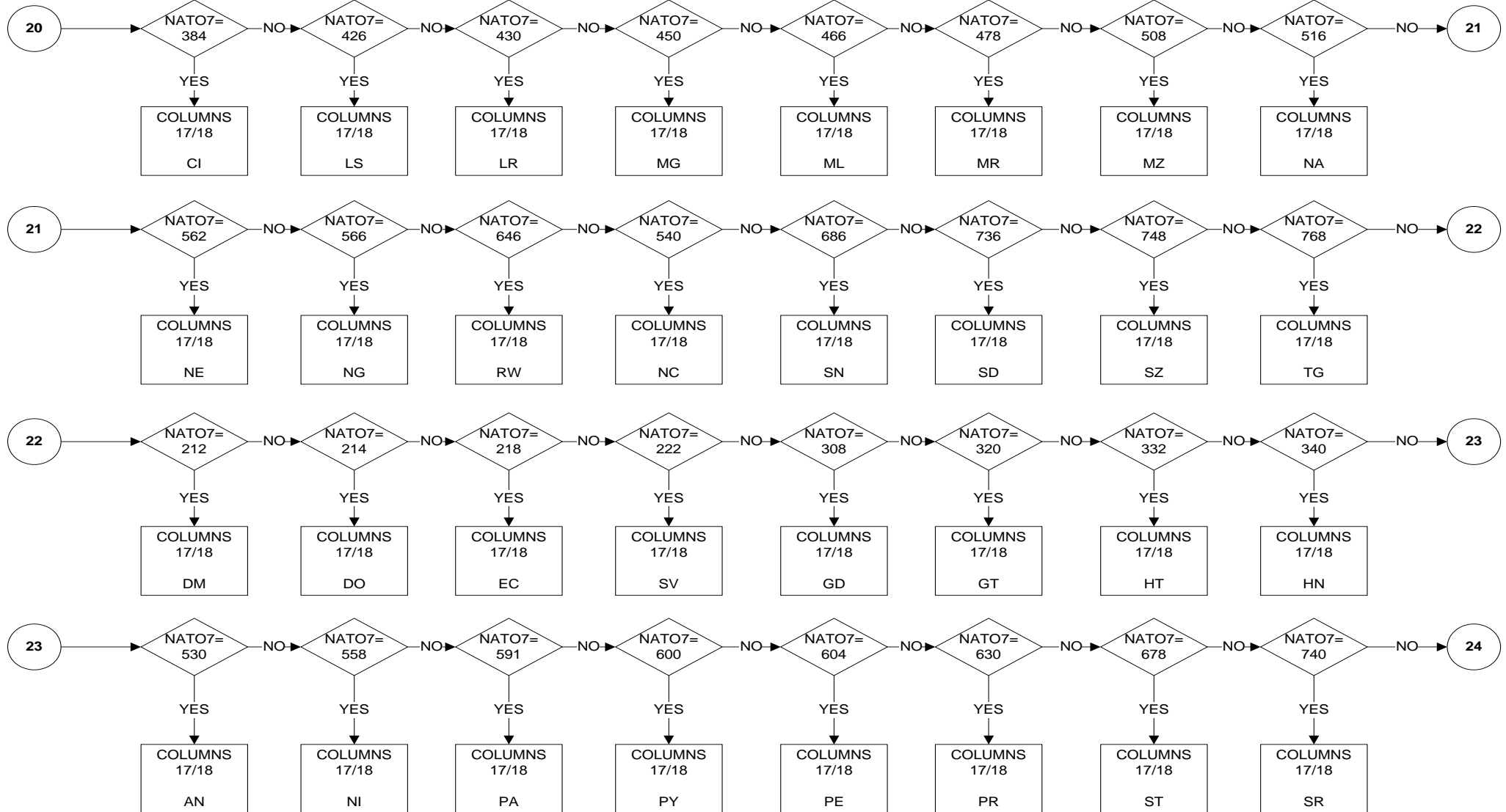

NATIONAL (ENAT): Nationality

Columns 17/18

PAGE 7 OF 7

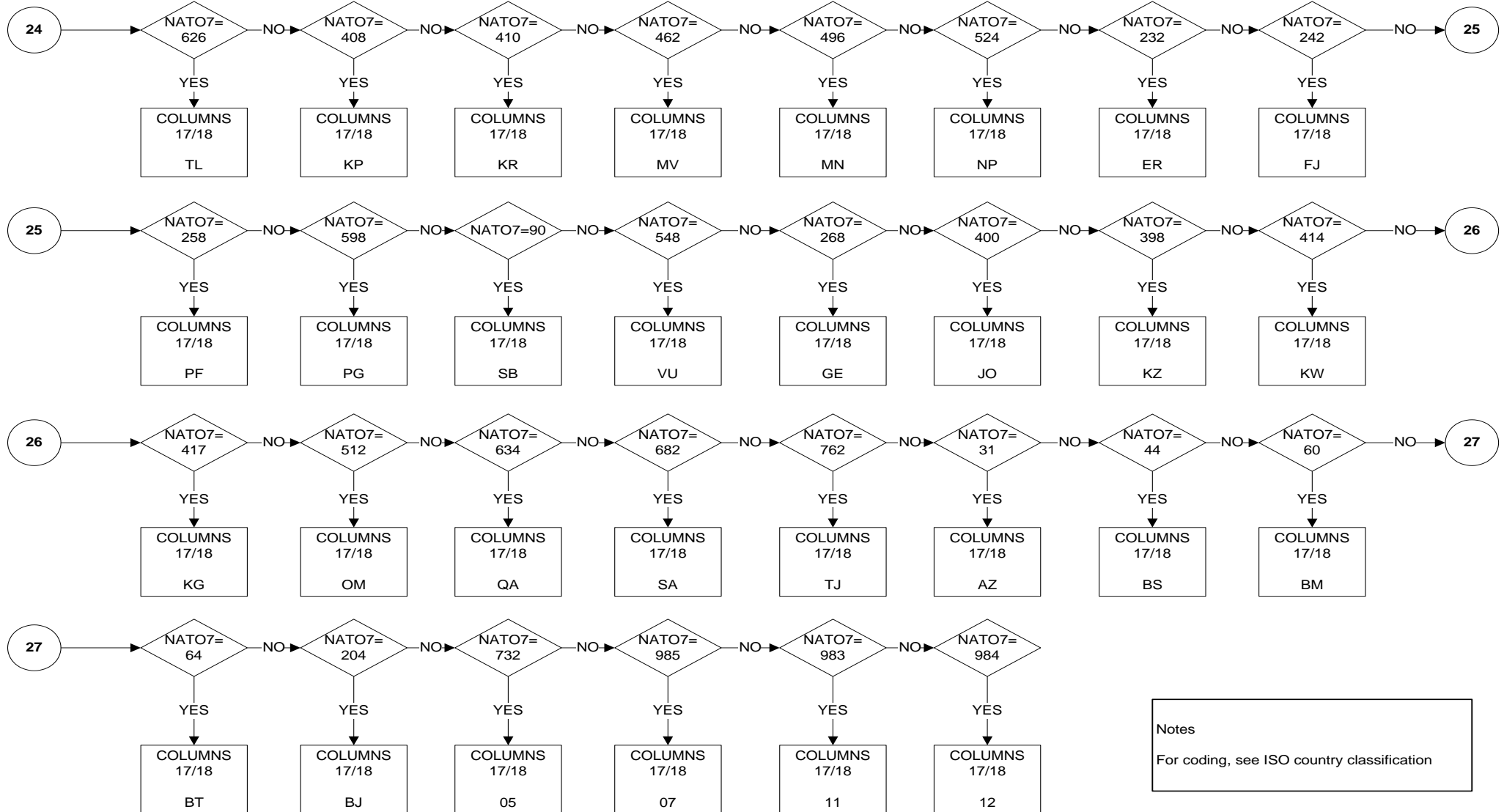

Notes
For coding, see ISO country classification

YEARESID (EYRSRES): Years of residence in this country

Column 19/20

PAGE 1 OF 2

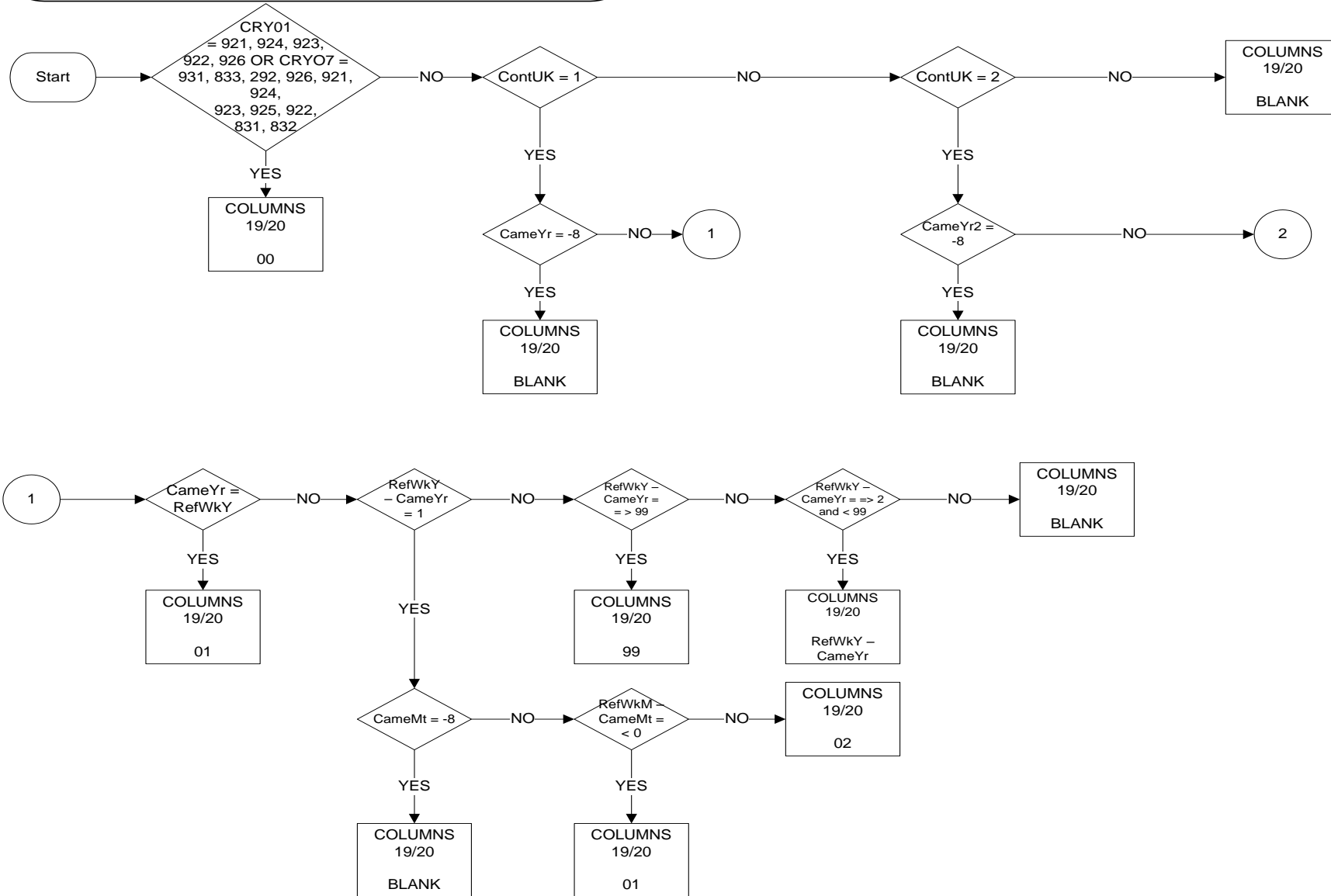

YEARESID (EYRSRES): Years of residence in this country

Column 19/20

PAGE 2 OF 2

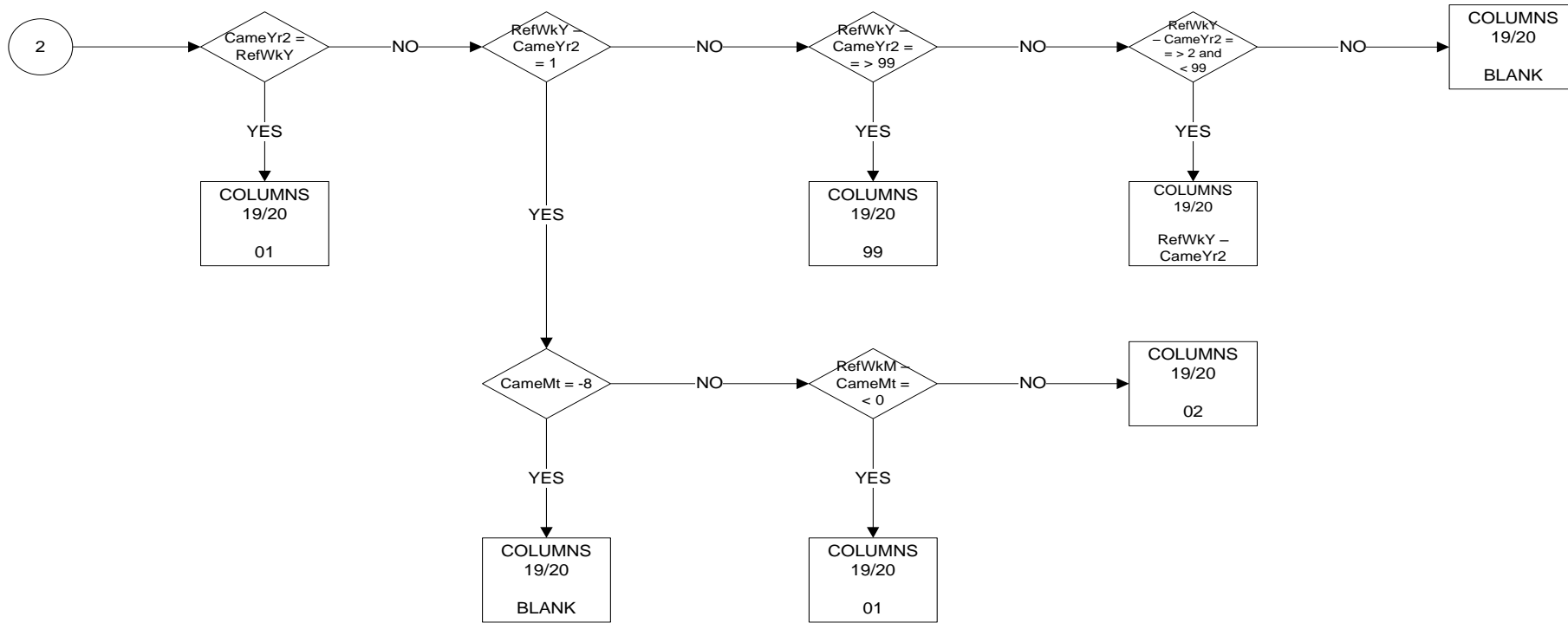

KEY

- 00 Born in this country
- 01-99 Number of years of residence in this country
- BLANK No answer

Notes

Channel Island (7), Isle of Man (8) & Gibraltar (40) have been added to UK because they are not specified in 2006 codification

COUNTRYB (ECOB): Country of Birth

Columns 21/22

PAGE 1 OF 7

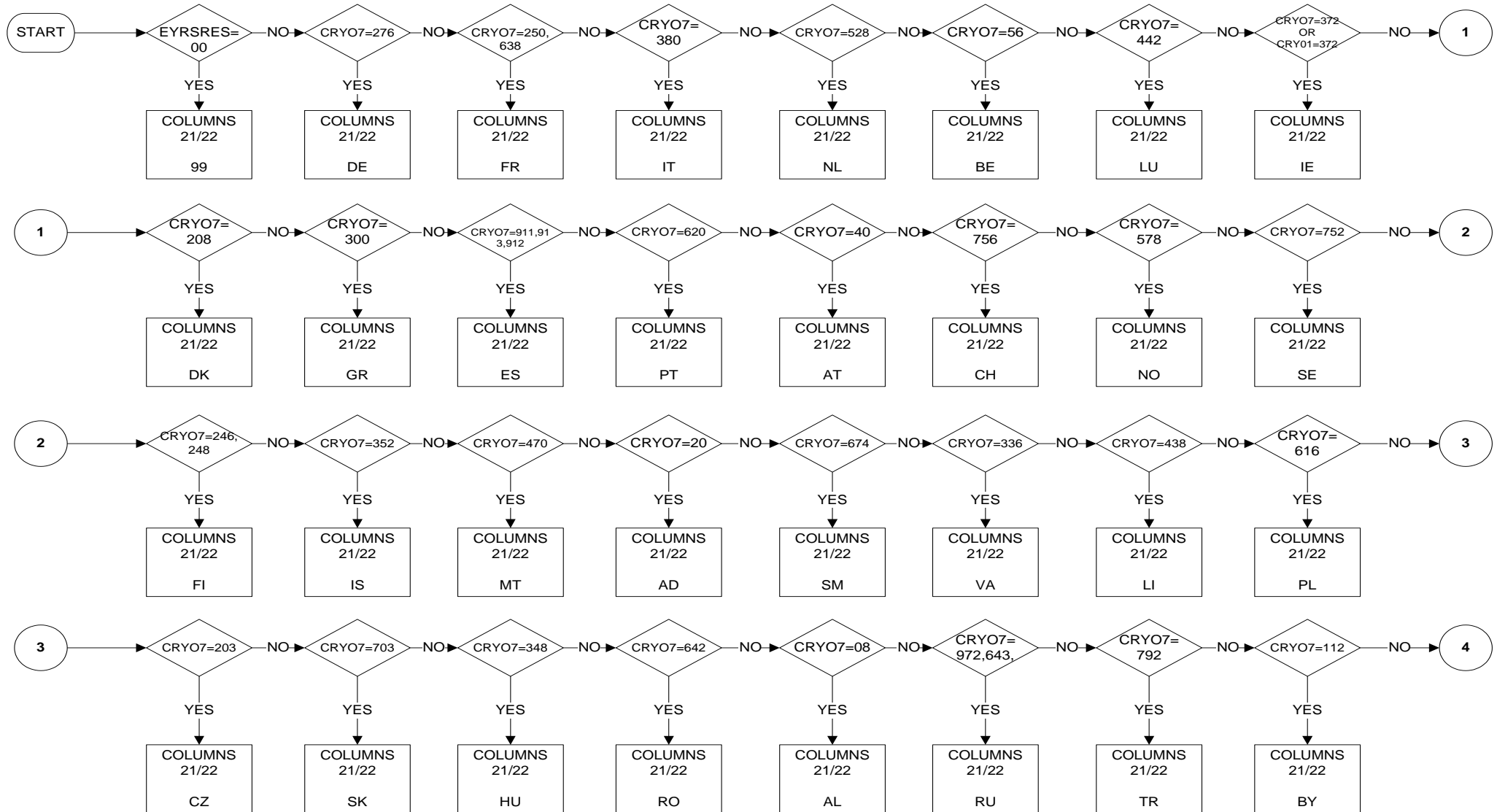

COUNTRYB (ECOB): Country of Birth

Columns 21/22

PAGE 2 OF 7

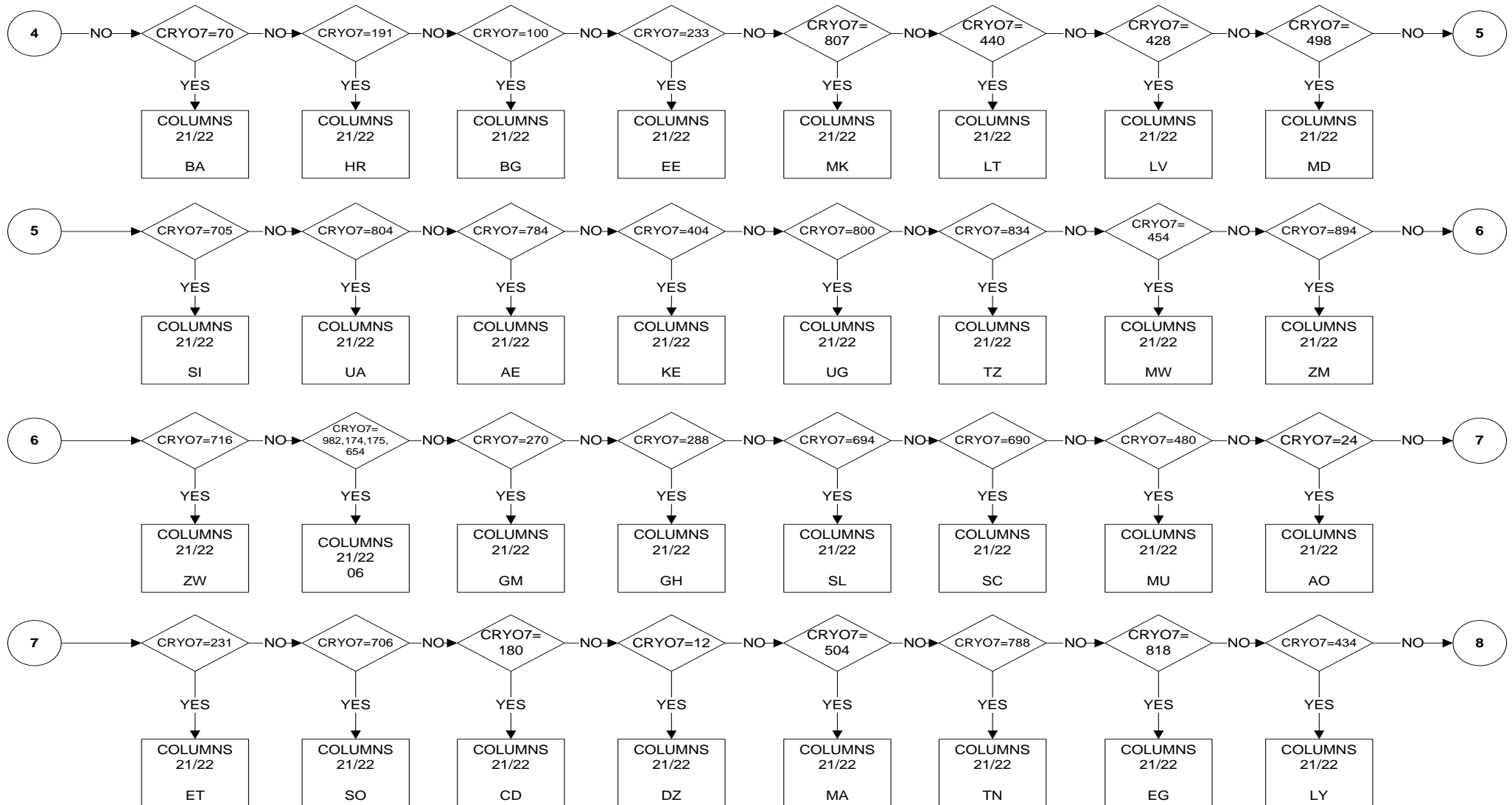

COUNTRYB (ECOB): Country of Birth

Columns 21/22

PAGE 3 OF 7

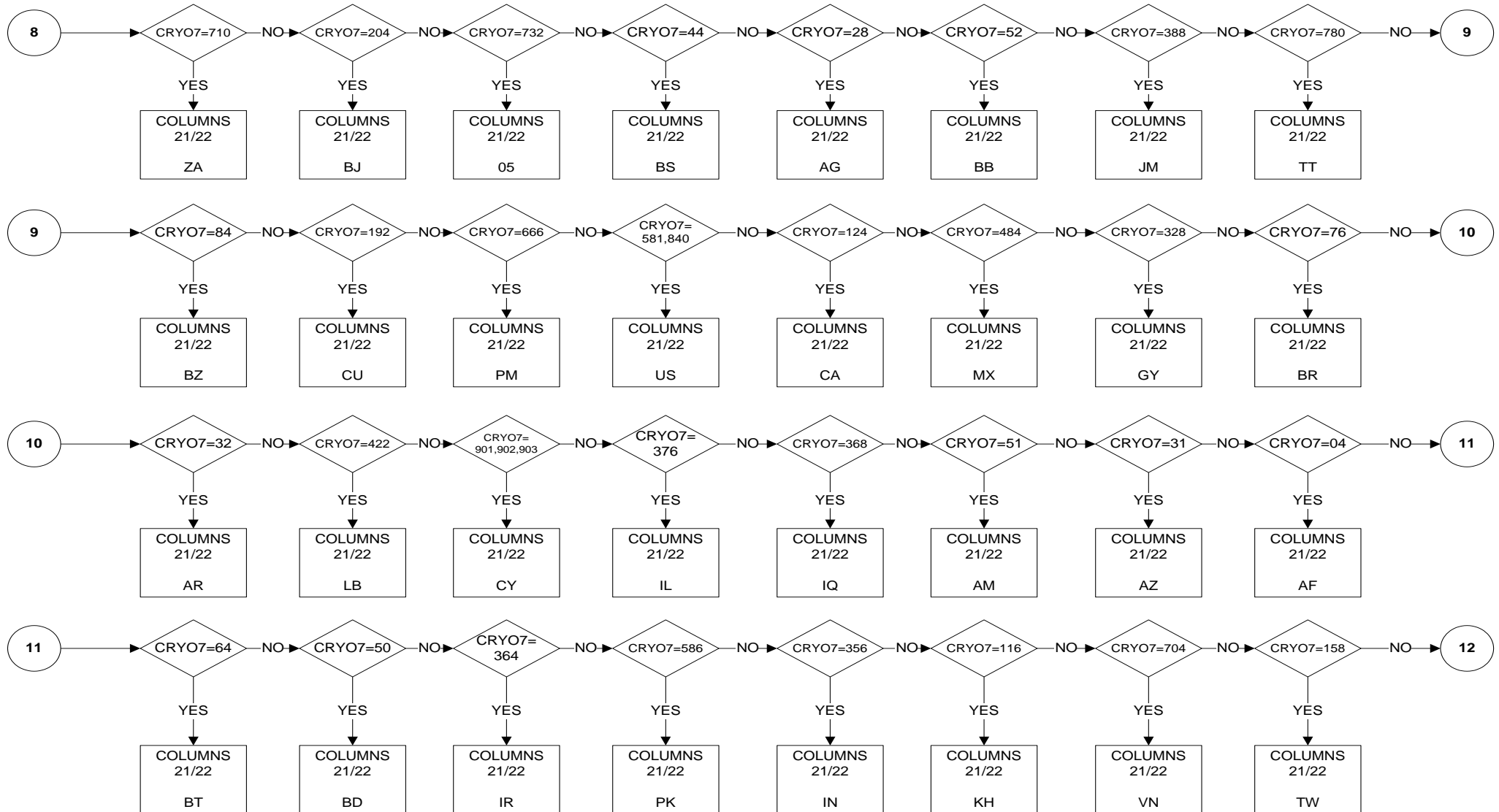

COUNTRYB (ECOB): Country of Birth

Columns 21/22

PAGE 4 OF 7

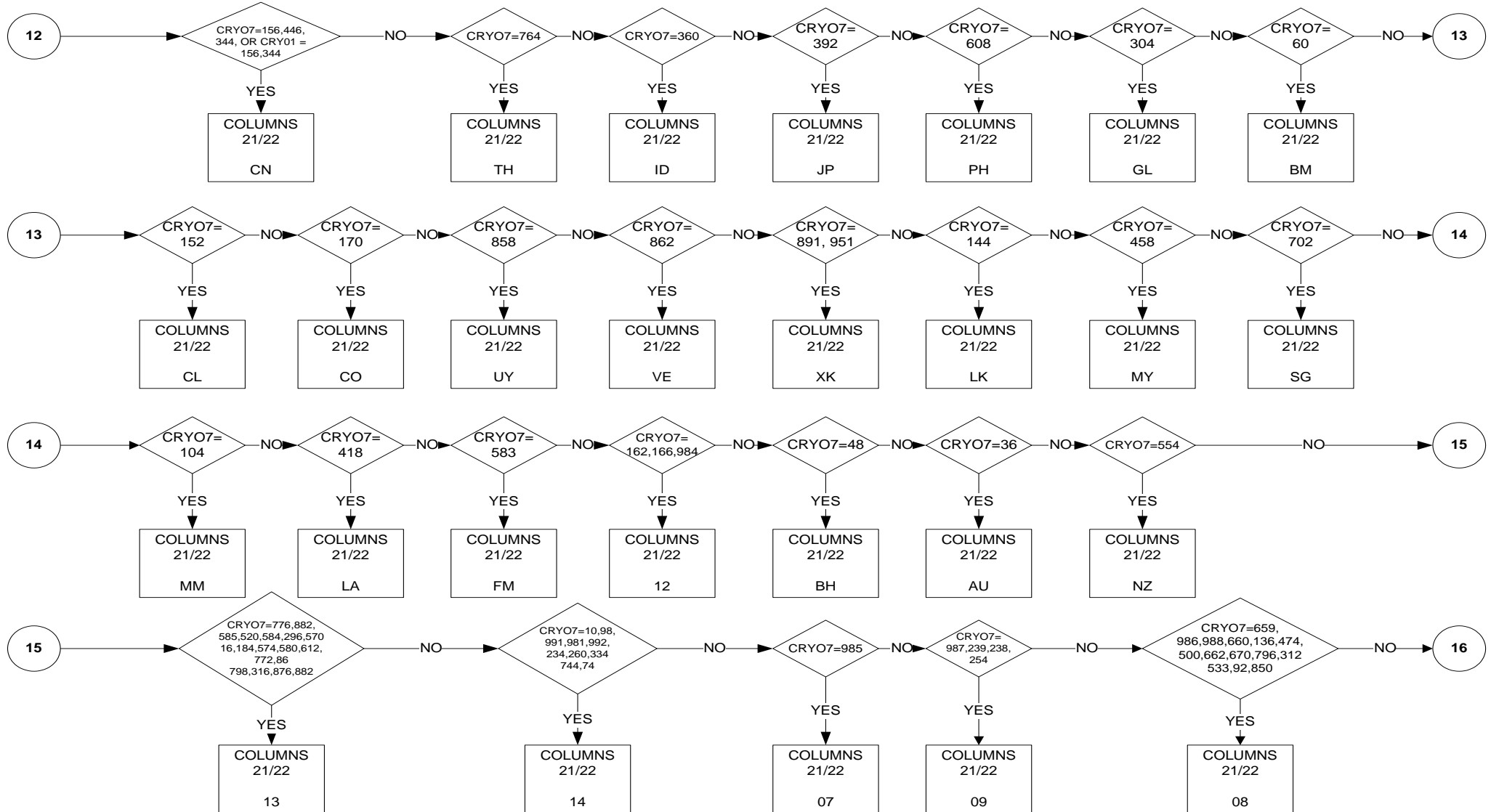

COUNTRYB (ECOB): Country of Birth

Columns 21/22

PAGE 5 OF 7

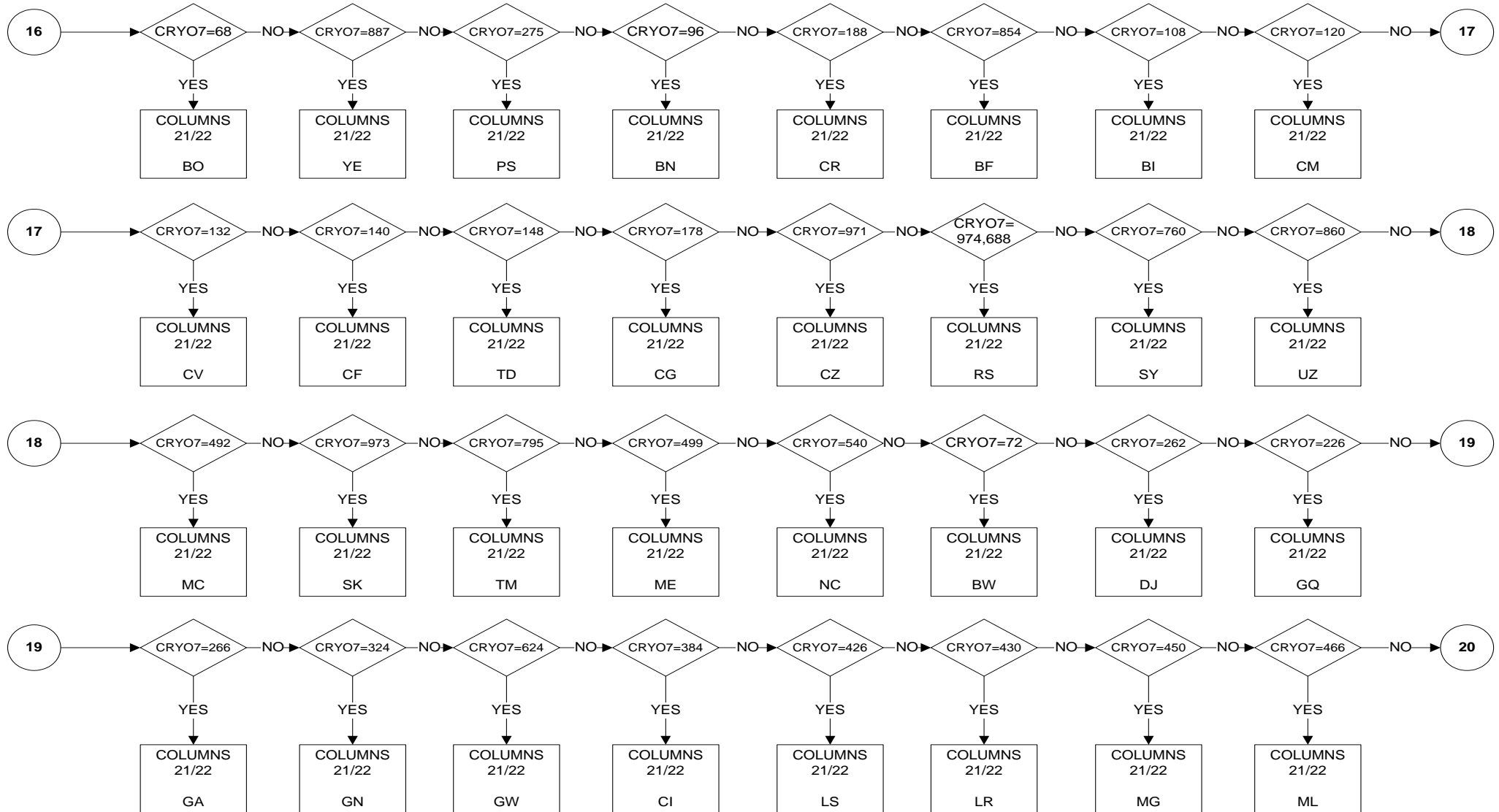

COUNTRYB (ECOB): Country of Birth

Columns 21/22

PAGE 6 OF 7

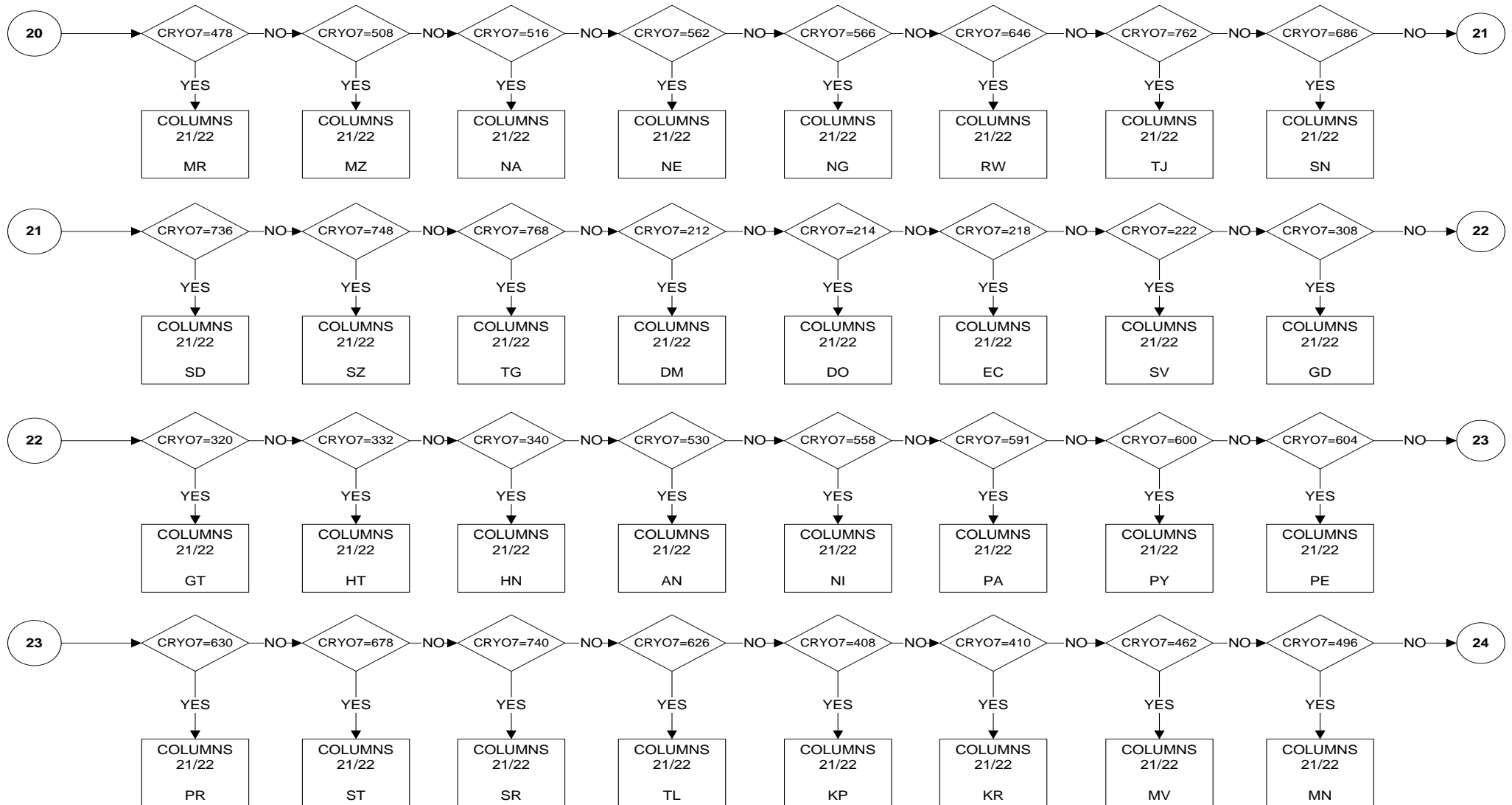

COUNTRYB (ECOB): Country of Birth

Columns 21/22

PAGE 7 OF 7

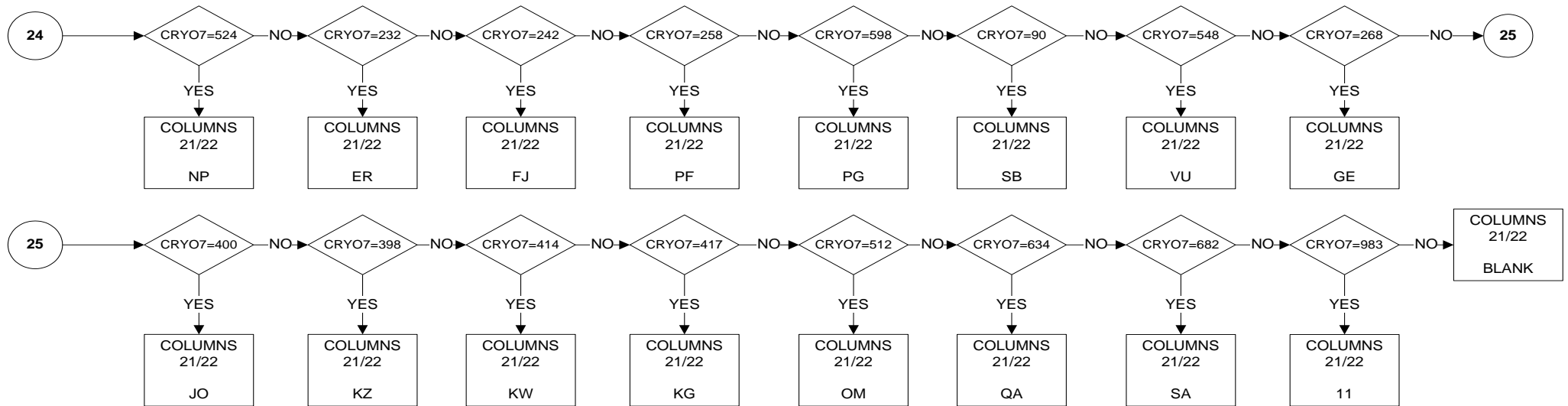

KEY

99 Not Applicable (Col 19/20 = 00)
 BLANK No Answer

Notes

For coding, see ISO country classification

PROXY (EPROXY): Nature of participation in survey

Column 23
PAGE 1 OF 1

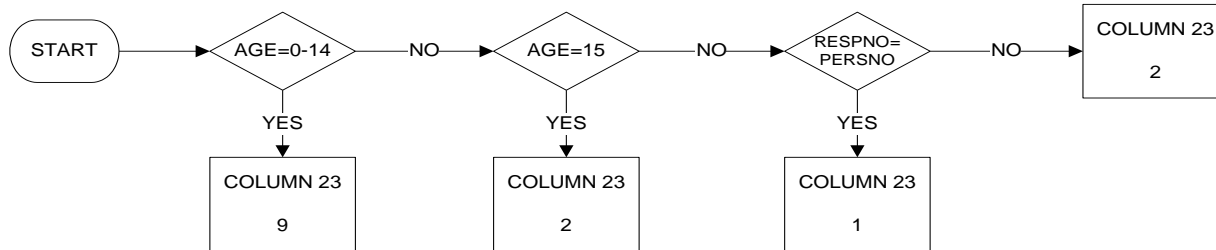

KEY	
1	Direct participation
2	Participation via another member of the household
9	Not applicable (child less than 15 years old)
BLANK	No answer

WSTATOR (EWKSTATR): Labour status during the reference week

Column 24
PAGE 1 OF 2

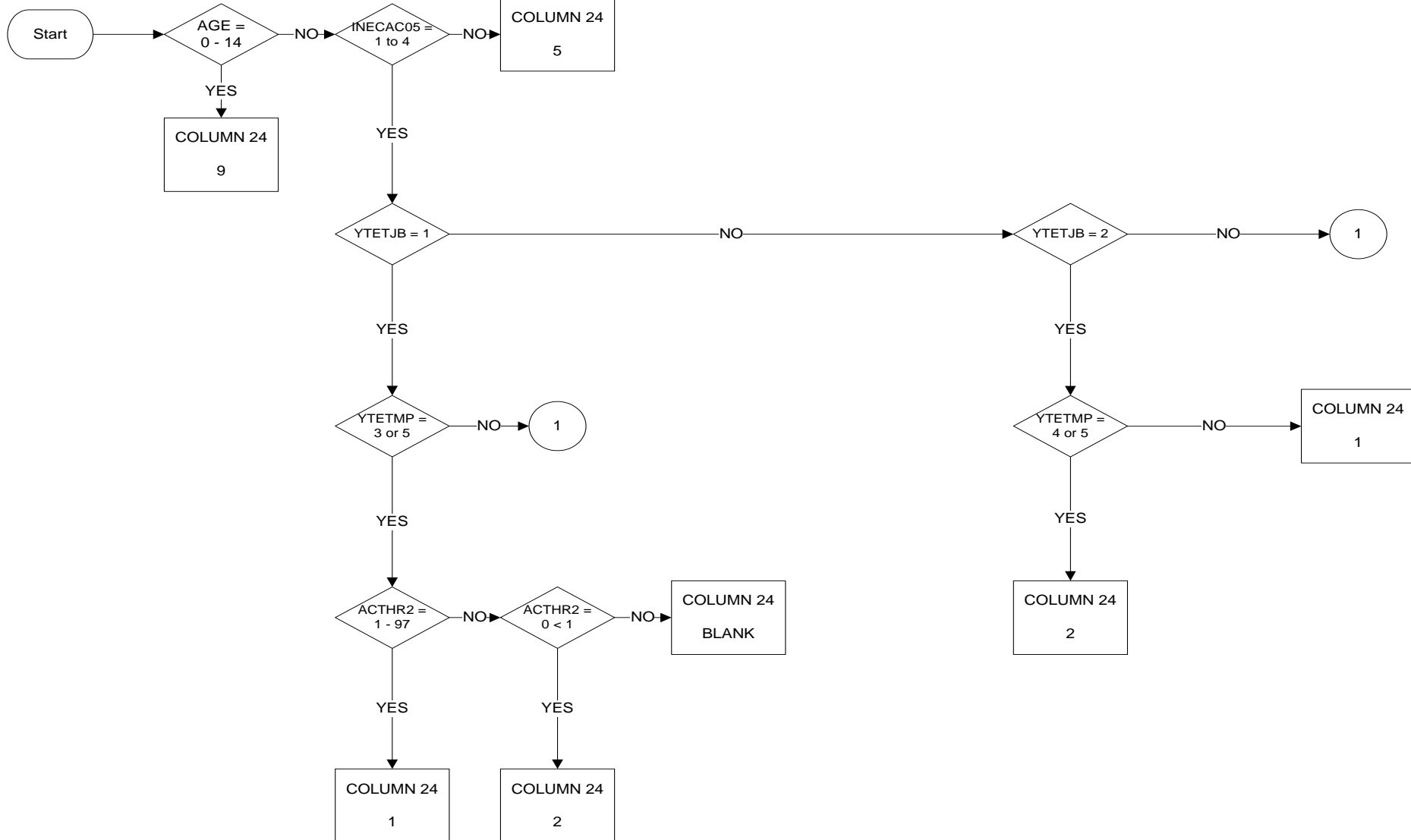

WSTATOR (EWKSTATR): Labour status during the reference week

Column 24

PAGE 2 OF 2

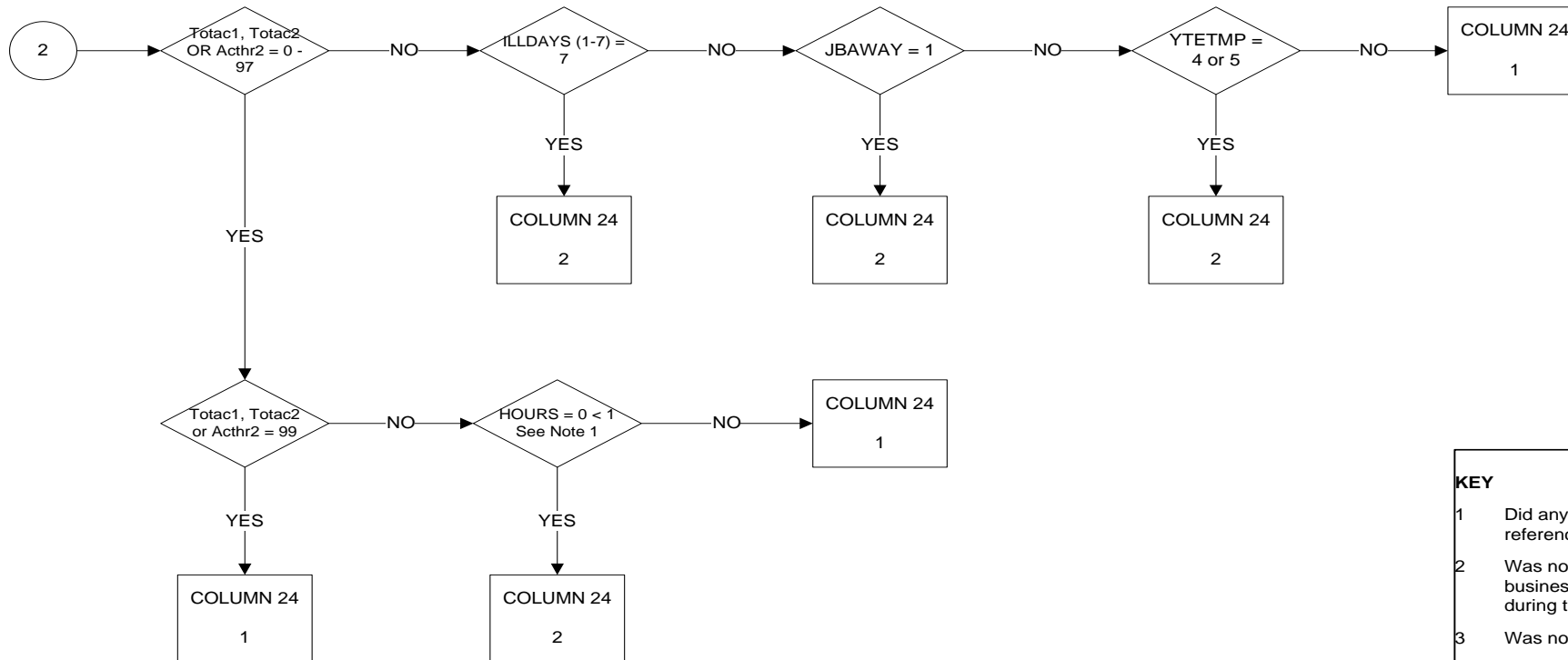

KEY

- 1 Did any work for pay or profit during the reference week - one hour or more
- 2 Was not working but had a job or business from which he/she was absent during the reference week
- 3 Was not working because on lay-off
- 4 Was a conscript on compulsory military or community service
- 5 Other (15 years or more) who neither worked nor had a job or business during the reference week
- 9 Not applicable (child less than 15 years old)

Note 1:

(TOTAC1 (if TOTAC1 >=0 and <= 97) +
(TOTAC2 (if TOTAC2 >=0 and <= 97) +
(ACTHR2 (if ACTHR2 >=0 and <= 97) =

0 to less than 1

NOWKREAS (ERESAWYR): Reason for not having worked at all though having a job

Column 25/26

PAGE 1 OF 2

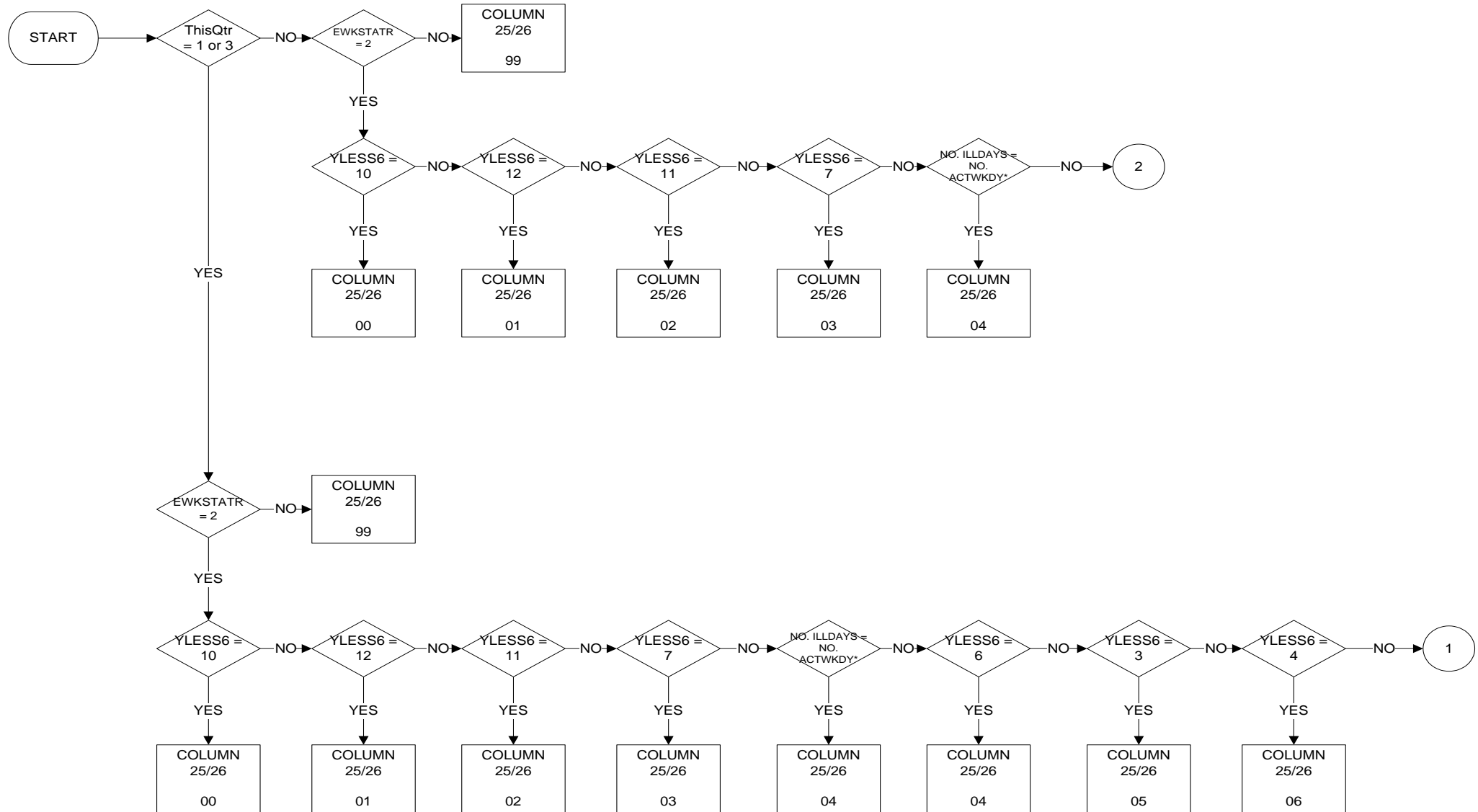

NOWKREAS (ERESAWYR): Reason for not having worked at all though having a job

Column 25/26

PAGE 2 OF 2

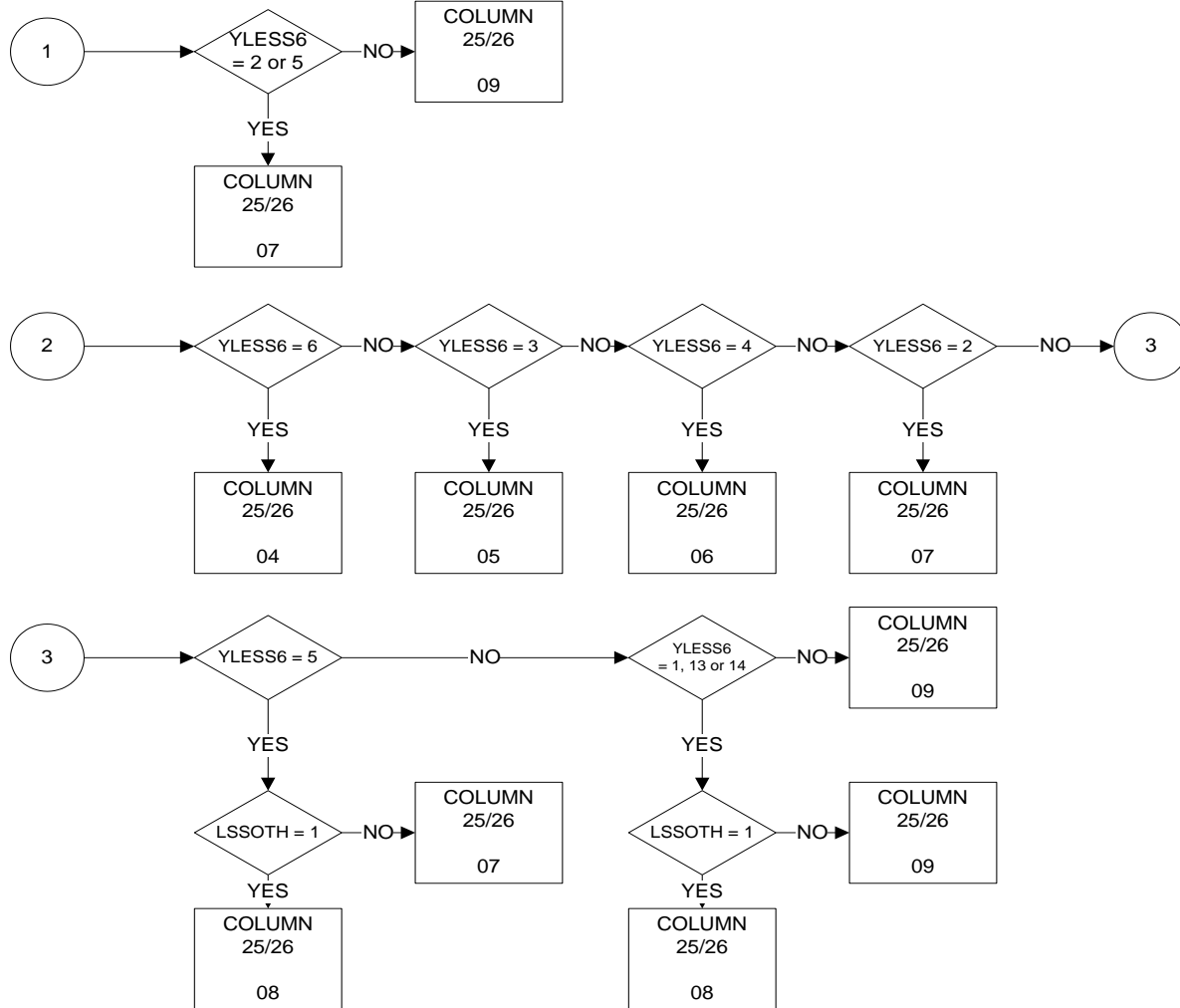

KEY

- 00 Bad weather
- 01 Slack work for technical or economic reasons
- 02 Labour dispute
- 03 School education or training
- 04 Own illness, injury or temporary disability
- 05 Maternity leave
- 06 Parental leave
- 07 Holidays
- 08 Compensation leave (within the framework of working time banking or an annualised hours contract)
- 09 Other reasons (e.g. personal or family responsibilities)
- 99 Not applicable (WSTATOR = 1, 3-5, 9)

Notes

LSSOTH asked in AJ and OD quarters only

* No. of positive replies in ILLDAYS(1-7) and ACTWKDY(1-7), and illdays > 0

STAPRO (ESTATR): Professional status

Column 27
PAGE 1 OF 1

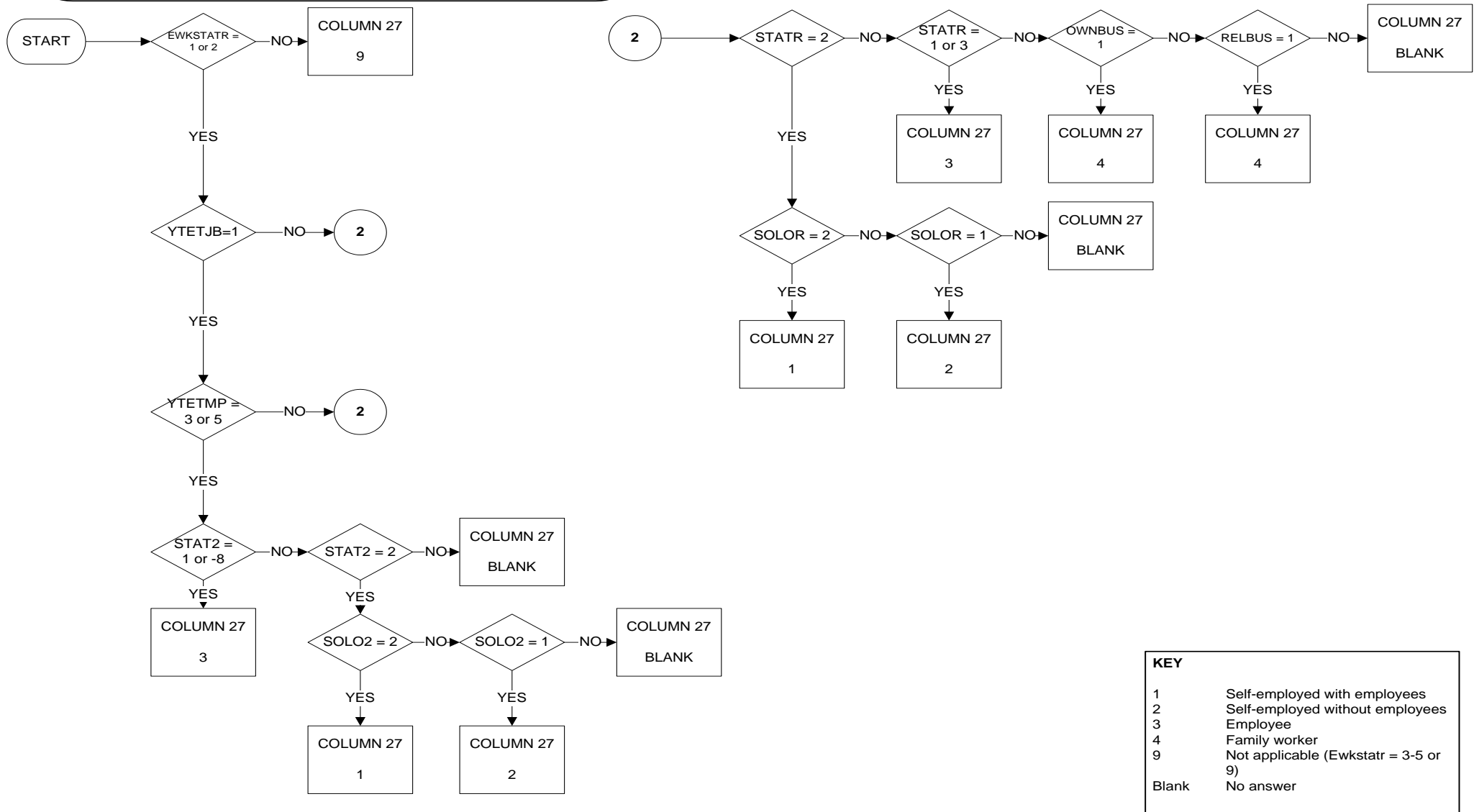

KEY	
1	Self-employed with employees
2	Self-employed without employees
3	Employee
4	Family worker
9	Not applicable (Ewkstatr = 3-5 or 9)
Blank	No answer

SIGNALSAL (EFISAL): Continuing receipt of wage or salary

Column 28
PAGE 1 OF 1

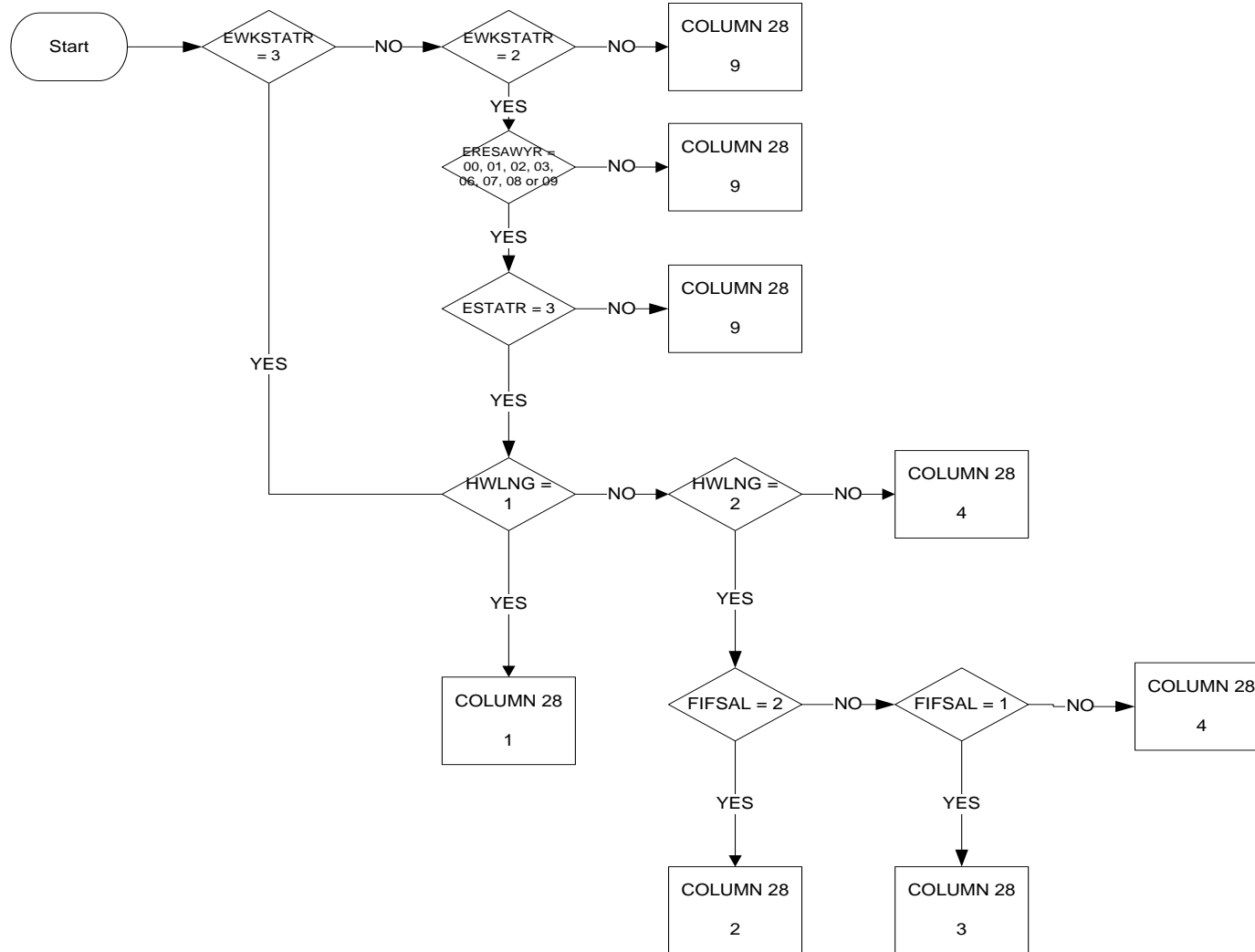

KEY

- 1 Absent for up to and including 3 months
- 2 Absent for more than 3 months and receiving a wage, salary or social allowances corresponding to half or more of the salary
- 3 Absent for more than 3 months and receiving a wage, salary or social allowances corresponding to less than half of the salary
- 4 Don't know
- 9 Not applicable (WSTATOR ? 2 or NOWKREAS = 04 or NOWKREAS = 05 or STAPRO ? 3) and WSTATOR ? 3)

NACE3D (ENACE08): Economic activity of the local unit

Column 29/31

PAGE 1 OF 1

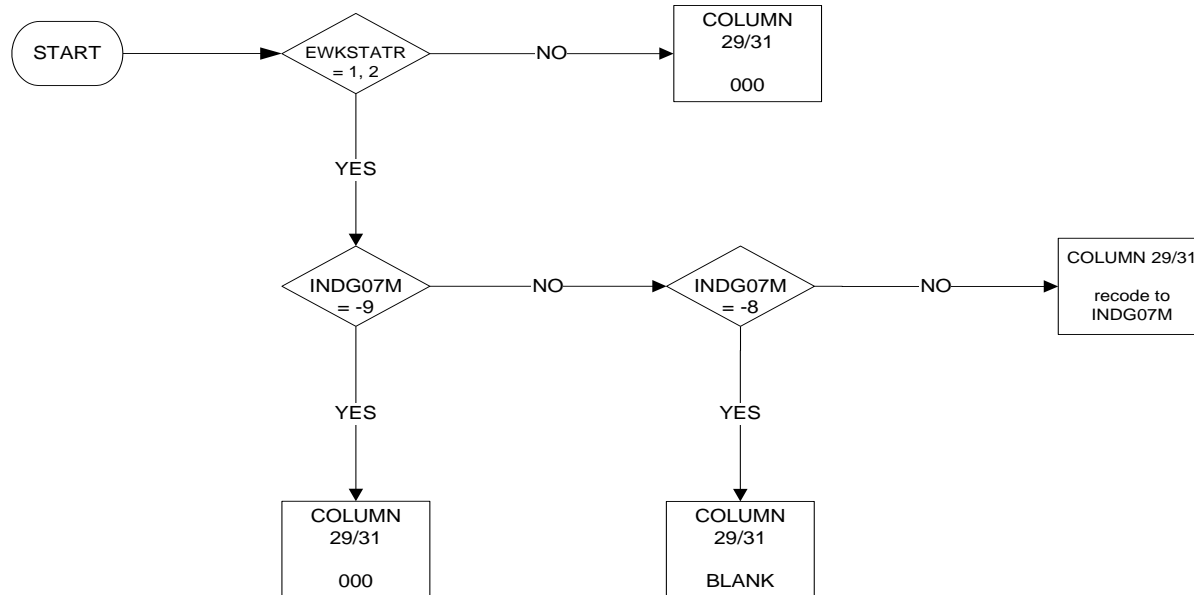

KEY

NACE Rev. 2 coded at 2 or if possible 3 digit level

000 Not applicable (WSTATOR = 3-5, 9)

Blank No answer

ISCO4D (EISCOMR): Occupation

Columns 32/35

PAGE 1 OF 3

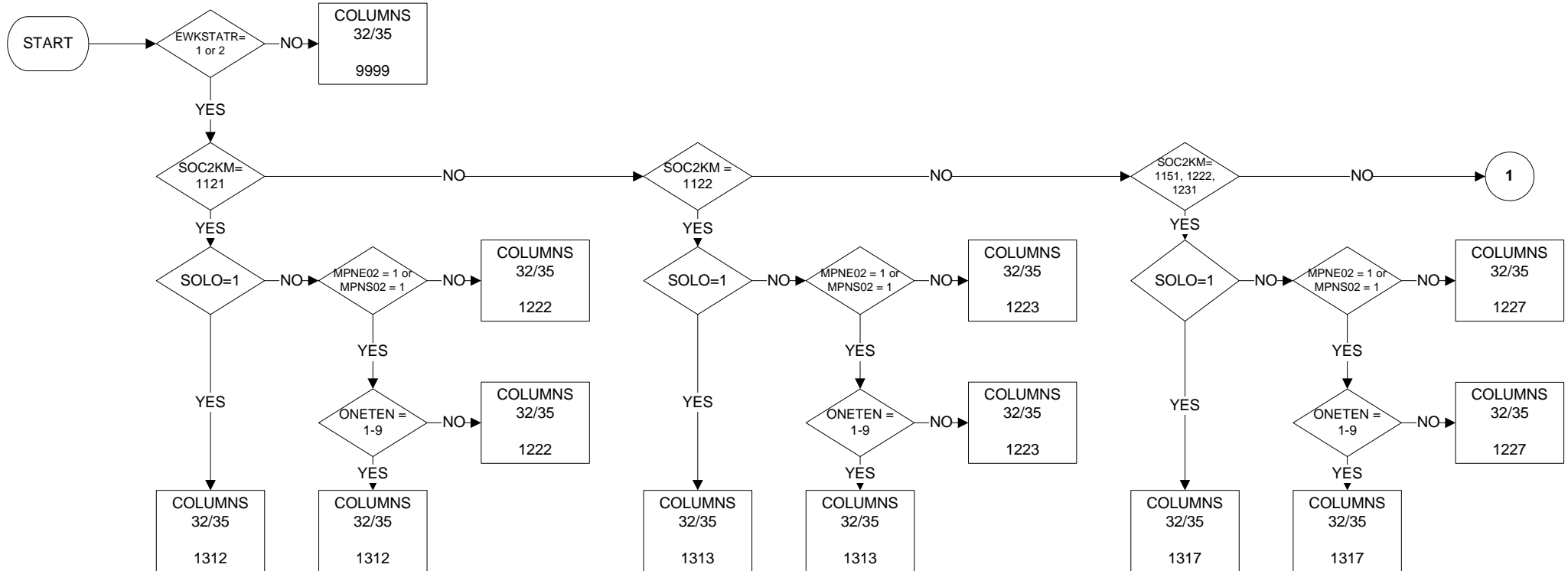

ISCO4D (EISCOMR): Occupation

Columns 32/35

PAGE 2 OF 3

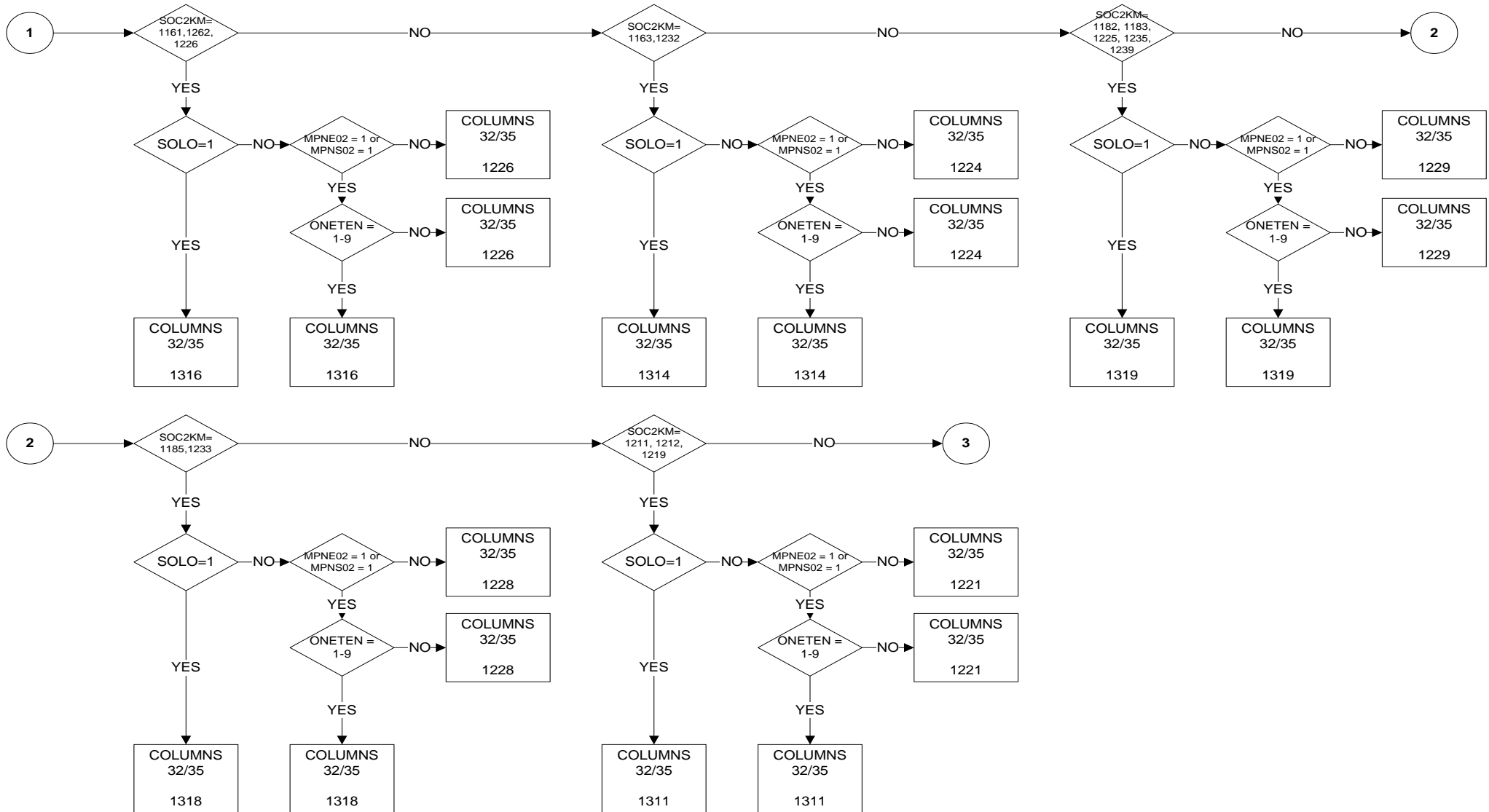

ISCO4D (EISCOMR): Occupation

Columns 32/35

PAGE 3 OF 3

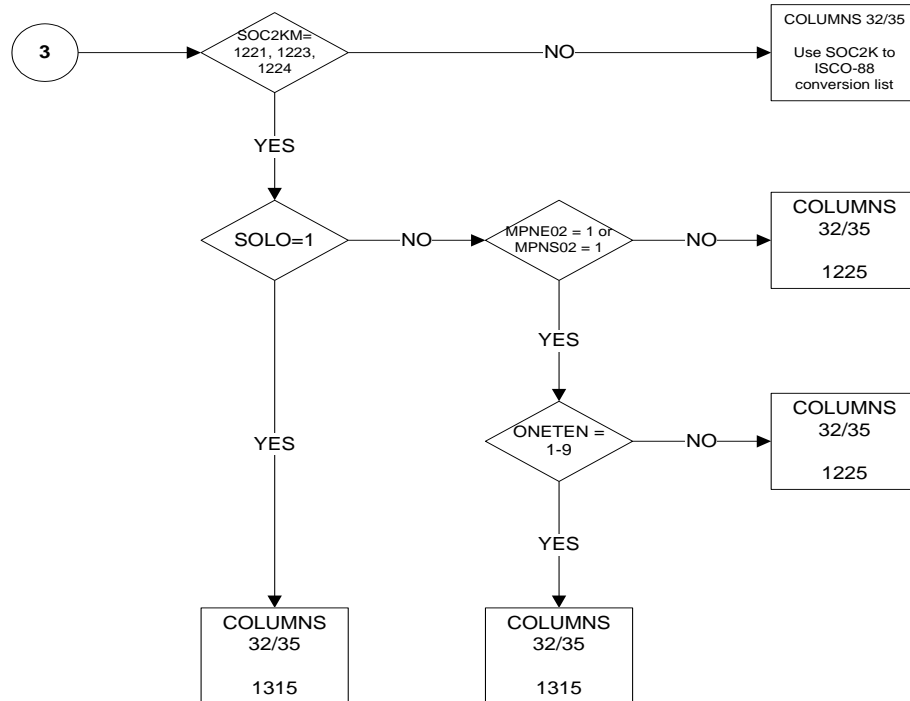

KEY

9999 Not applicable (WSTATOR = 3-5,9)
 blank No answer

Notes

ISCO-88 (COM) coded at 3 or if possible 4 digit level

The questionnaire variables SOLO and MPNE/MPNS can be used as EWKSTATR filters for current job only.

SUPVISOR (ESUPVIS): Supervisory responsibilities

Column 36

PAGE 1 OF 1

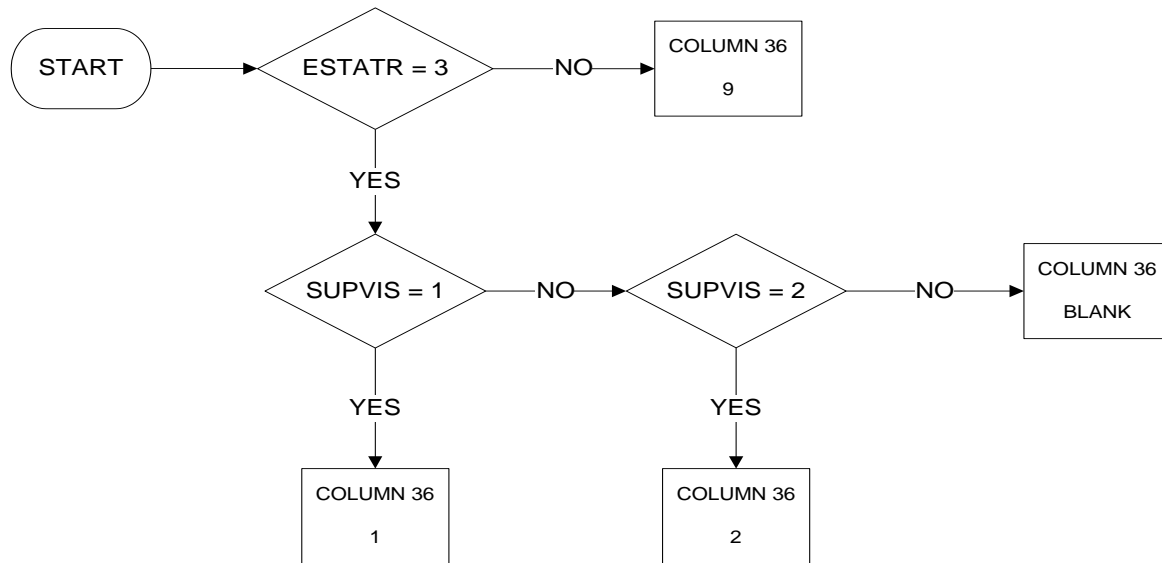

KEY	
1	Yes
2	No
9	STAPRO is not equal to 3
blank	No answer

SIZEFIRM (ENUMPR): Number of persons working at the local unit
 Columns 37/38
 PAGE 1 OF 1

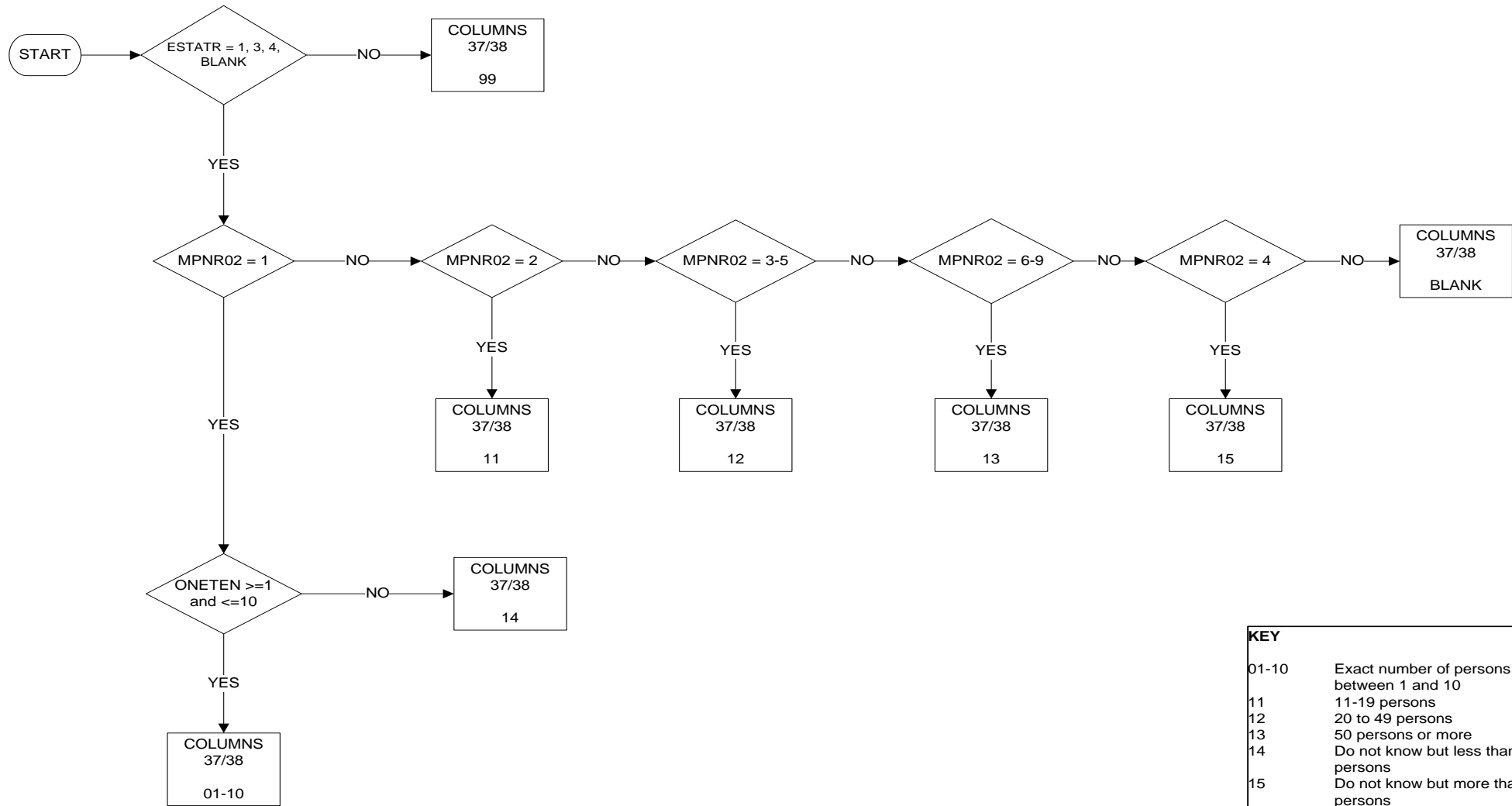

KEY	
01-10	Exact number of persons, if between 1 and 10
11	11-19 persons
12	20 to 49 persons
13	50 persons or more
14	Do not know but less than 11 persons
15	Do not know but more than 10 persons
99	Not applicable (ESTATR = 2,9)
Blank	No answer

COUNTRYW (ECONWRK): Country of place of work

Columns 39/40

PAGE 1 OF 7

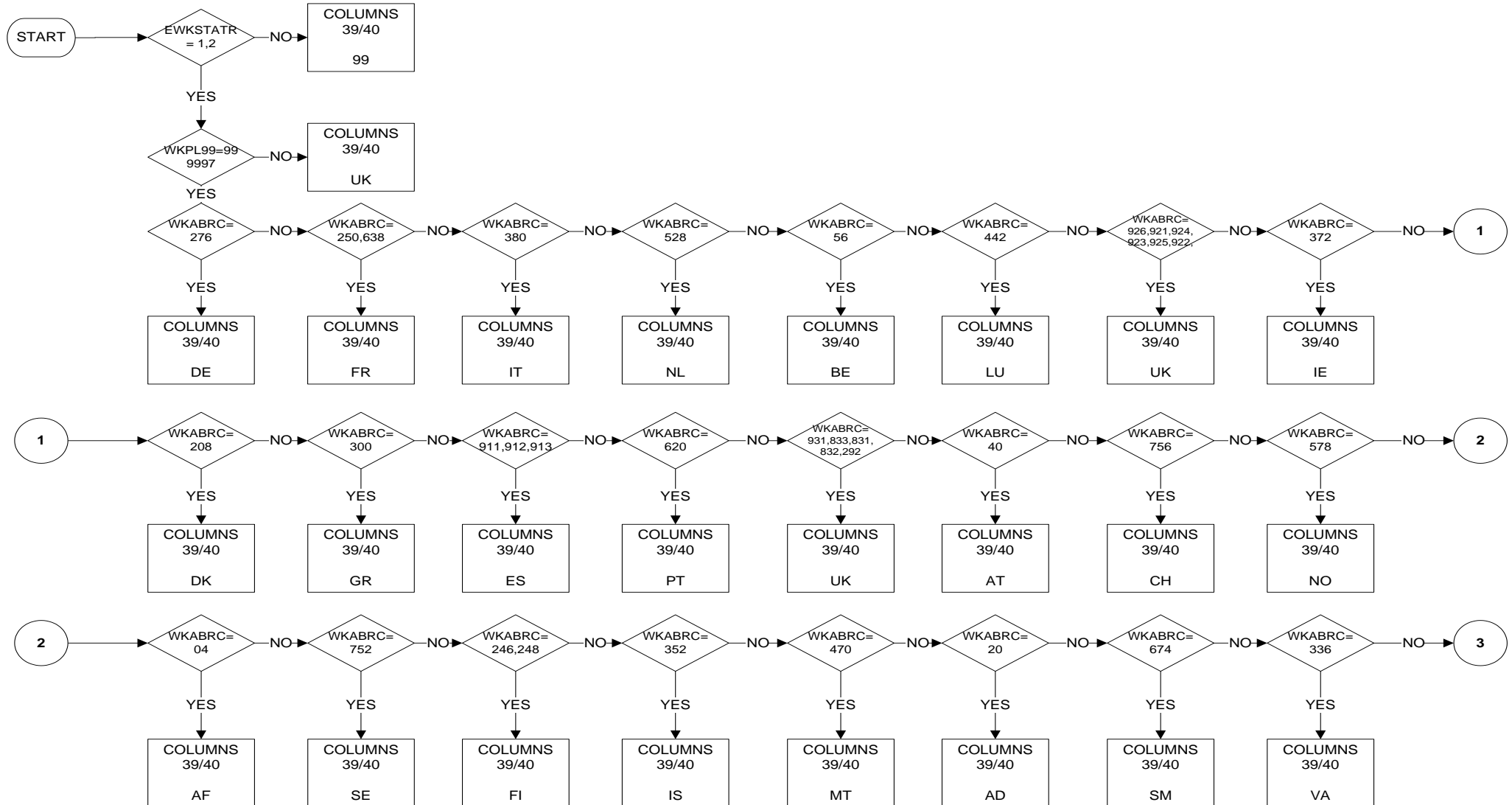

COUNTRYW (ECONWRK): Country of place of work

Columns 39/40

PAGE 2 OF 7

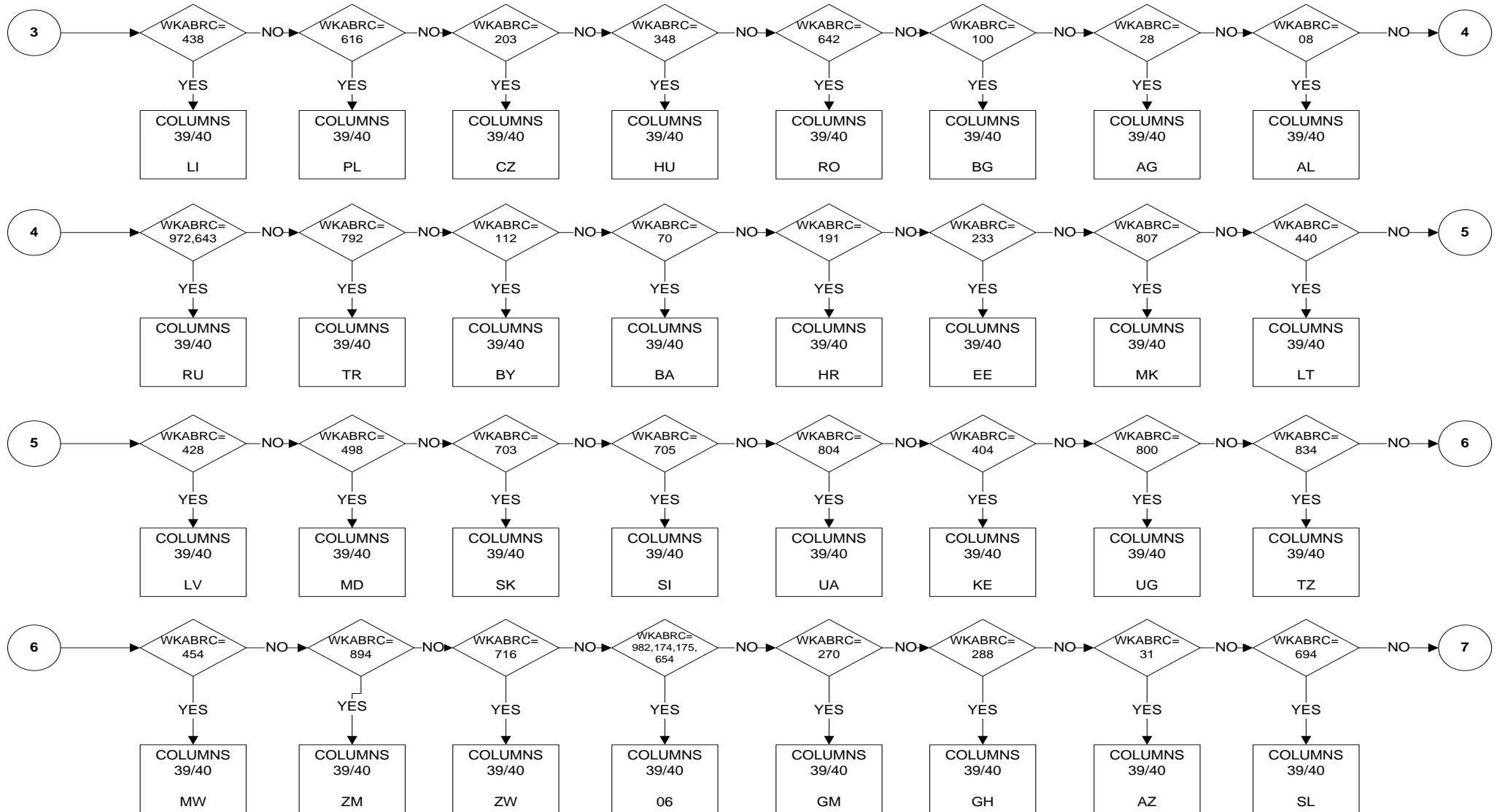

COUNTRYW (ECONWRK): Country of place of work

Columns 39/40

PAGE 3 OF 7

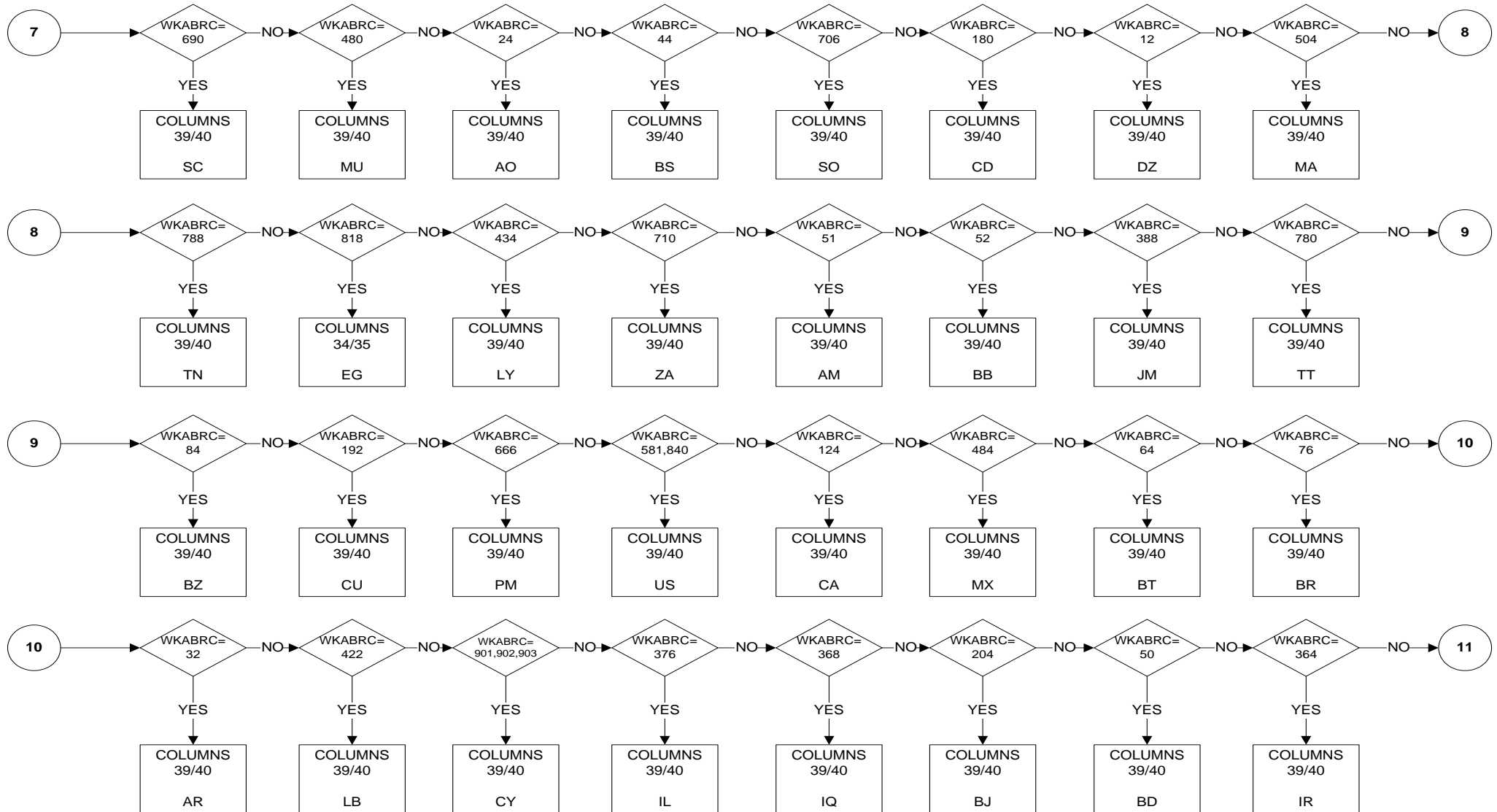

COUNTRYW (ECONWRK): Country of place of work

Columns 39/40

PAGE 4 OF 7

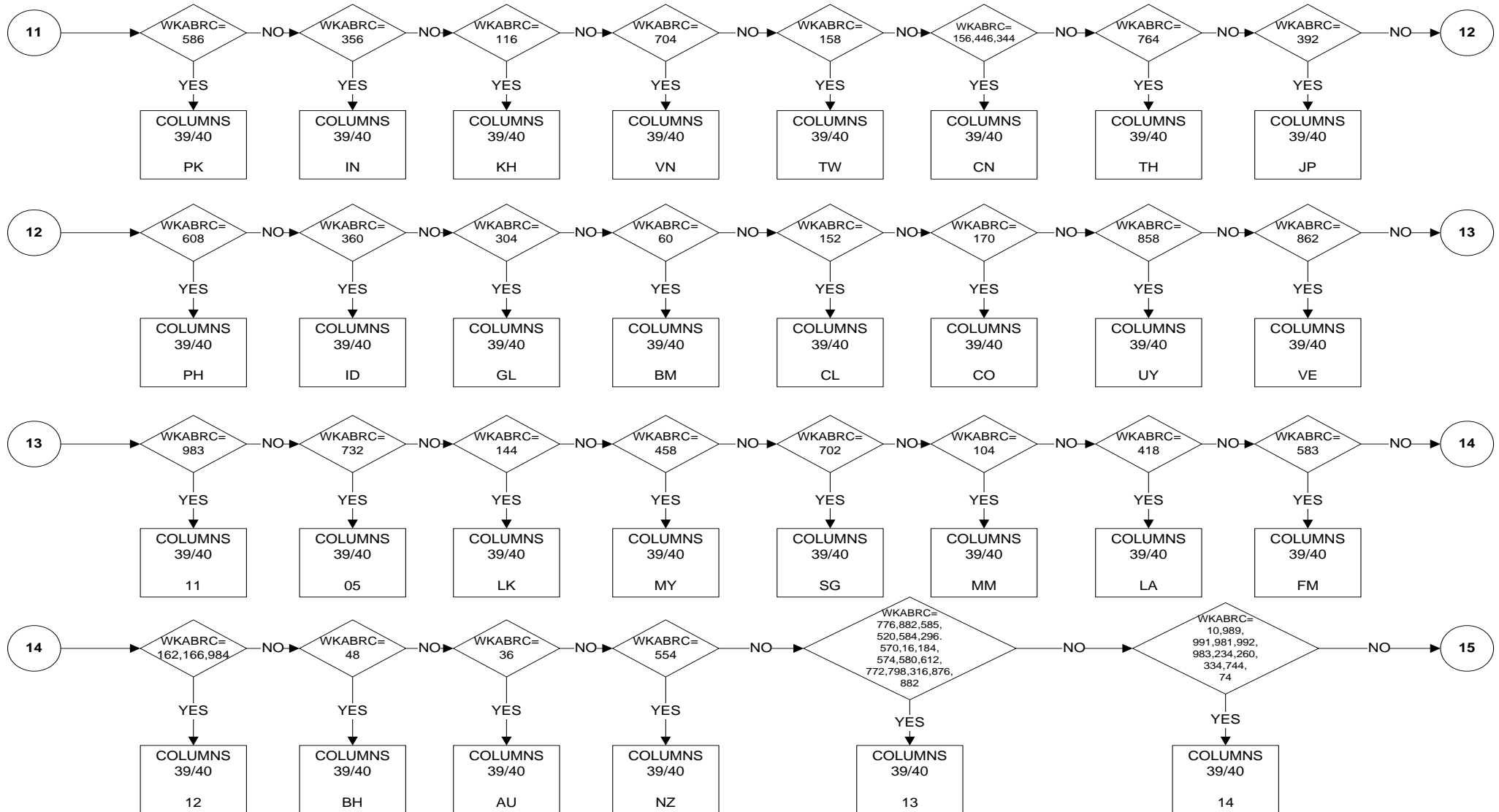

COUNTRYW (ECONWRK): Country of place of work

Columns 39/40

PAGE 5 OF 7

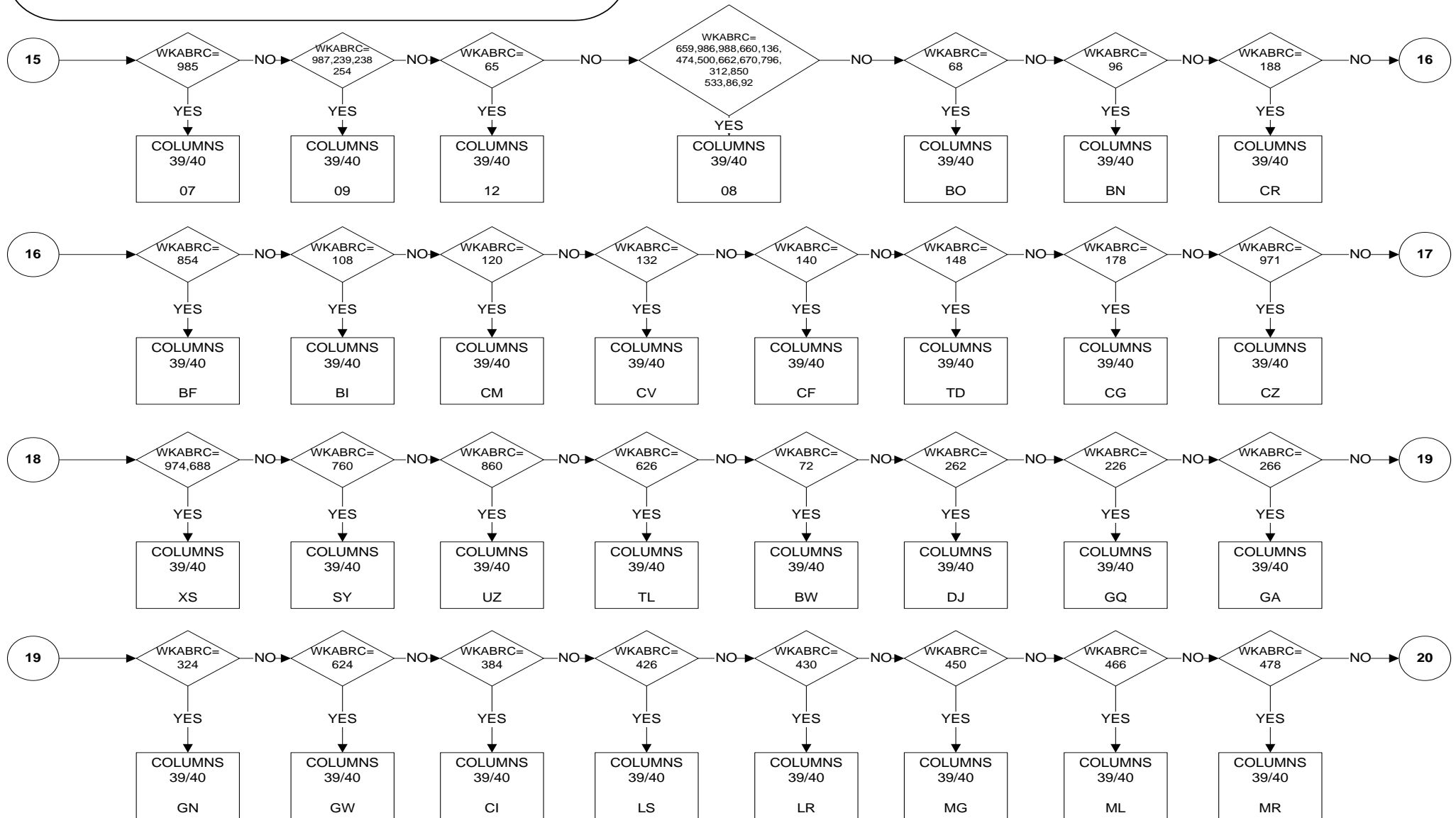

COUNTRYW (ECONWRK): Country of place of work

Columns 39/40

PAGE 6 OF 7

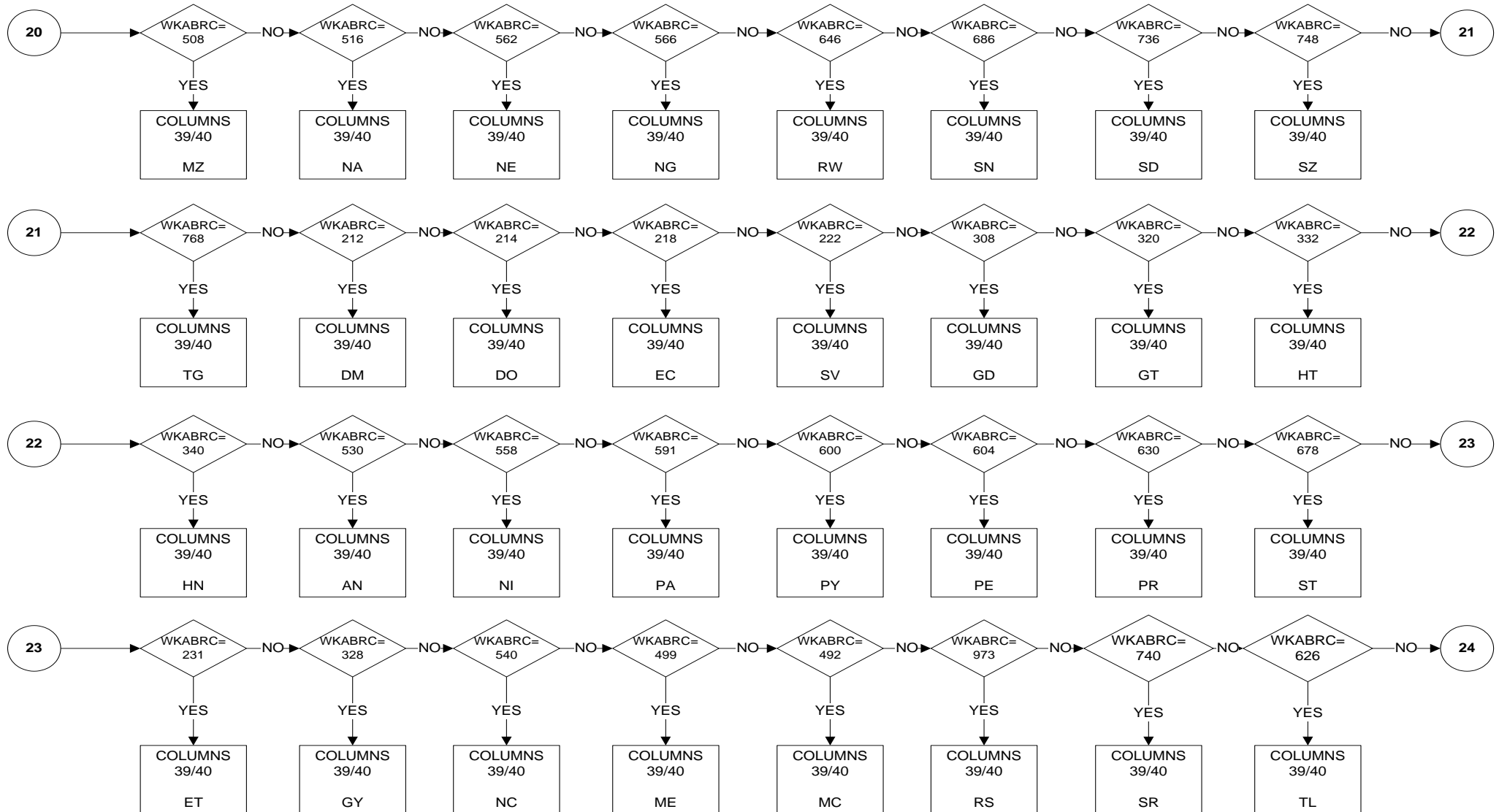

COUNTRYW (ECONWRK): Country of place of work

Columns 39/40

PAGE 7 OF 7

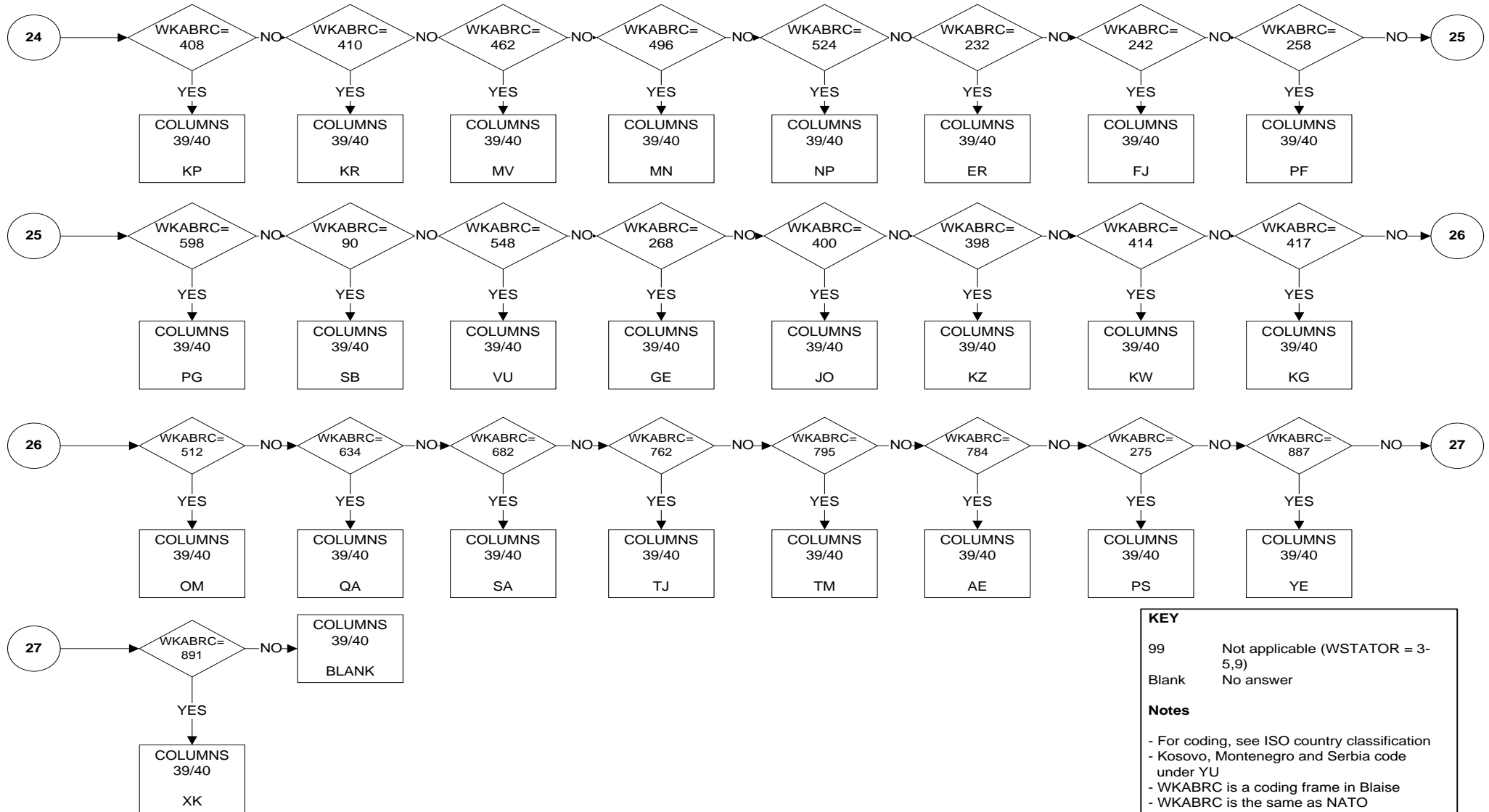

KEY

99 Not applicable (WSTATOR = 3-5,9)
Blank No answer

Notes

- For coding, see ISO country classification
- Kosovo, Montenegro and Serbia code under YU
- WKABRC is a coding frame in Blaise
- WKABRC is the same as NATO

REGIONW (EREGWKR): Region of place of work

Columns 41/42

PAGE 1 OF 5

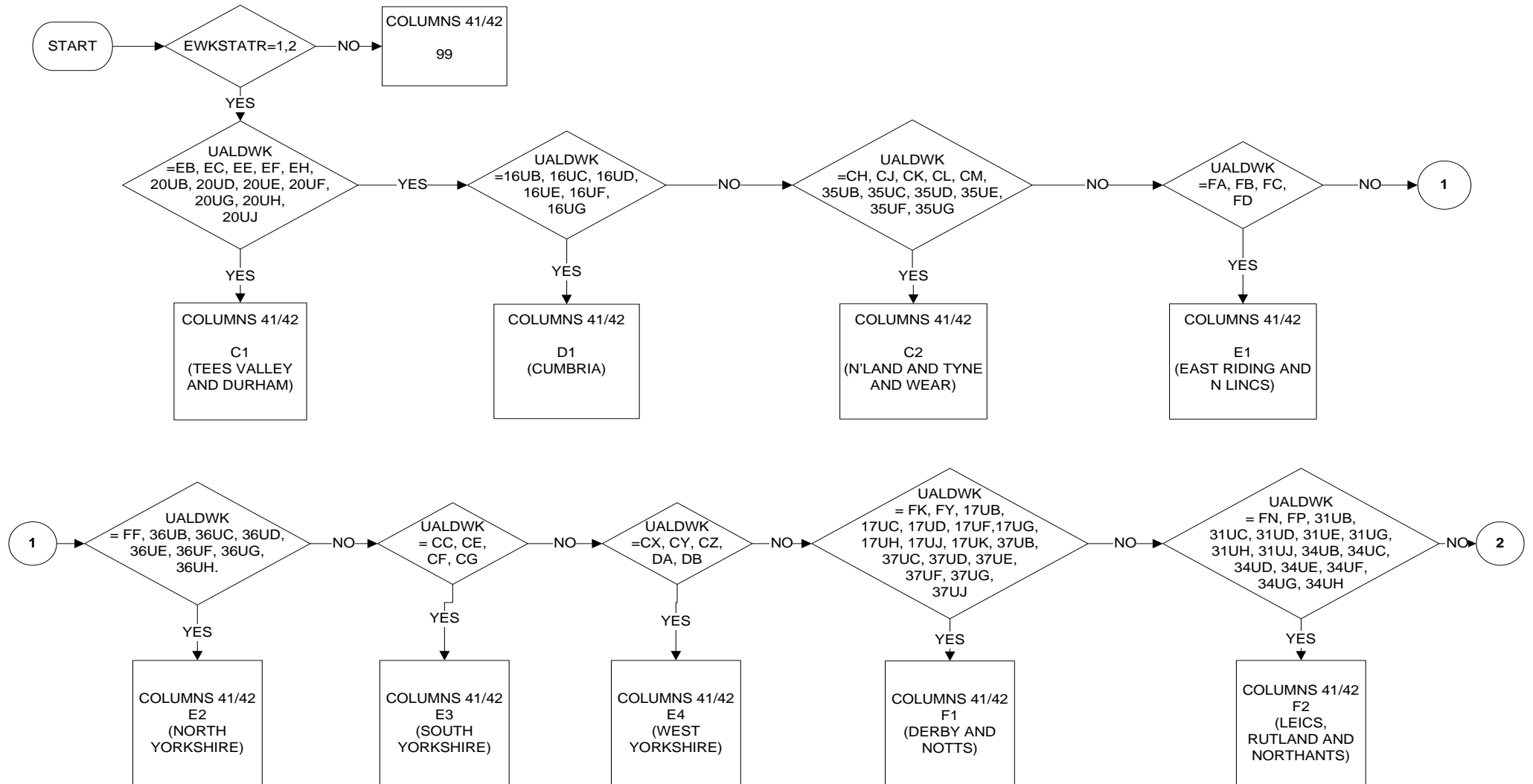

REGIONW (EREGWKR): Region of place of work

Columns 41/42

PAGE 2 OF 5

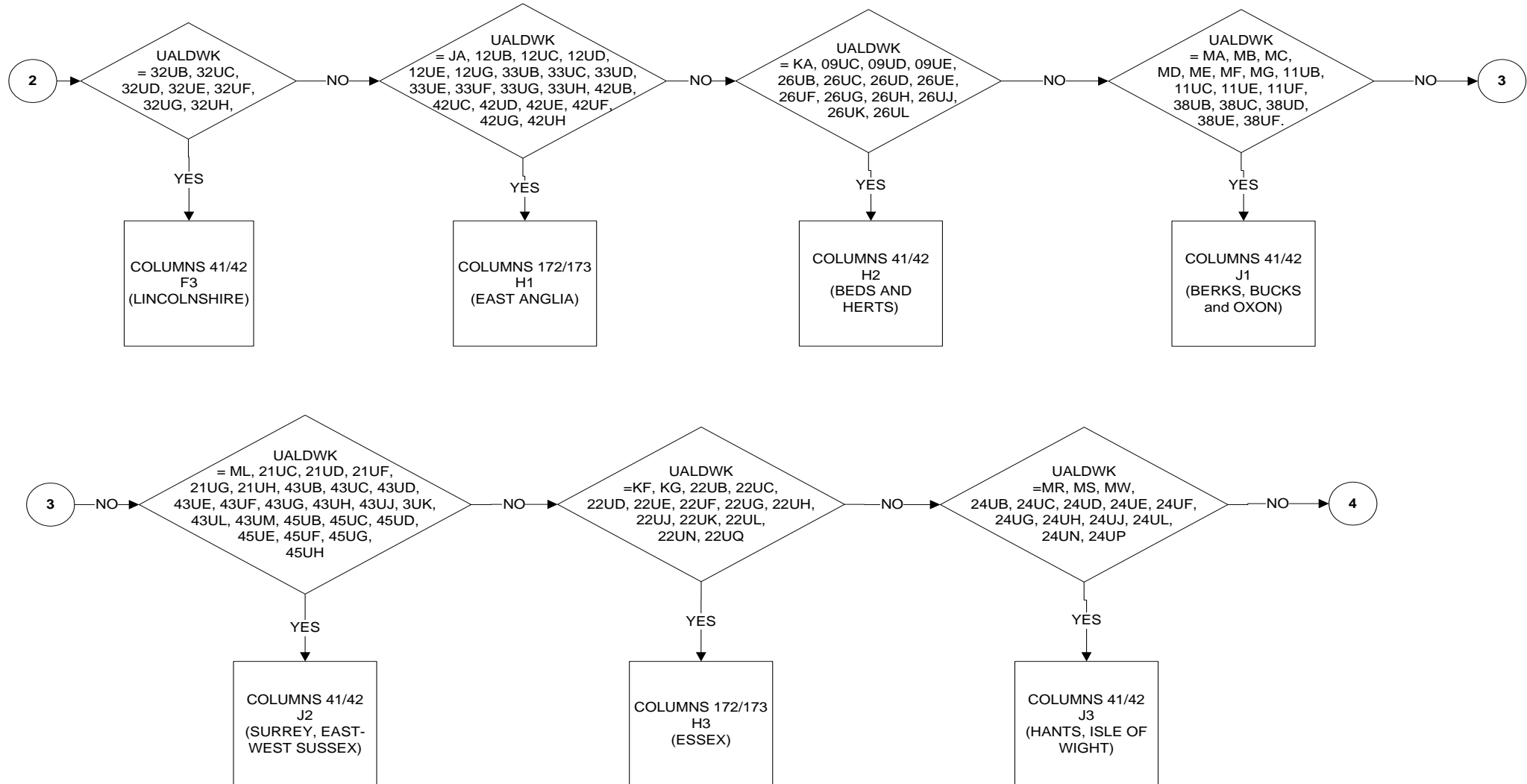

REGIONW (EREGWKR): Region of place of work

Columns 41/42

PAGE 3 OF 5

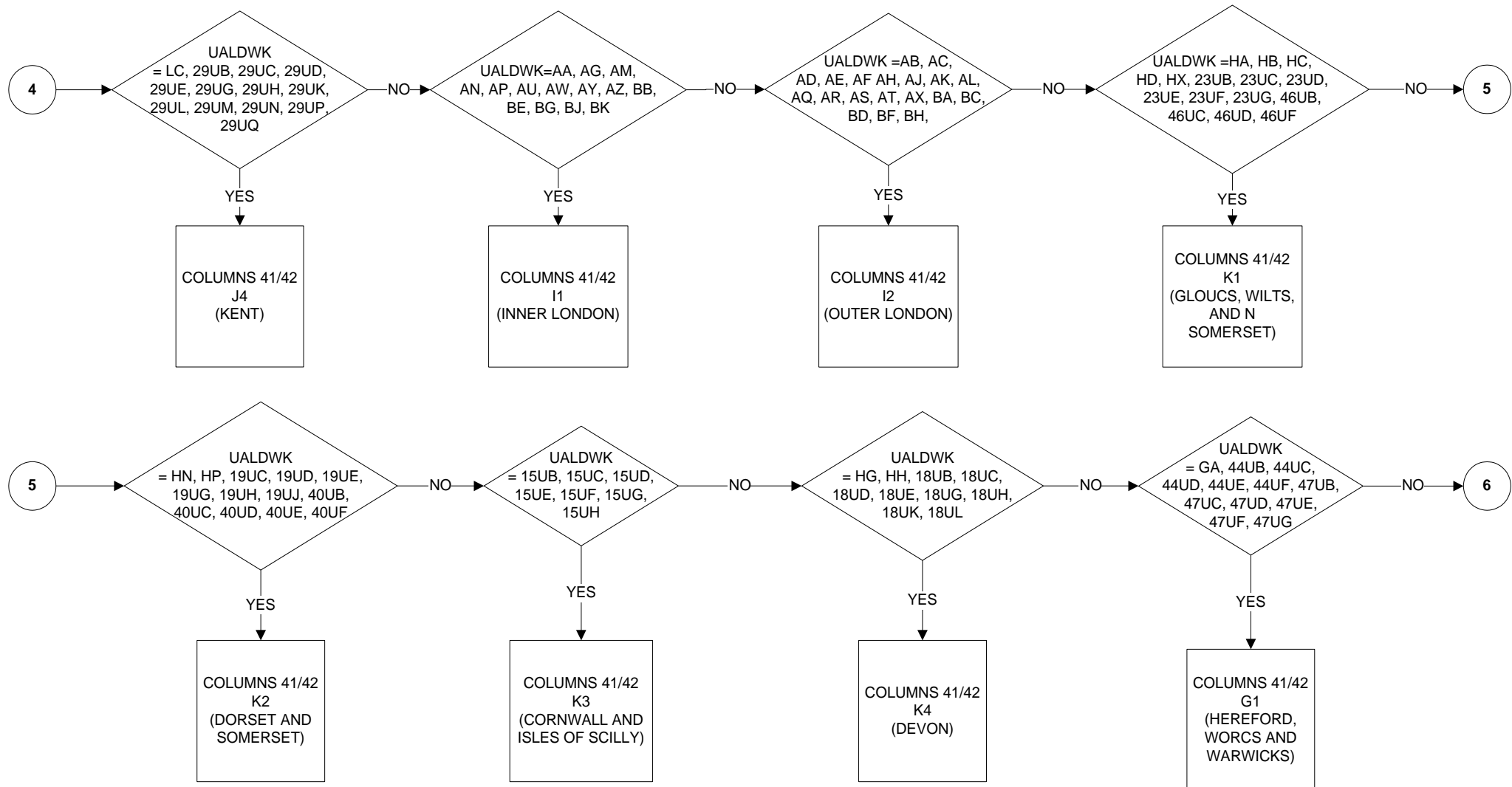

REGIONW (EREGWKR): Region of place of work

Columns 41/42

PAGE 4 OF 5

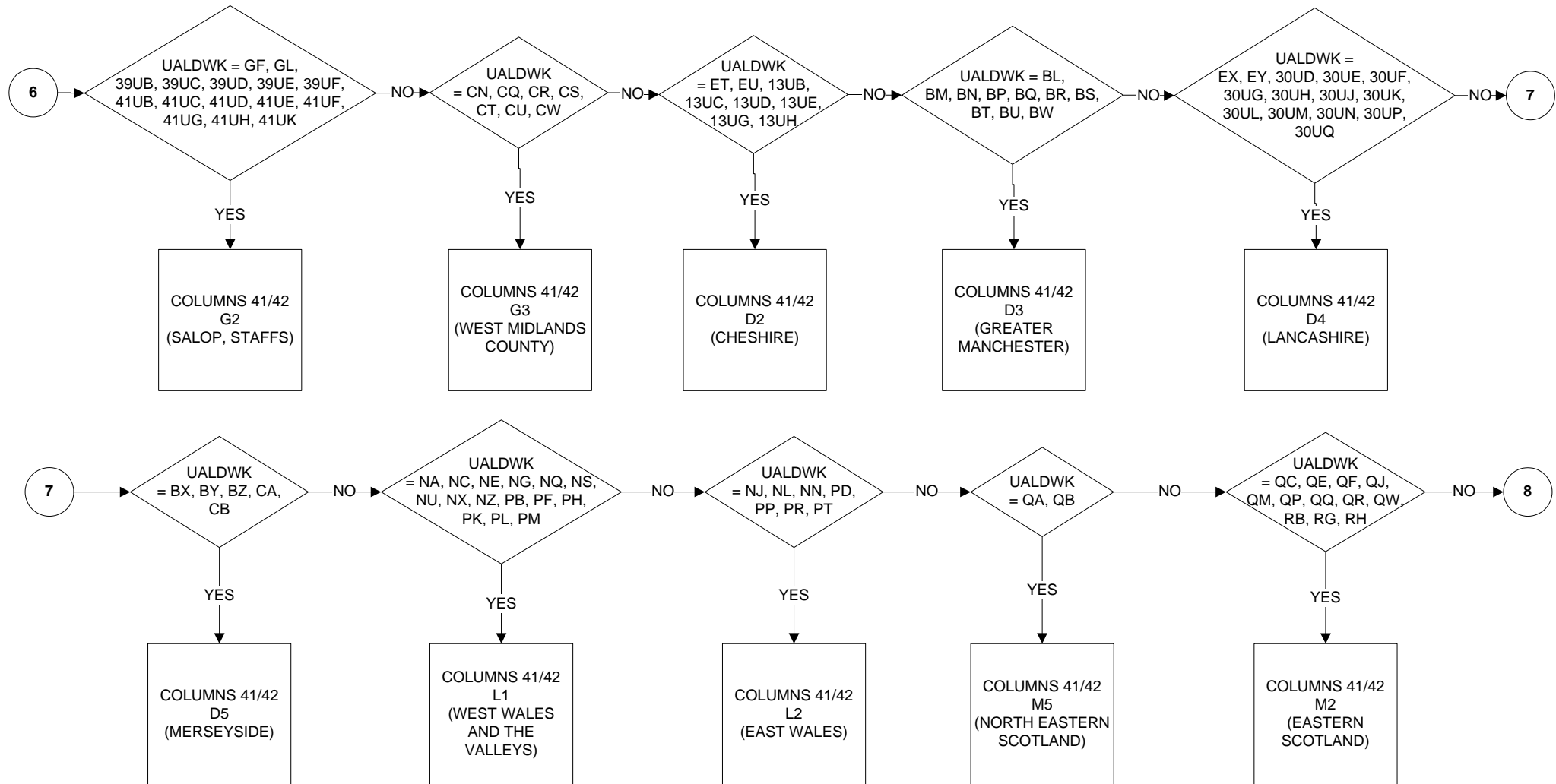

REGIONW (EREGWKR): Region of place of work

Columns 41/42

PAGE 5 OF 5

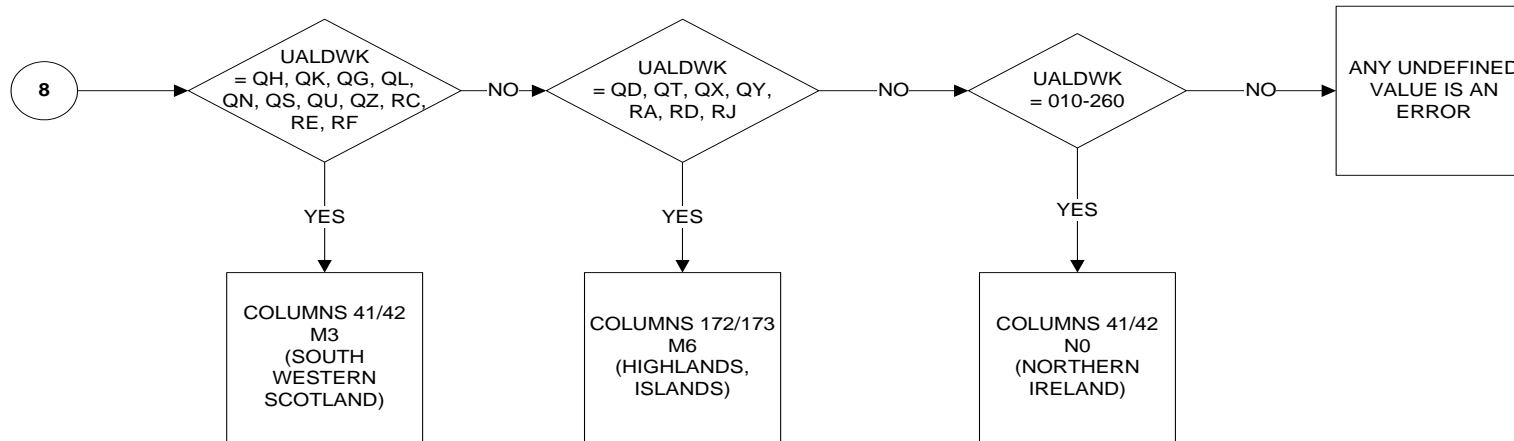

KEY	
99	Not applicable (WSTATOR = 3-5,9)
blank	No answer

YSTARTWK (EYRSTRTR): Year in which person started working for this employer or as self-employed

Columns 43/46

PAGE 1 OF 1

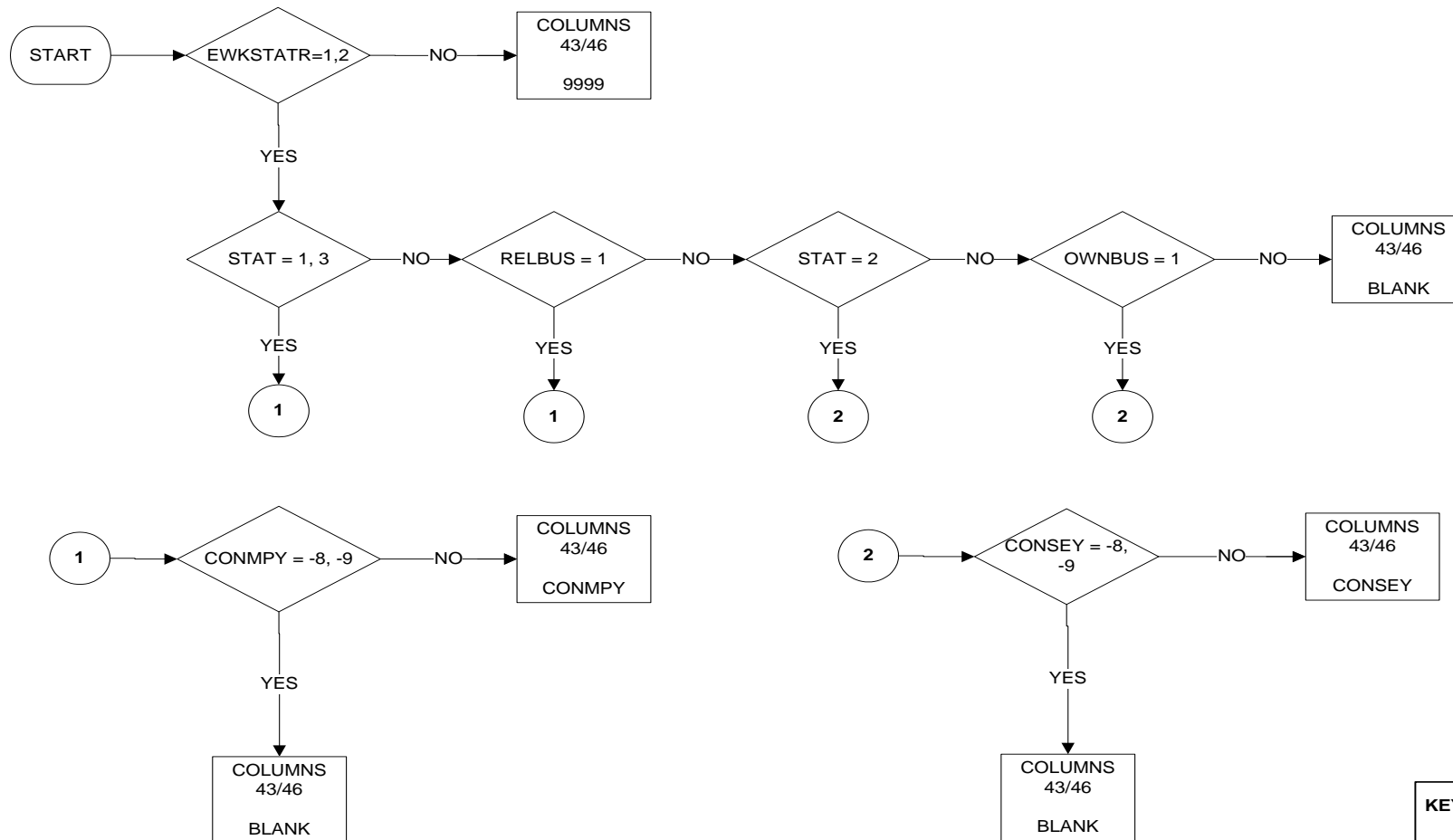

KEY	
	Enter the 4 digits of the year concerned
9999	Not applicable (WSTATOR = 3-5,9)
blank	No answer

MSTARTWK (EMNSTRTR): Month started with current employer/self-employed

Columns 47/48

PAGE 1 OF 1

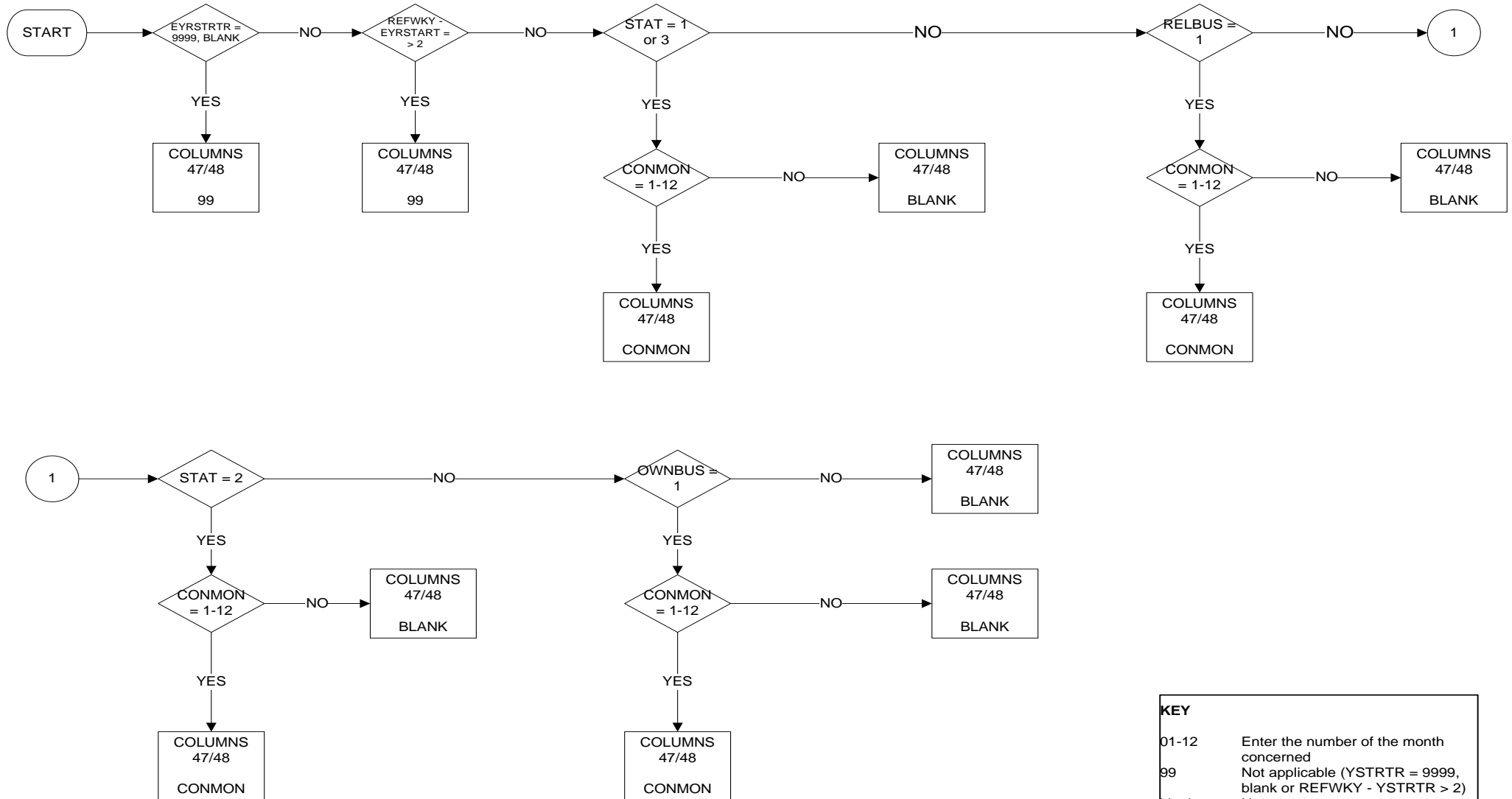

KEY	
01-12	Enter the number of the month concerned
99	Not applicable (YSTRTR = 9999, blank or REFWKY - YSTRTR > 2)
blank	No answer

WAYJFOUN (EHOWGET): Involvement of the public employment office at any moment in finding the present job

Column 49

PAGE 1 OF 1

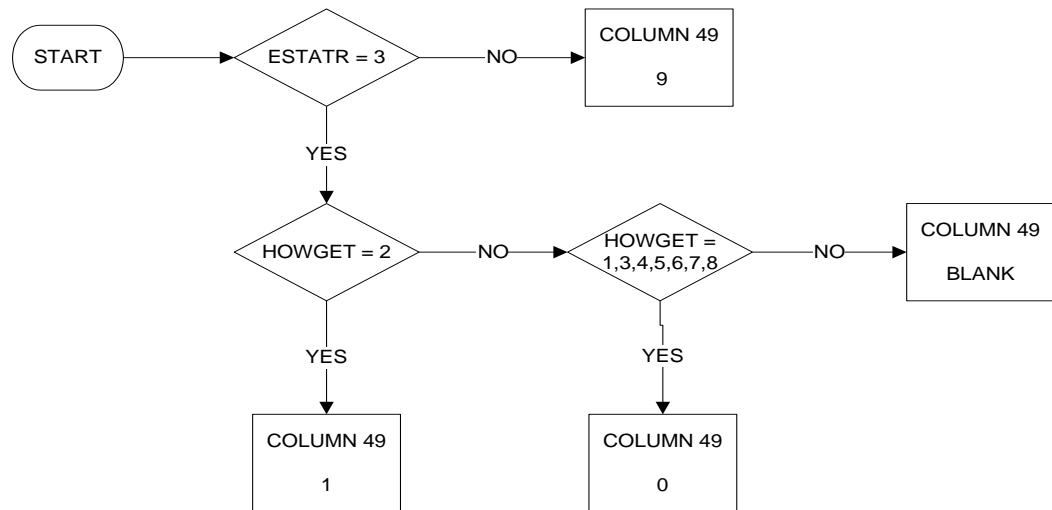

KEY	
0	No
1	Yes
9	Not Applicable (STAPRO is not equal to 3 or has started this job more than 1 year ago)
blank	No answer

FTPT (EFTPTWKR): Full-time/part-time distinction

Column 50
PAGE 1 OF 1

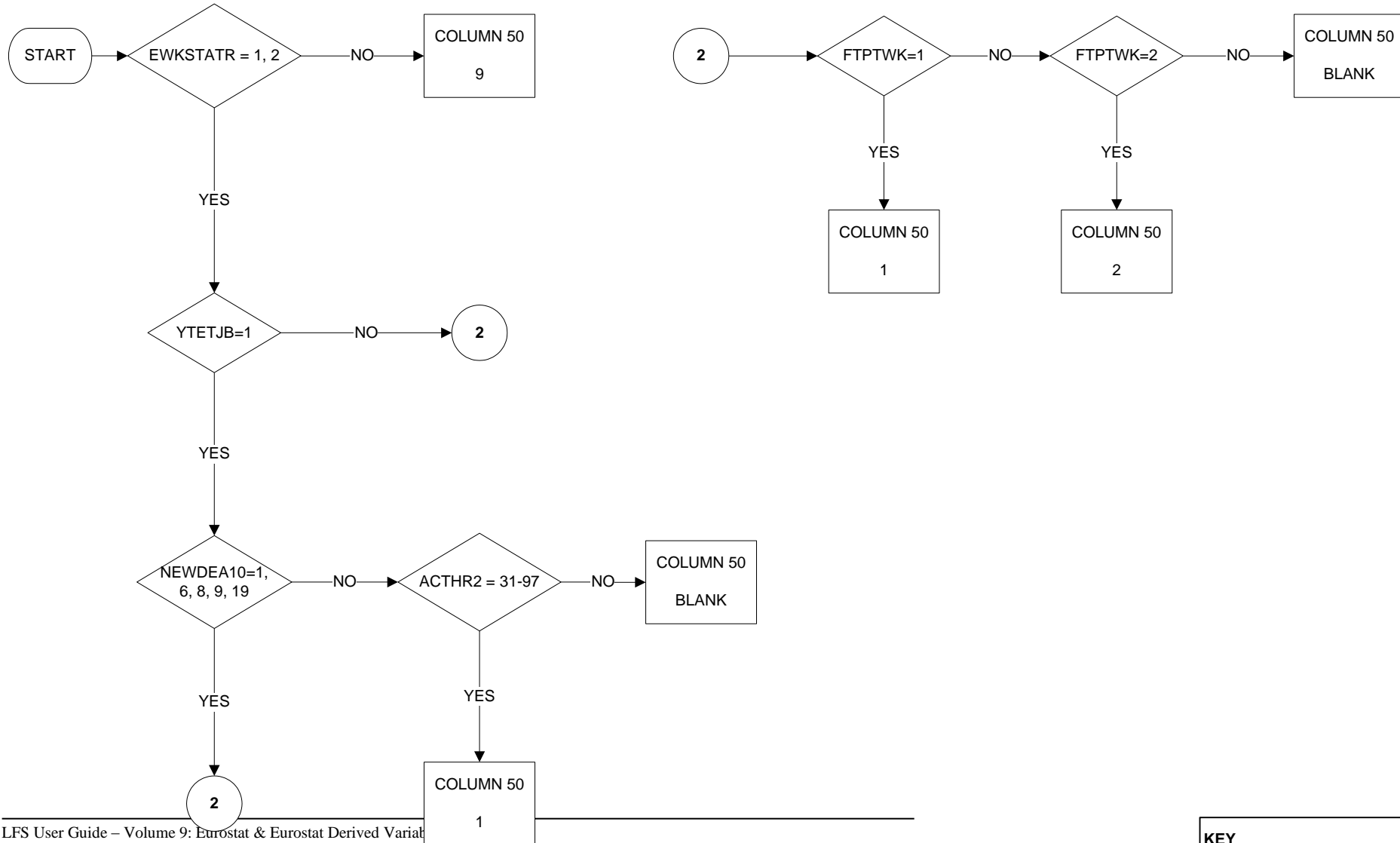

FTPTREAS (EYPTJOB): Reasons for part-time work

Column 51
PAGE 1 OF 1

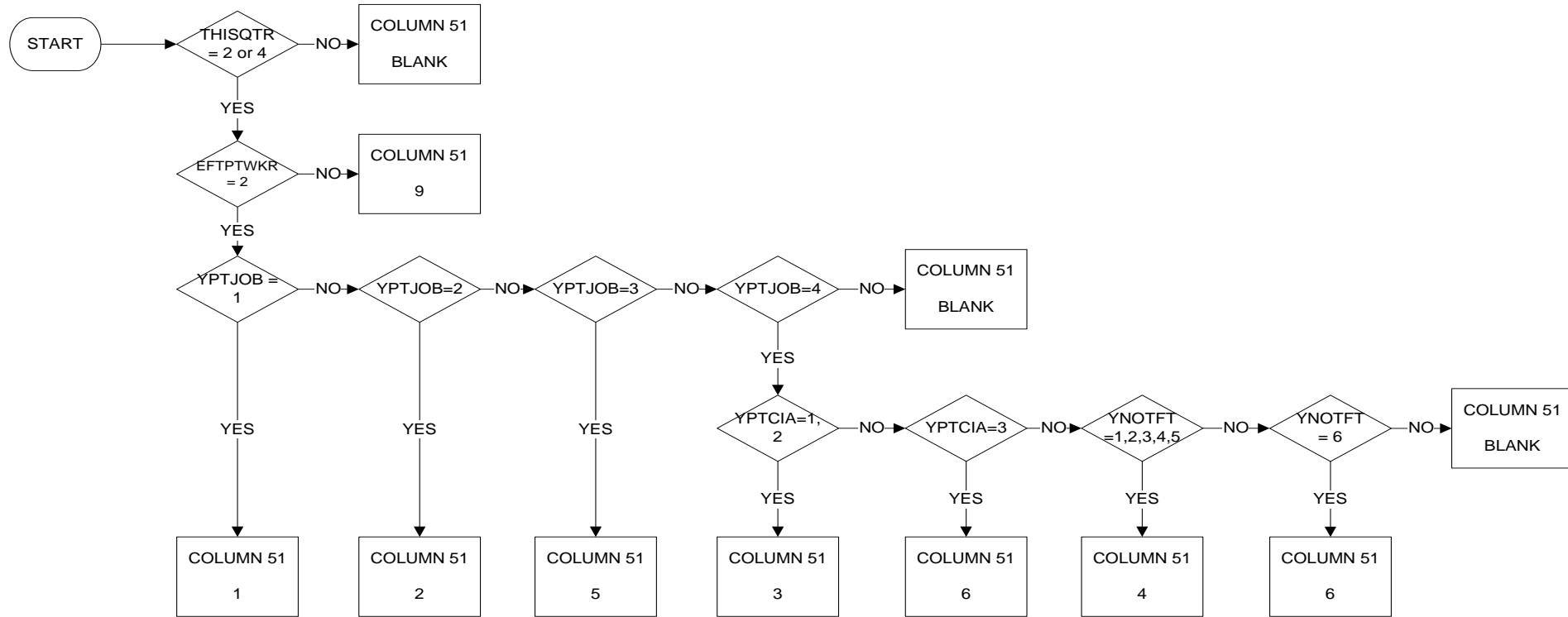

KEY

- 1 Person is undergoing school education or training
- 2 Of own illness or disability
- 3 Looking after children or incapacitated adults
- 4 Other personal or family reasons
- 5 Person could not find a full-time job
- 6 Of other reasons
- 9 Not applicable (FTPT ? 2)
- BLANK No answer

TEMP (EPERM): Permanency of first job

Column 52
PAGE 1 OF 1

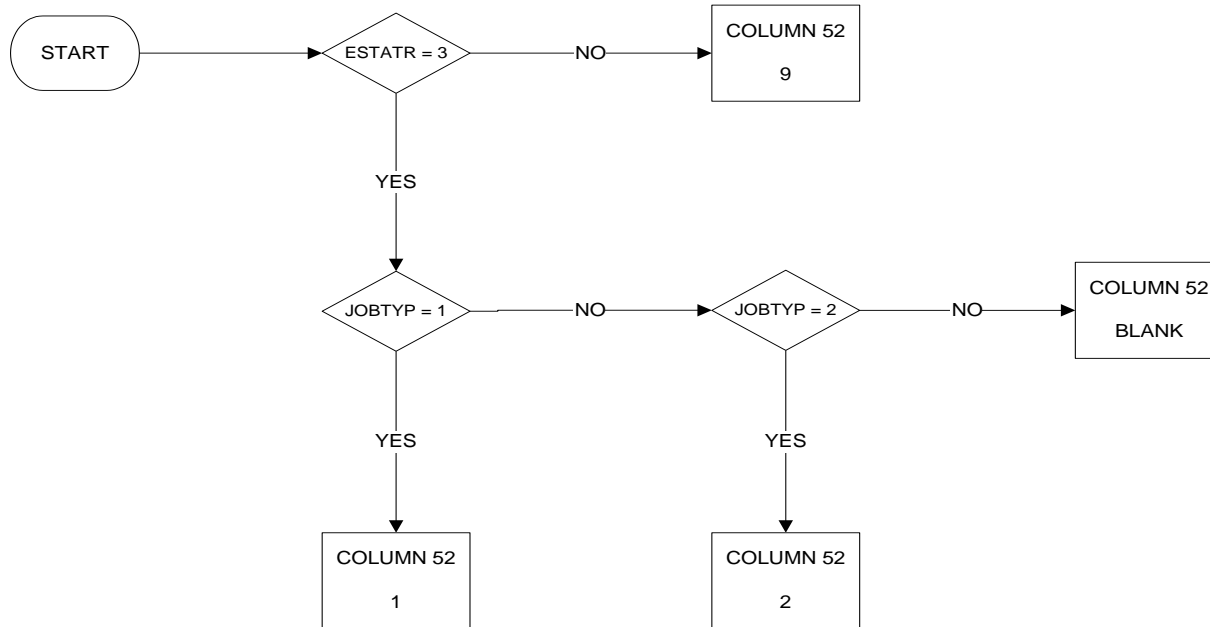

KEY

- 1 Person has a permanent job or work contract of unlimited duration
- 2 Person has temporary job/work contract of limited duration
- 9 Not applicable (ESTATR ? 3)
- Blank No answer

TEMPREAS (EWHYTMP): Reasons for having a temporary job/work contract of limited duration

Column 53
PAGE 1 OF 1

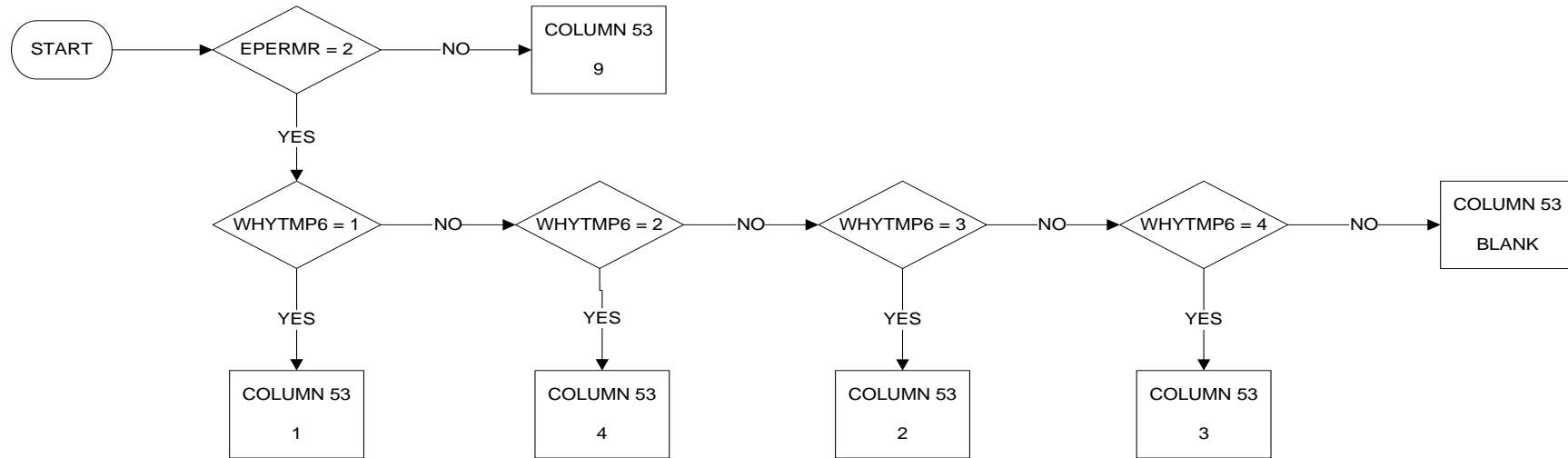

KEY	
1	It is a contract covering a period of training (apprentices, trainees, research assistants, etc.)
2	Person could not find a permanent job
3	Person did not want a permanent job
4	It is a contract for a probationary period
9	Not applicable (TEMP ? 2)
blank	No answer

TEMPDUR (EDURTMPR): Duration of temporary job

Column 54
PAGE 1 OF 1

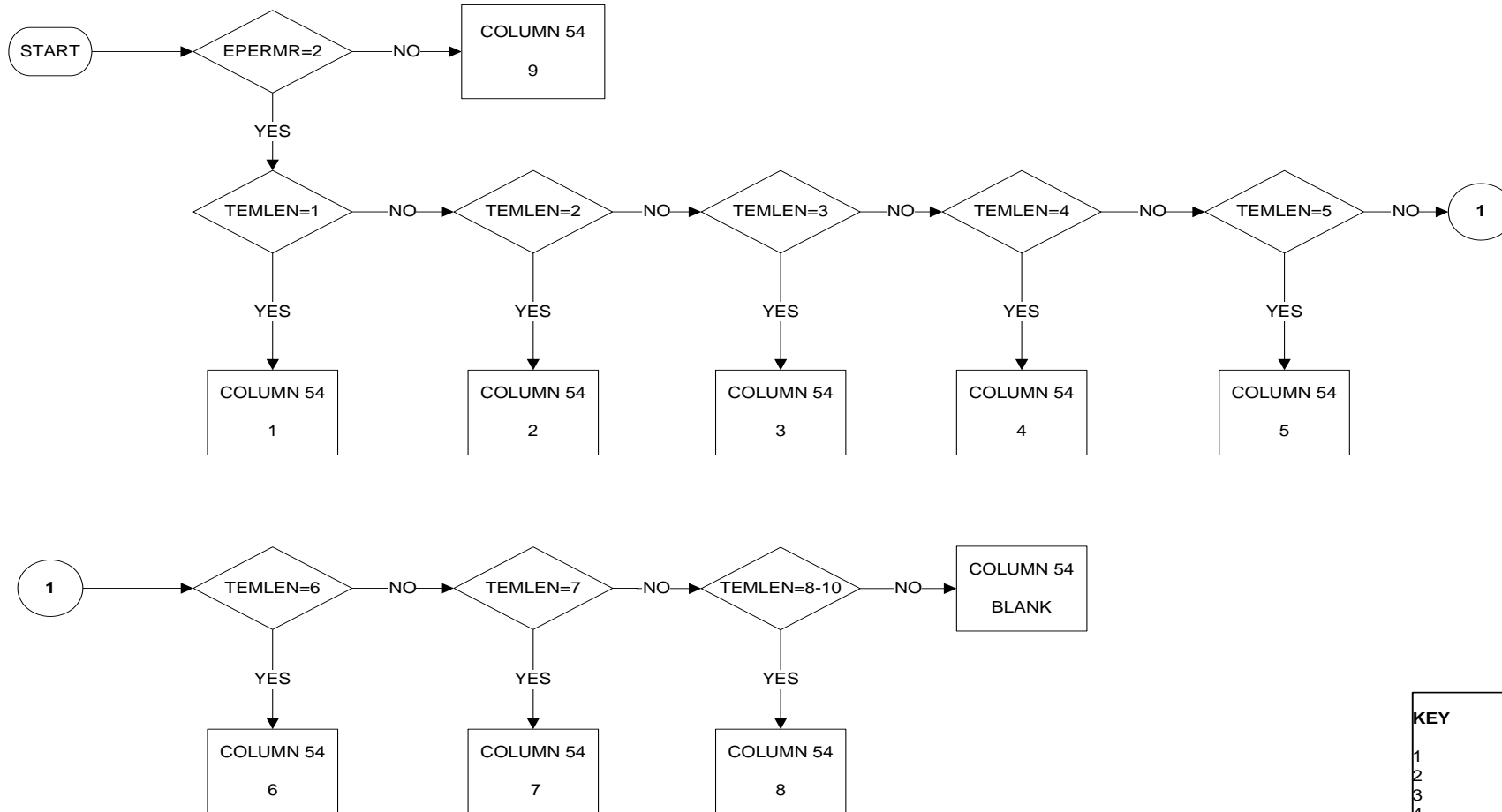

KEY	
1	Less than one month
2	1 to 3 months
3	4 to 6 months
4	7 to 12 months
5	13 to 18 months
6	19 to 24 months
7	25 to 36 months
8	More than 3 years
9	Not applicable (TEMP is not equal to 2)
Blank	No answer

TMPAGCY (ETMPCON): Contract with a temporary employment agency

Column 55
PAGE 1 OF 1

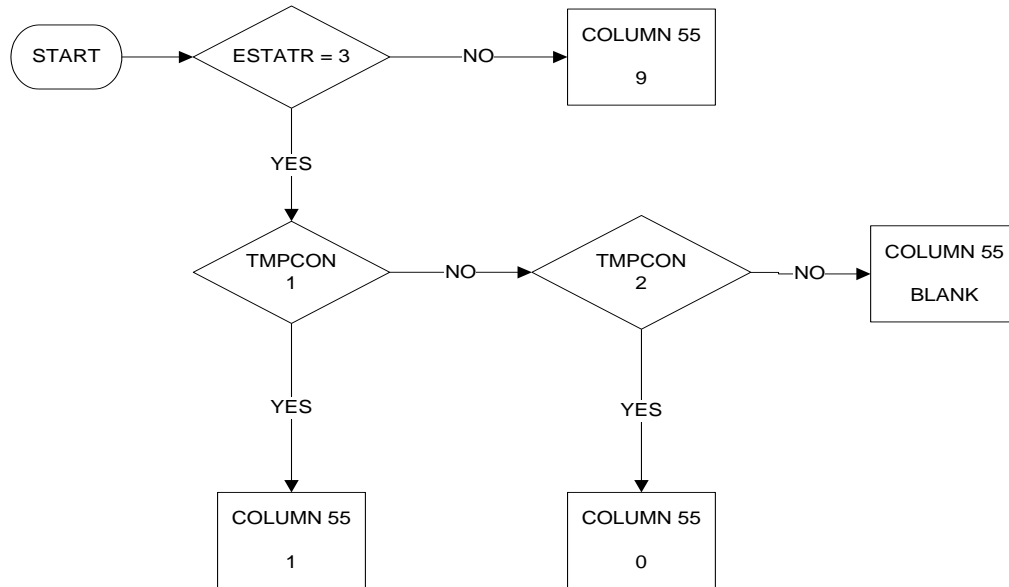

KEY	
0	No
1	Yes
9	Not applicable (STAPRO ? 3)
blank	No answer

SHIFTWK (ESHIFTR): Shift work

Column 56

PAGE 1 OF 1

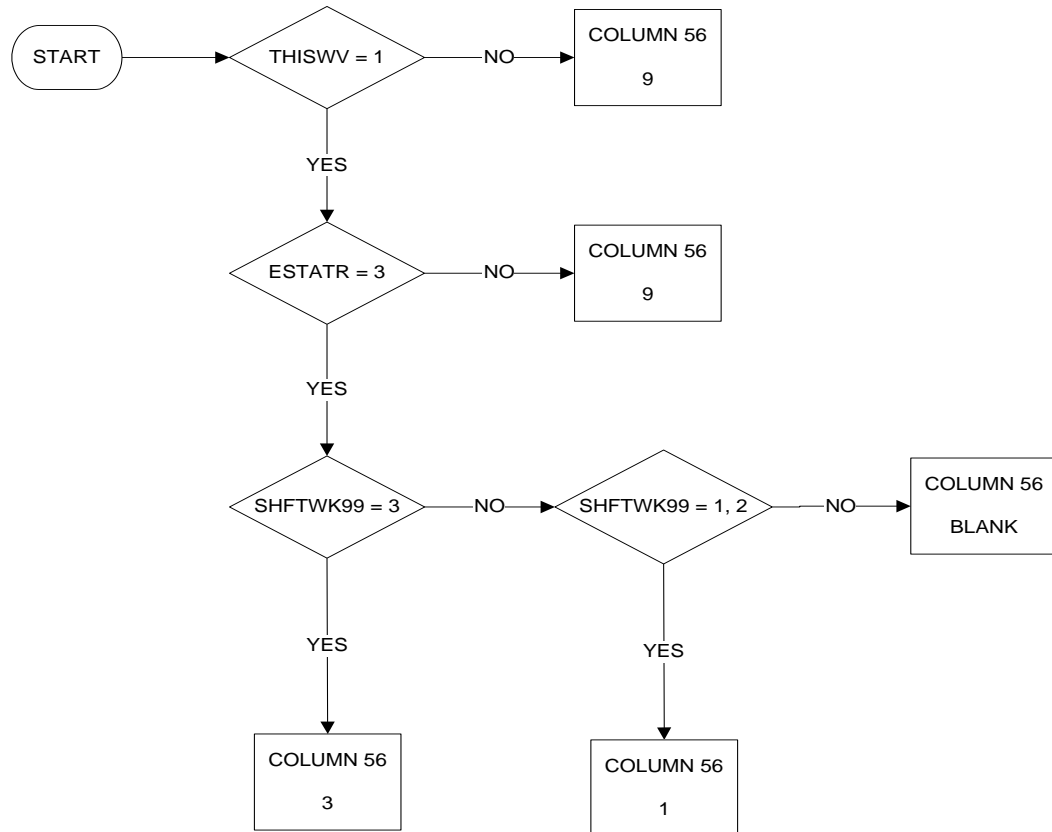

KEY

- 1 Person does shift work
- 3 Person never does shift work
- 9 Not applicable (STAPRO ? 3)
- Blank No answer

EVENWK (EEVENR): Evening work in main job

Column 57
PAGE 1 OF 1

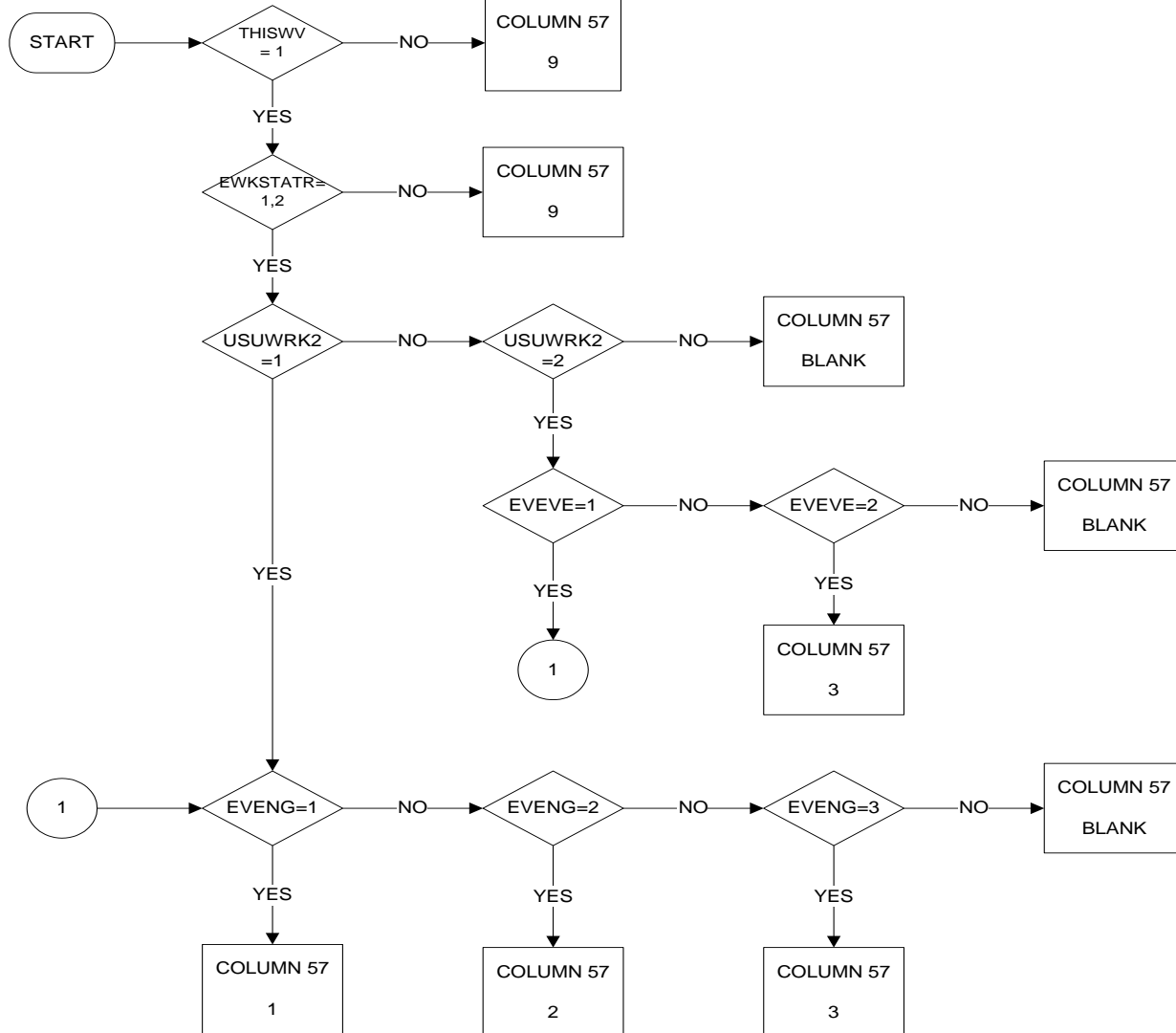

KEY	
1	Person usually works in the evening
2	Person sometimes works in the evening
3	Person never works in the evening
9	Not applicable (WSTATOR = 3-5,9)
BLANK	No Answer

NIGHTWK (ENIGHTR): Night work in main job

Column 58

PAGE 1 OF 1

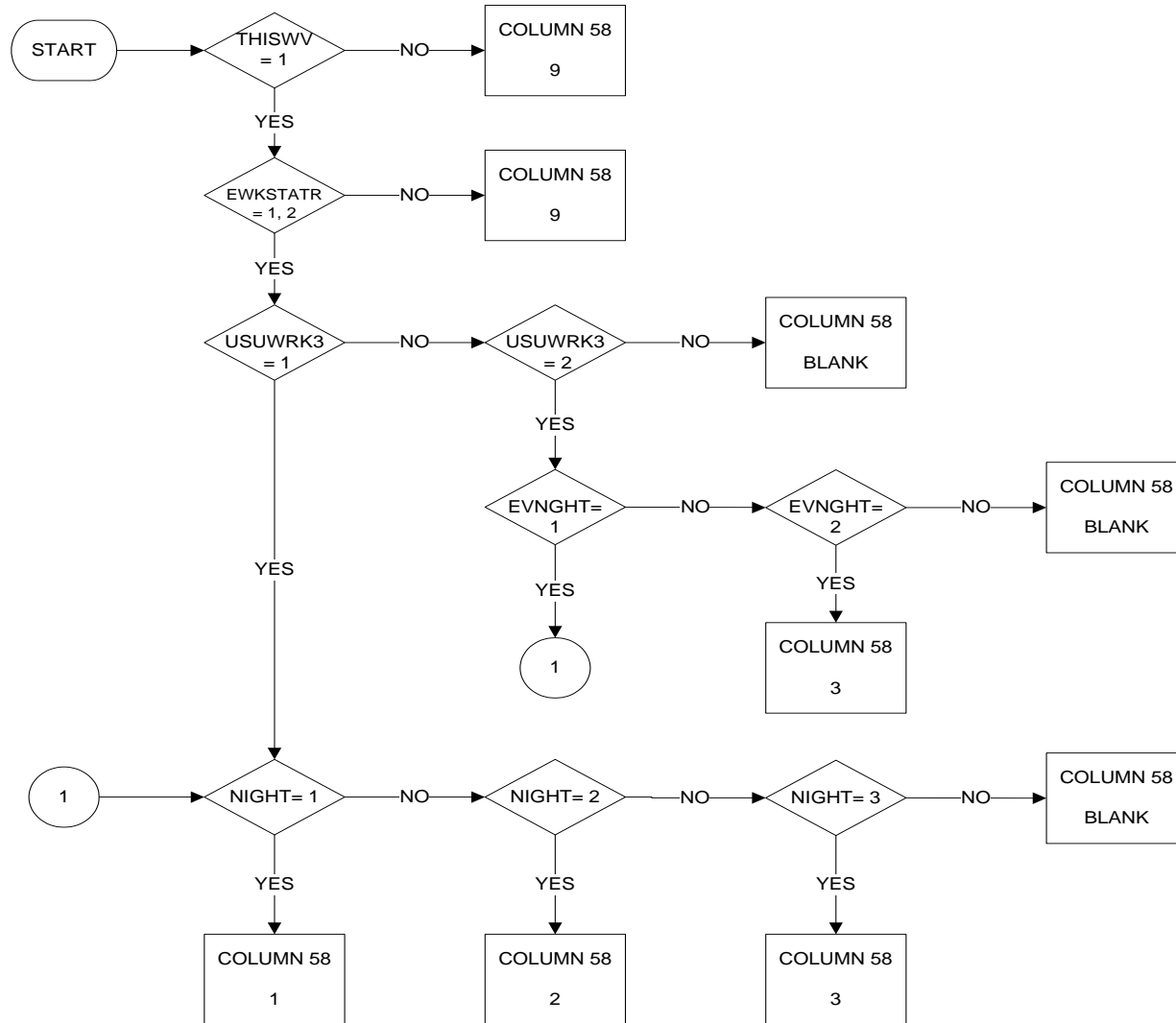

KEY

- 1 Person usually works at night
- 2 Person sometimes works at night
- 3 Person never works at night
- 9 Not applicable (WSTATOR = 3-5,9)
- BLANK No Answer

SATWK (ESATR): Saturday work in main job

Column 59

PAGE 1 OF 1

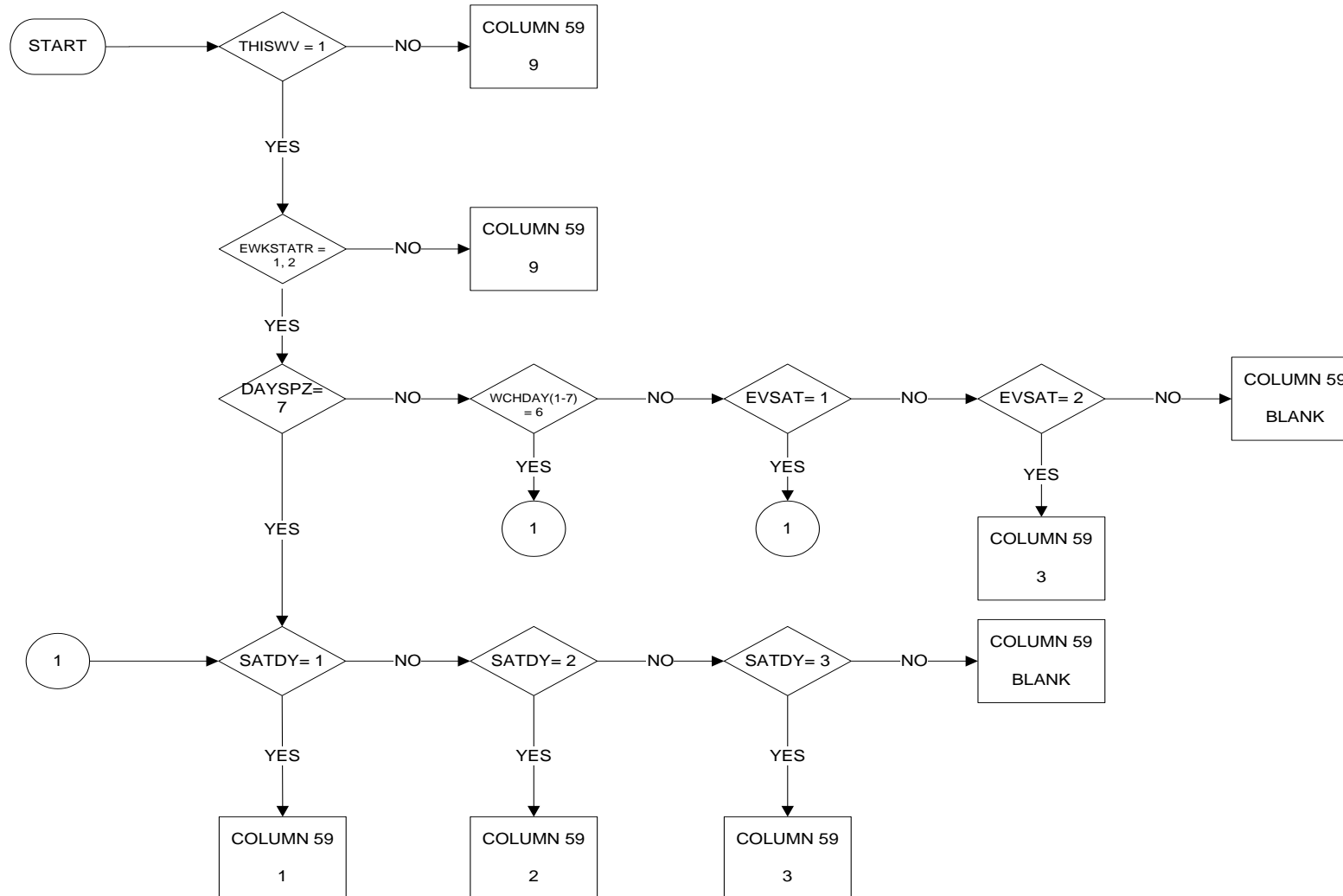

KEY	
1	Person usually works on Saturdays
2	Person sometimes works on Saturdays
3	Person never works on Saturdays
9	Not applicable (WSTATOR = 3-5,9)
Blank	No Answer

SUNWK (ESUNR): Sunday work

Column 60

PAGE 1 OF 1

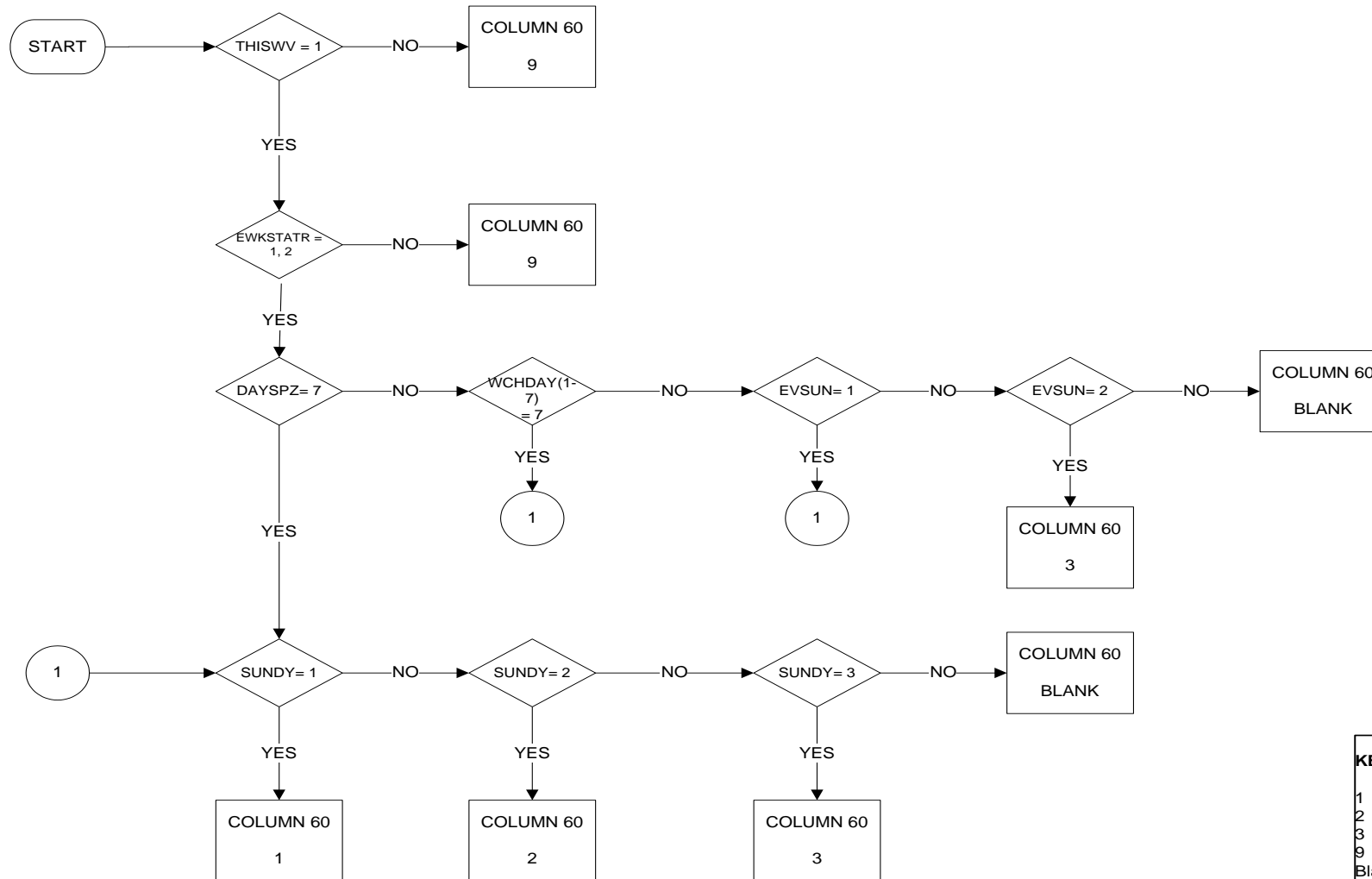

KEY	
1	Person usually works on Sundays
2	Person sometimes works on Sundays
3	Person never works on Sundays
9	Not applicable (WSTATOR = 3-5,9)
Blank	No Answer

HWUSUAL (EUSUHR): Number of hours usually worked in main job

Columns 61/62

PAGE 1 OF 1

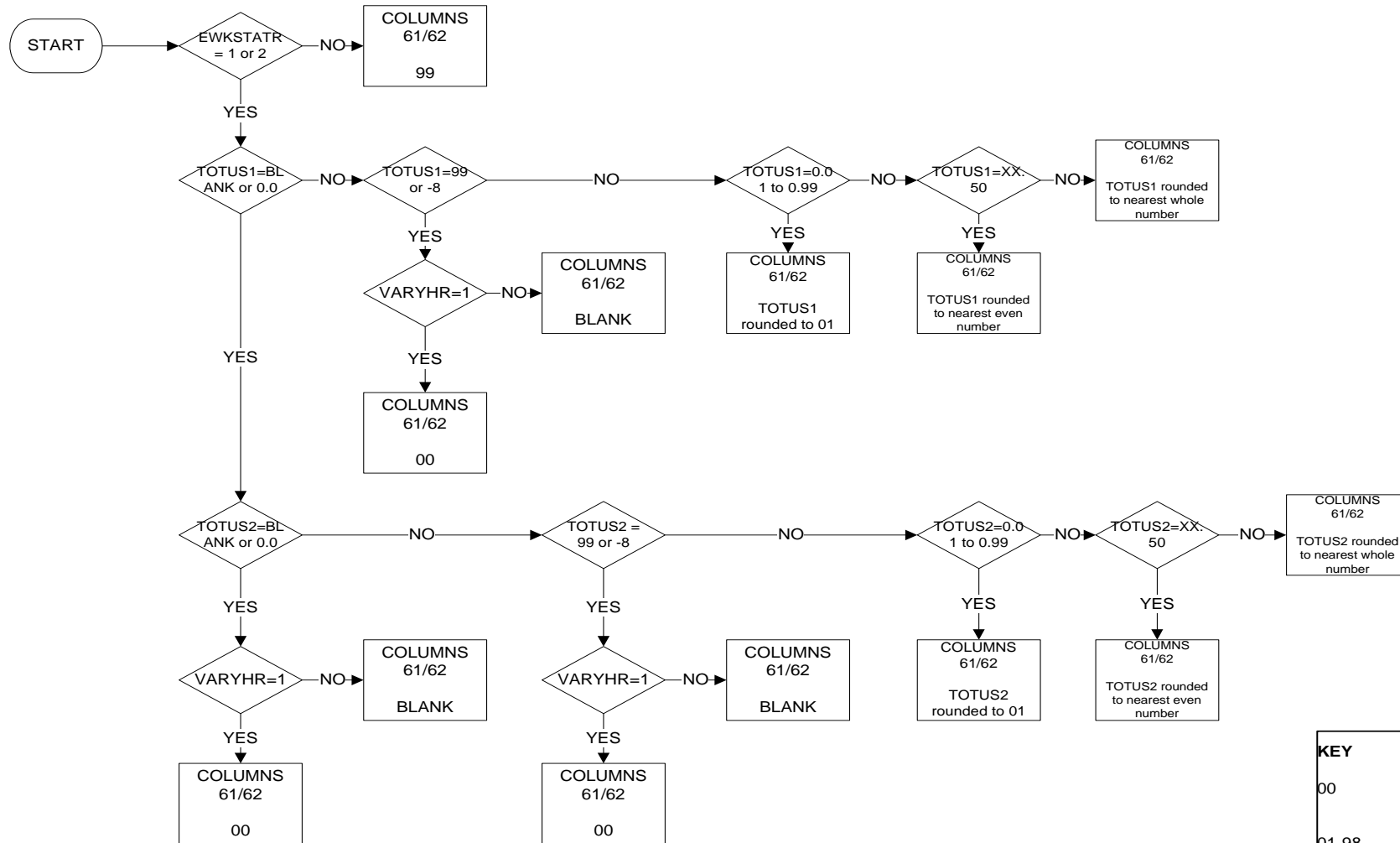

KEY	
00	Usual hours cannot be given because hours worked vary considerably from week to week or from month to month
01-98	Number of hours usually worked in the main job
99	Not applicable (WSTATOR = 3-5, 9)
BLANK	No answer

HWACTUAL (EACTHRR): Number of hours actually worked during reference week in main job

Columns 63/64

PAGE 1 OF 1

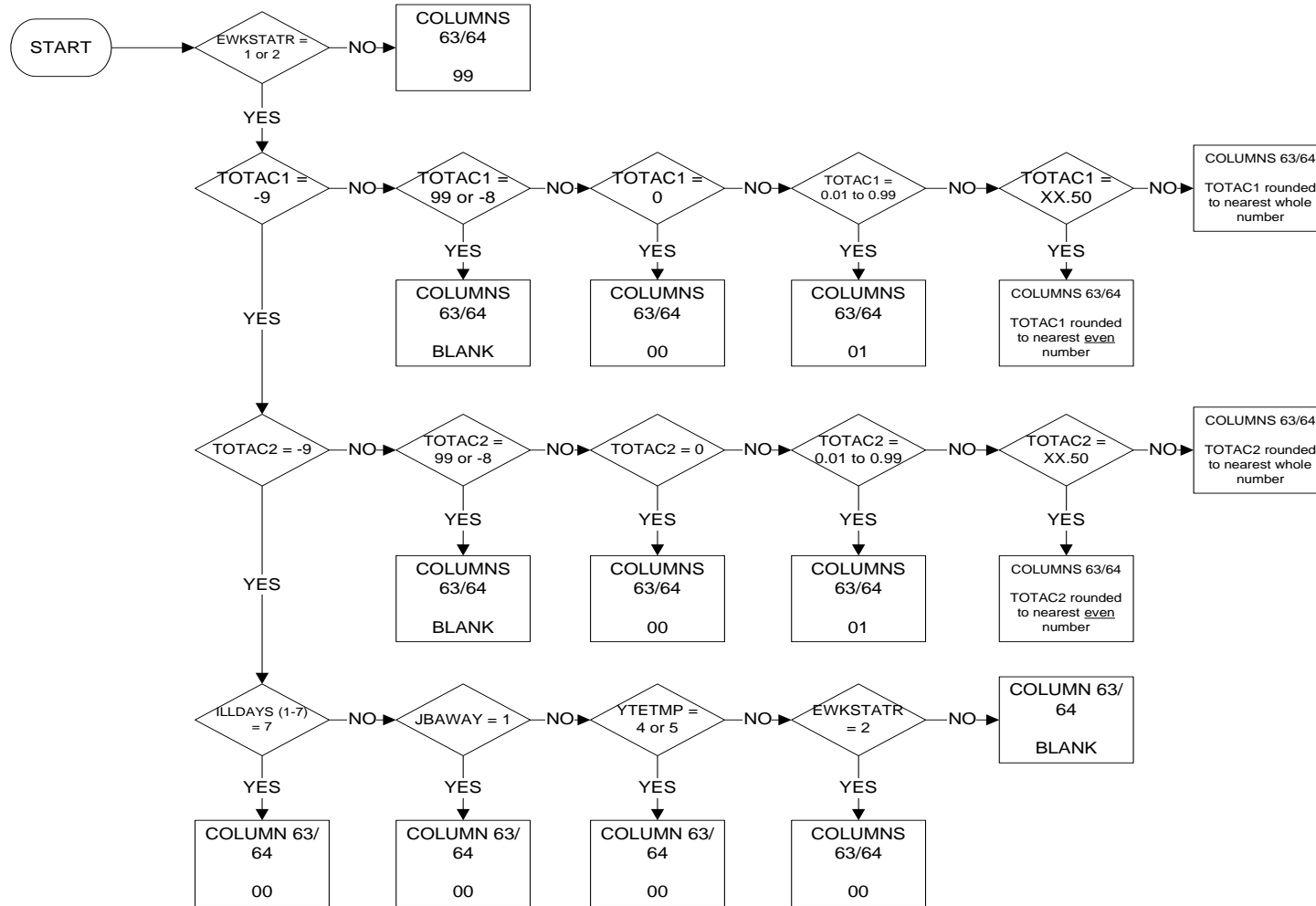

KEY

- 00 Person having a job or business and not having worked at all in the main activity during the reference week
- 01-98 Number of hours actually worked in the main job during the reference week
- 99 Not applicable (WSTATOR = 3-5 or 9)
- Blank No answer

Notes

XX is a number in the range 01 to 97. Unbiased rounding is used; so instead of always rounding up, we will round up if the number is odd, and down if the number is even.

HWOVERP (EACTPOT): Paid overtime in the reference week in the main job

Column 65/66

PAGE 1 OF 1

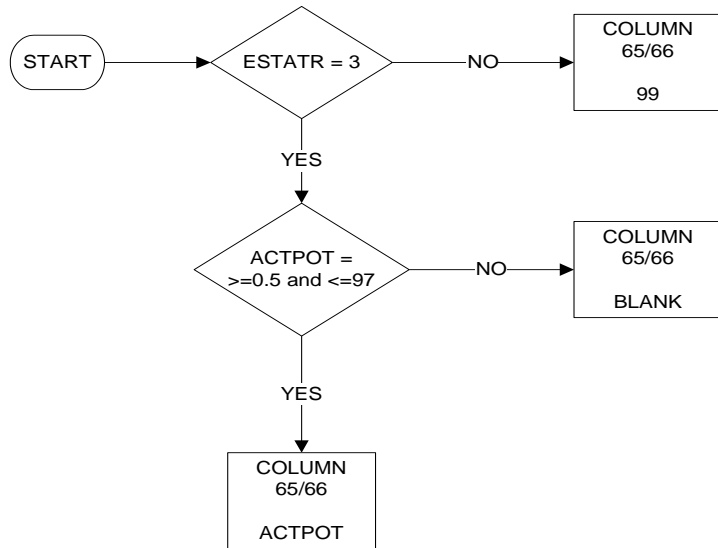

KEY

00-98	Number of paid overtime hours
99	Not applicable (STAPRO is not equal to 3)
BLANK	No answer

HWOVERPU (EACTUOT): Unpaid overtime in the reference week in the main job

Columns 67/68

PAGE 1 OF 1

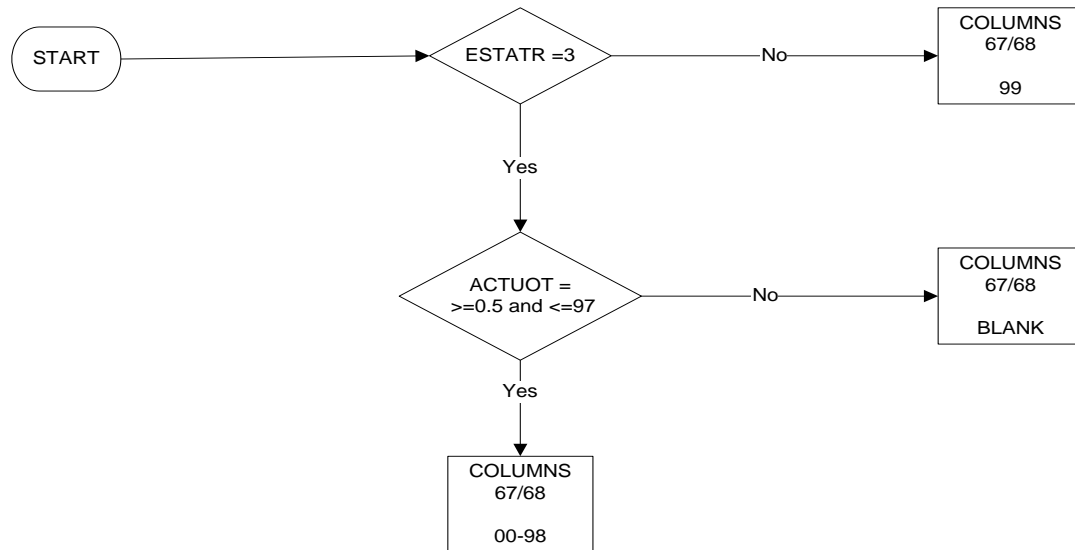

KEY

00 - 98	Number of unpaid overtime hours
99	Not Applicable (STAPRO = 3)
BLANK	No answer

HOURREAS (EWHYDIFR): Main reason why hours actually worked differed from usual hours

Columns 69/70

PAGE 1 OF 2

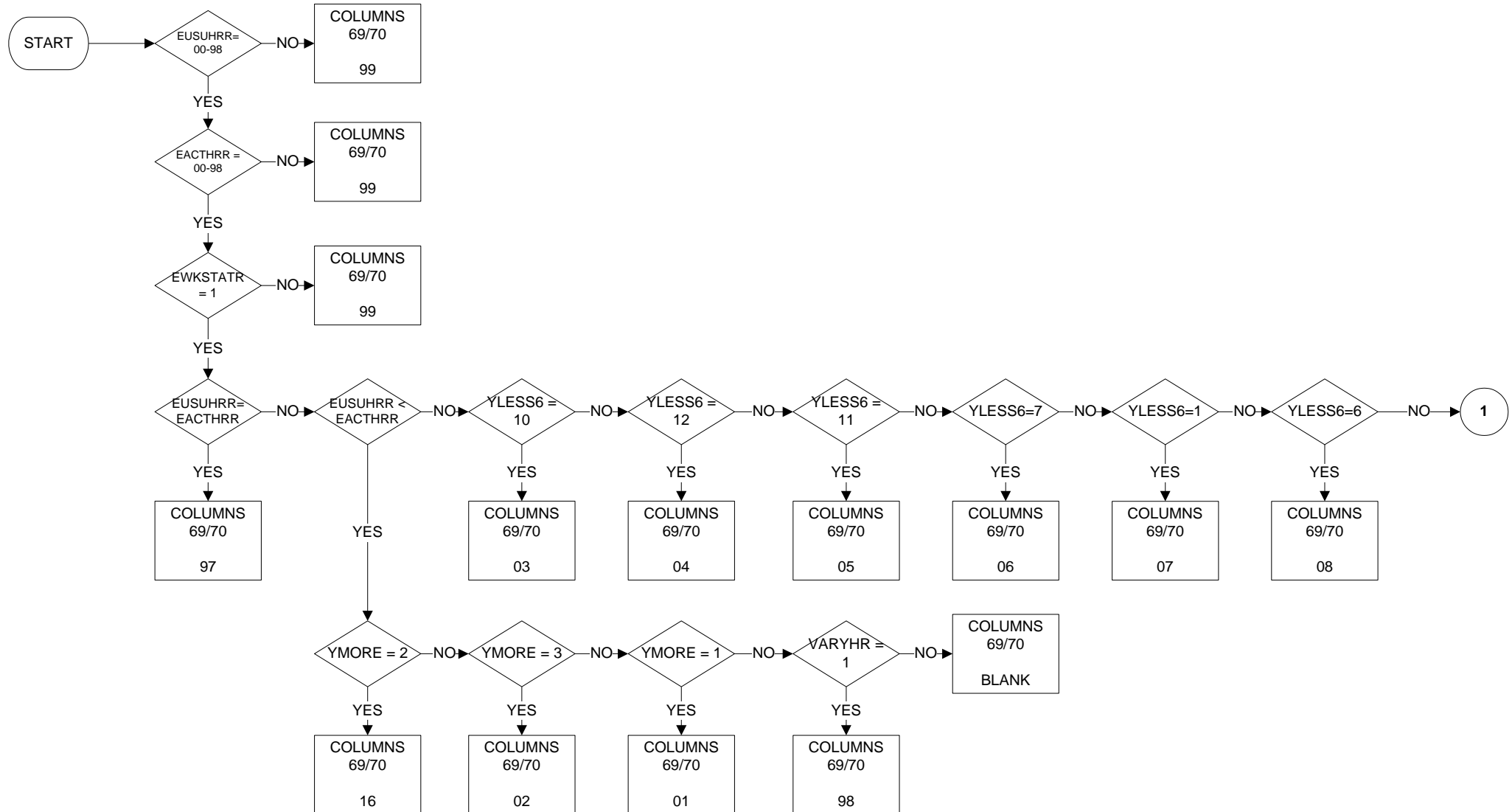

HOURREAS (EWHYDIFR): Main reason why hours actually worked differed from usual hours

Columns 69/70

PAGE 2 OF 2

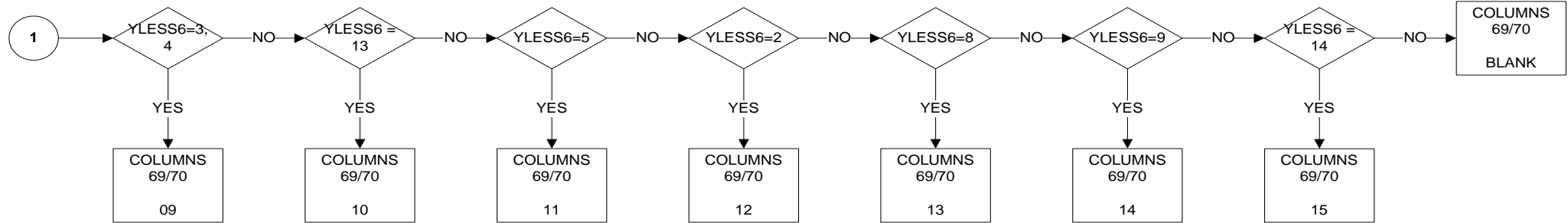

KEY

- 01 *Person has worked more than usual due to:*
- 01 Variable hours (e.g. flexible working hours)
- 16 Overtime
- 02 Other reasons
- Person has worked less than usual due to:*
- 03 Bad weather
- 04 Slack work for technical or economic reasons
- 05 Labour dispute
- 06 Education or training
- 07 Variable hours (e.g. flexible working hours)
- 08 Own illness, injury or temporary disability
- 09 Maternity or parental leave
- 10 Special leave for personal or family reasons
- 11 Annual holidays
- 12 Bank holidays
- 13 Start of/change in job during reference week
- 14 End of job without taking up a new one during reference week
- 15 Other reasons
- 97 Person having worked usual hours during the reference week (HWUSUAL = HWACTUAL = 01-98)
- 98 Person whose hours vary considerably from week to week or month to month and who did not state a reason for a divergence between the actual and usual hours (HWUSUAL = 00 & HOURREAS # 01-16)
- 99 Not applicable (WSTATOR = 2-5,9 or HWUSUAL = blank or HWACTUAL = blank)
- BLANK No answer

WISHMORE (EMHRSR): Wish to work usually more than the current numbers of hours

Column 71
PAGE 1 OF 1

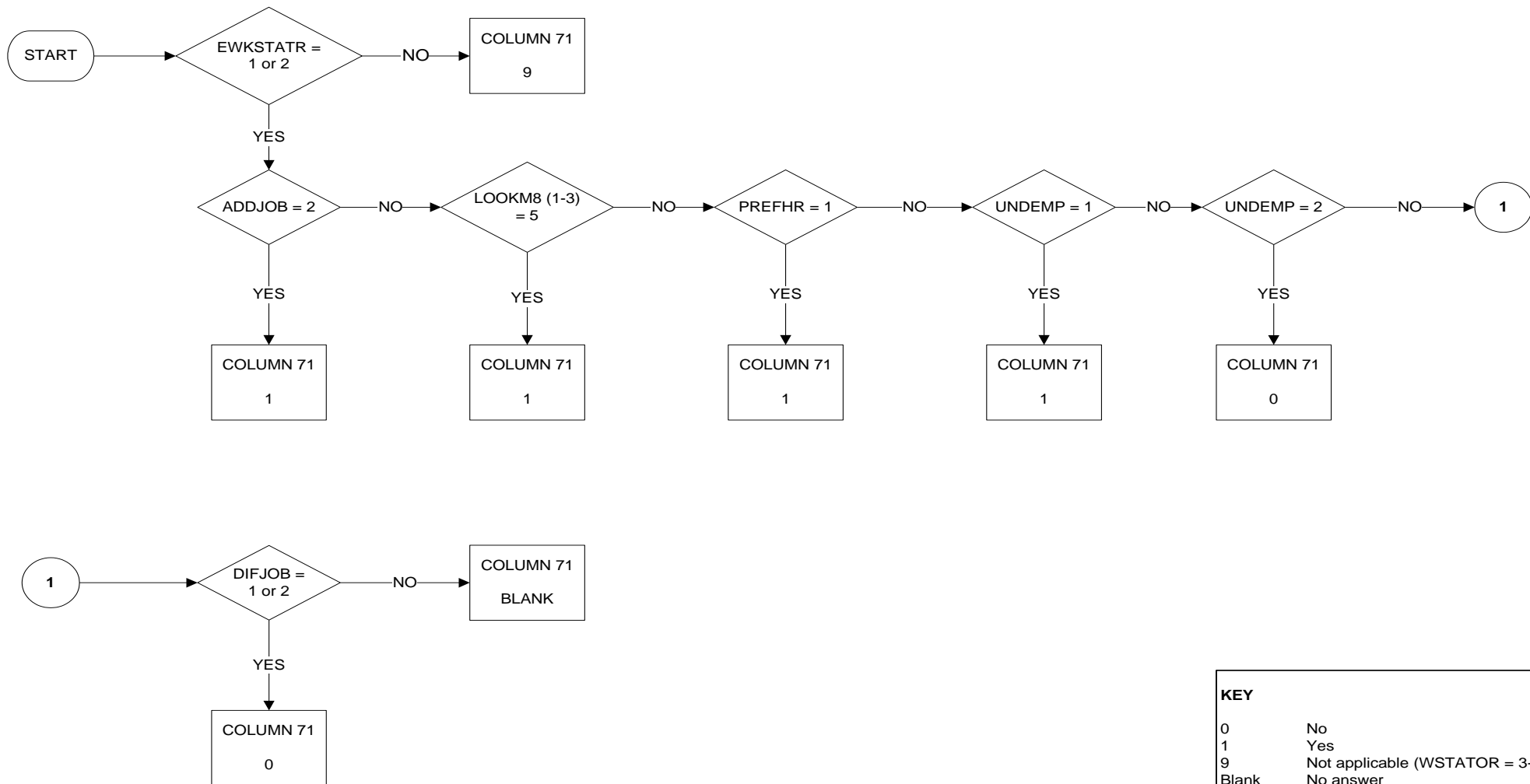

KEY	
0	No
1	Yes
9	Not applicable (WSTATOR = 3-5, 9)
Blank	No answer

WAYMORE (EWAYHRS): Way that a person can work more hours

Column 72

PAGE 1 OF 1

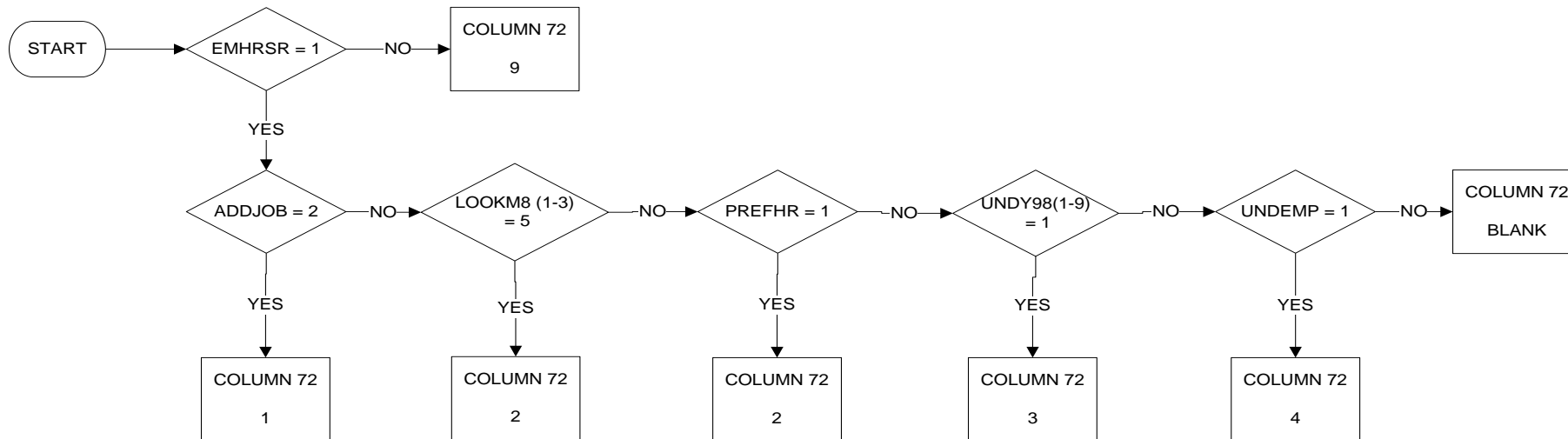

KEY	
1	Through an additional job
2	Through a job working more hours than the present job
3	Only within the present job
4	In any of the above ways
9	Not applicable (WISHMORE ? 1)
BLANK	No Answer

HWWISH (ENUMHRSR): Number of hours would like to work in total

Columns 73/74

PAGE 1 OF 1

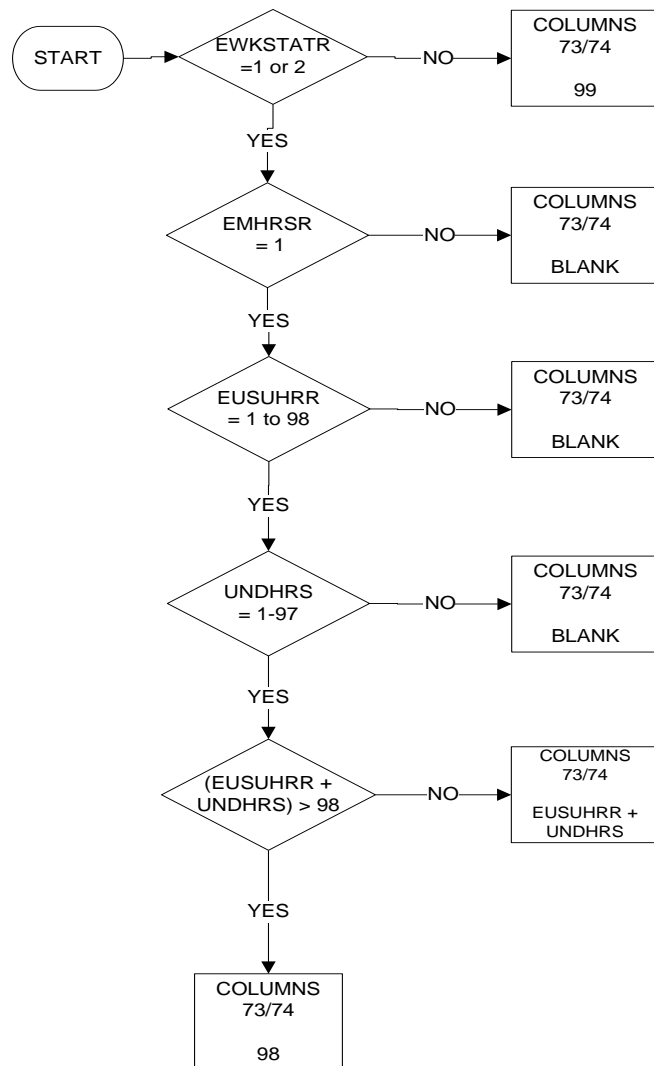

KEY	
01 - 98	Number of hours wished to work in total
99	Not applicable (WSTATOR = 3-5,9)
BLANK	No answer

HOMEWK (EHOMER): Working at home in the first job

Column 75
PAGE 1 OF 1

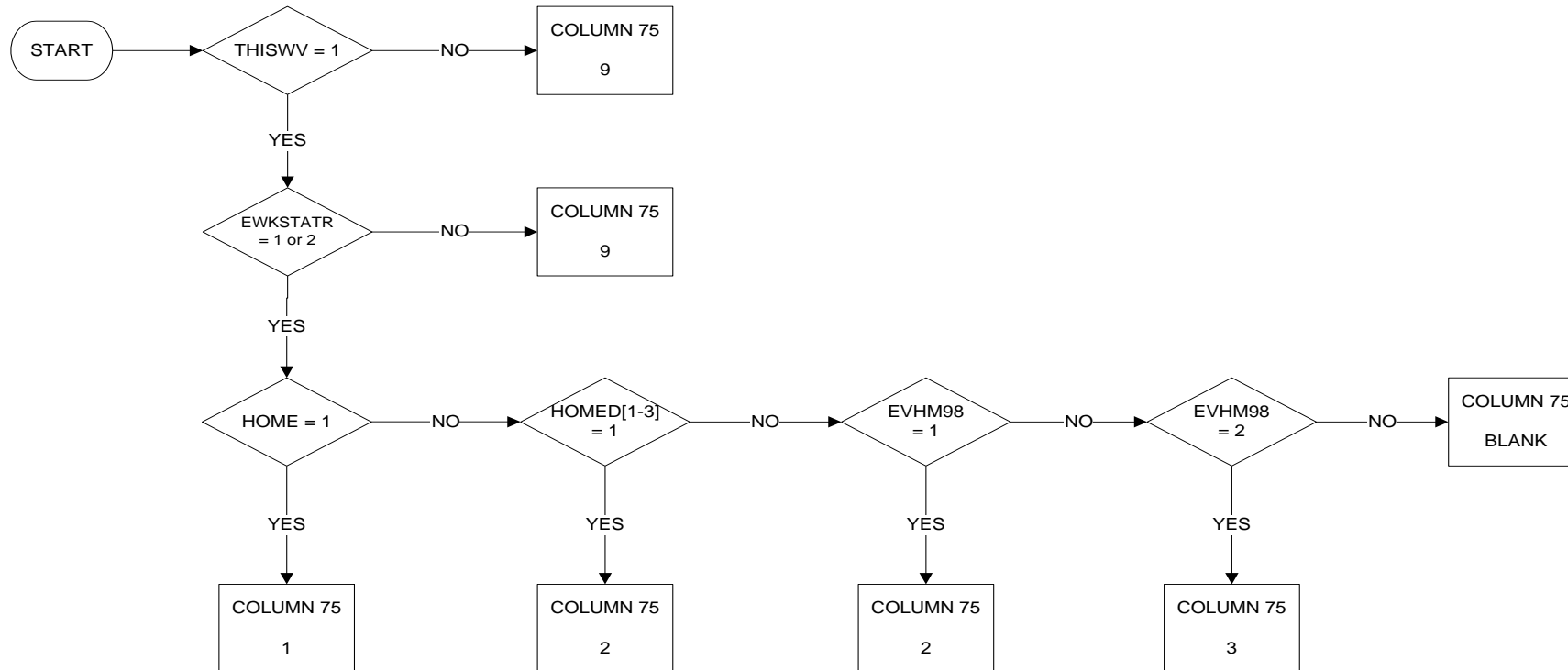

KEY	
1	Person usually works at home
2	Person sometimes works at home
3	Person never works at home
9	Not applicable (WSTATOR = 3-5 or 9)
Blank	No Answer

LOOKOJ (EADDWKR): Looking for another job

Column 76
PAGE 1 OF 1

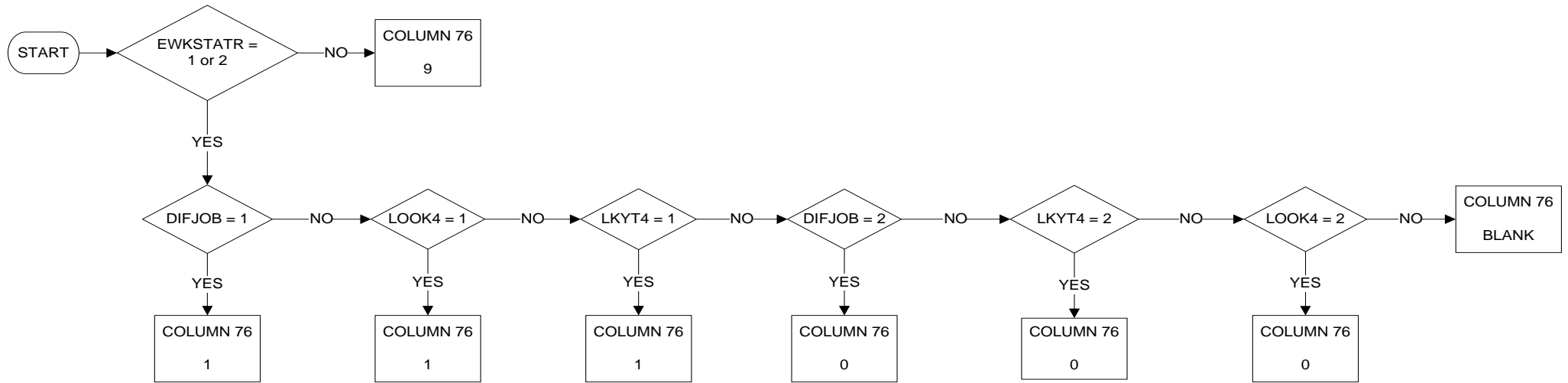

KEY	
0	Person is not looking for another job
1	Person is looking for another job
9	Not applicable (WSTATOR = 3-5, 9)
BLANK	No answer

LOOKREAS (EADDREA): Reasons for looking for another job

Column 77
PAGE 1 OF 1

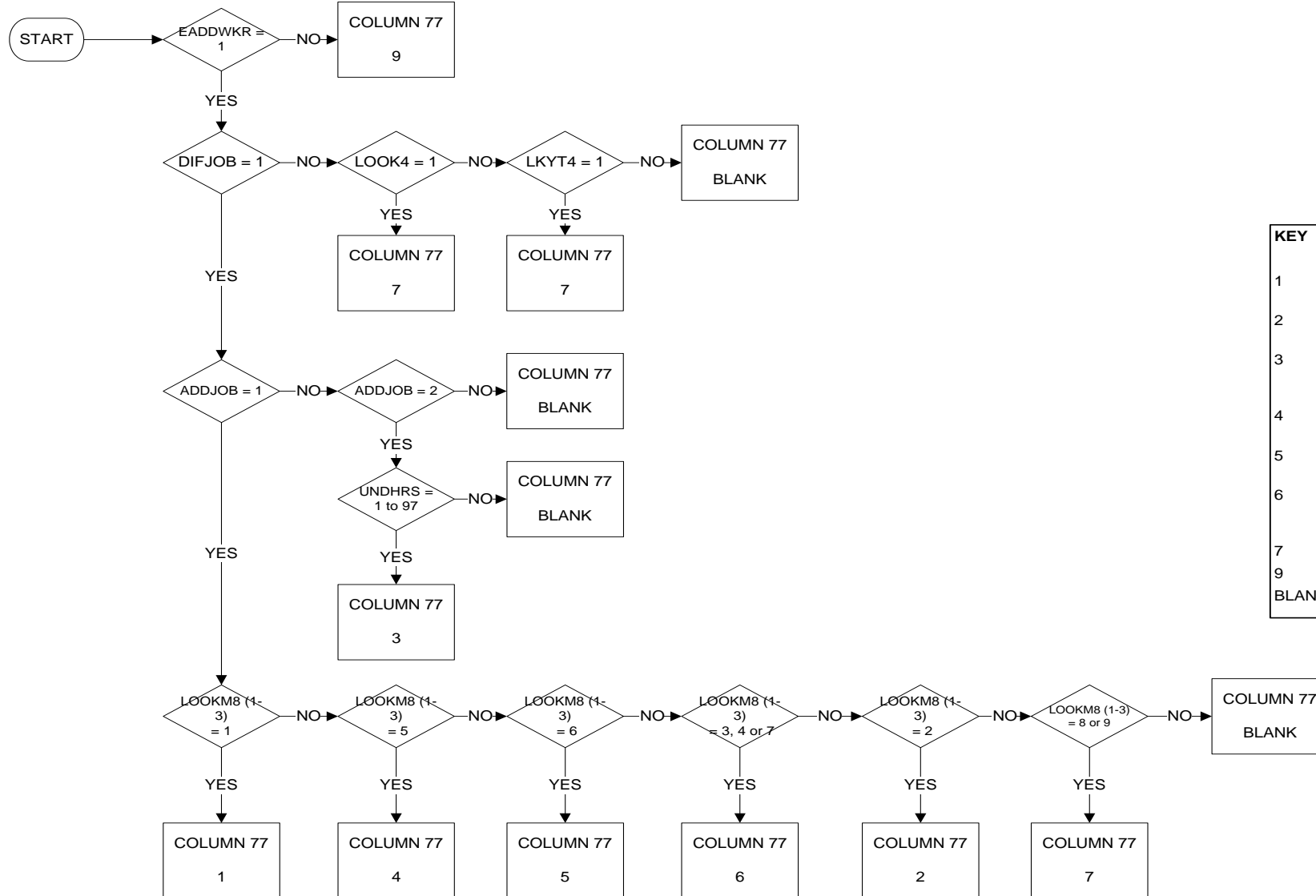

KEY	
1	Risk or certainty of loss or termination of present job
2	Actual job is considered as a transitional job
3	Seeking an additional job to add more hours to those worked in present job
4	Seeking a job with more hours worked than in present job
5	Seeking a job with less hours worked than in present job
6	Wish to have better working conditions (e.g. pay, working or travel time, quality of work)
7	Other reasons
9	Not applicable (LOOKOJ ? 1)
BLANK	No answer

EXIST2J (ESECJOB): Existence of more than one job or business

Column 78

PAGE 1 OF 1

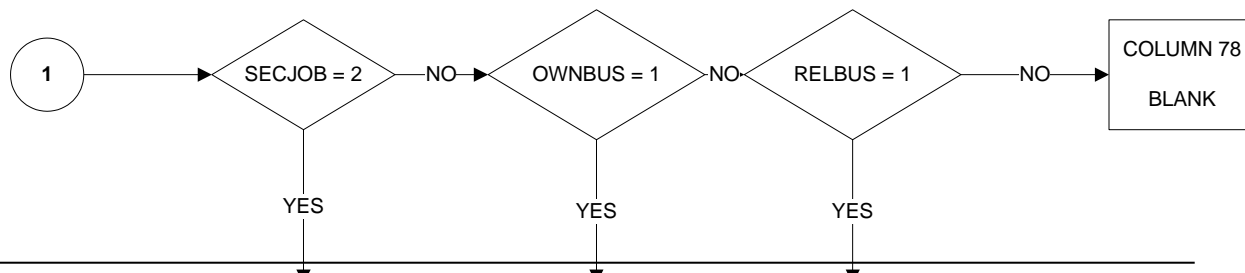
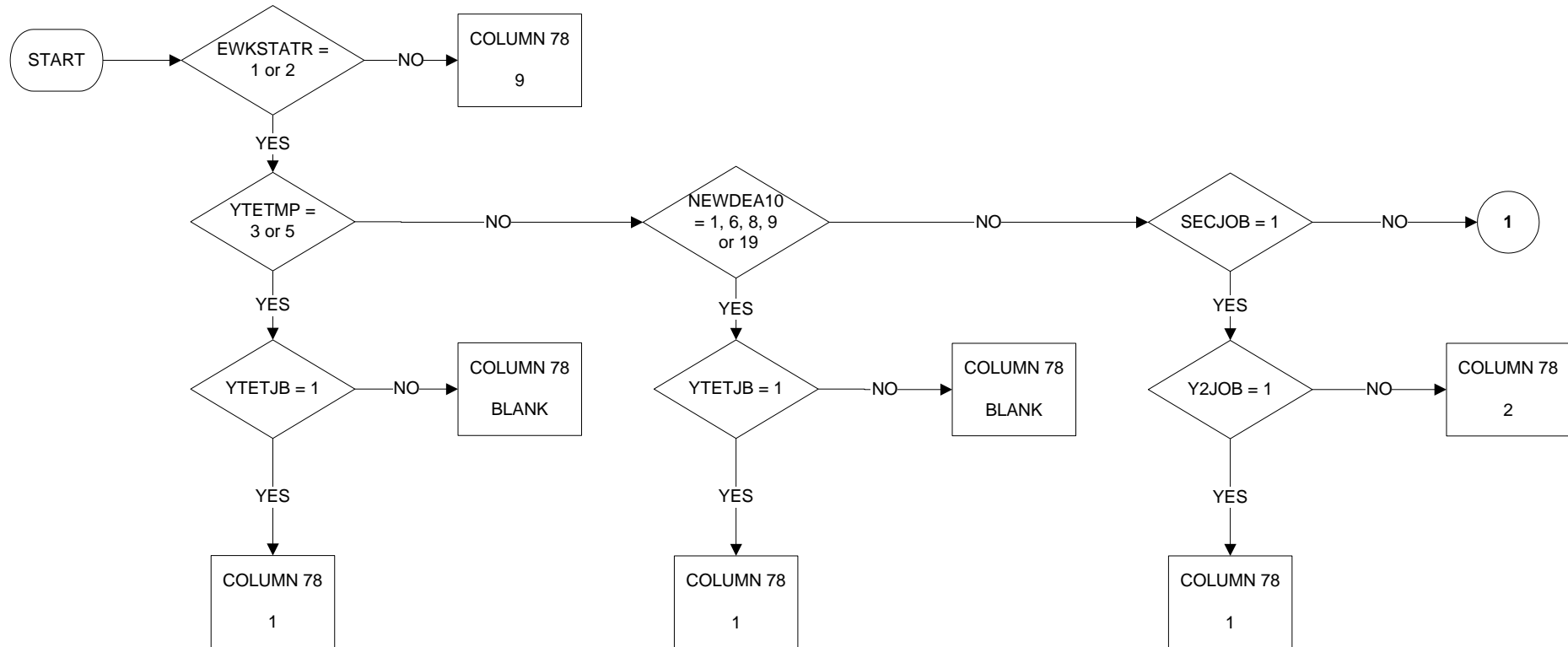

KEY	
1	Person had only one job or business during the reference week
2	Person had more than one job or business during the reference week (not due to change of job or business)

STAPRO2J (ESTAT2R): Professional status in second job

Column 79

PAGE 1 OF 1

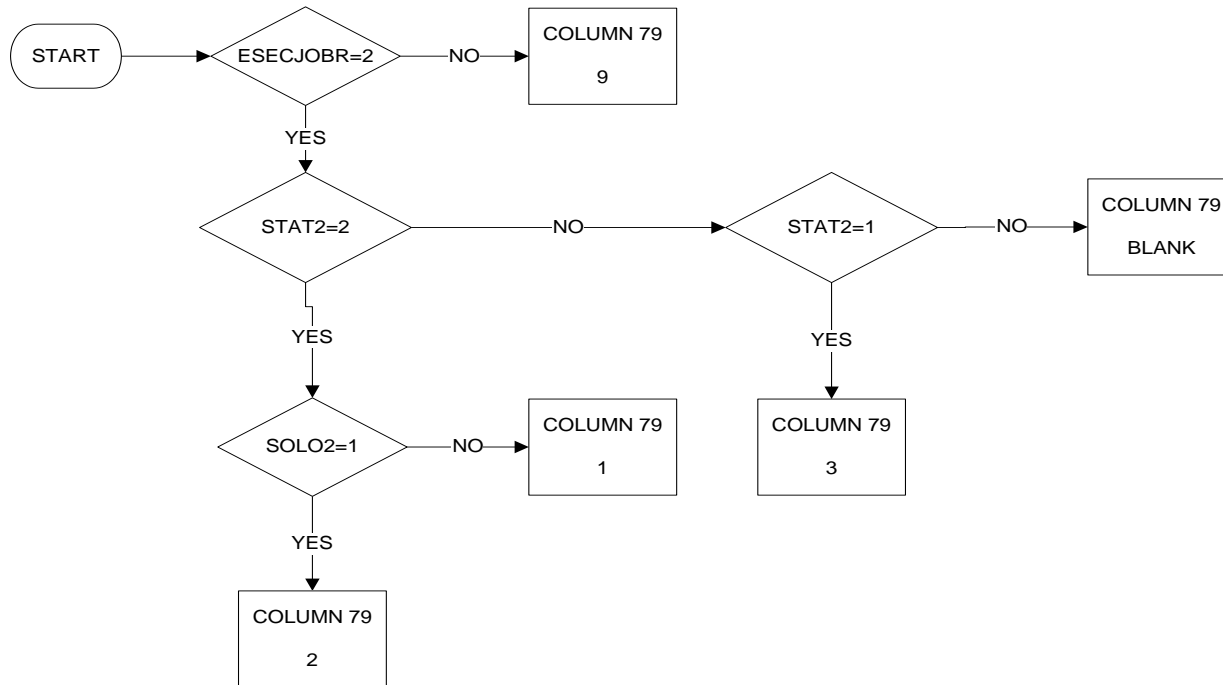

KEY	
1	Self-employed with employees
2	Self-employed without employees
3	Employee
4	Family worker
9	Not applicable (EXIST2J = 1, 9, BLANK)
BLANK	No answer

NACE2J2D (ENACE208): Economic activity of the local unit (in the second job)

Column 80/81

PAGE 1 OF 1

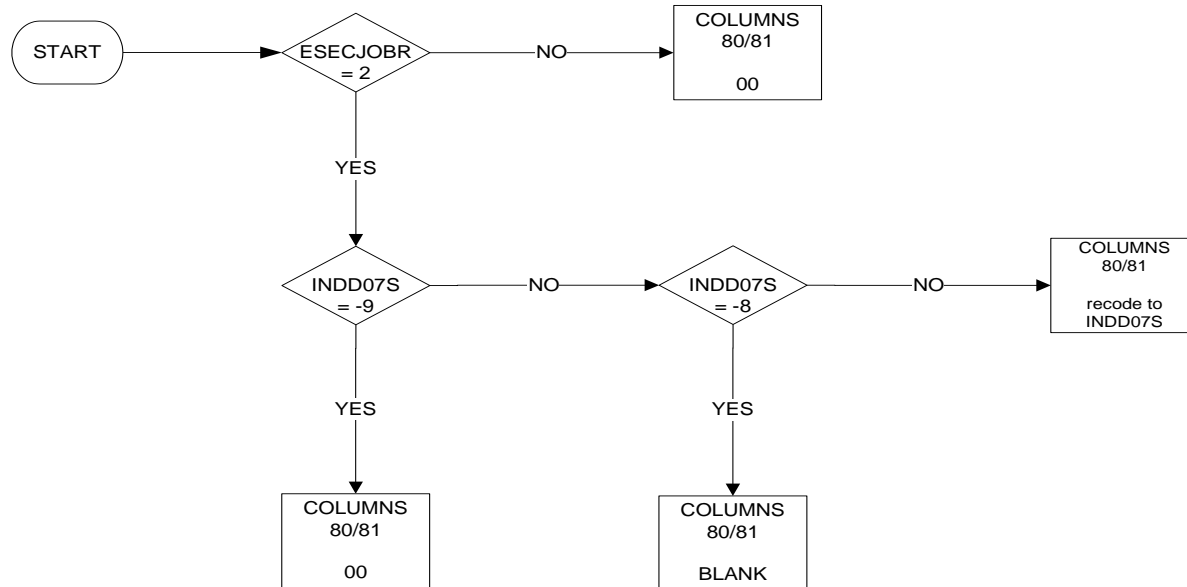

KEY	
	Nace Rev. 2
00	Not applicable (EXIST2J = 1, 9, BLANK)
Blank	No answer

HWACTUA2 (EACTHR2R): Number of hours actually worked in second job

Columns 82/83

PAGE 1 OF 1

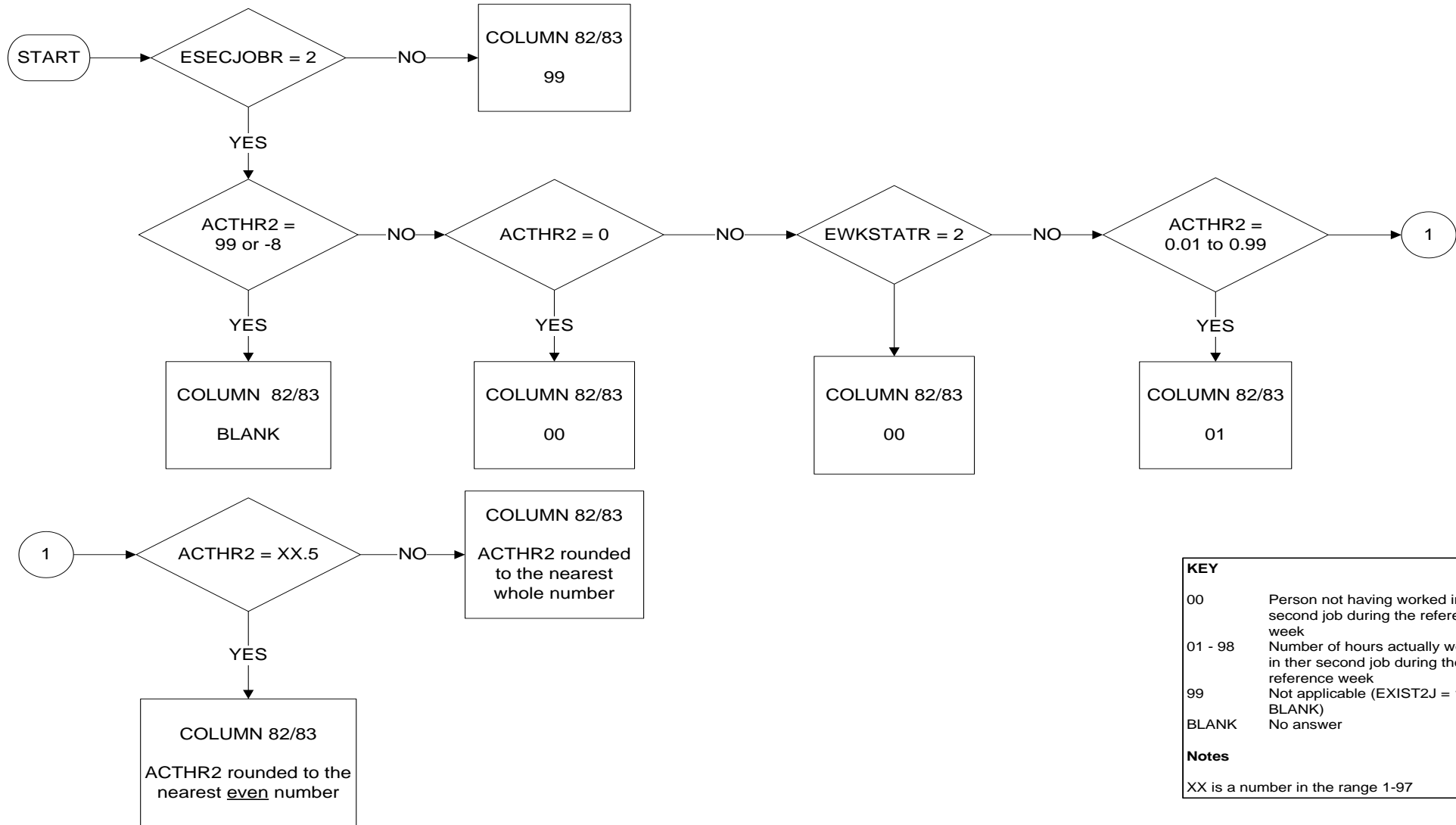

KEY	
00	Person not having worked in the second job during the reference week
01 - 98	Number of hours actually worked in their second job during the reference week
99	Not applicable (EXIST2J = 1, 9, BLANK)
BLANK	No answer
Notes	
XX is a number in the range 1-97	

EXISTPR (EEWKPR): Existence of previous employment experience

Column 84
PAGE 1 OF 1

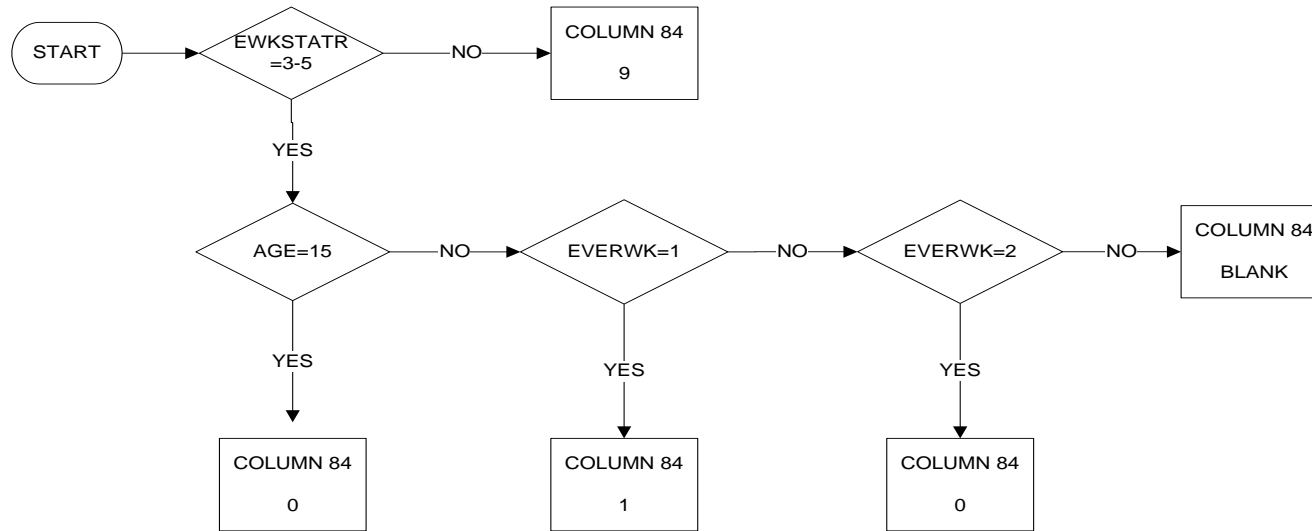

KEY	
0	Person has never been in employment (purely occasional work, such as vacation work, compulsory military or community service are not to be considered as employment)
1	Person has already been in employment (purely occasional work, such as vacation work, compulsory military or community service are not to be considered as employment)
9	Not applicable (WSTATOR = 1, 2 or 9)
BLANK	No answer

YEARPR (EYRLASTR): Year in which person last worked

Columns 85/88

PAGE 1 OF 1

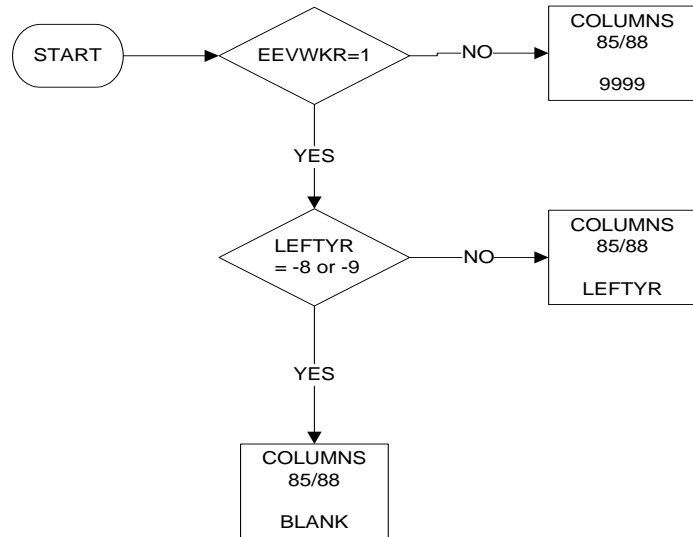

KEY	
	Enter the 4 digits of the year in which person last worked
9999	Not applicable (EXISTPR = 0, 9, BLANK)
BLANK	No answer

MONTHPR (EMNLASTR): Month in which person last worked

Columns 89/90

PAGE 1 OF 1

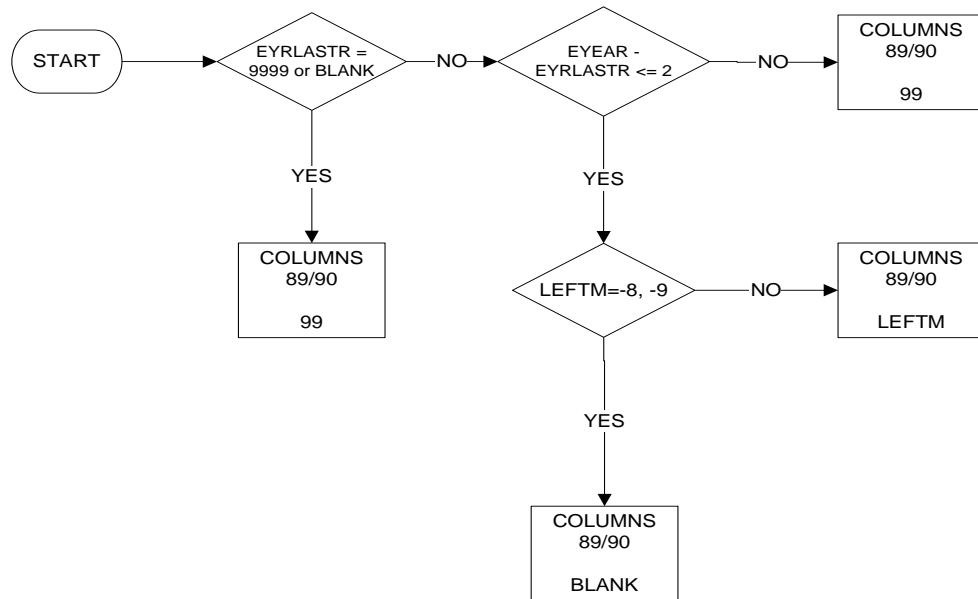

KEY	
01-12	Enter the number of the month in which person last worked
99	Not applicable (YEARPR = 9999, BLANK or REFYEAR-YEARPR>2)
BLANK	No answer

LEAVREAS (EWHYLFTR): Main reason for leaving last job or business

Column 91/92

PAGE 1 OF 1

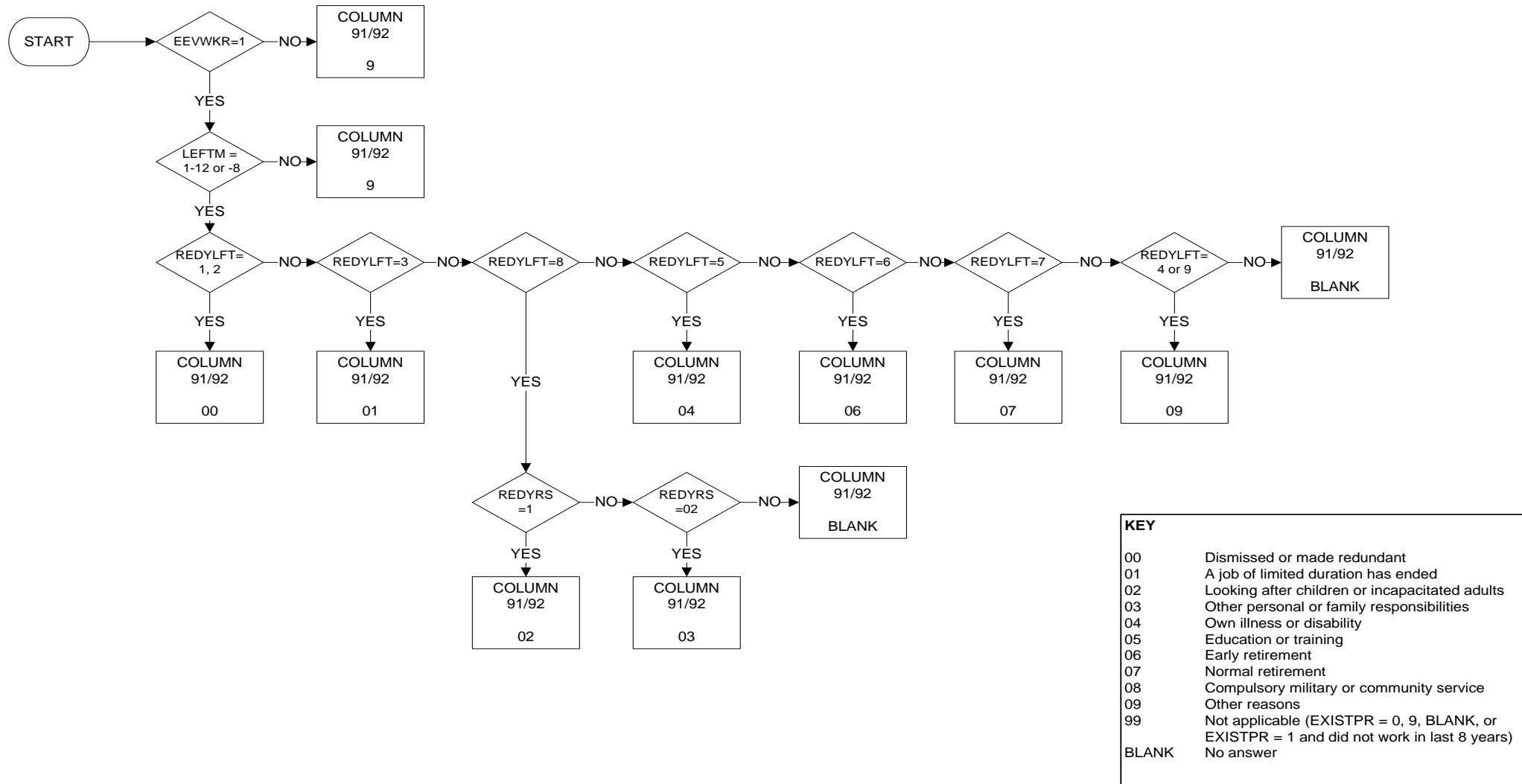

KEY	
00	Dismissed or made redundant
01	A job of limited duration has ended
02	Looking after children or incapacitated adults
03	Other personal or family responsibilities
04	Own illness or disability
05	Education or training
06	Early retirement
07	Normal retirement
08	Compulsory military or community service
09	Other reasons
99	Not applicable (EXISTPR = 0, 9, BLANK, or EXISTPR = 1 and did not work in last 8 years)
BLANK	No answer

STAPROPR (ESTATLR): Professional status in last job

Column 93

PAGE 1 OF 1

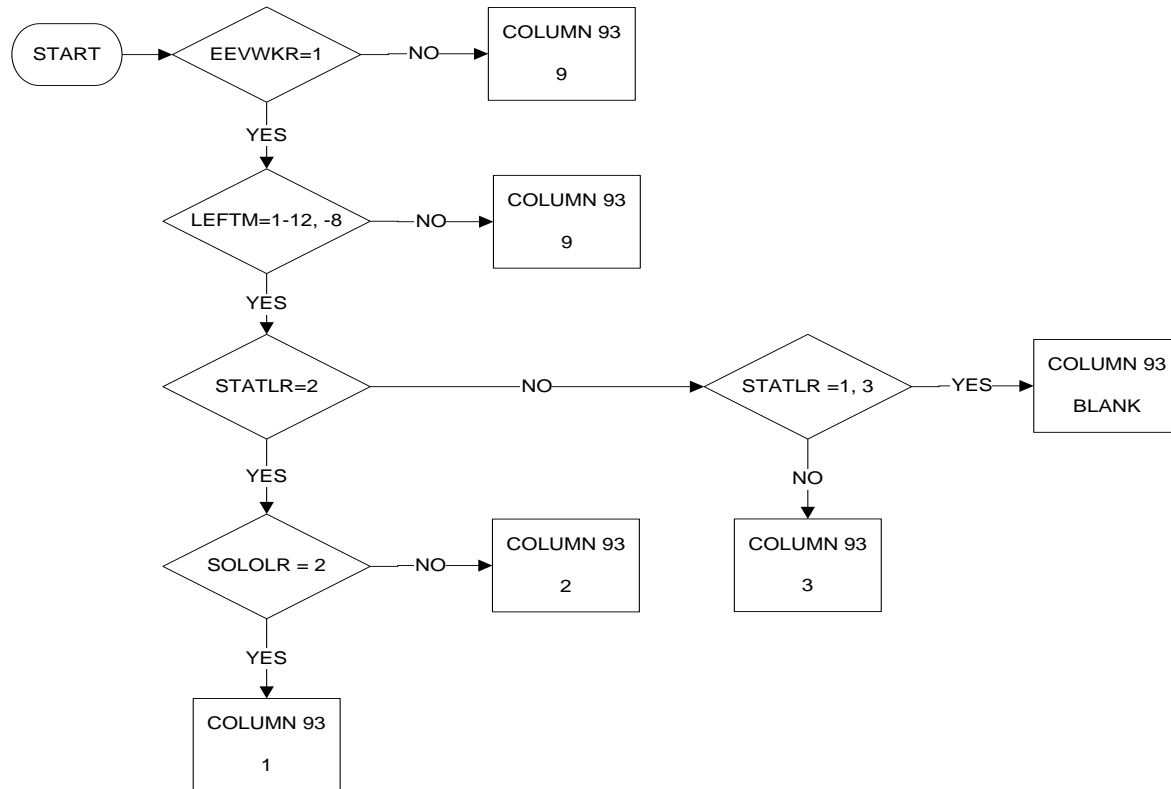

KEY	
1	Self-employed with employees
2	Self-employed without employees
3	Employee
4	Family worker
9	Not applicable (EXISTPR = 0, 9, BLANK, or EXISTPR = 1 and did not work in last 8 years)
BLANK	No answer

NACEPR2D (ENACEL08): Economic activity of the local unit in which person last worked

Column 94/95

PAGE 1 OF 1

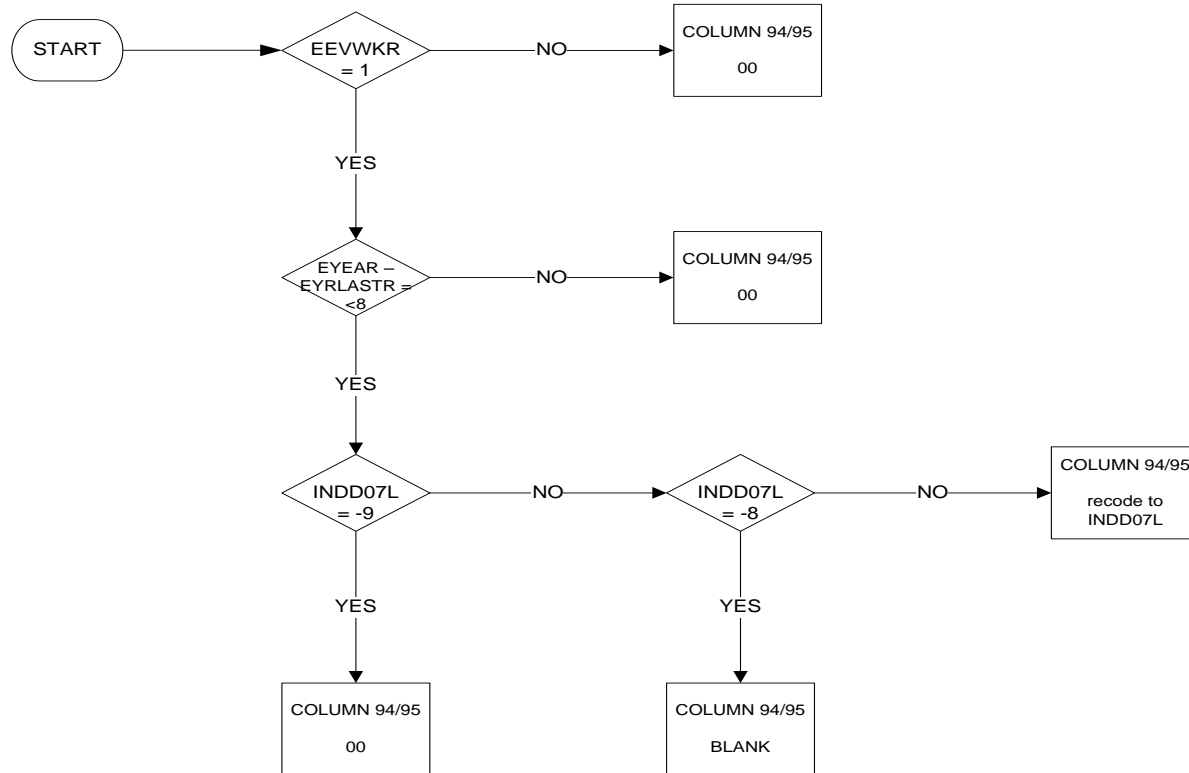

KEY	
	NACE Rev. 2
00	Not applicable (col 84 = 0, 9, BLANK or col 84 = 1 and did not work in last eight years)
Blank	No answer

ISCOPR3D (EISCOLR): Occupation of last job

Columns 96/98

PAGE 1 OF 1

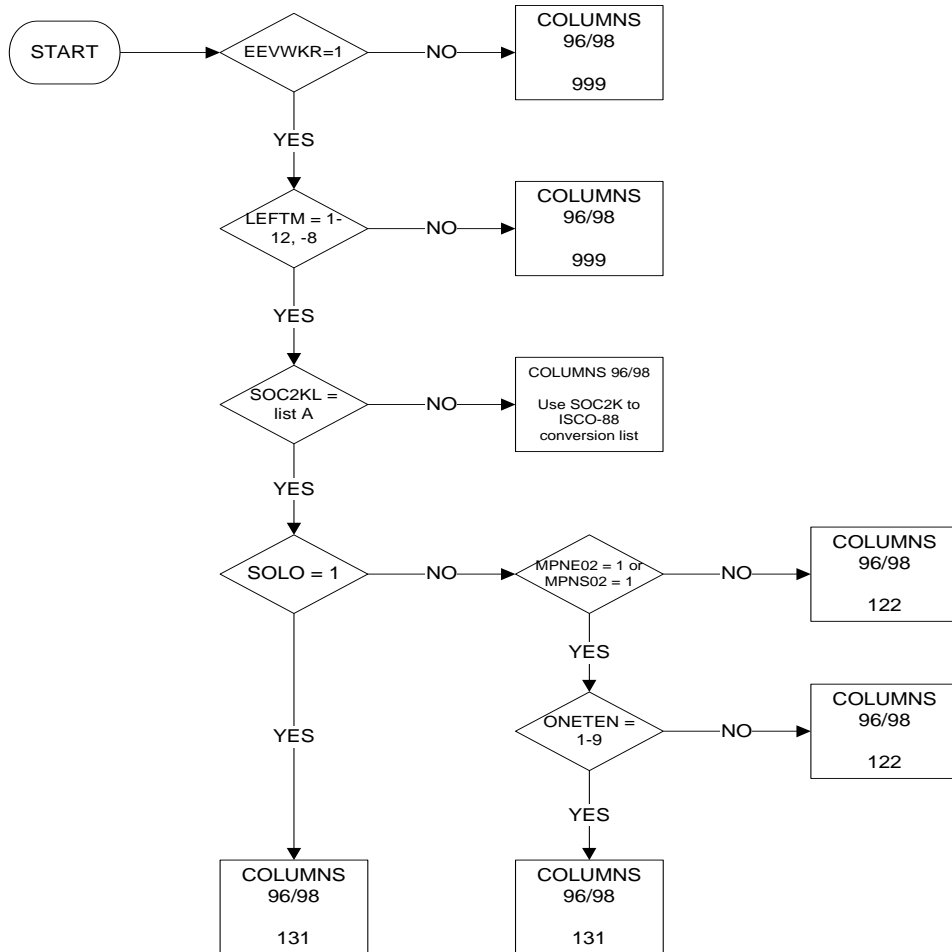

KEY	
999	Not applicable (EXISTPR = 0, 9, BLANK or EXISTPR = 1 and did not work in last 8 years)
BLANK	No answer
Notes	
List A= 1121, 1122, 1151, 1222, 1231, 1161, 1162, 1226, 1163, 1232, 1182, 1183, 1225, 1235, 1239, 1185, 1233, 1211, 1212, 1219, 1221, 1223, 1224	

SEEKWORK (ELOOKR): Seeking employment during previous four weeks

Column 99
PAGE 1 OF 1

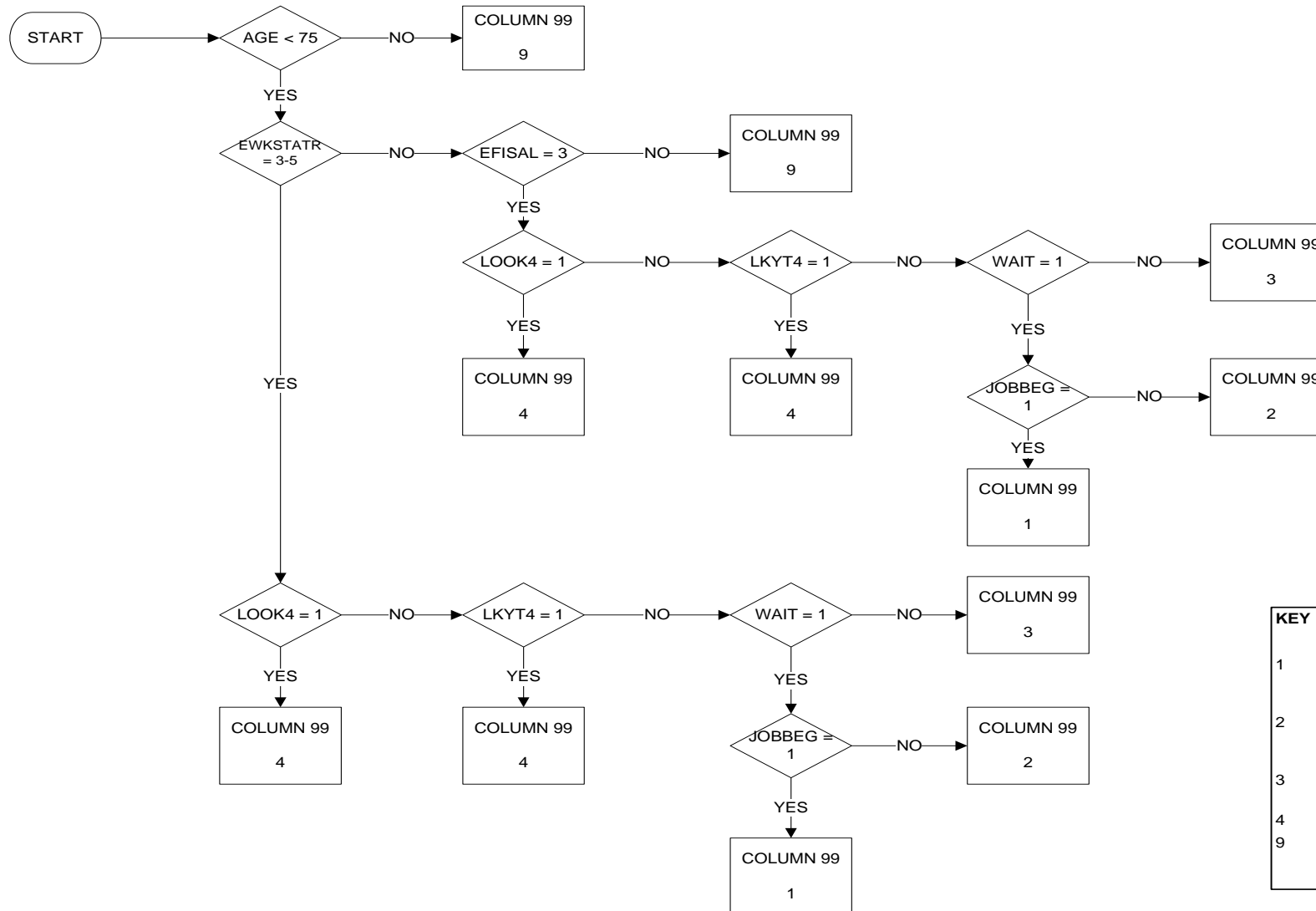

KEY	
1	Person has already found a job which will start within a period of at most 3 months
2	Person has already found a job which will start in more than 3 months and is not seeking employment
3	Person is not seeking employment and has not found any job to start later
4	Person is seeking employment
9	Not applicable (WSTATOR = 1, 2 or 9 and SIGNISAL ? 3) or Age = 75

SEEKWORK (ENOLWM): Reasons for not seeking employment

Column 100
PAGE 1 OF 1

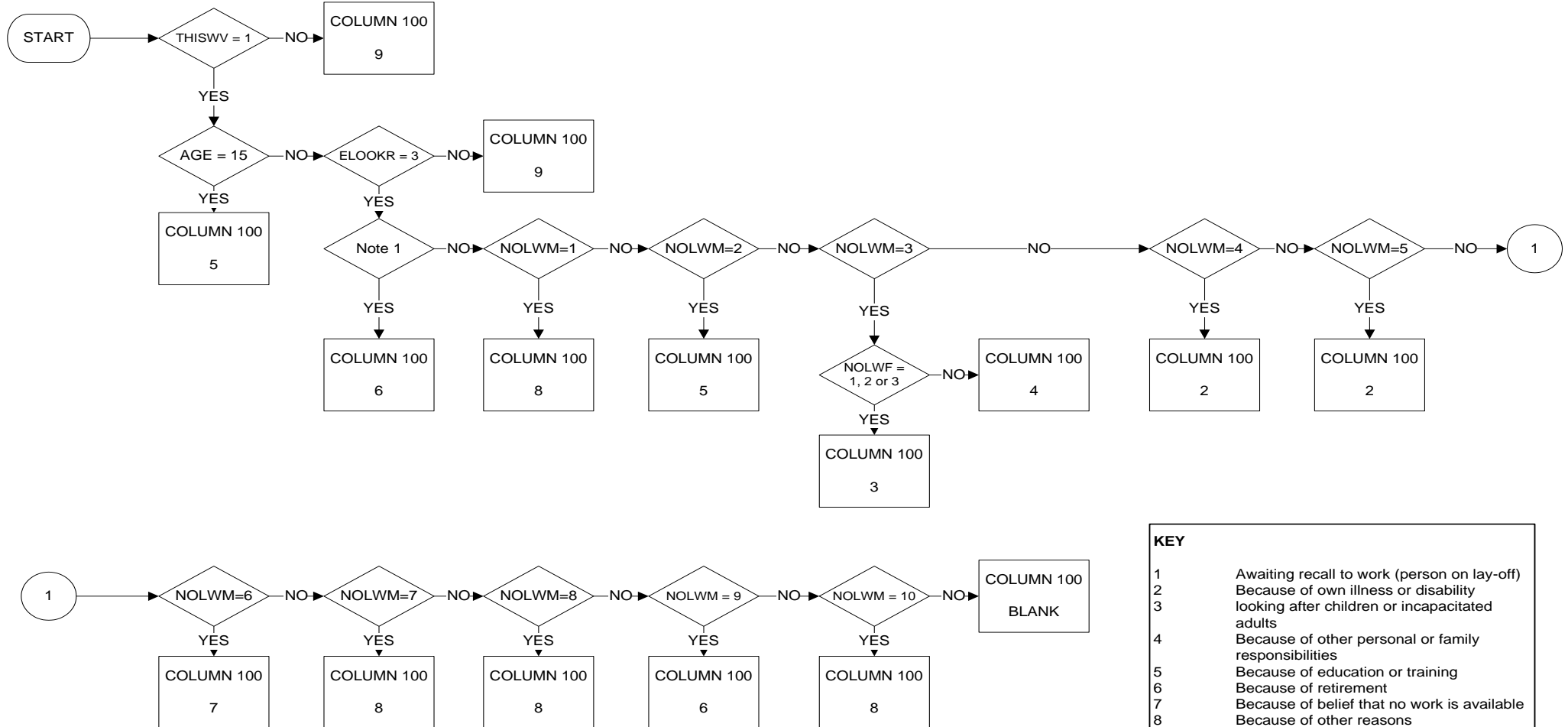

KEY	
1	Awaiting recall to work (person on lay-off)
2	Because of own illness or disability
3	looking after children or incapacitated adults
4	Because of other personal or family responsibilities
5	Because of education or training
6	Because of retirement
7	Because of belief that no work is available
8	Because of other reasons
9	Not applicable (SEEKWORK ? 3)
BLANK	No answer

Note 1:
(SEX=1 & AGE>=70) or (SEX=2 & AGE>=65)

SEEKTYPE (ETYMP SR): Type of employment sought (or found)

Column 101
PAGE 1 OF 2

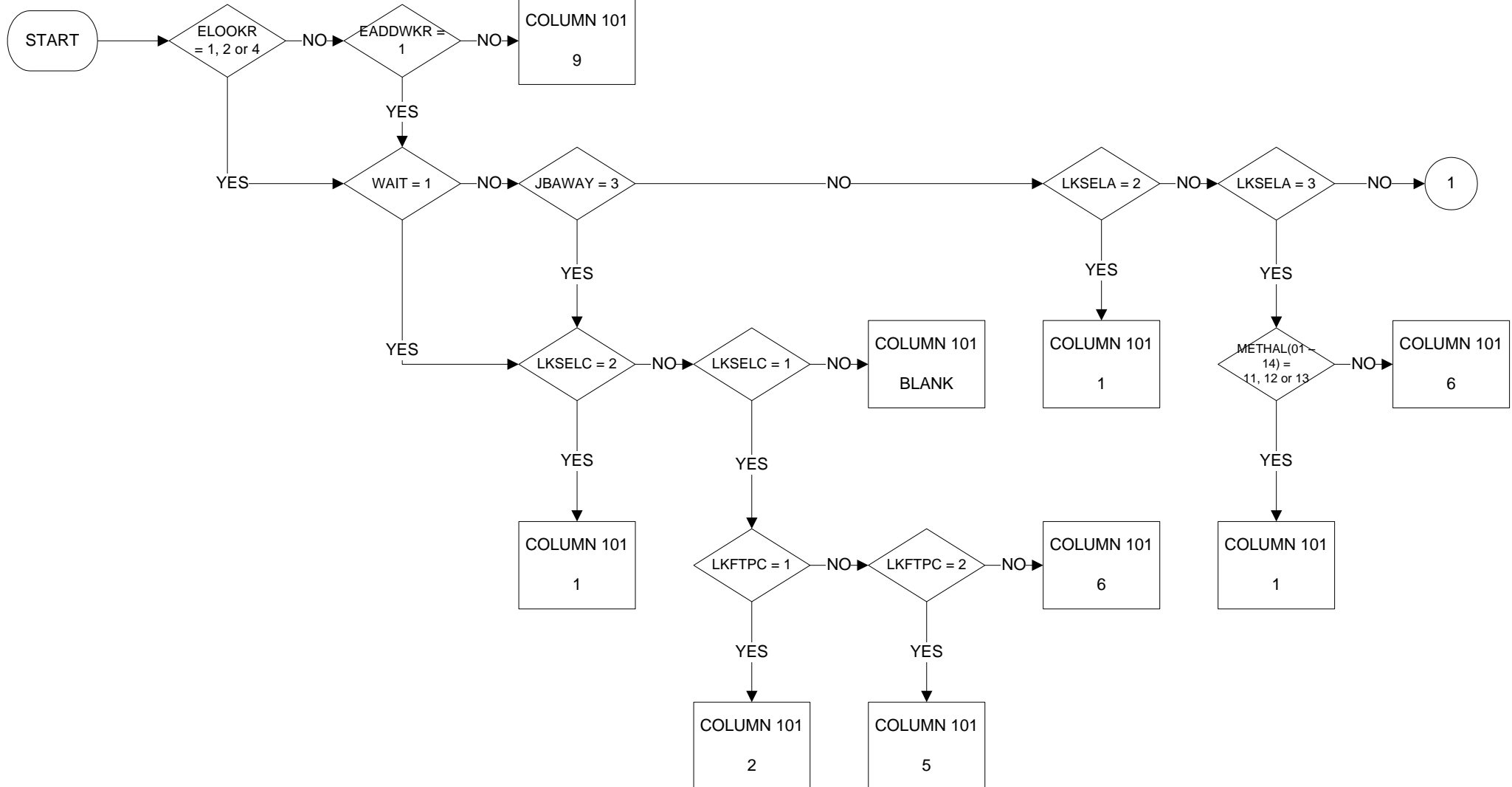

SEEKTYPE (ETYMPSR): Type of employment sought (or found)

Column 101
PAGE 2 OF 2

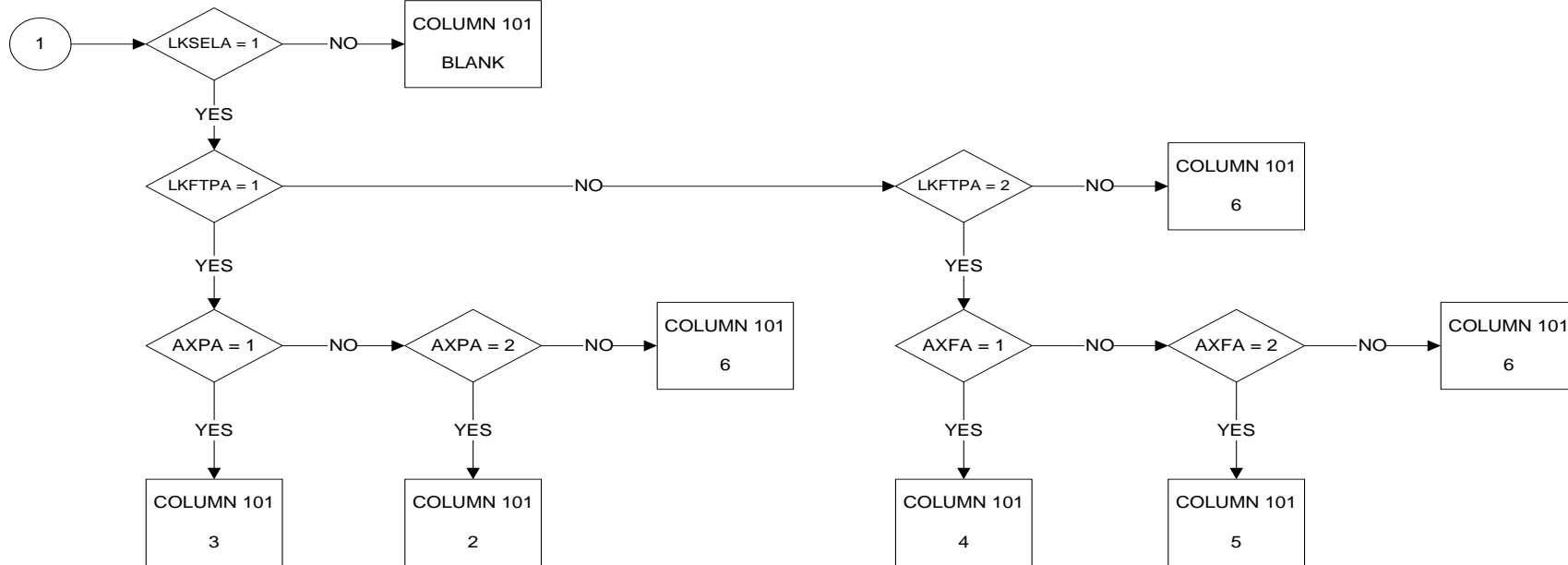

KEY

- 1 As self-employed
- As Employee:
- 2 Only full time is looked for (or has already been found)
- 3 Full time job is sought, but if not available, part time job will be accepted
- 4 Part time job is sought, but if not available, full time job will be accepted
- 5 Only part time job is looked for (or has already been found)
- 6 Person did not state whether full time or part time job is looked for (or has already been found)
- 9 Not applicable (SEEKWORK ? 1, 2, 4 and LOOKOJ ? 1)
- BLANK No Answer

SEEKDUR (ELKTIMR): Duration of search for employment

Column 102
PAGE 1 OF 2

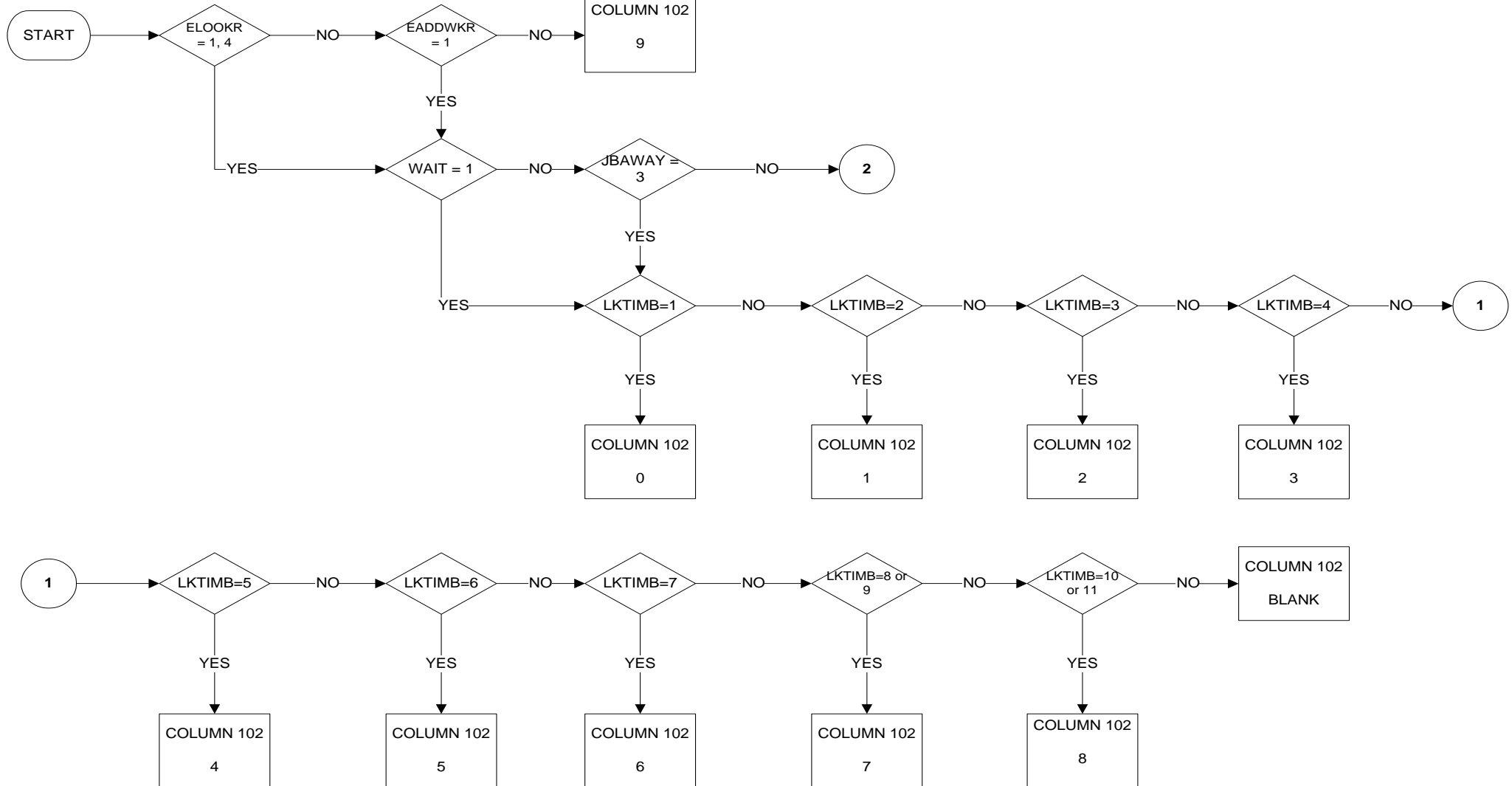

SEEKDUR (ELKTIMR): Duration of search for employment

Column 102

PAGE 2 OF 2

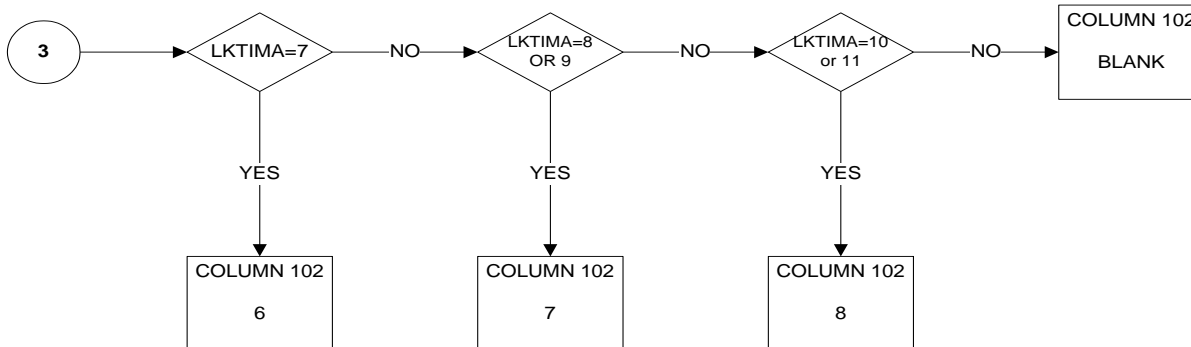
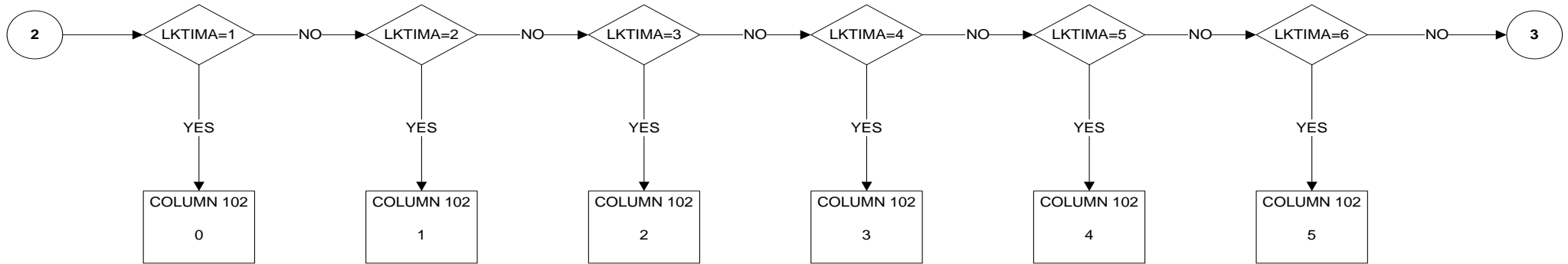

KEY	
0	Search not yet started
1	Less than 1 month
2	1-2 months
3	3-5 months
4	6-11 months
5	12-17 months
6	18-23 months
7	24-47 months
8	4 years or longer
9	Not applicable (SEEKWORK ? 1, 4 and LOOKOJ ? 1)
BLANK	No answer

METHODA (EMETH1R): Contacted public employment office to find work

Column 103

PAGE 1 OF 1

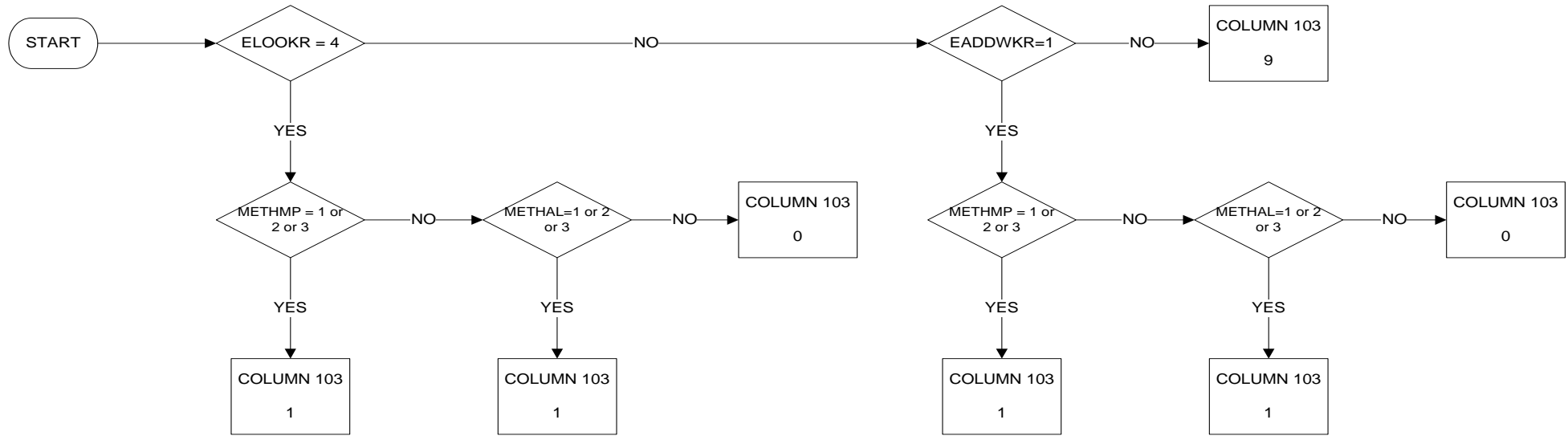

KEY	
0	No
1	Yes
9	Not applicable (SEEKWORK ? 4 and LOOKOJ ? 1)

METHODB (EMETH2R): Contacted private employment agency to find work

Column 104
PAGE 1 OF 1

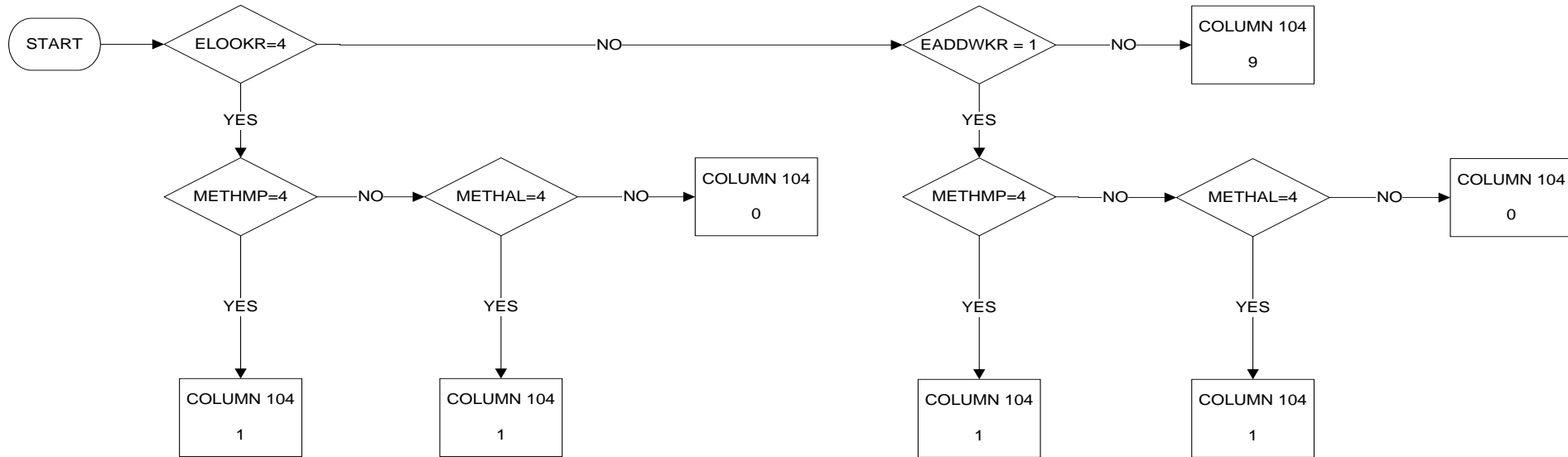

KEY	
0	No
1	Yes
9	Not applicable (SEEKWORK ? 4 and LOOKOJ ? 1)

METHODC (EMETH3R): Applied to employers directly

Column 105

PAGE 1 OF 1

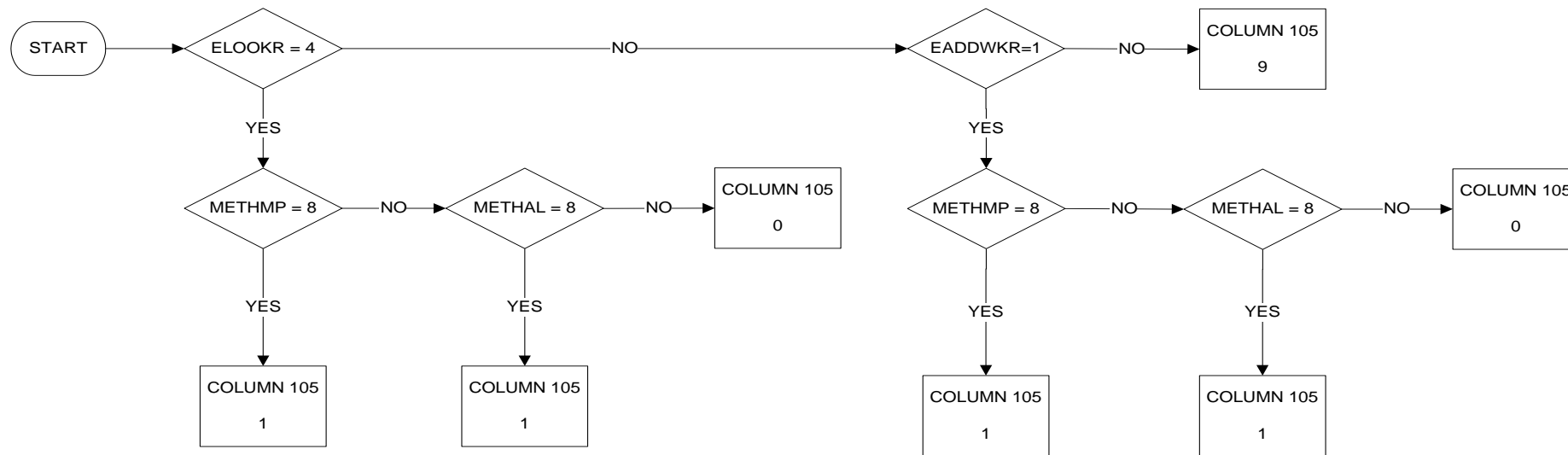

KEY	
0	No
1	Yes
9	Not applicable (SEEKWORK ? 4 and LOOKOJ ? 1)

METHODD (EMETH4R): Asked friends, relatives, trade unions etc
 Column 106
 PAGE 1 OF 1

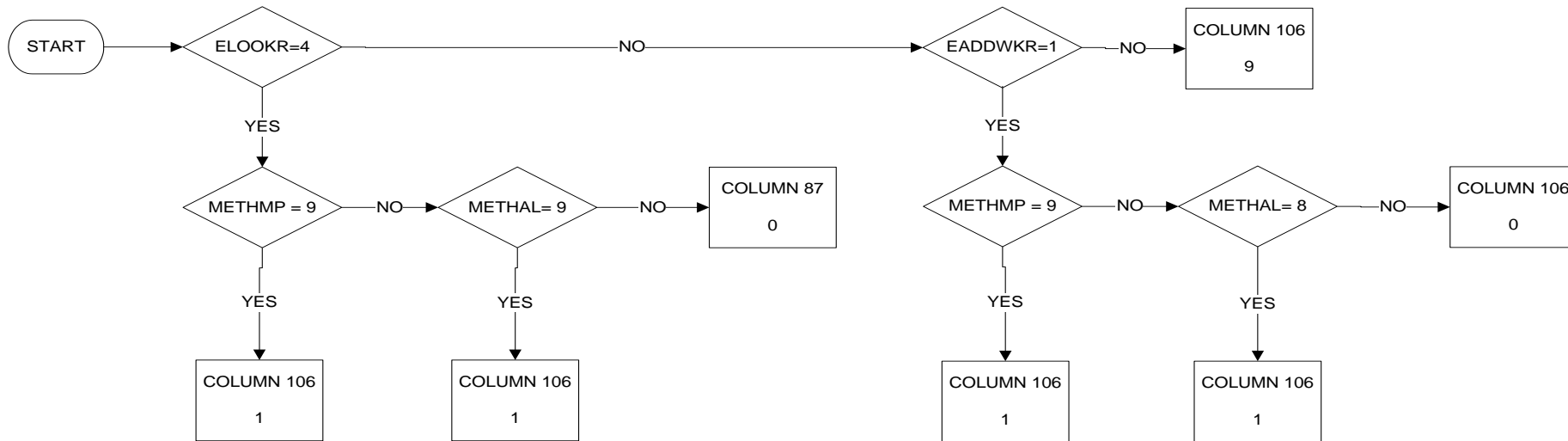

KEY	
0	No
1	Yes
9	Not applicable (SEEKWORK ? 4 and LOOKOJ ? 1)

METHODE (EMETH5R): Inserted or answered adverts in newspapers or journals

Column 107
PAGE 1 OF 1

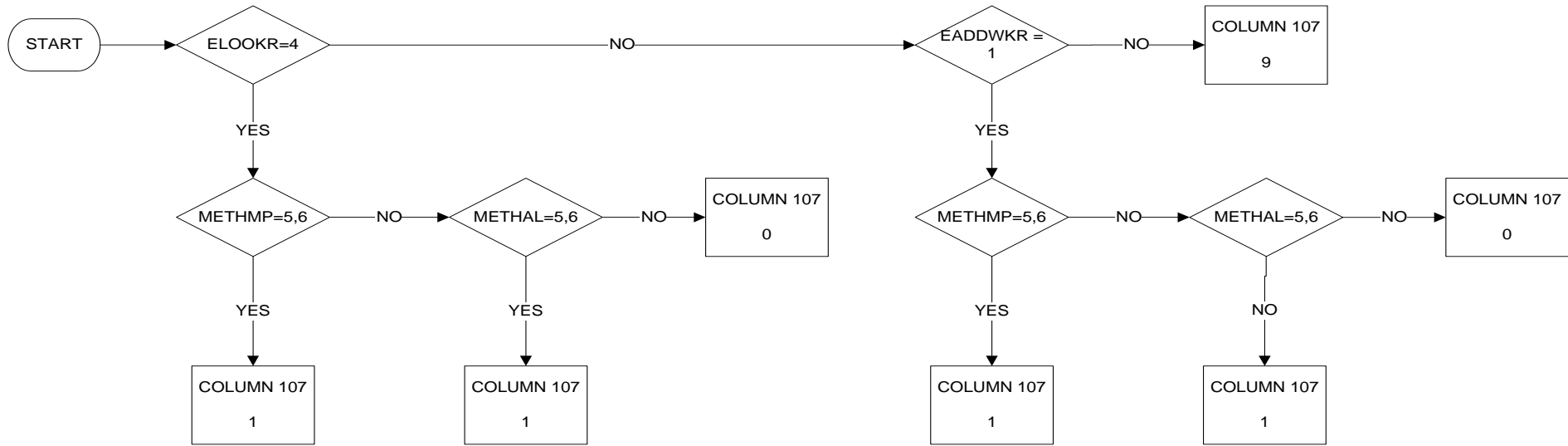

KEY	
0	No
1	Yes
9	Not applicable (SEEKWORK ? 4 and LOOKOJ ? 1)

METHODF (EMETH6R): Studied adverts in newspapers or journals

Column 108

PAGE 1 OF 1

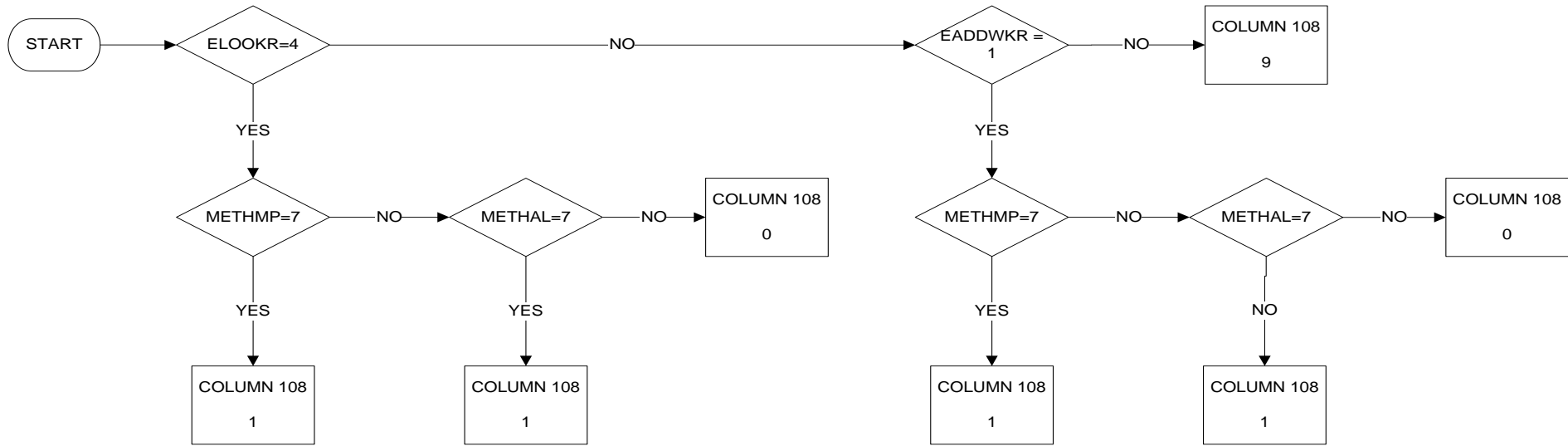

KEY	
0	No
1	Yes
9	Not applicable (SEEKWORK ? 4 and LOOKOJ ? 1)

METHODG (EMETH7R): Took a test, interview or examination

Column 109

PAGE 1 OF 1

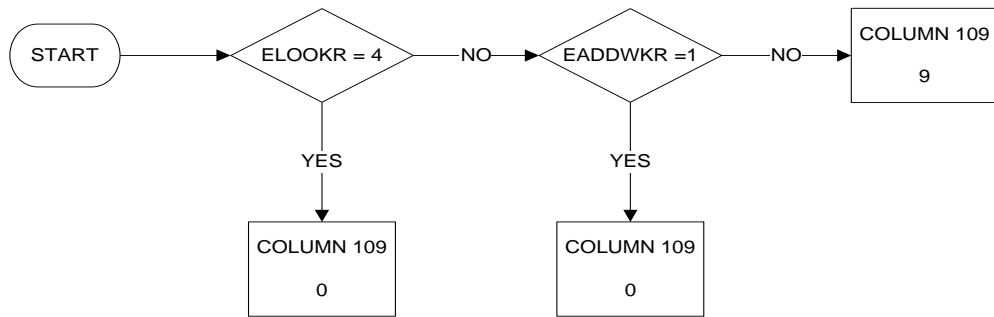

KEY

0	No
1	Yes
9	Not applicable (SEEKWORK ? 4 and LOOKOJ ? 1)

Notes

An answer of No (0) is given for all respondents as taking a test, interview or examination as a method of FINDING work is not used in the UK.

METHODH (EMETH8R): Looked for land, premises or equipment

Column 110
PAGE 1 OF 1

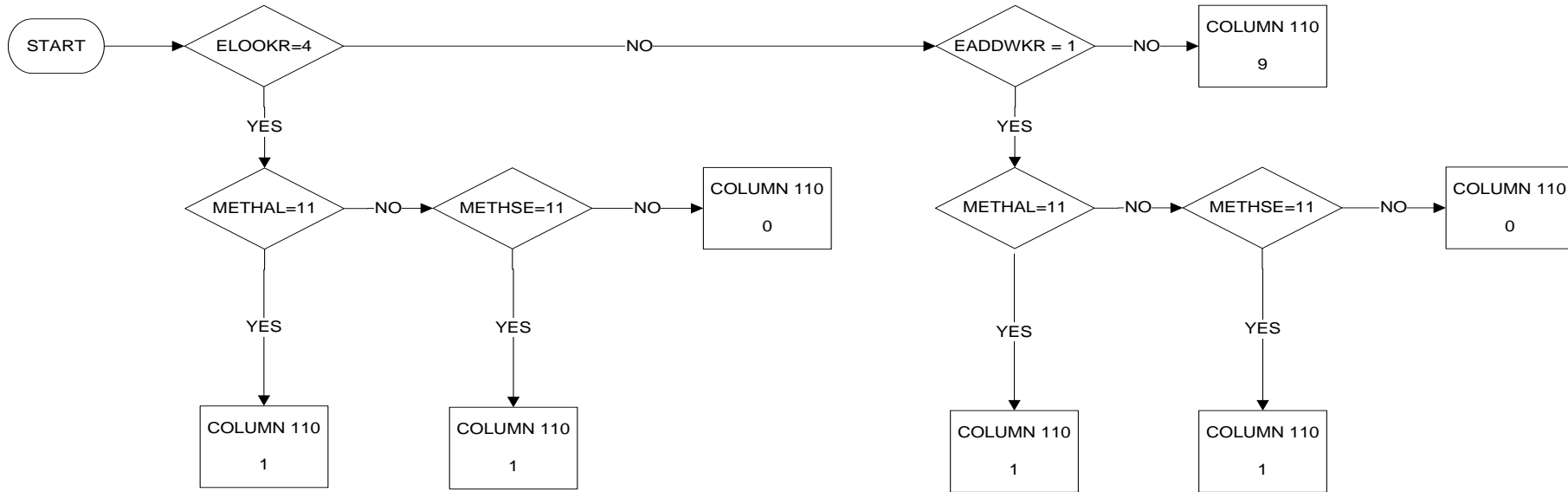

KEY	
0	No
1	Yes
9	Not applicable (SEEKWORK ? 4 and LOOKOJ ? 1)

METHODI (EMETH9R): Looked for permits, licenses or financial resources

Column 111

PAGE 1 OF 1

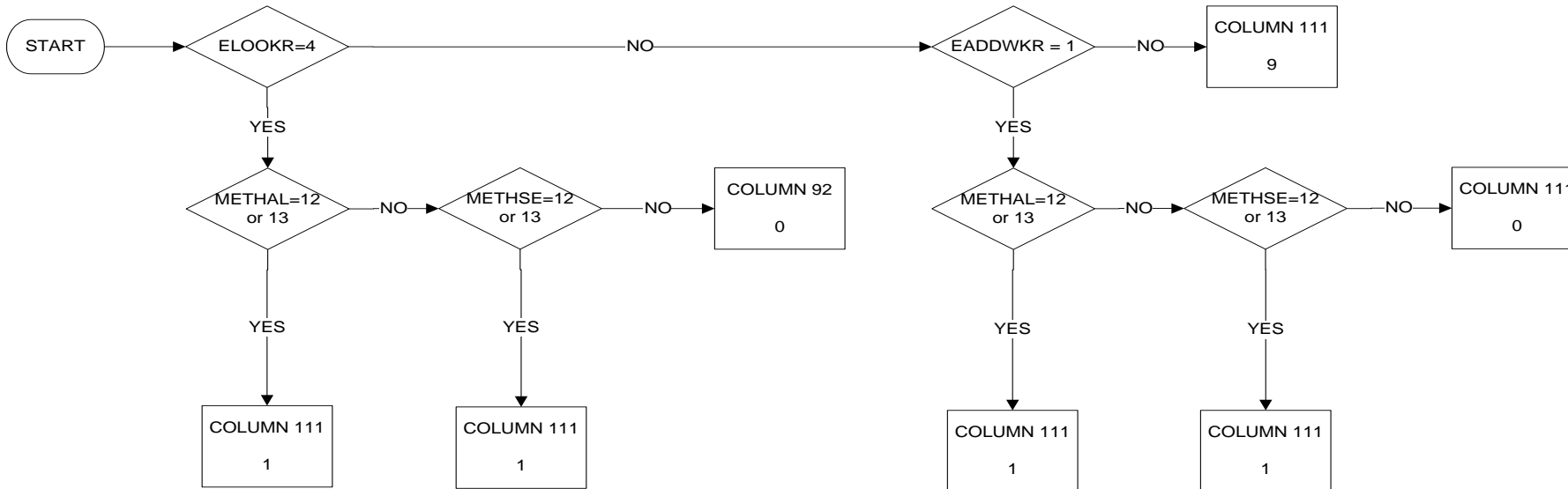

KEY	
0	No
1	Yes
9	Not applicable (SEEKWORK ? 4 and LOOKOJ ? 1)

METHODJ (EMETH10R): Awaiting results of job application

Column 112

PAGE 1 OF 1

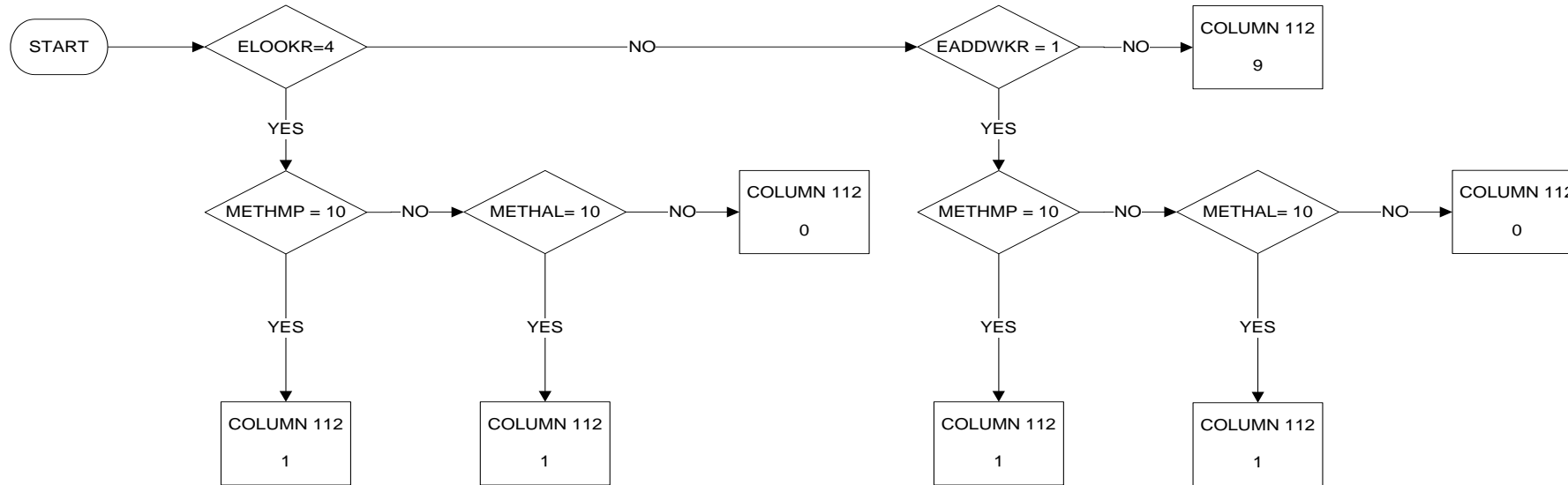

KEY	
0	No
1	Yes
9	Not applicable (SEEKWORK ? 4 and LOOKOJ ? 1)

METHODK (EMETH11R): Waiting for a call from a public employment office

Column 113

PAGE 1 OF 1

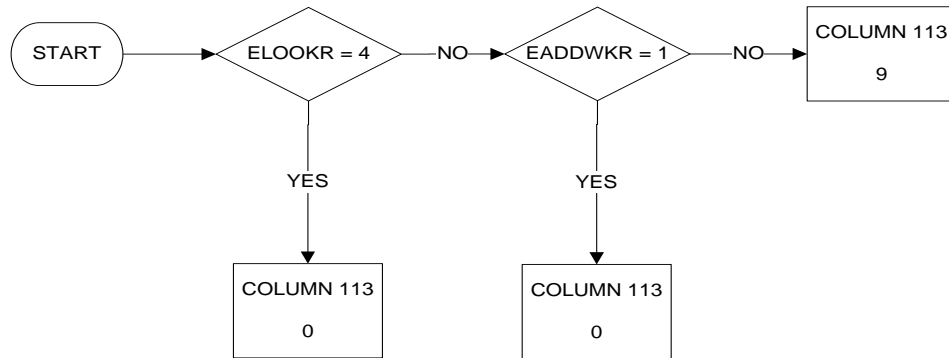

KEY

0 No
 1 Yes
 9 Not applicable (SEEKWORK ? 4 and LOOKOJ ? 1)

Notes

An answer of No (0) is given for all respondents as taking a test, interview or examination as a method of FINDING work is not used in the UK.

METHODL (EMETH12R): Awaiting results of a competition for recruitment to public sector

Column 114

PAGE 1 OF 1

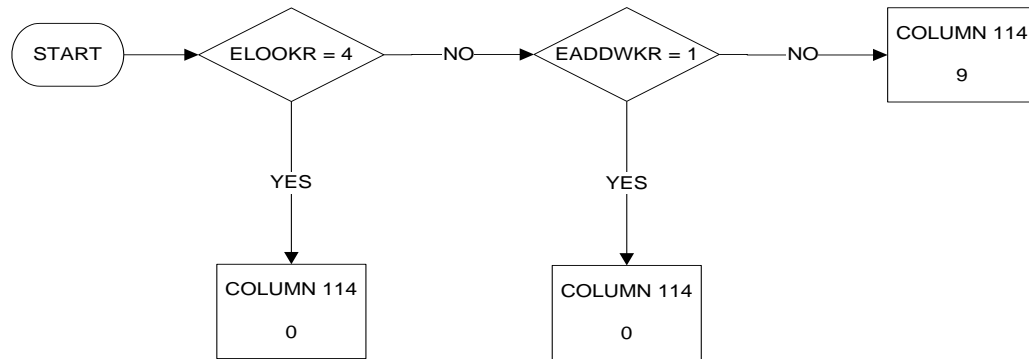

KEY

0	No
1	Yes
9	Not applicable (SEEKWORK ? 4 and LOOKOJ ? 1)

Notes

An answer of No (0) is given for all respondents as taking a test, interview or examination as a method of FINDING work is not used in the UK.

METHODM (EMETH13R): Other job search method used

Column 115

PAGE 1 OF 1

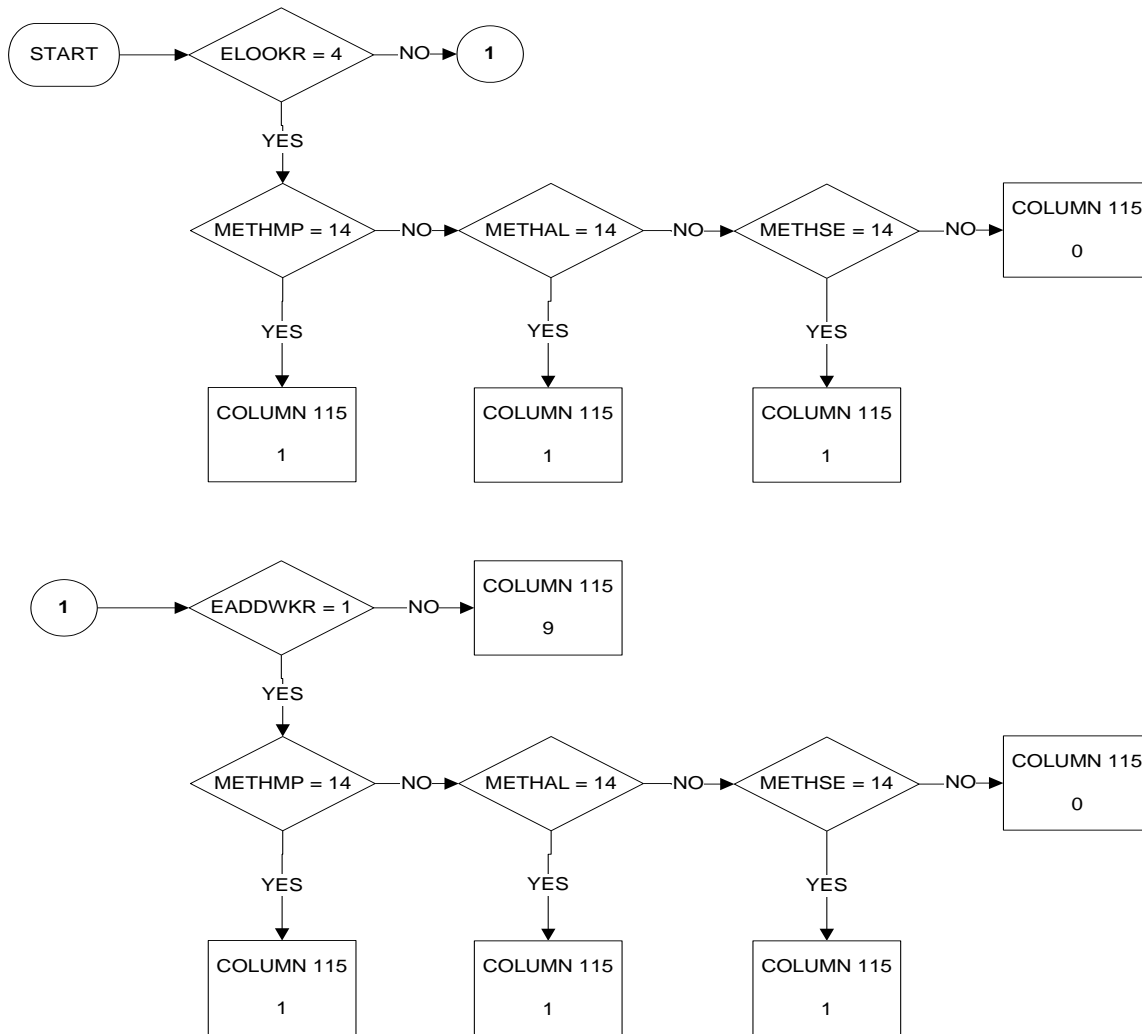

KEY	
0	No
1	Yes
9	Not applicable (SEEKWORK ? 4 and LOOKOJ ? 1)

WANTWORK (ELIKWKR): Willingness to work for person not seeking employment

Column 116
PAGE 1 OF 1

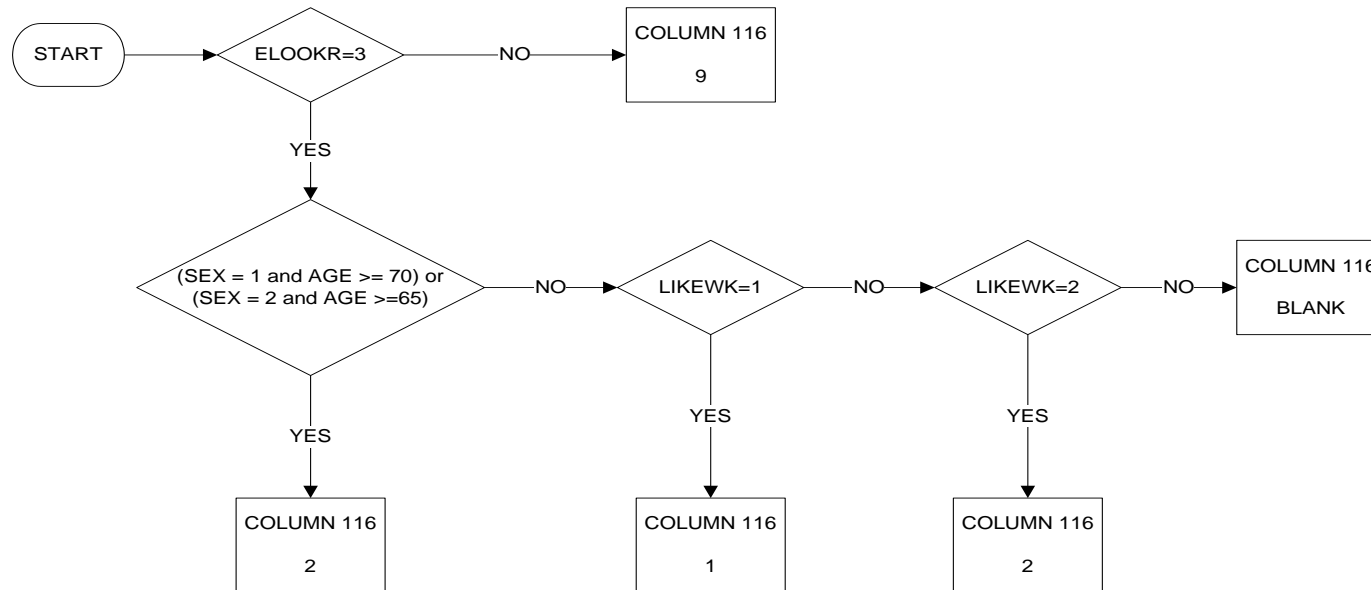

KEY	
1	But would nevertheless like to have work
2	And does not want to have work
9	Not applicable (SEEKWORK = 3)
BLANK	No answer

AVAILABLE (EVALWKR): Availability to start work within two weeks

Column 117

PAGE 1 OF 1

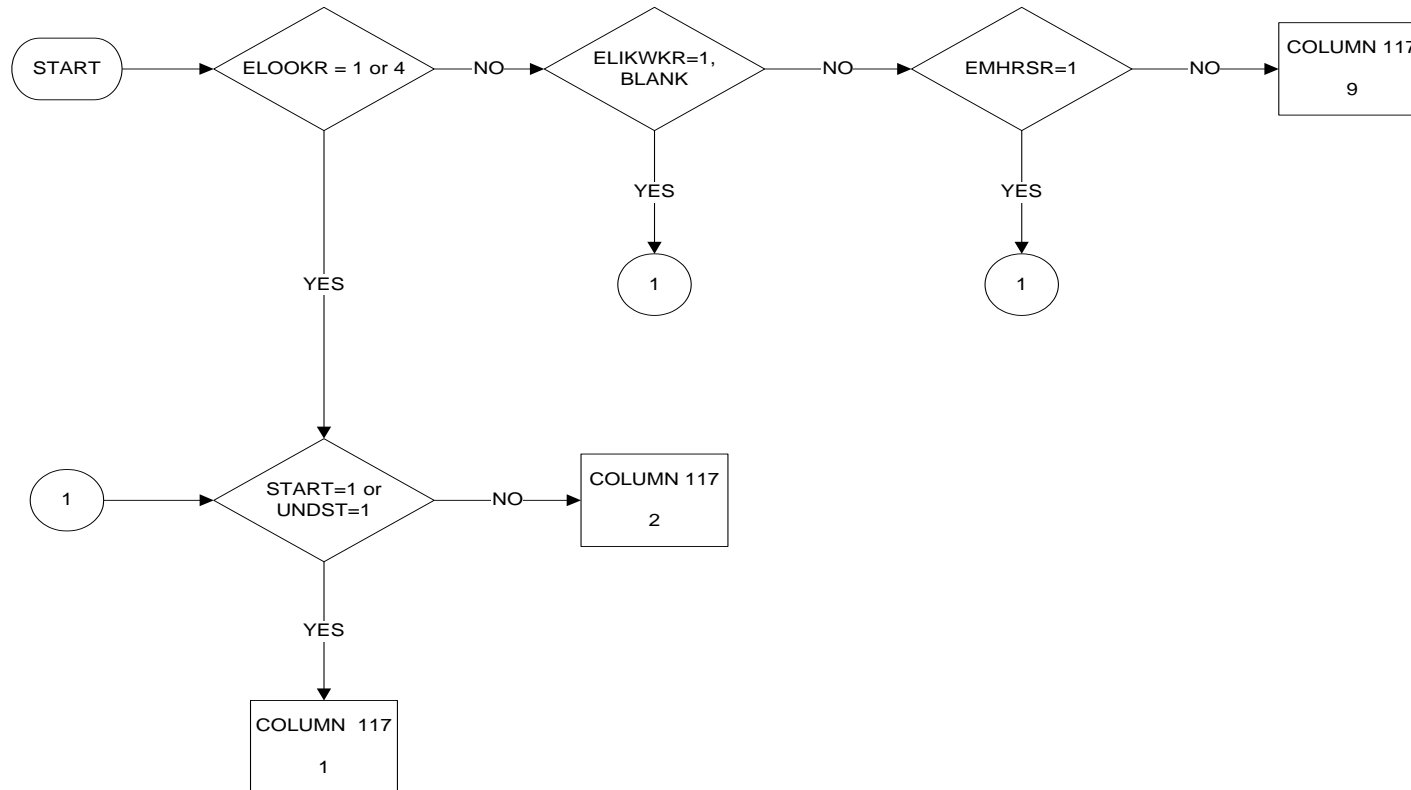

KEY

- 1 Person could start to work immediately (within 2 weeks)
- 2 Person could not start to work immediately (within 2 weeks)
- 9 Not applicable (SEEKWORK ? 1, 4 and WANTWORK ? 1, BLANK and WISHMORE ? 1)

AVAIRES (EVALREA): Reasons for not being available to start work within two weeks

Column 118

PAGE 1 OF 1

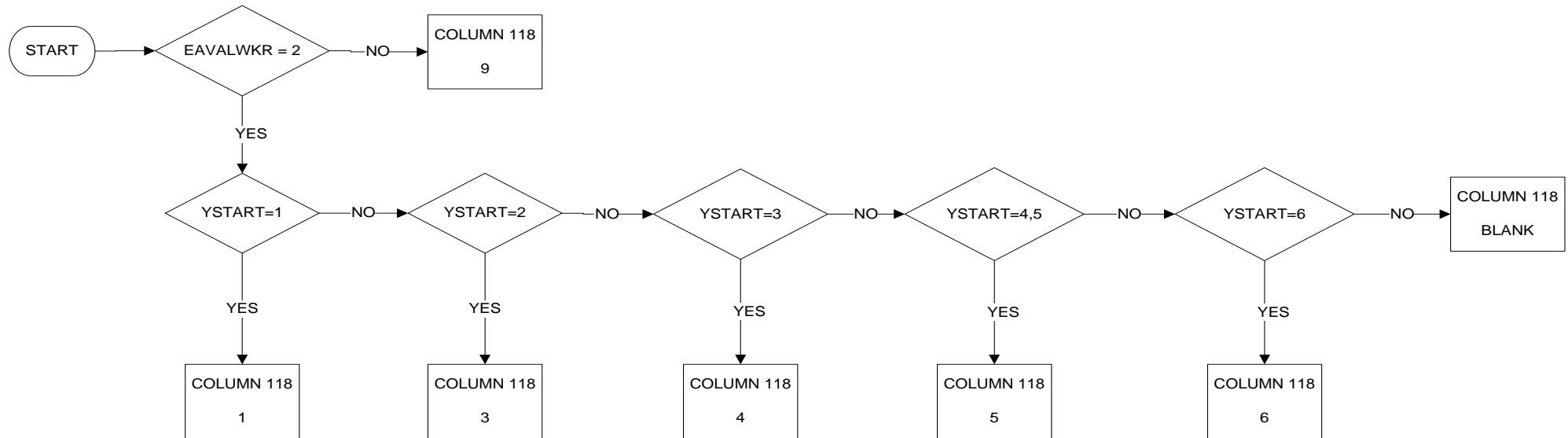

KEY

- 1 He/she must complete education or training
- 2 He/she must complete compulsory military or community service
- 3 He/she cannot leave present employment within two weeks due to period of notice
- 4 Of personal or family responsibilities (including maternity)
- 5 Of own illness or incapacity
- 6 Of other reasons
- 9 Not applicable (AVAILBLE ? 2)
- BLANK No answer

PRESEEK (EBEFORER): Situation immediately before seeking work

Column 119
PAGE 1 OF 1

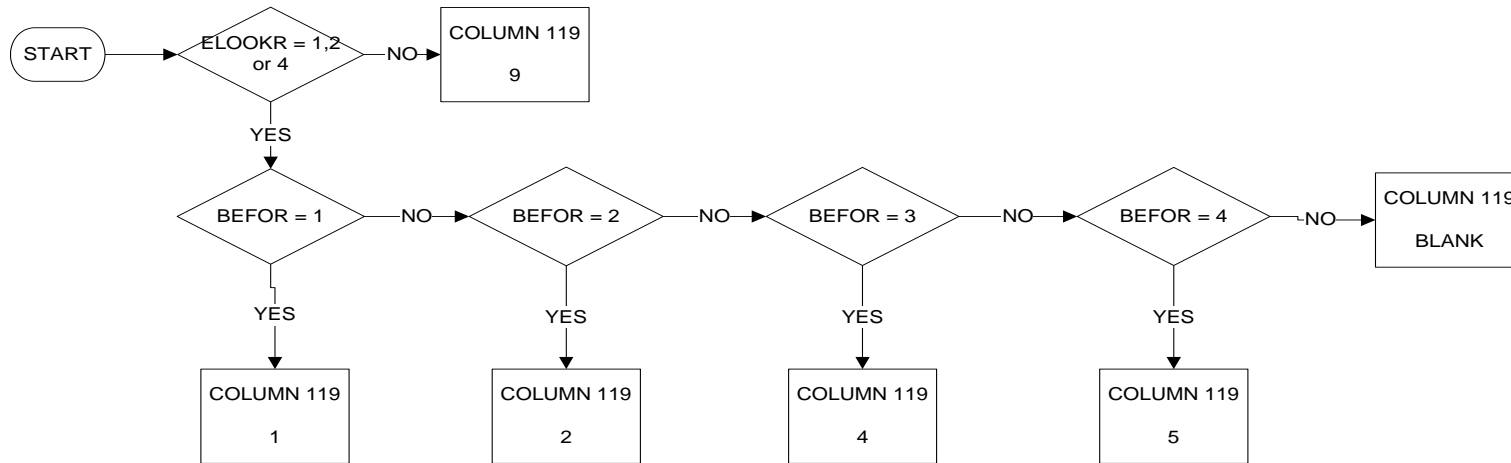

KEY

- 1 Person was working (including apprentices, trainees)
- 2 Person was in full-time education (excluding apprentices, trainees)
- 3 Person was conscript on compulsory military or community service
- 4 Person had domestic/family responsibilities
- 5 Other (e.g. retired)
- 9 Not applicable (SEEKWORK =3,9)
- BLANK No answer

ENECARE: Need for care facilities

Column 120

PAGE 1 OF 1

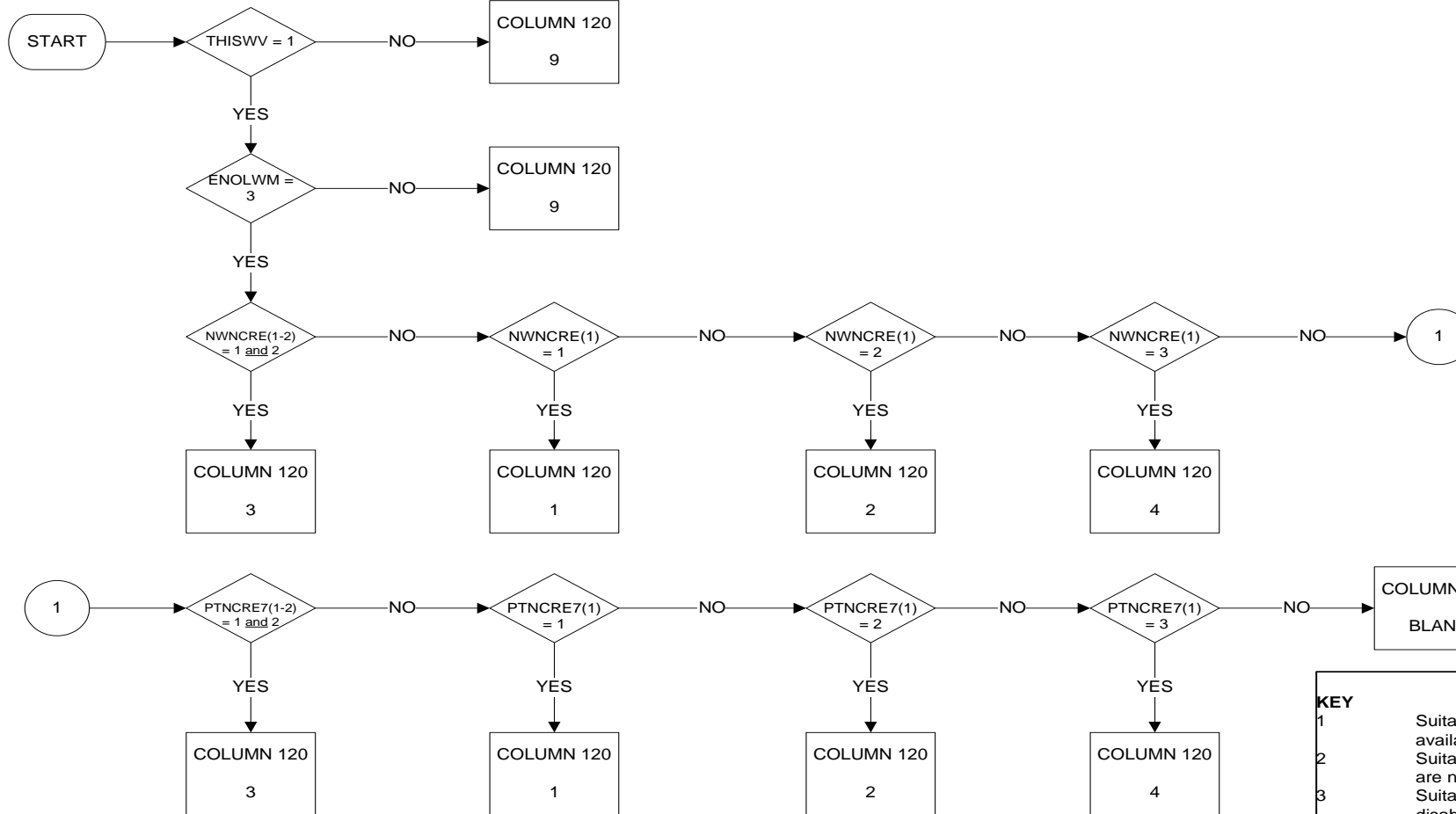

KEY

- 1 Suitable care services for children are not available or affordable
- 2 Suitable care services for ill, disabled, elderly are not available or affordable
- 3 Suitable care services for both children and ill, disabled and elderly are not available or affordable
- 4 Care facilities do not influence decision for working part time or not searching for a job
- 9 Not applicable (ENOLWM NE 3 or THISWV NE 1)
- Blank No answer

REGISTER (EREGPUB): Registration at a Public Employment Office

Column 121

PAGE 1 OF 1

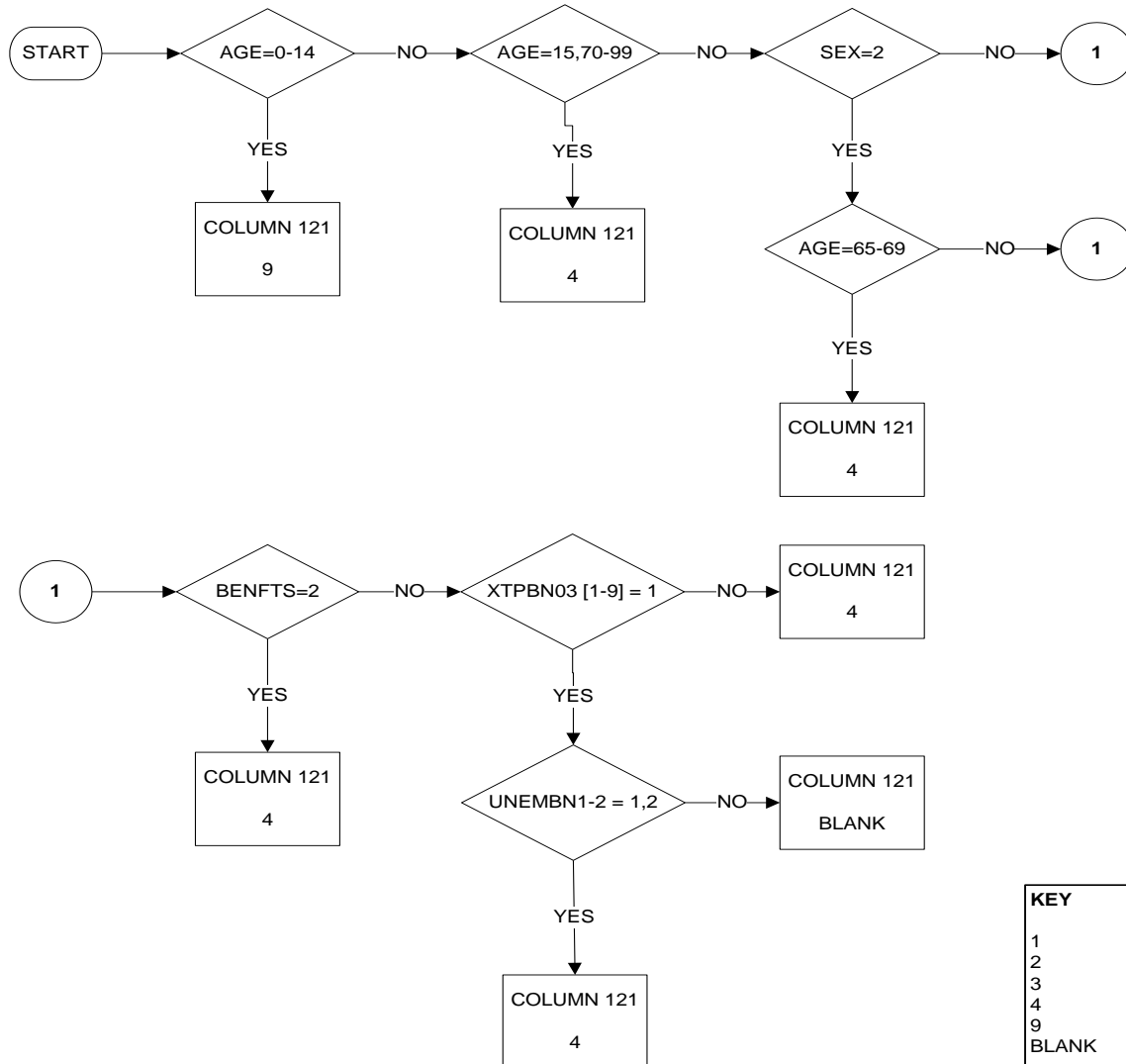

KEY

- 1 Person is registered at a public employment office and receives benefit or assistance
- 2 Person is registered at a public employment office but does not receive benefit or assistance
- 3 Person is not registered at a public employment office but receives benefit or assistance
- 4 Person is not registered at a public employment office and does not receive benefit or assistance
- 9 Not applicable (person aged less than 15 years or older than 75)
- BLANK No answer

EDUCSTAT (EDUCSTA): Student or apprentice in regular education during last four weeks

Column 123

PAGE 1 OF 1

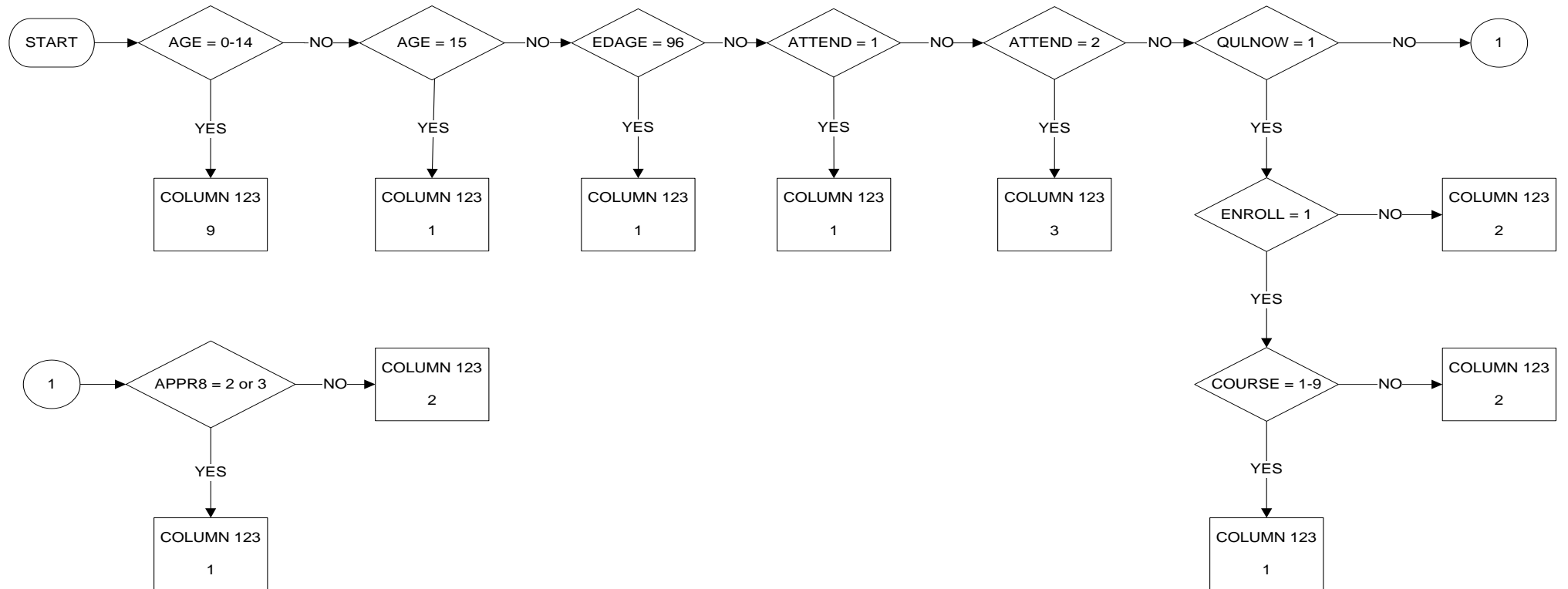

KEY

- 1 Has been a student or an apprentice
- 2 Has not been a student or apprentice
- 3 Person in regular education but on holidays
- 9 Not applicable (child less than 15 years)
- BLANK No answer

EDUCLEVEL (EDUCLEV) : Level of current education or training
Col 124

End date: 2013 Q4
From 2014 Q1 to 2014 Q4 see Col 209 EDUCLEVEL (EDUCLEV14)
From 2015 Q1 to 2015 Q4 see Col 209 EDUCLEVEL (EDUCLEV15)
From 2016 Q1 see Col 209 EDUCLEVEL (EDUCLEV16)

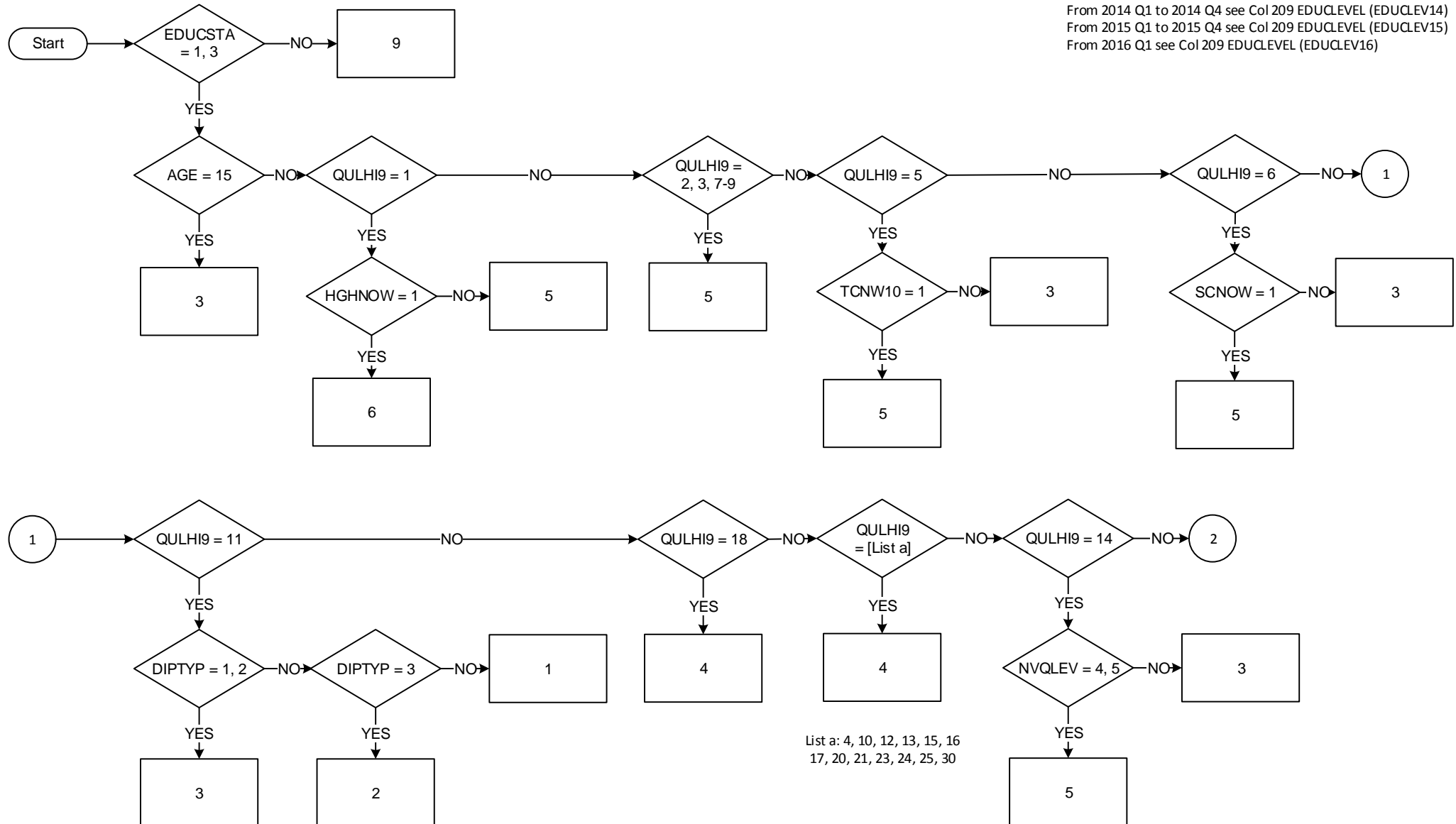

EDUCLEVEL (EDUCLEV) : Level of current education or training
Col 124

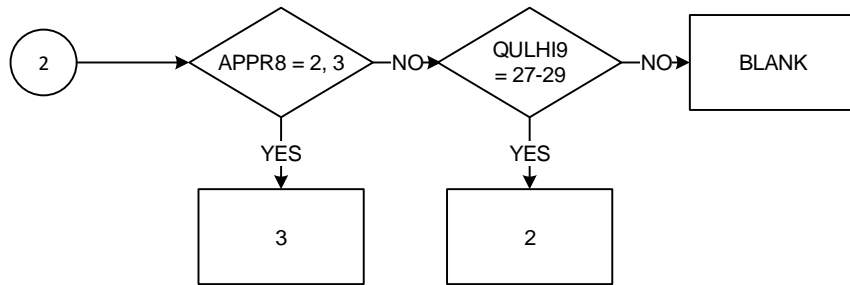

End date: 2013 Q4
From 2014 Q1 to 2014 Q4 see Col 209 EDUCLEVEL (EDUCLEV14)
From 2015 Q1 to 2015 Q4 see Col 209 EDUCLEVEL (EDUCLEV15)
From 2016 Q1 see Col 209 EDUCLEVEL (EDUCLEV16)

EDUCFILD (EDUCFLD): Field of this education or training

Columns 125/127

PAGE 1 OF 2

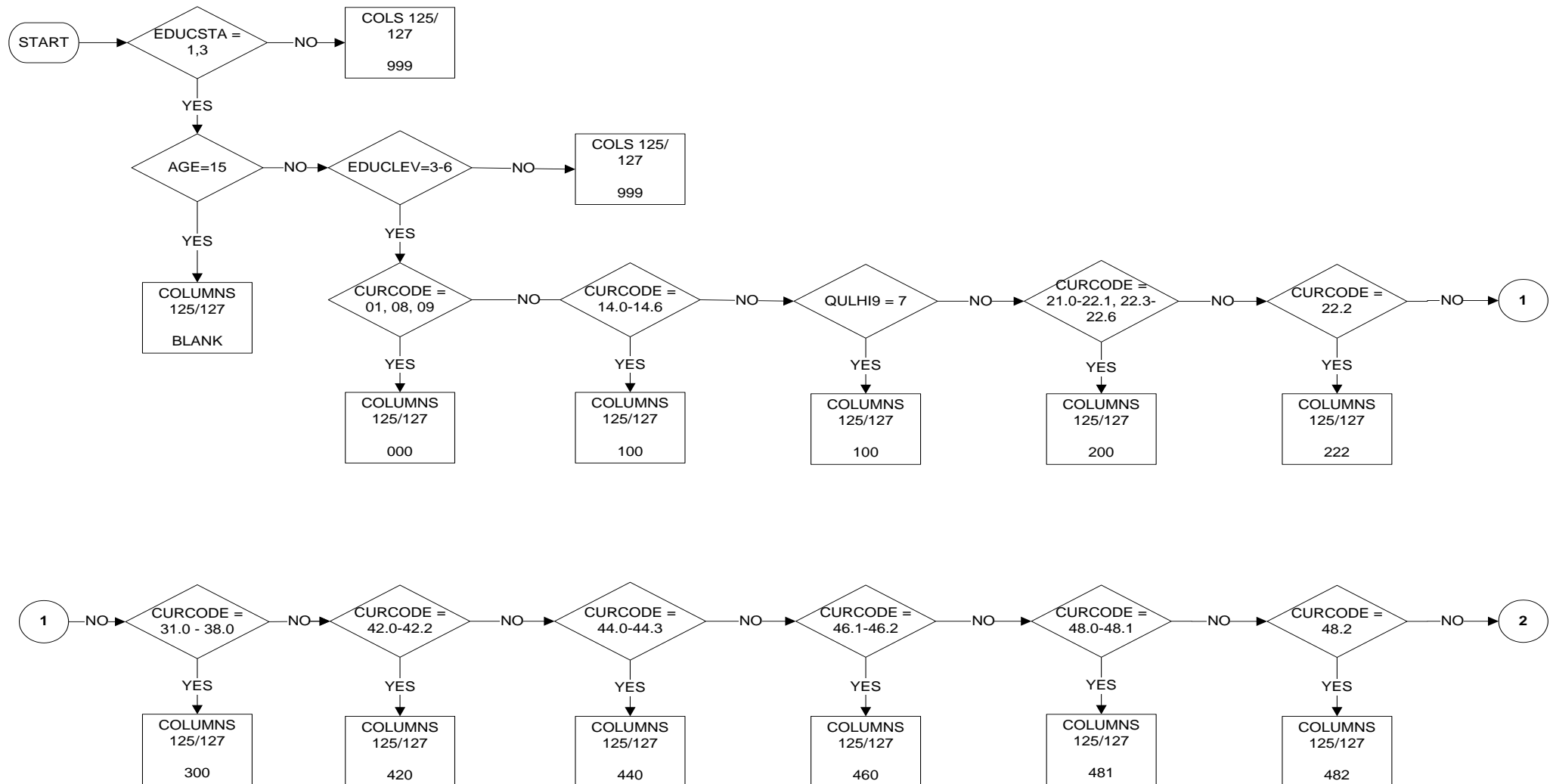

EDUCFIL (EDUCFLD): Field of this education or training

Columns 125/127

PAGE 2 OF 2

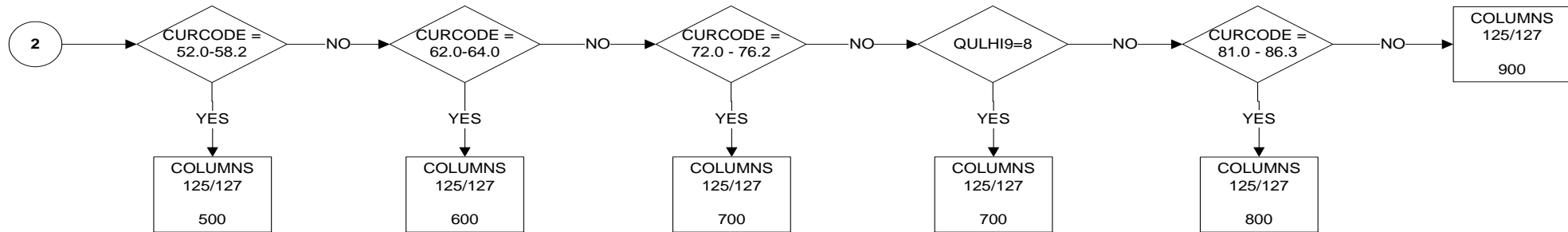

KEY

000	General programmes
100	Teacher training and education science
200	Humanities, language and arts
222	Foreign languages
300	Social science, business and law
400	Science, mathematics and computing
420	Life science (including biology and environmental science)
440	Physical science (including physics, chemistry and earth science)
460	Mathematics and statistics
481	Computer science
482	Computer use
500	Engineering, manufacturing and construction
600	Agriculture and veterinary
700	Health and welfare
800	Services
900	unknown
999	Not applicable (EDUCSTAT =2,9 BLANK or EDUCLEVL = 3-6)
BLANK	No answer

Notes

CURCODE values output as string not numeric, see attached coding frame

COURATT (ECOURA): Attendance at courses, seminars, private lessons etc outside regular education within last four weeks

Column 128

PAGE 1 OF 1

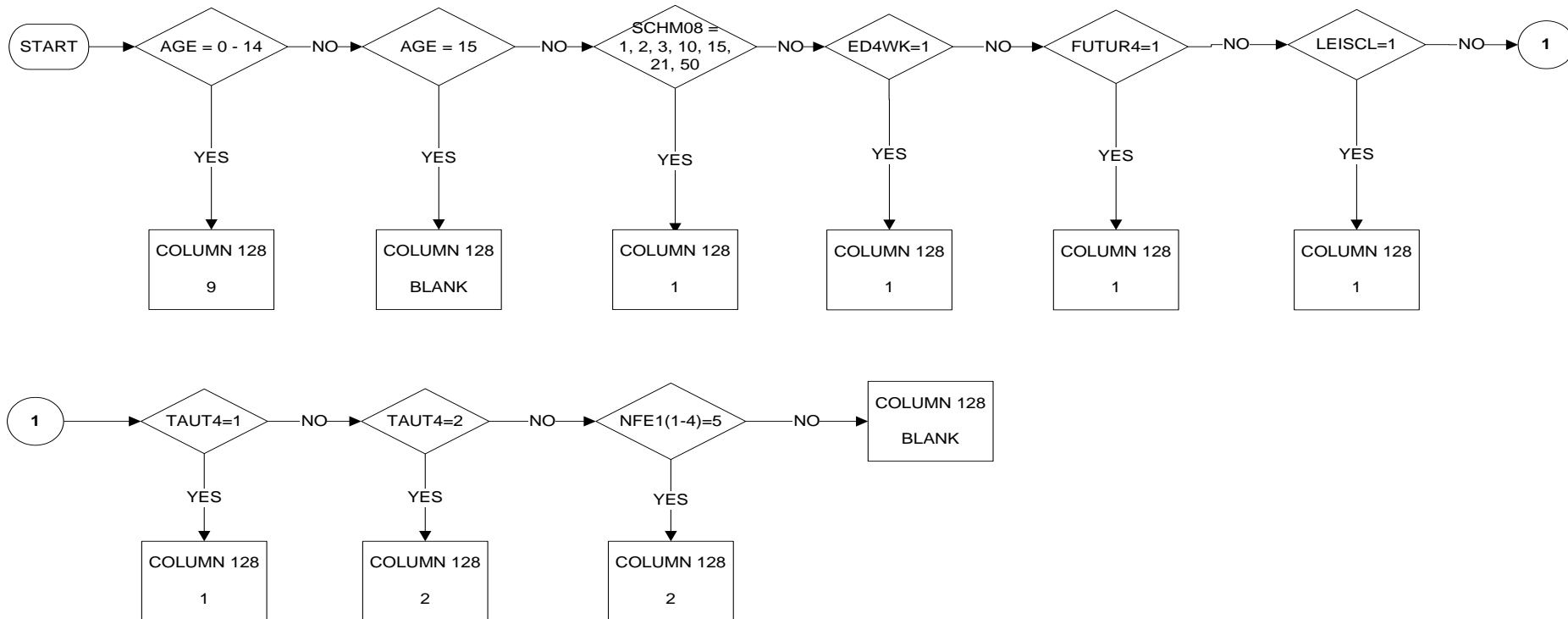

KEY	
1	Yes
2	No
9	Not applicable (child less than 15 years)
blank	No answer

COURATT (ECOURA16): Attendance at courses, seminars, private lessons etc outside regular education within last four weeks
Col. 128

Start date: 2016 Q1

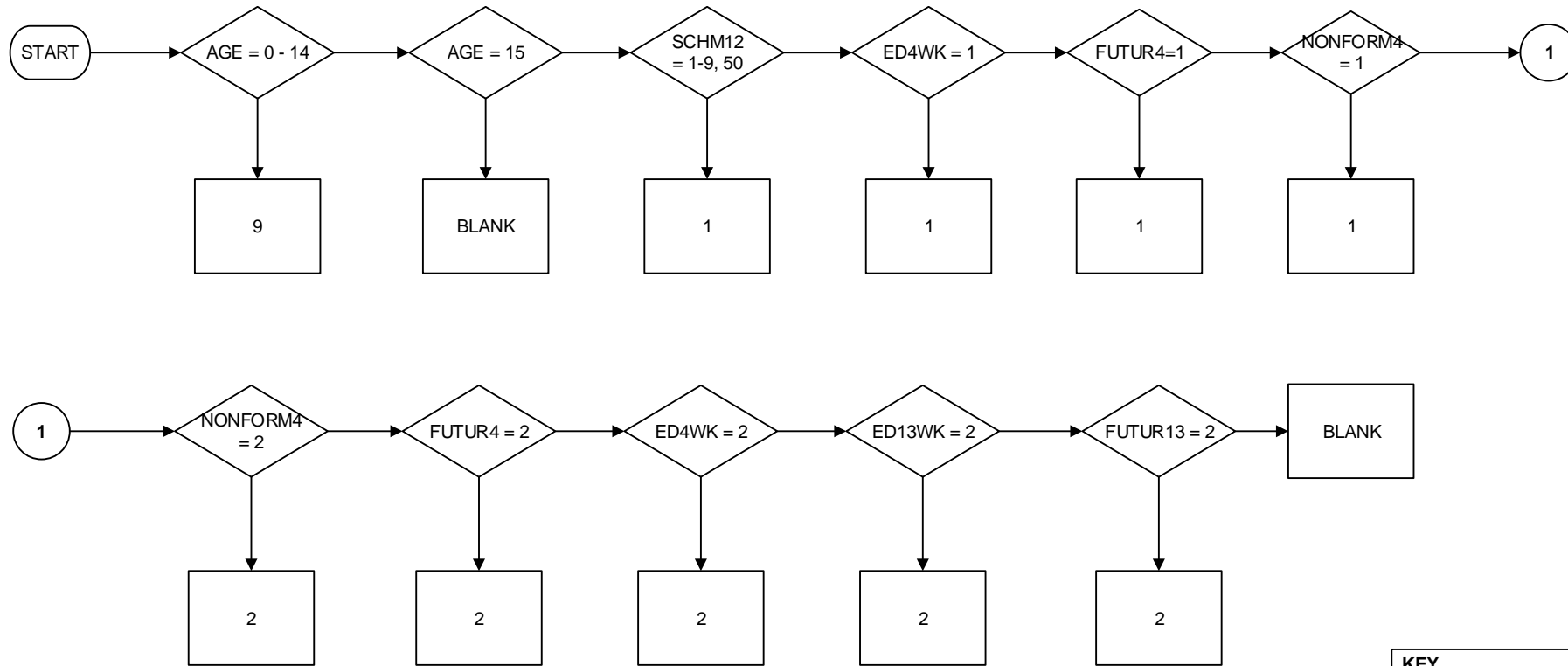

KEY	
1	Yes
2	No
9	Not applicable (child less than 15 years)
blank	No answer

COURLEN (ECOURL): Number of hours spent on all taught learning activities within the last four weeks

Columns 129/131

PAGE 1 OF 1

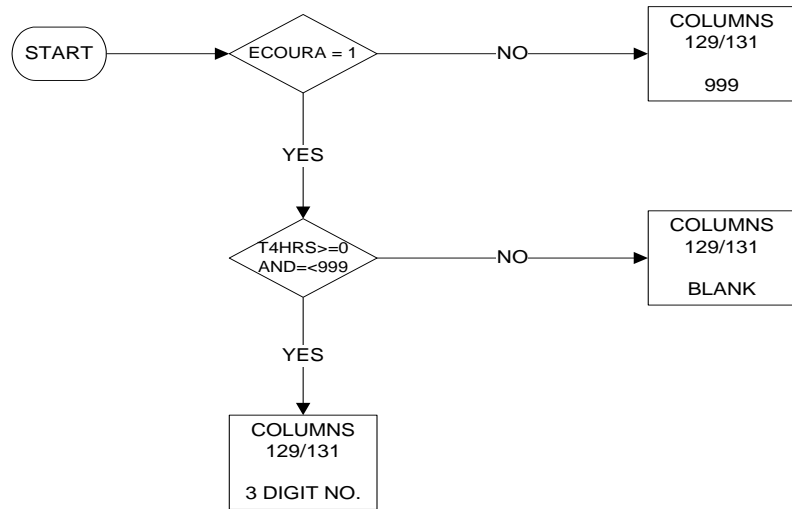

KEY	
3 digits	Number of hours
999	Not applicable (COURATT = 2, 9, blank)
blank	No answer

COURLEN (ECOURL16): Number of hours spent on all taught learning activities within the last four weeks
Columns 129/131

Start date: 2016 Q1

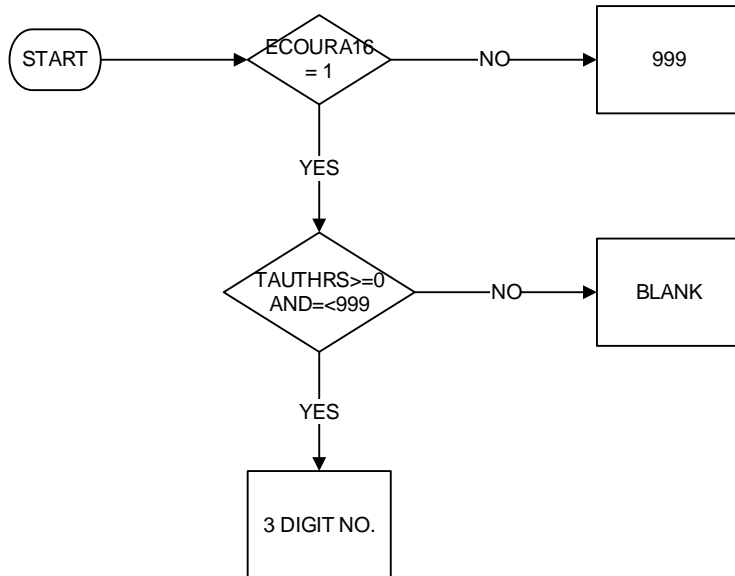

KEY	
3 digits	Number of hours
999	Not applicable (COURATT = 2, 9, blank)
blank	No answer

COURPURP (ECOURP): Purpose of the most recent taught learning activity

Column 132

PAGE 1 OF 1

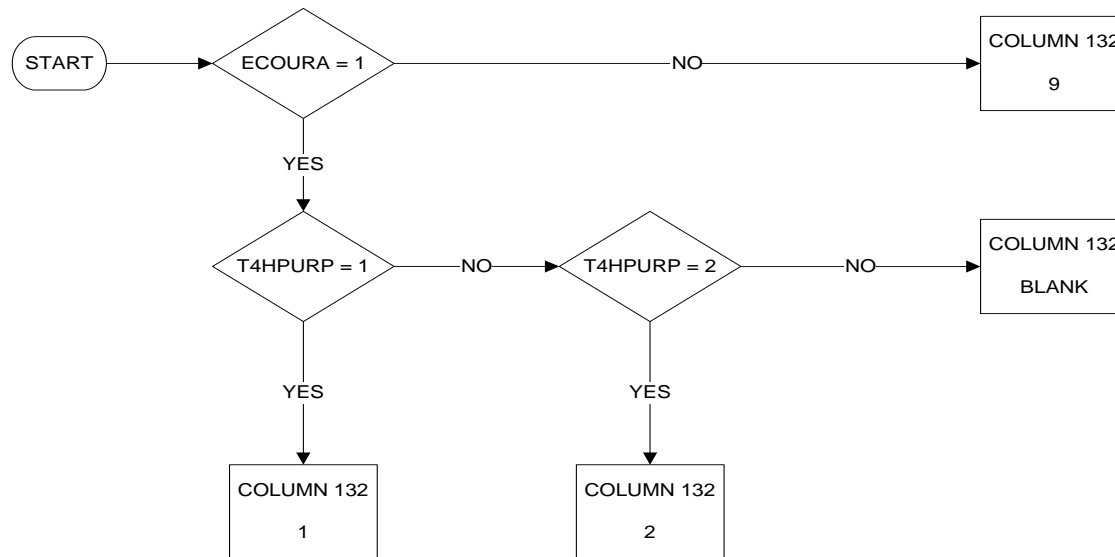

KEY	
1	Mostly job related (professional)
2	Mostly personal/social
9	Not applicable (COURATT = 2,9,blank)
blank	No answer

COURPURP (ECOURP16): Purpose of the most recent taught learning activity
Col. 132

Start date: 2016 Q1

NB - Periodicity revised from all waves to wave 1 only from Jan 2016

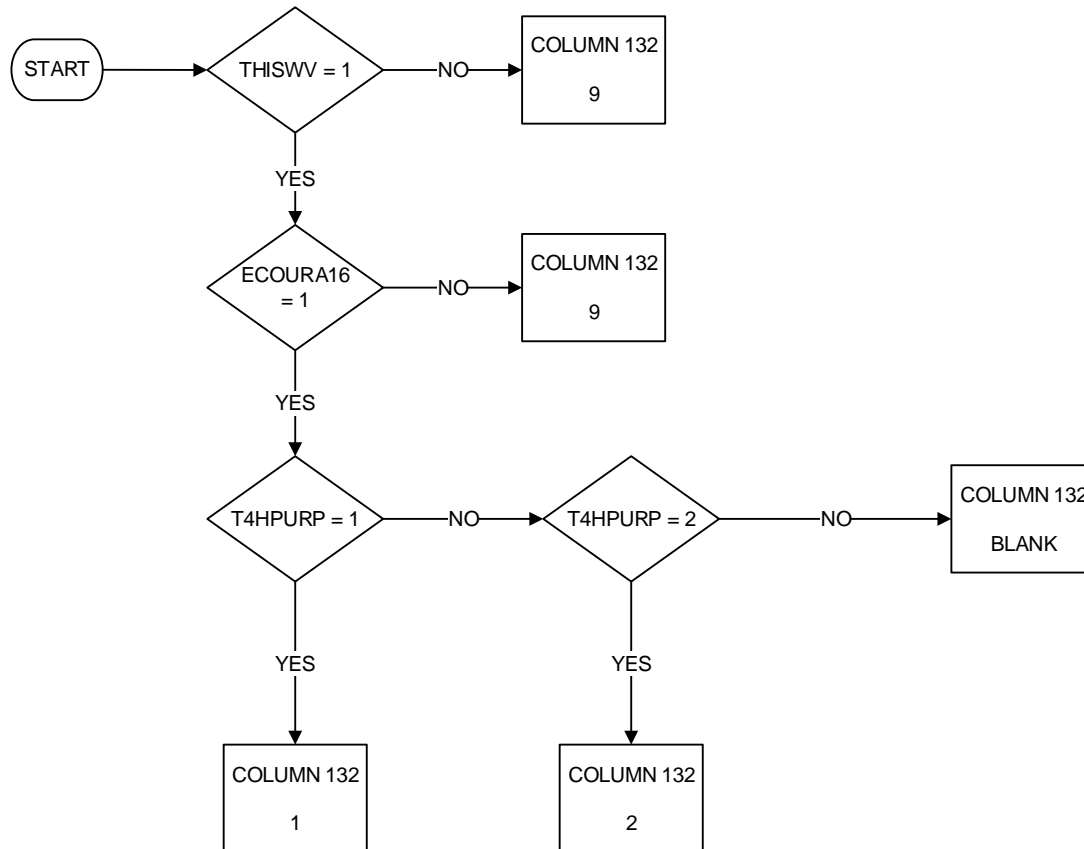

KEY	
1	Mostly job related (professional)
2	Mostly personal/social
9	Not applicable (COURATT = 2,9,blank or THISWW = 2-5)
blank	No answer

COURFILD (ECOURF): Field of the most recent taught learning activity

Column 133/135

PAGE 1 OF 2

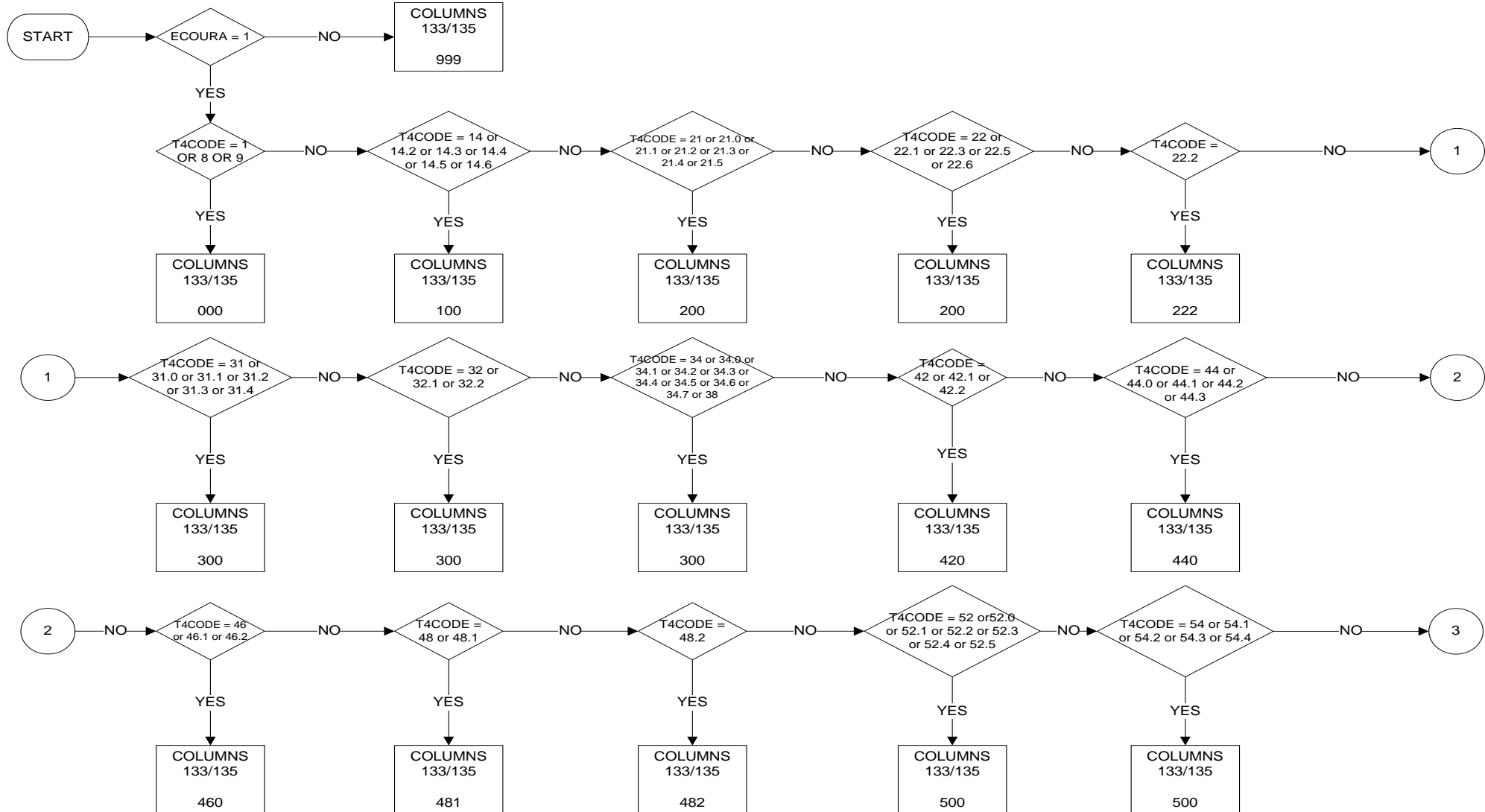

COURFILD (ECOURF): Field of the most recent taught learning activity

Column 133/135

PAGE 2 OF 2

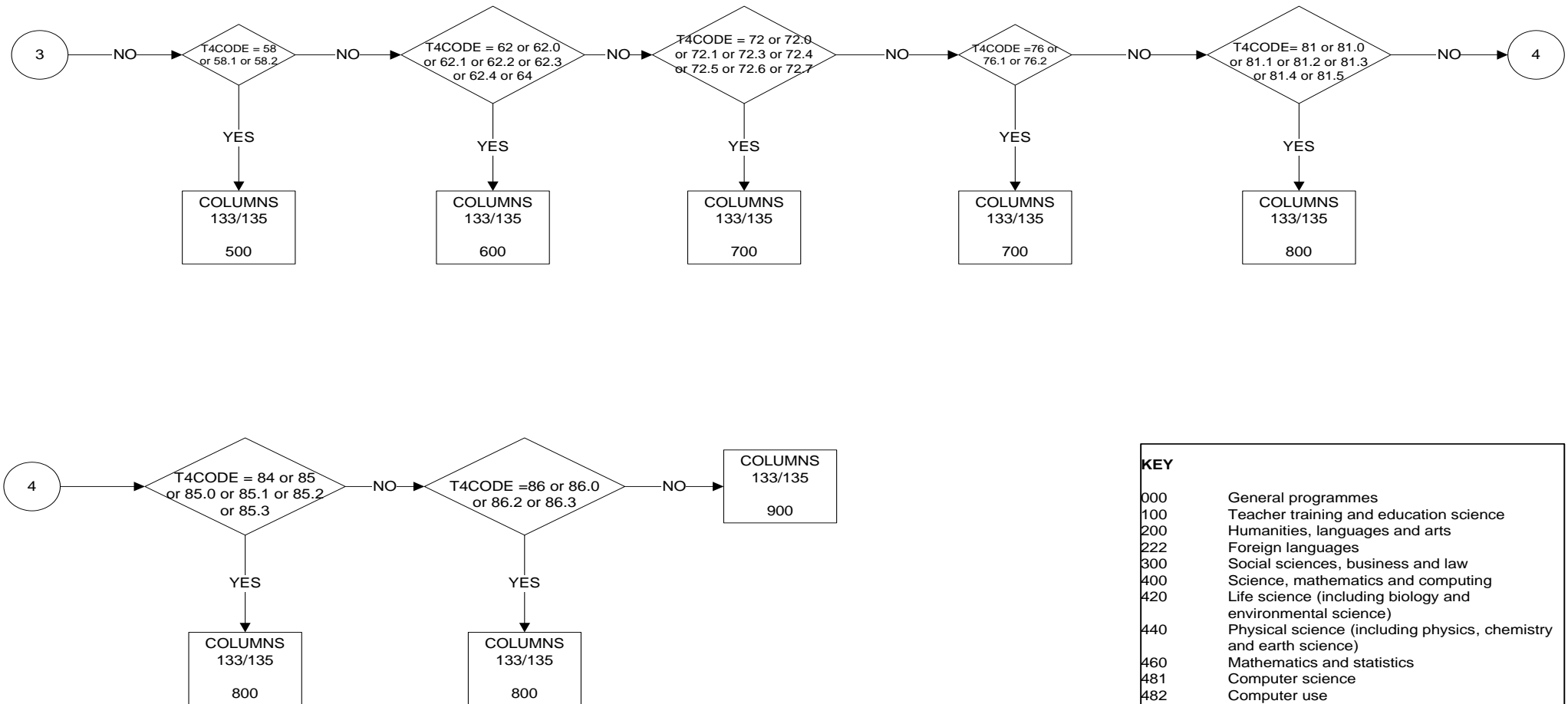

KEY	
000	General programmes
100	Teacher training and education science
200	Humanities, languages and arts
222	Foreign languages
300	Social sciences, business and law
400	Science, mathematics and computing
420	Life science (including biology and environmental science)
440	Physical science (including physics, chemistry and earth science)
460	Mathematics and statistics
481	Computer science
482	Computer use
500	Engineering, manufacturing and construction
600	Agriculture and veterinary
700	Health and welfare
800	Services
900	Unknown
999	Not applicable (COURATT = 2, 9, blank)
blank	No answer

COURFILD (ECOURF16): Field of the most recent taught learning activity
 Cols 133/135

Start date: Jan 2016

NB - Periodicity revised from all waves to wave 1 only from Jan 2016

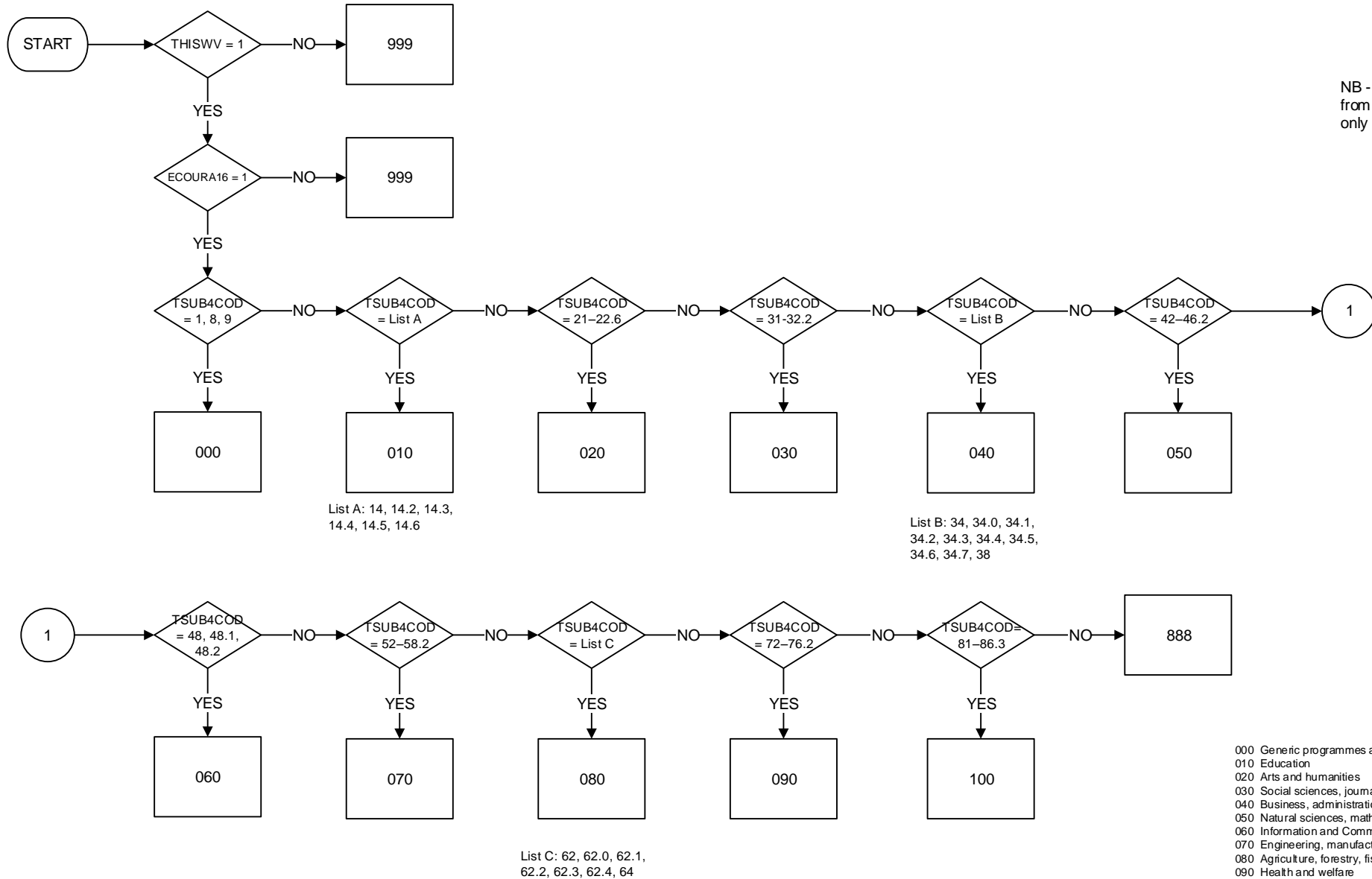

- 000 Generic programmes and qualifications
- 010 Education
- 020 Arts and humanities
- 030 Social sciences, journalism and information
- 040 Business, administration and law
- 050 Natural sciences, mathematics and statistics
- 060 Information and Communication Technologies
- 070 Engineering, manufacturing and construction
- 080 Agriculture, forestry, fisheries and veterinary
- 090 Health and welfare
- 100 Services
- 888 Unknown or unspecified
- 999 Not applicable

COURWORK (ECOURW): Whether recent taught learning activity took place during paid working hours

Column 136

PAGE 1 OF 1

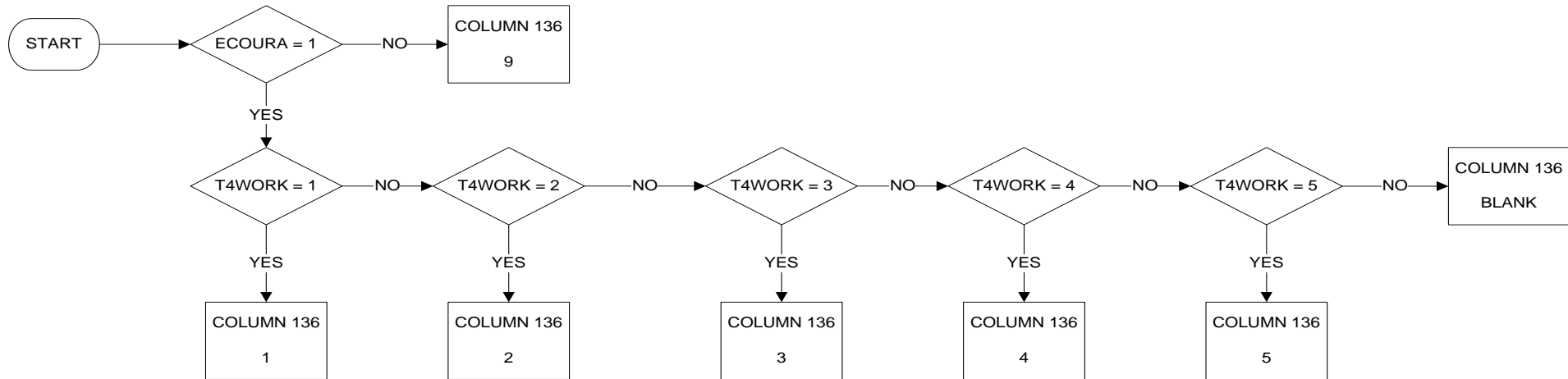

KEY	
1	Only during paid working hours
2	Mostly during paid working hours
3	Mostly outside paid working hours
4	Only outside paid working hours
5	No job at that time
9	Not applicable (COURATT = 2,9,blank)
blank	No answer

COURWORK (ECOURW16): Whether recent taught learning activity took place during paid working hours
Col. 136

Start date: 2016 Q1

NB - Periodicity revised from all waves to wave 1 only from Jan 2016

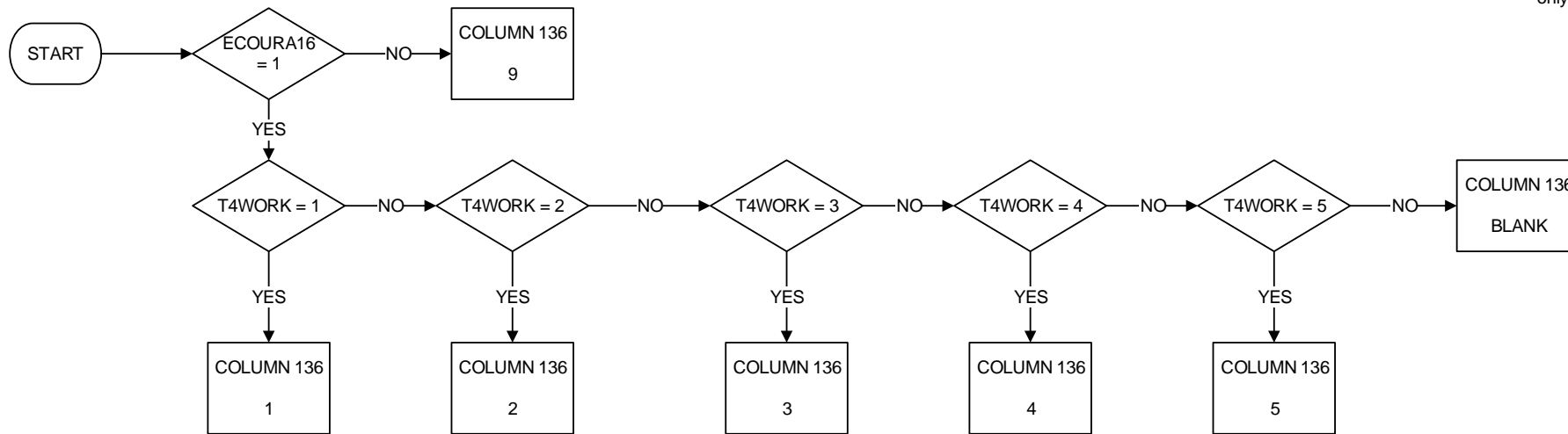

KEY	
1	Only during paid working hours
2	Mostly during paid working hours
3	Mostly outside paid working hours
4	Only outside paid working hours
5	No job at that time
9	Not applicable (COURATT = 2,9,blank or THISWV = 2-5)
blank	No answer

HATLEVEL (EHATLEV): Highest level of education or training successfully completed

Columns 137/138

PAGE 1 OF 1

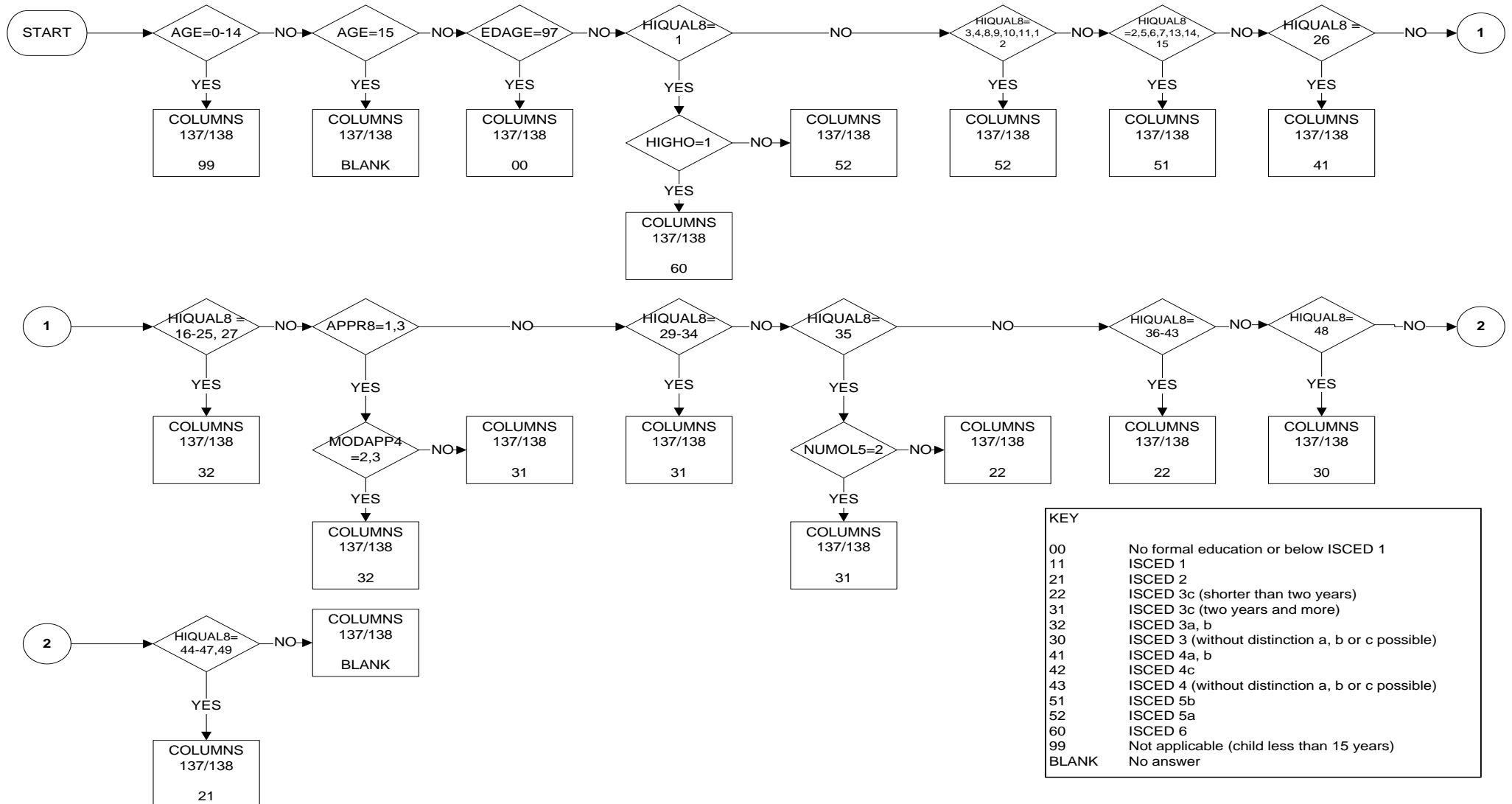

KEY	
00	No formal education or below ISCED 1
11	ISCED 1
21	ISCED 2
22	ISCED 3c (shorter than two years)
31	ISCED 3c (two years and more)
32	ISCED 3a, b
30	ISCED 3 (without distinction a, b or c possible)
41	ISCED 4a, b
42	ISCED 4c
43	ISCED 4 (without distinction a, b or c possible)
51	ISCED 5b
52	ISCED 5a
60	ISCED 6
99	Not applicable (child less than 15 years)
BLANK	No answer

HATFIELD (EHATFLD): Field of highest level of education or training successfully completed

Columns 139/141

PAGE 1 OF 2

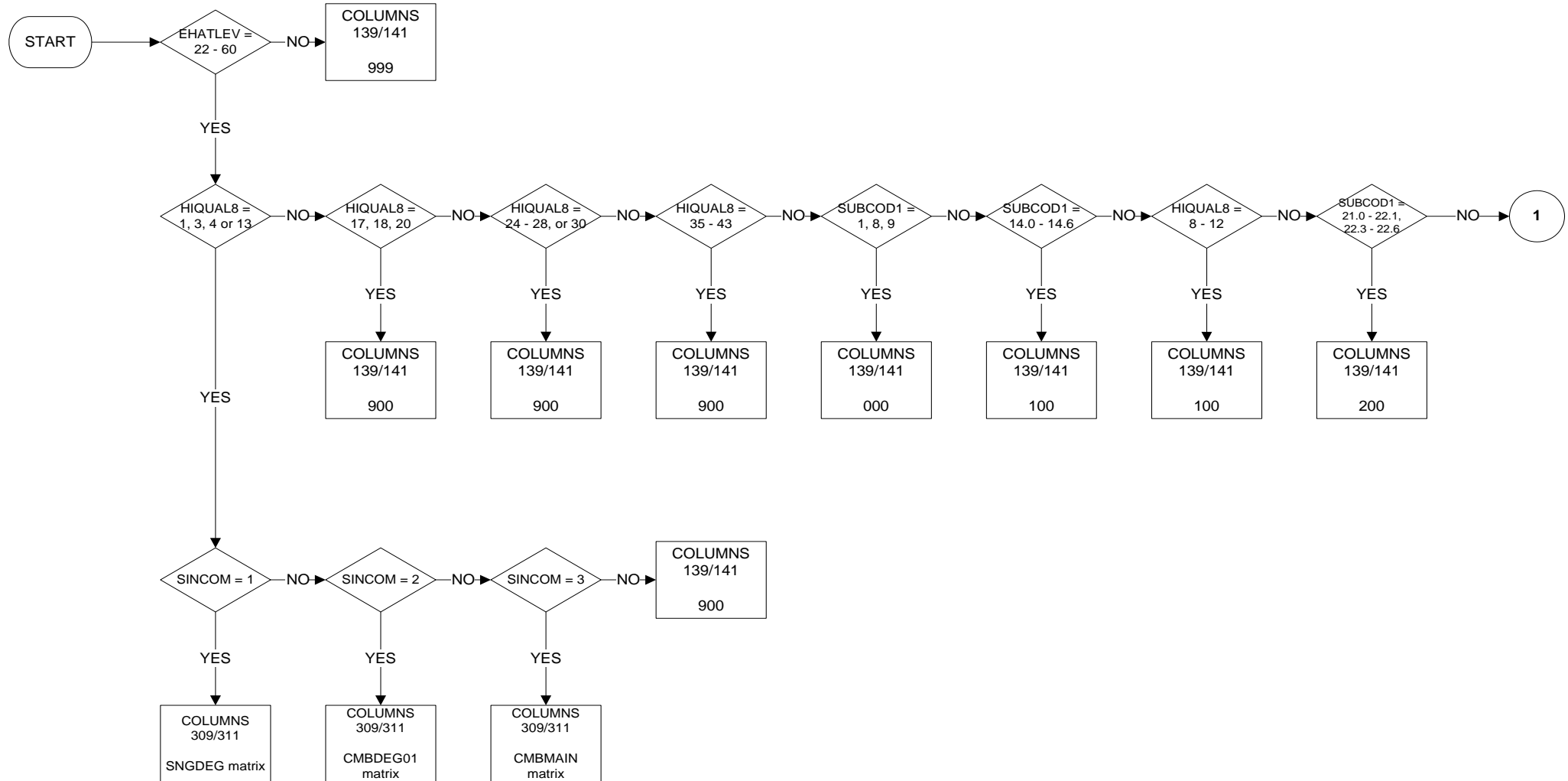

HATFIELD (EHATFLD): Field of highest level of education or training successfully completed

Columns 139/141

PAGE 2 OF 2

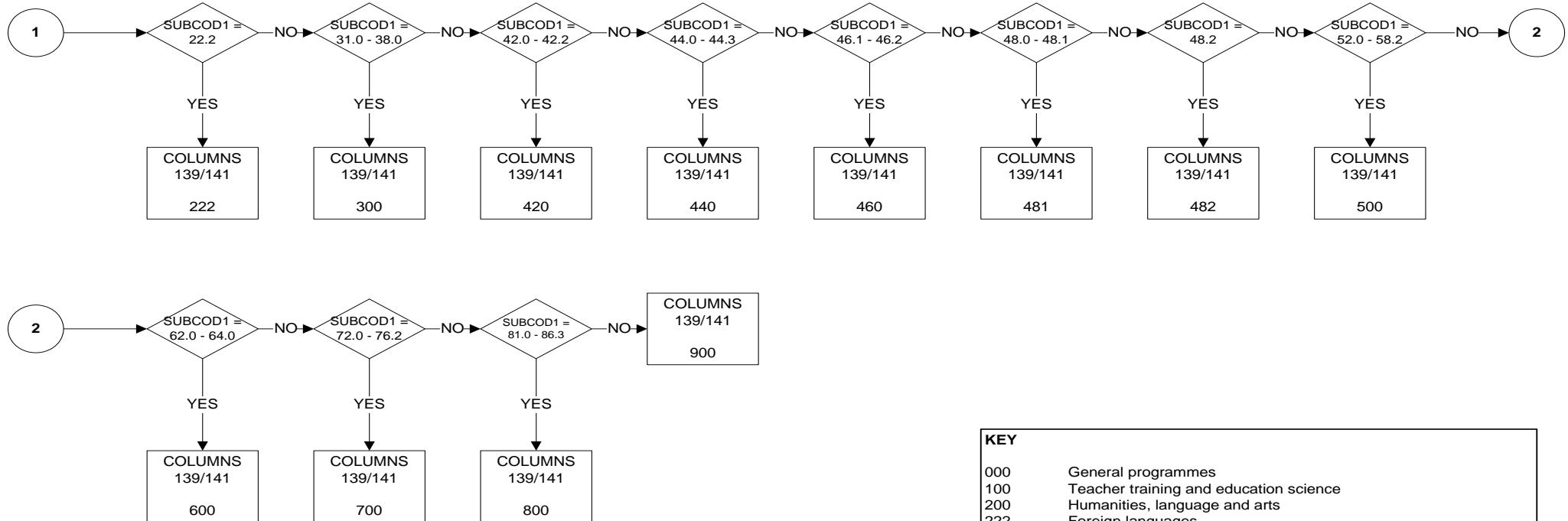

KEY

000	General programmes
100	Teacher training and education science
200	Humanities, language and arts
222	Foreign languages
300	Social science, business and law
400	Science, mathematics and computing
420	Life science (including biology and environmental science)
440	Physical science (including physics, chemistry and earth science)
460	Mathematics and statistics
481	Computer science
482	Computer use
500	Engineering, manufacturing and construction
600	Agriculture and veterinary
700	Health and welfare
800	Services
900	unknown
999	Not applicable (HATLEVEL = 00, 11, 21, 99, BLANK)
BLANK	No answer

Notes

SUBCOD1 values output as string not numeric, see attached coding frame.

HATYEAR (EHATYR): Year when highest level of education or training successfully completed

Columns 142/145

PAGE 1 OF 1

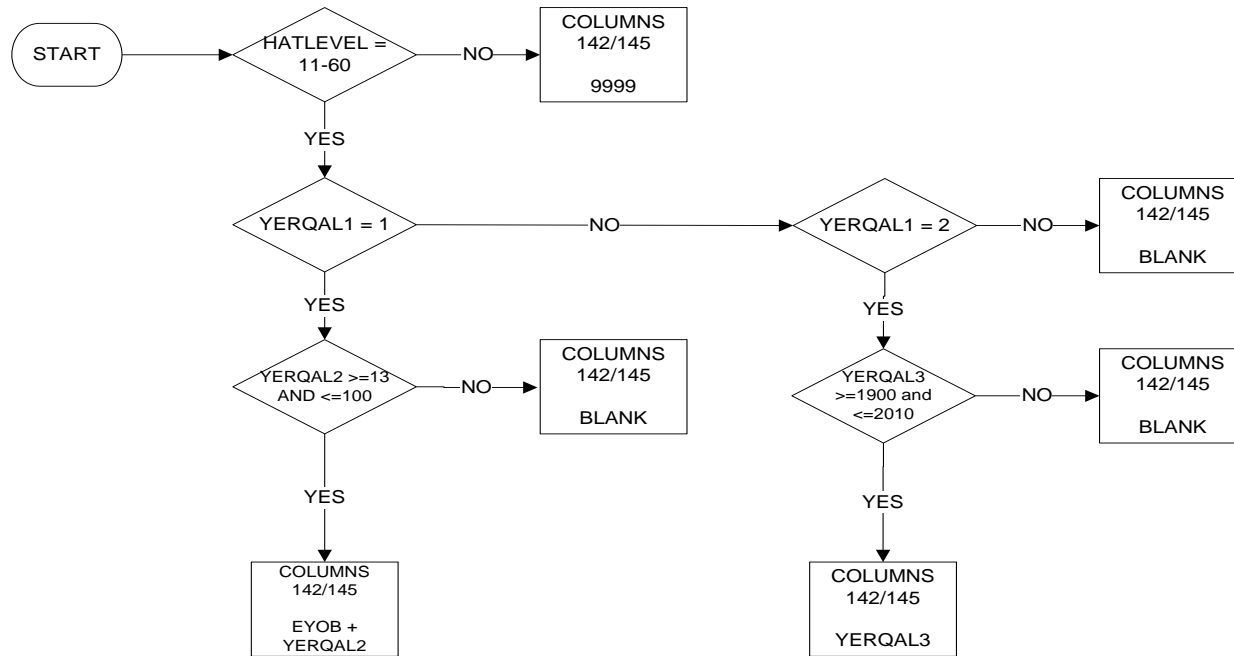

KEY

The 4 digits of year when highest level of education or training was successfully completed are entered

9999 Not applicable (HATLEVEL = 11-60)
BLANK No answer

WSTAT1Y (ESITONE): Situation with regard to activity one year ago

Column 146

PAGE 1 OF 1

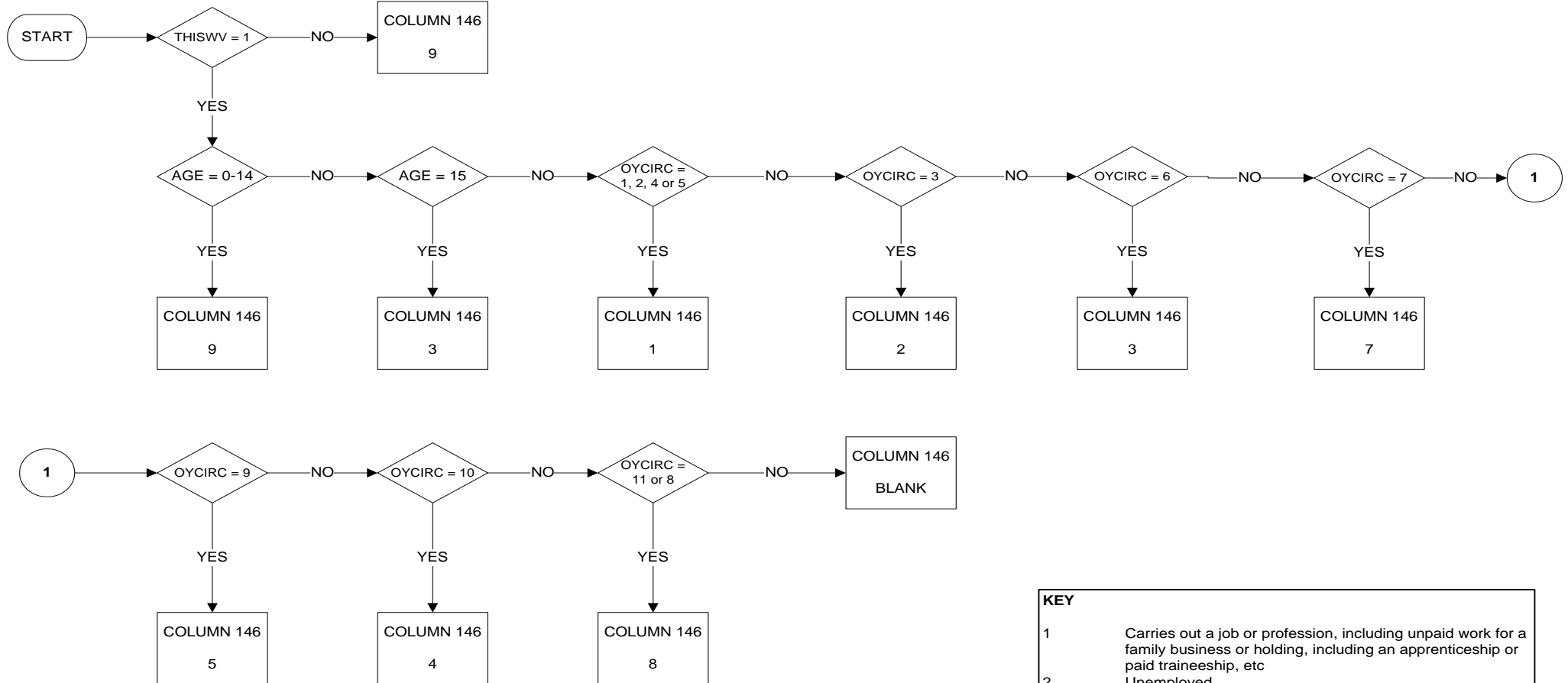

KEY	
1	Carries out a job or profession, including unpaid work for a family business or holding, including an apprenticeship or paid traineeship, etc
2	Unemployed
3	Pupil, student, further training, unpaid work experience
4	In retirement or early retirement or has given up business
5	Permanently disabled
6	In compulsory military service
7	Fulfilling domestic tasks
8	Other inactive person
9	Not applicable (child less than 15 years)
BLANK	No answer

STAPRO1Y (ESTATOR): Professional status one year before survey

Column 147

PAGE 1 OF 1

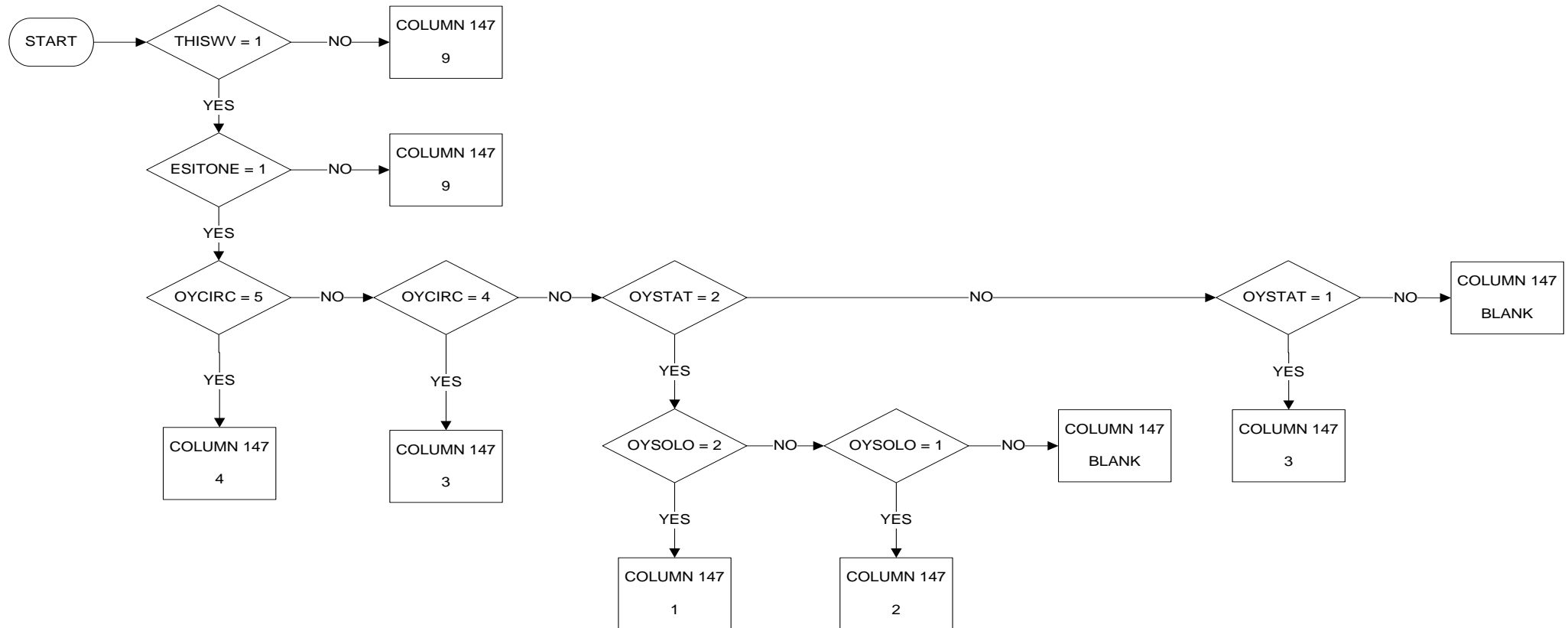

KEY	
1	Self-employed with employees
2	Self-employed without employees
3	Employee
4	Family-worker
9	Not applicable (WSTAT1Y ? 1)
BLANK	No answer

NACE1Y2D (ENACEO8): Economics activity of local unit in which person was working one year before survey

Column 148/149

PAGE 1 OF 1

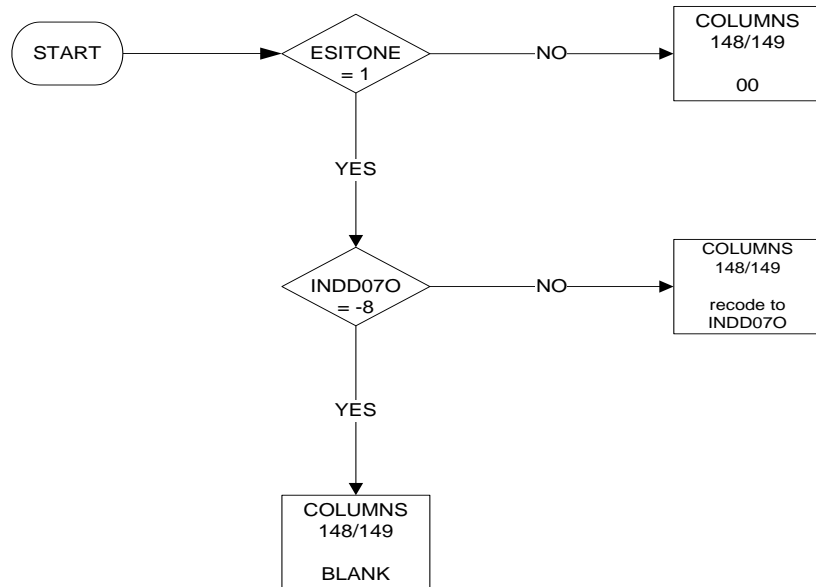

KEY	
	Nace Rev. 2
00	Not applicable (WSTAT1Y ? 1)
Blank	No answer

COUNTR1Y (ECTYO): Country of residence one year before survey

Columns 150/151

PAGE 1 OF 15

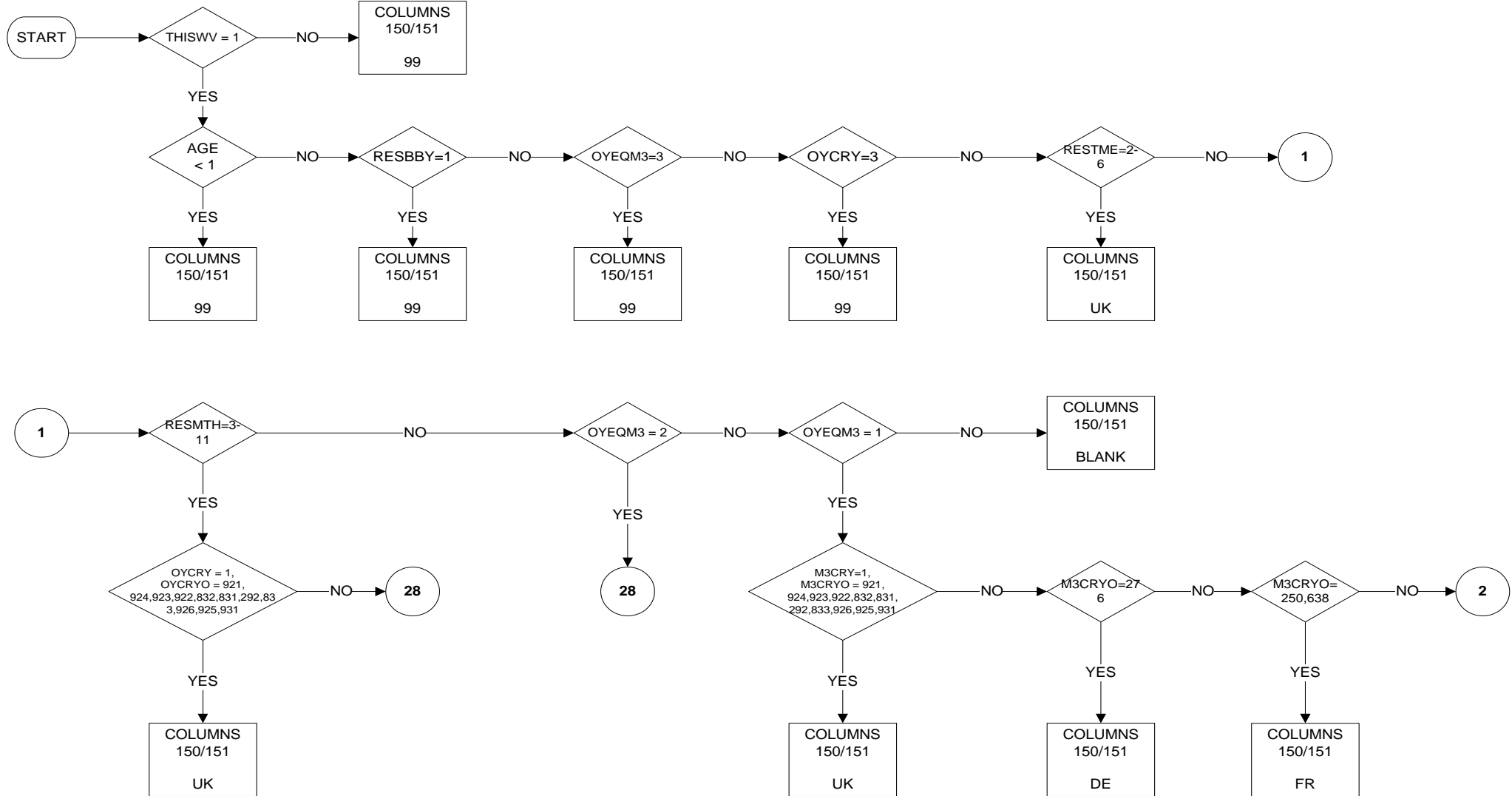

COUNTR1Y (ECTYO): Country of residence one year before survey

Columns 150/151

PAGE 2 OF 15

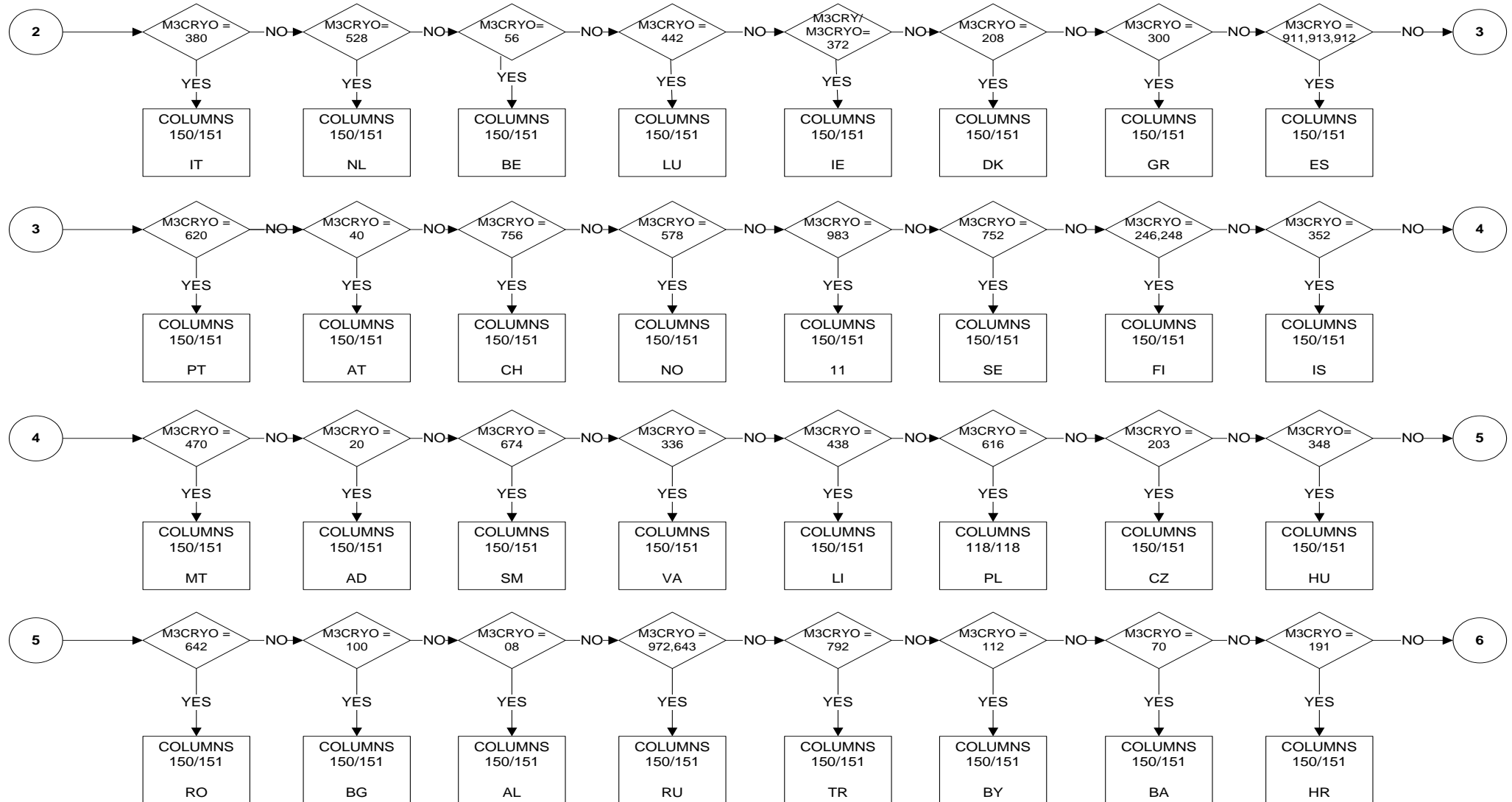

COUNTR1Y (ECTYO): Country of residence one year before survey

Columns 150/151

PAGE 3 OF 15

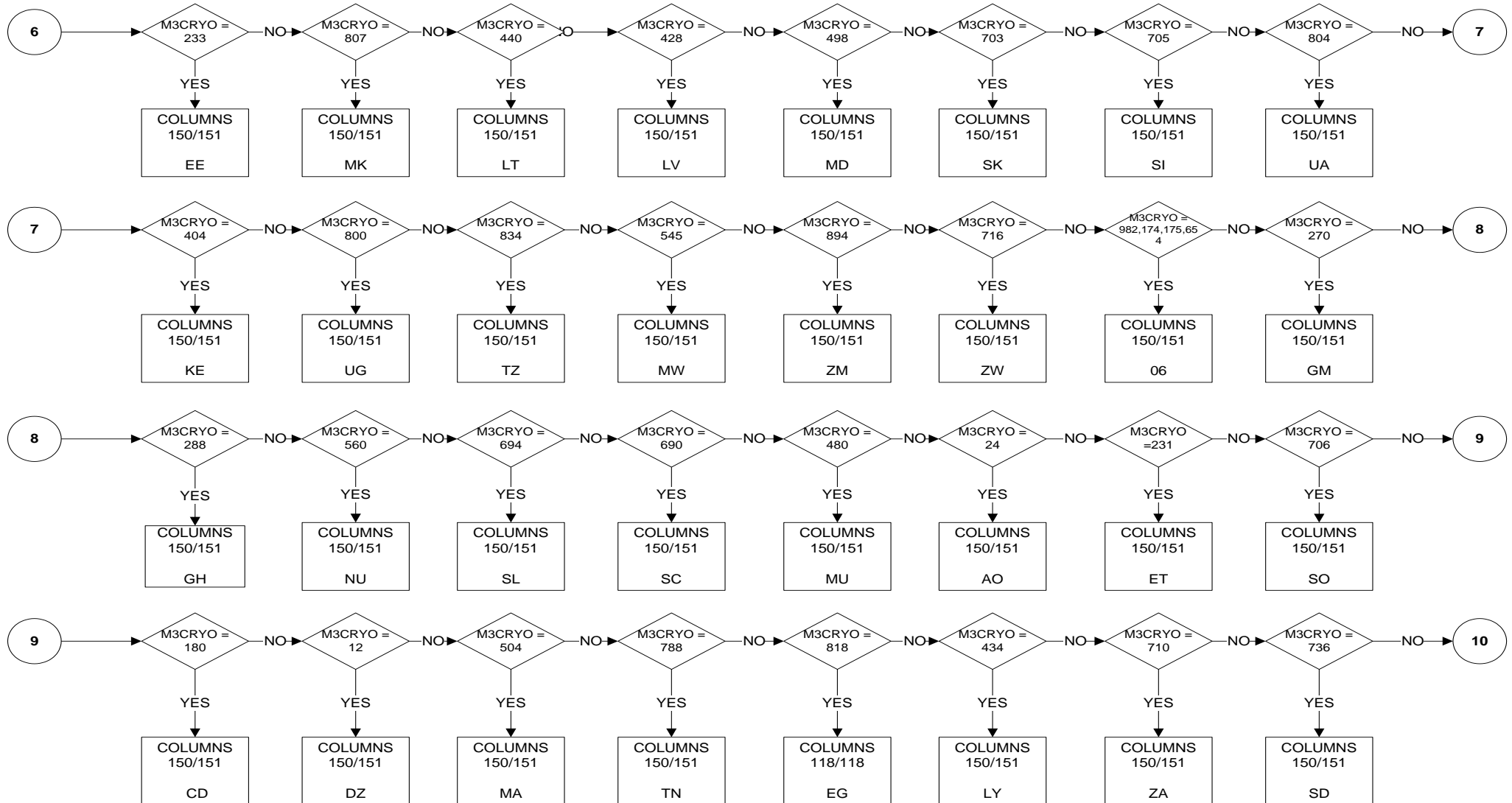

COUNTR1Y (ECTYO): Country of residence one year before survey

Columns 150/151

PAGE 4 OF 15

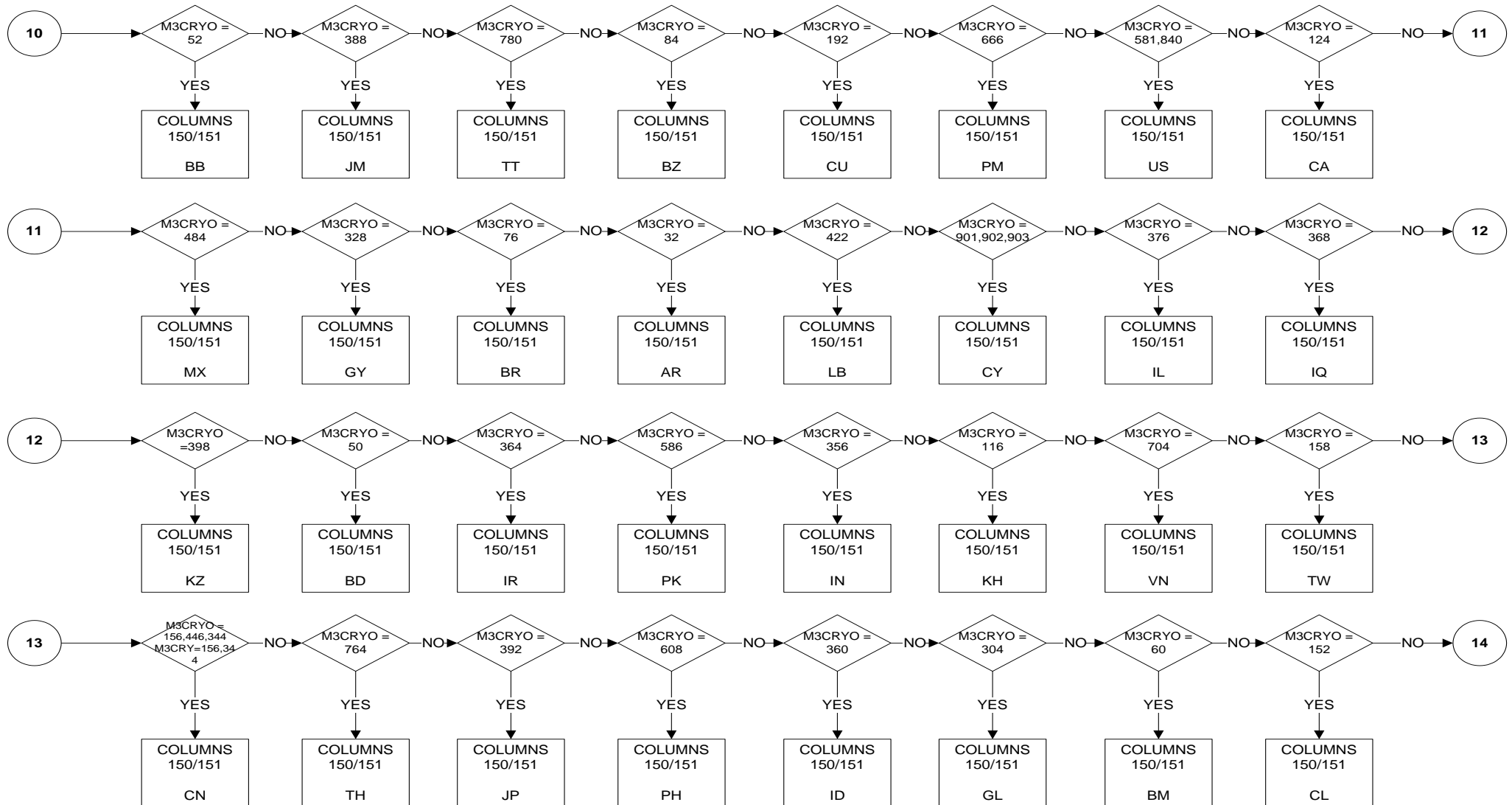

COUNTR1Y (ECTYO): Country of residence one year before survey

Columns 150/151

PAGE 5 OF 15

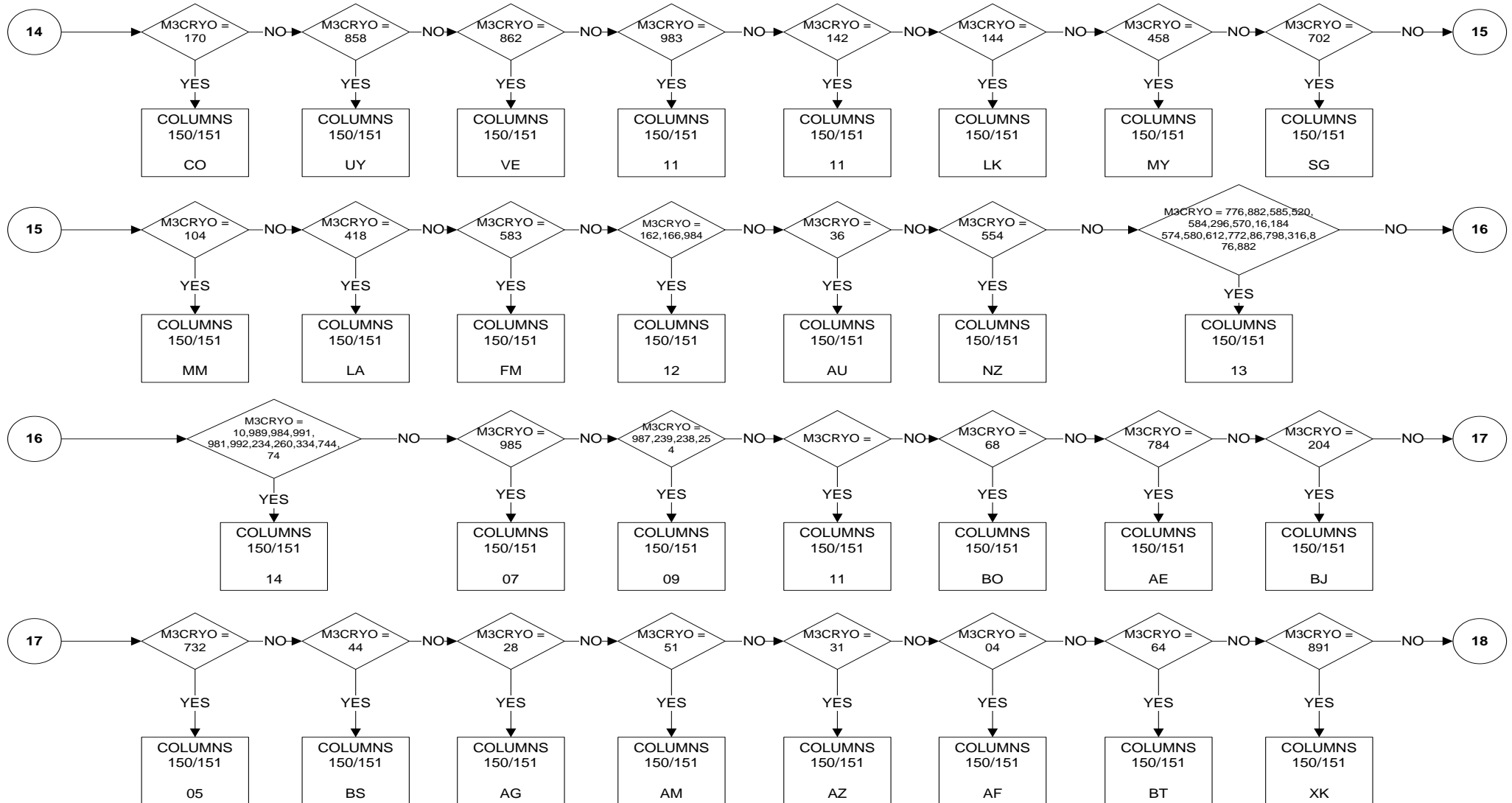

COUNTR1Y (ECTYO): Country of residence one year before survey

Columns 150/151

PAGE 6 OF 15

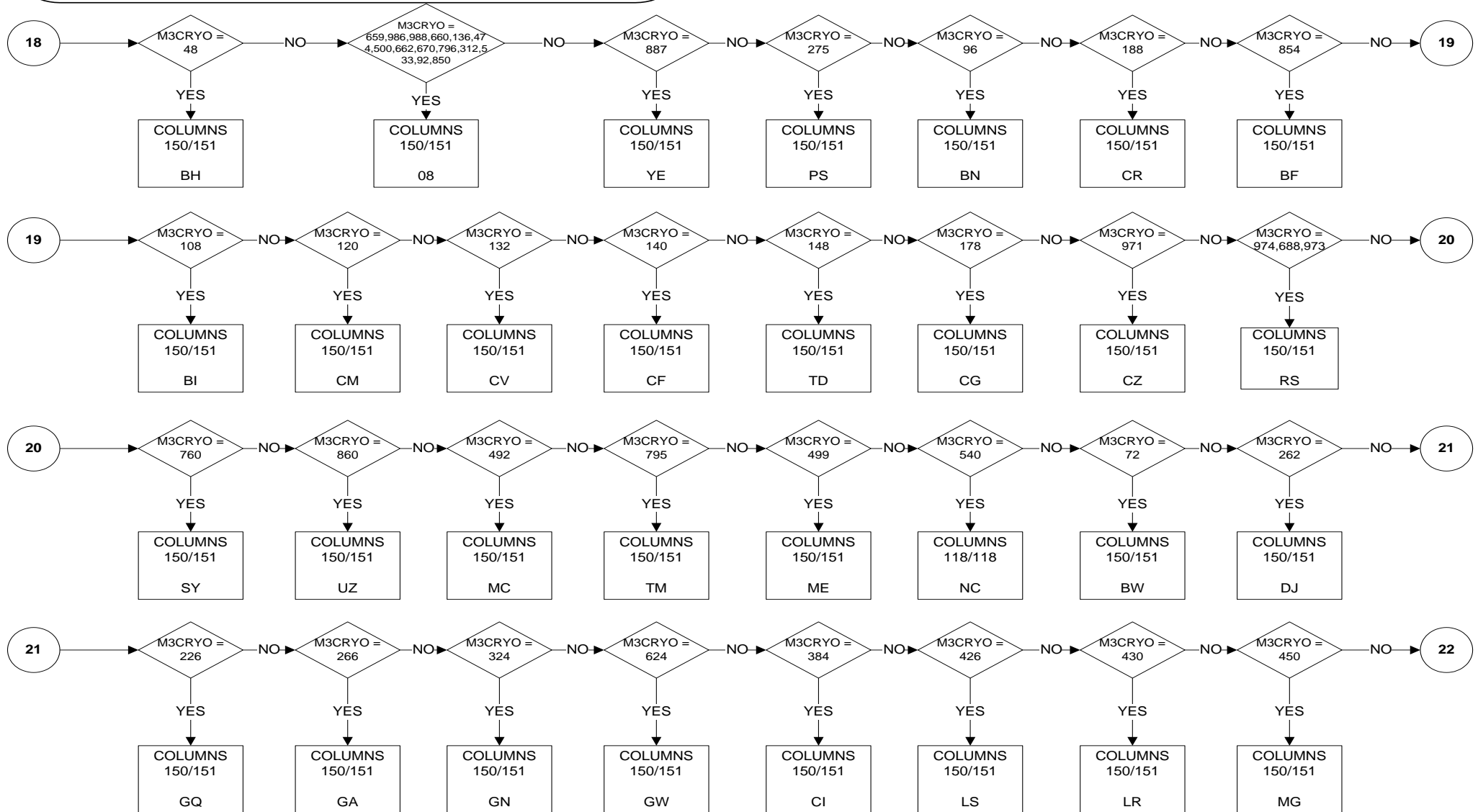

COUNTR1Y (ECTYO): Country of residence one year before survey

Columns 150/151

PAGE 7 OF 15

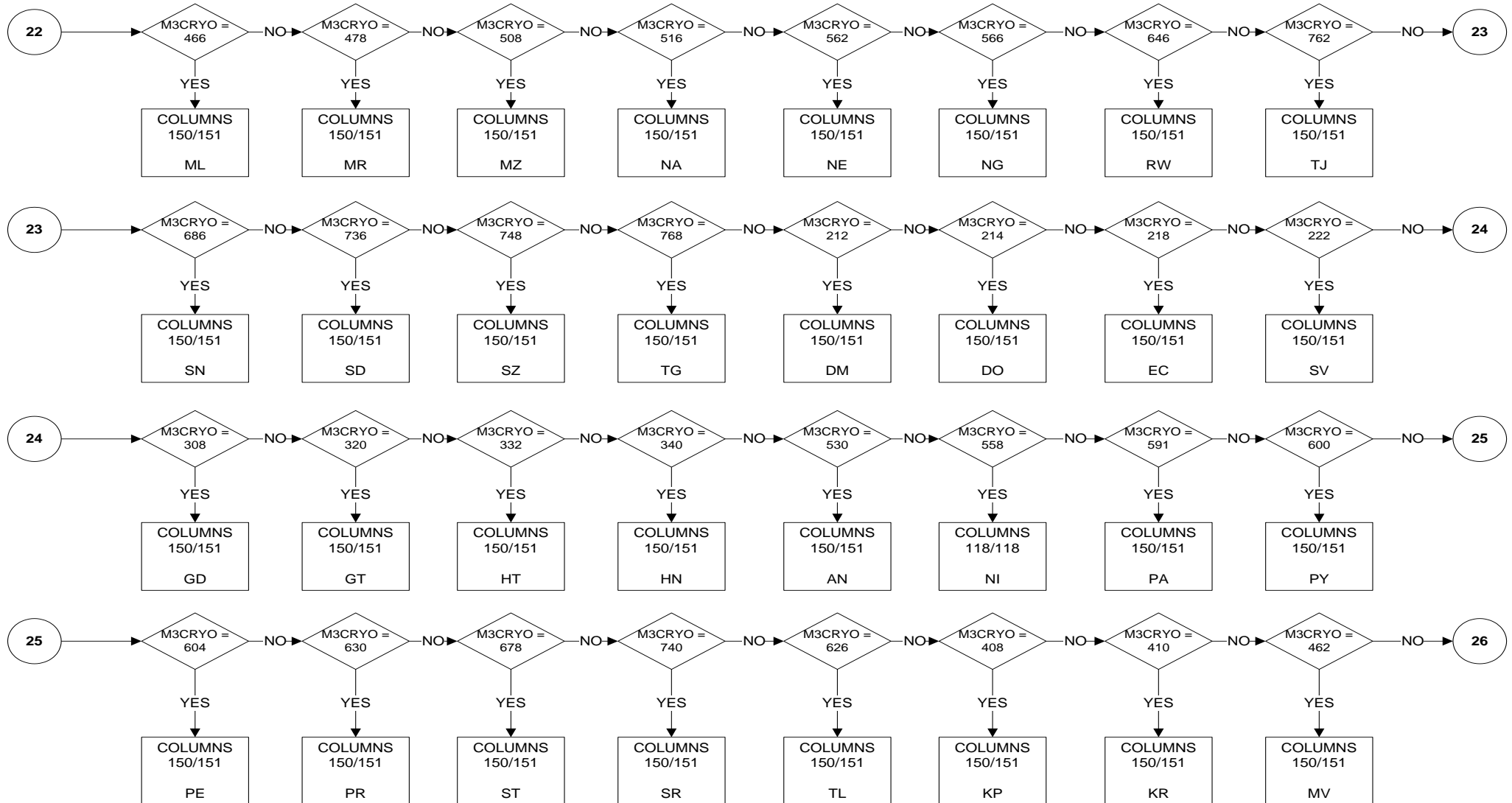

COUNTR1Y (ECTYO): Country of residence one year before survey

Columns 150/151

PAGE 8 OF 15

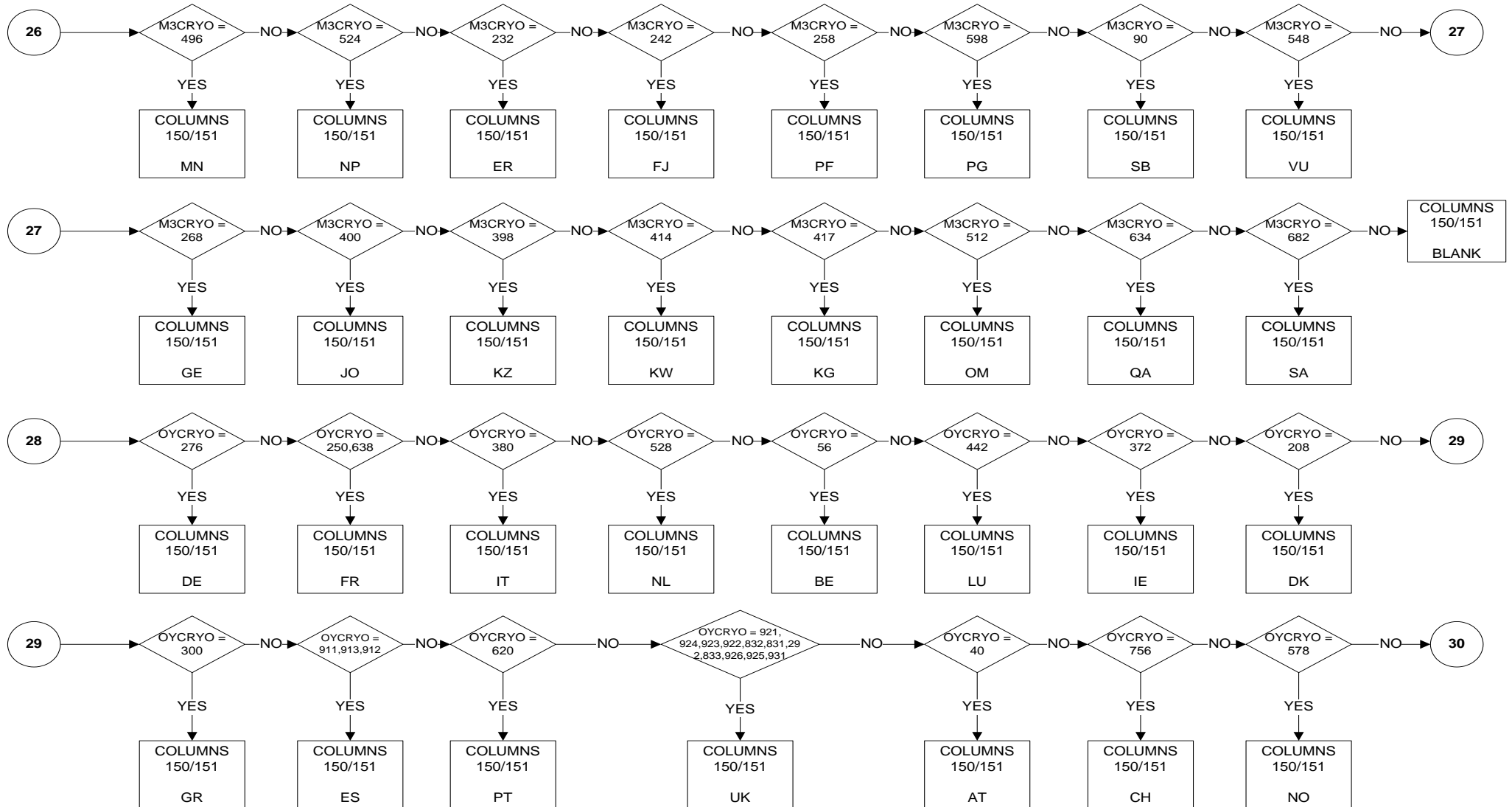

COUNTR1Y (ECTYO): Country of residence one year before survey

Columns 150/151

PAGE 9 OF 15

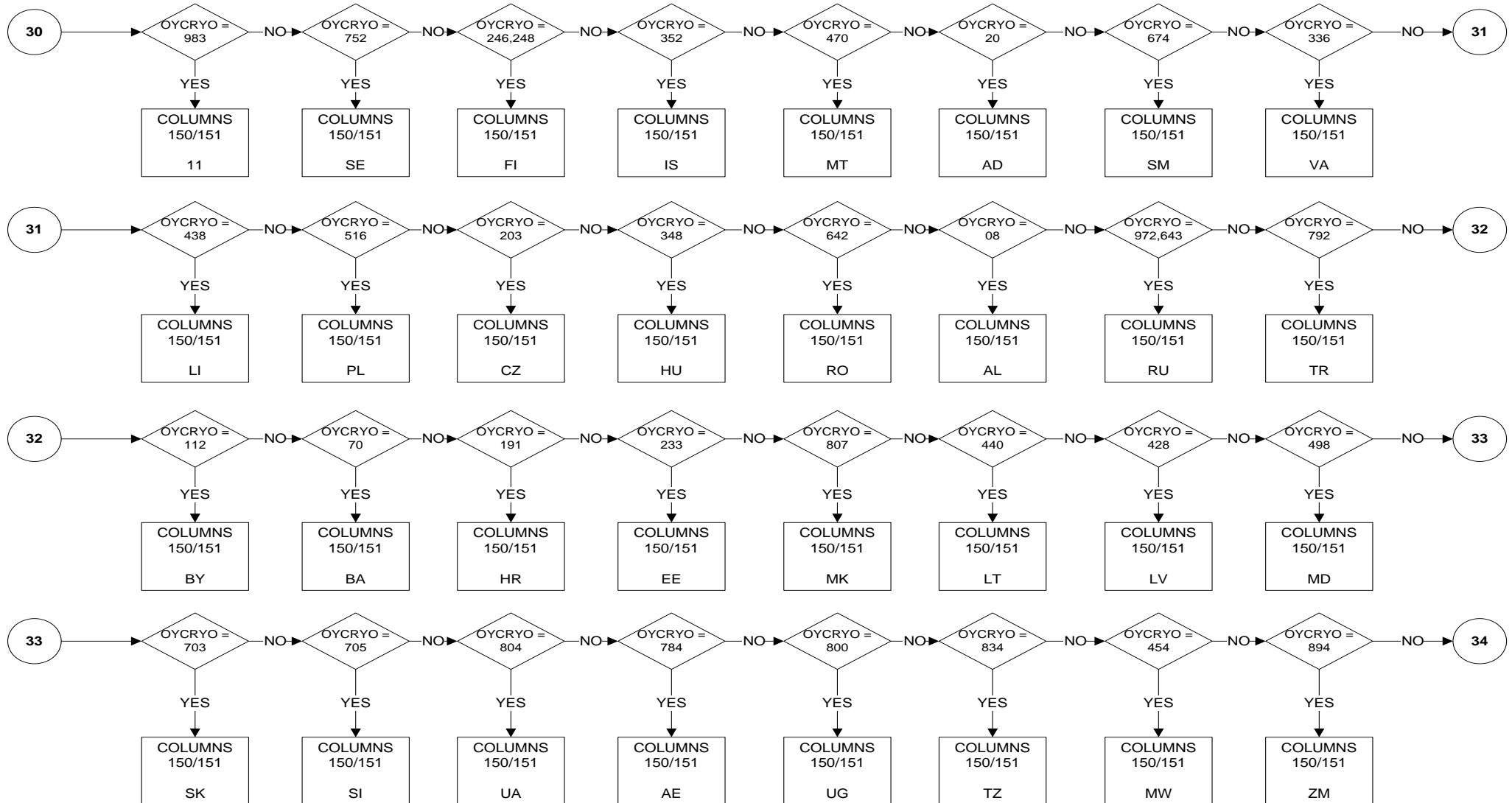

COUNTR1Y (ECTYO): Country of residence one year before survey

Columns 150/151

PAGE 10 OF 15

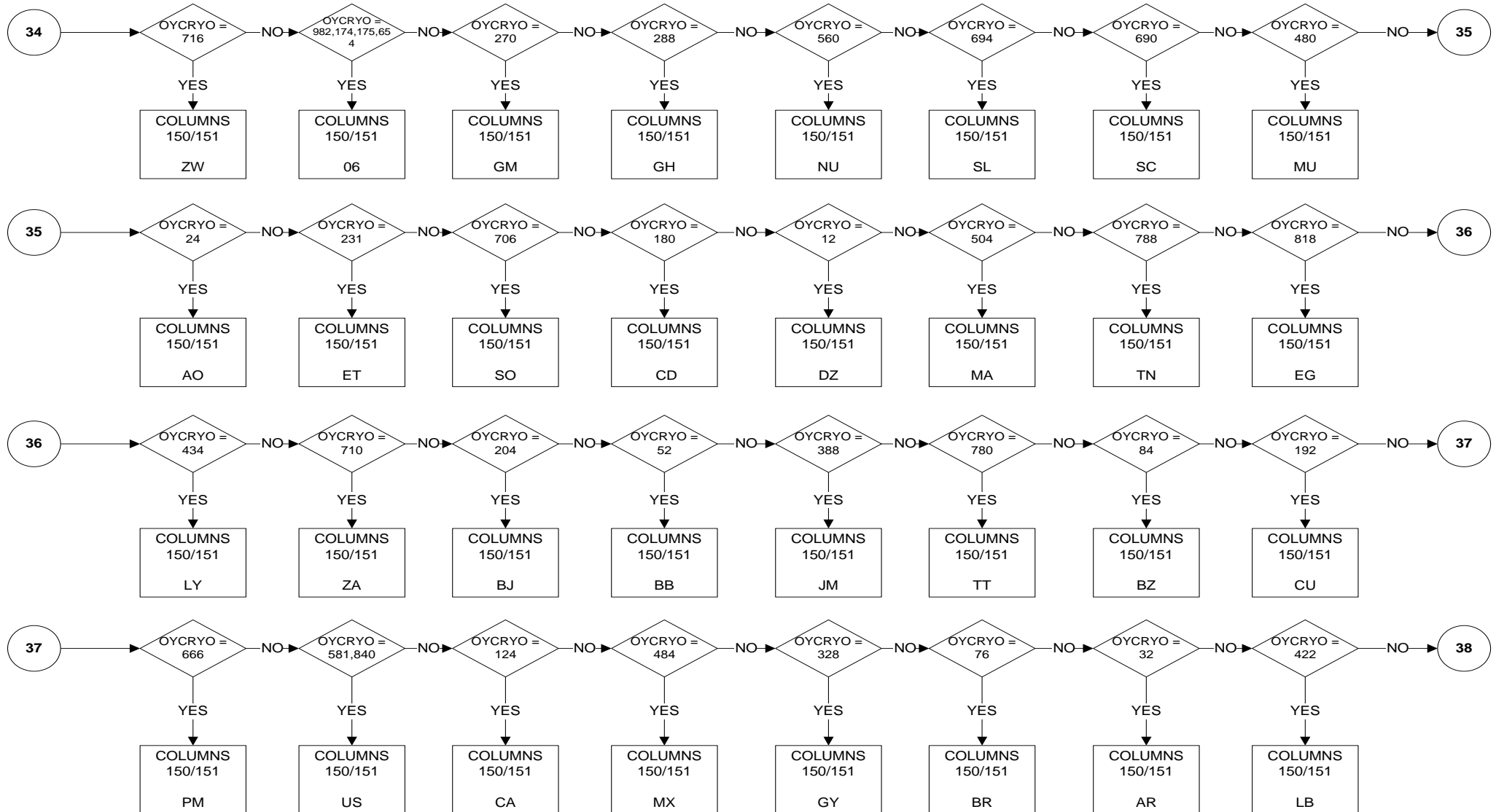

COUNTR1Y (ECTYO): Country of residence one year before survey

Columns 150/151

PAGE 11 OF 15

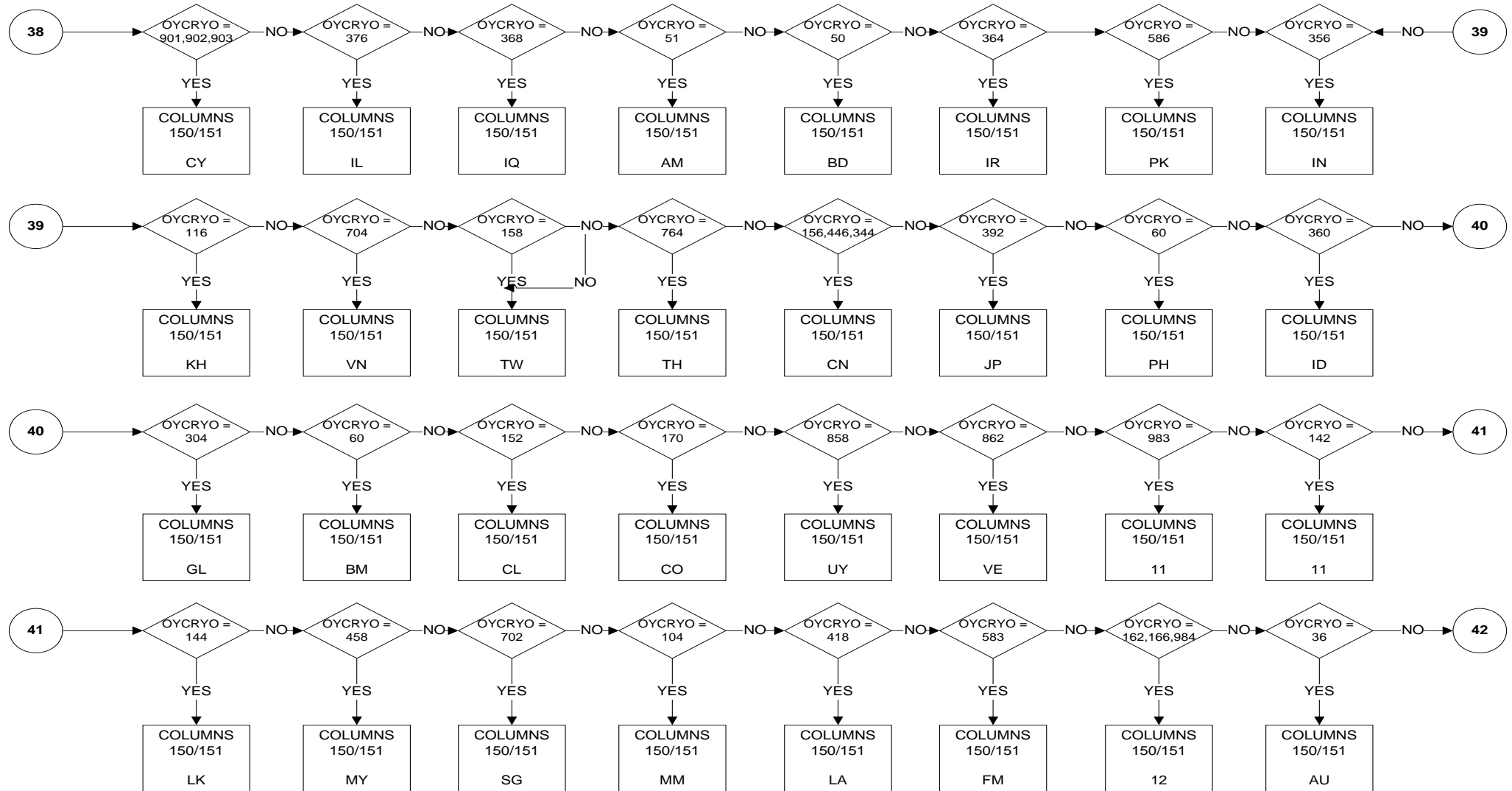

COUNTR1Y (ECTYO): Country of residence one year before survey

Columns 150/151

PAGE 12 OF 15

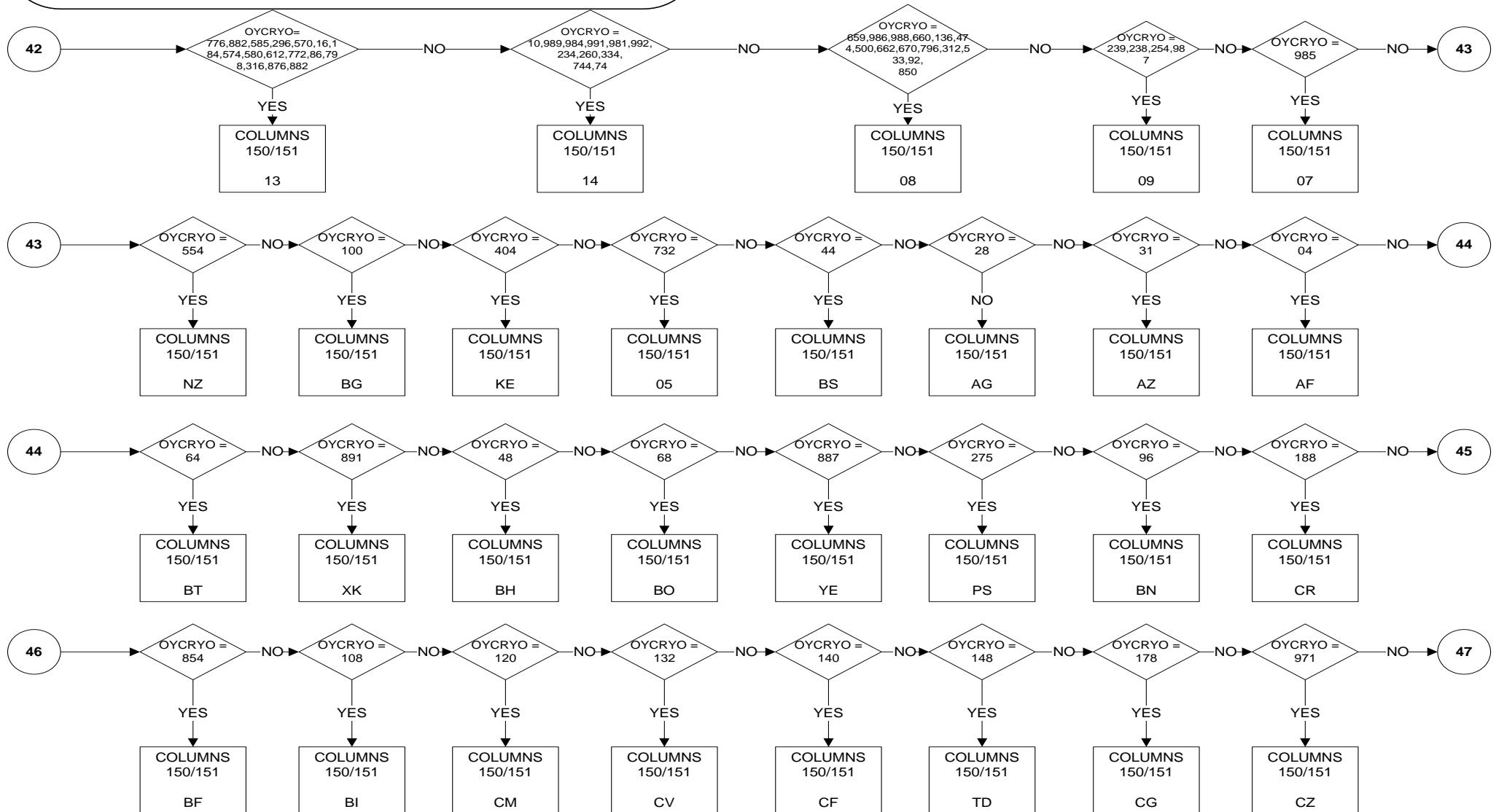

COUNTR1Y (ECTYO): Country of residence one year before survey

Columns 150/151

PAGE 13 OF 15

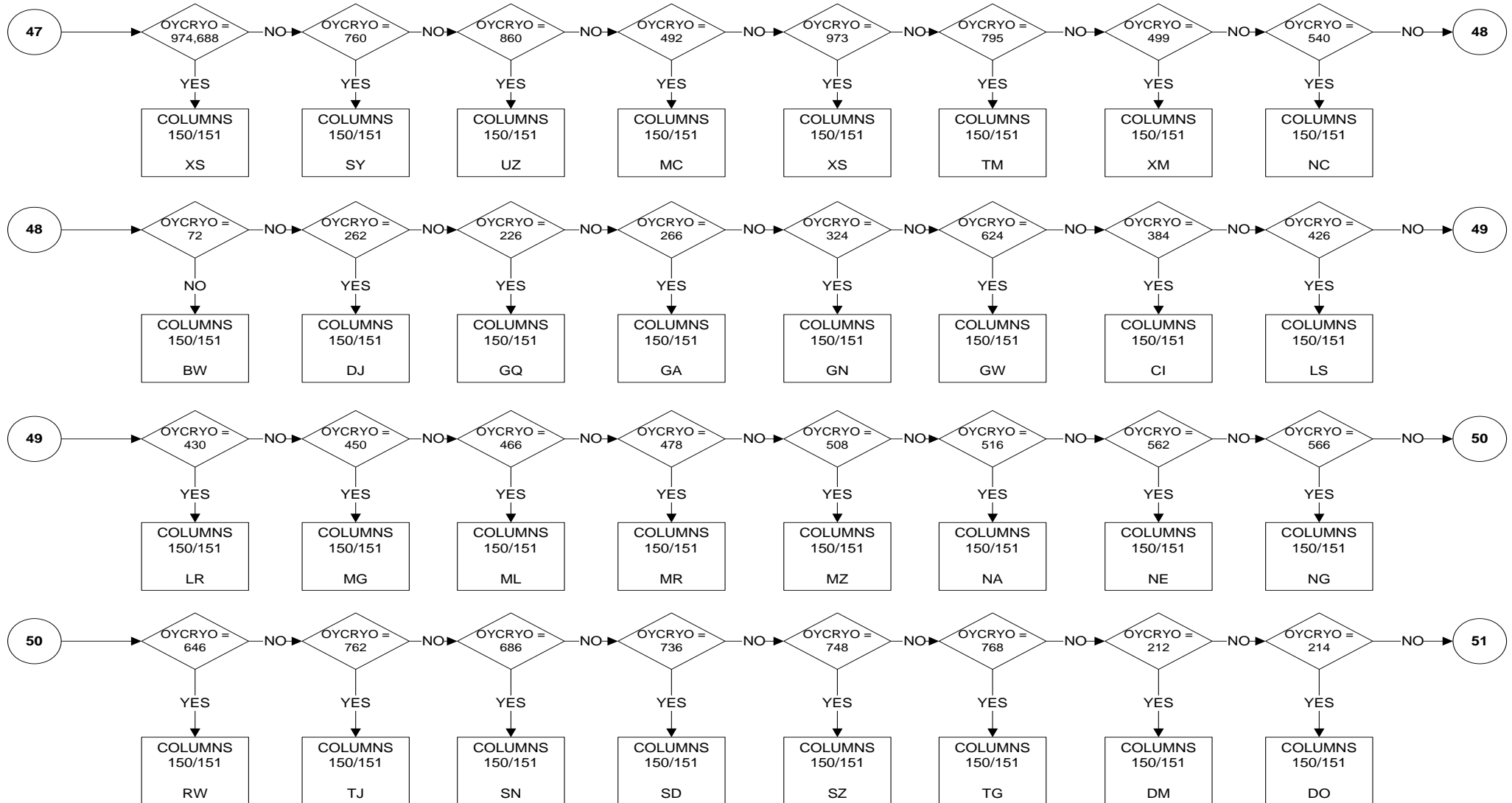

COUNTR1Y (ECTYO): Country of residence one year before survey

Columns 150/151

PAGE 14 OF 15

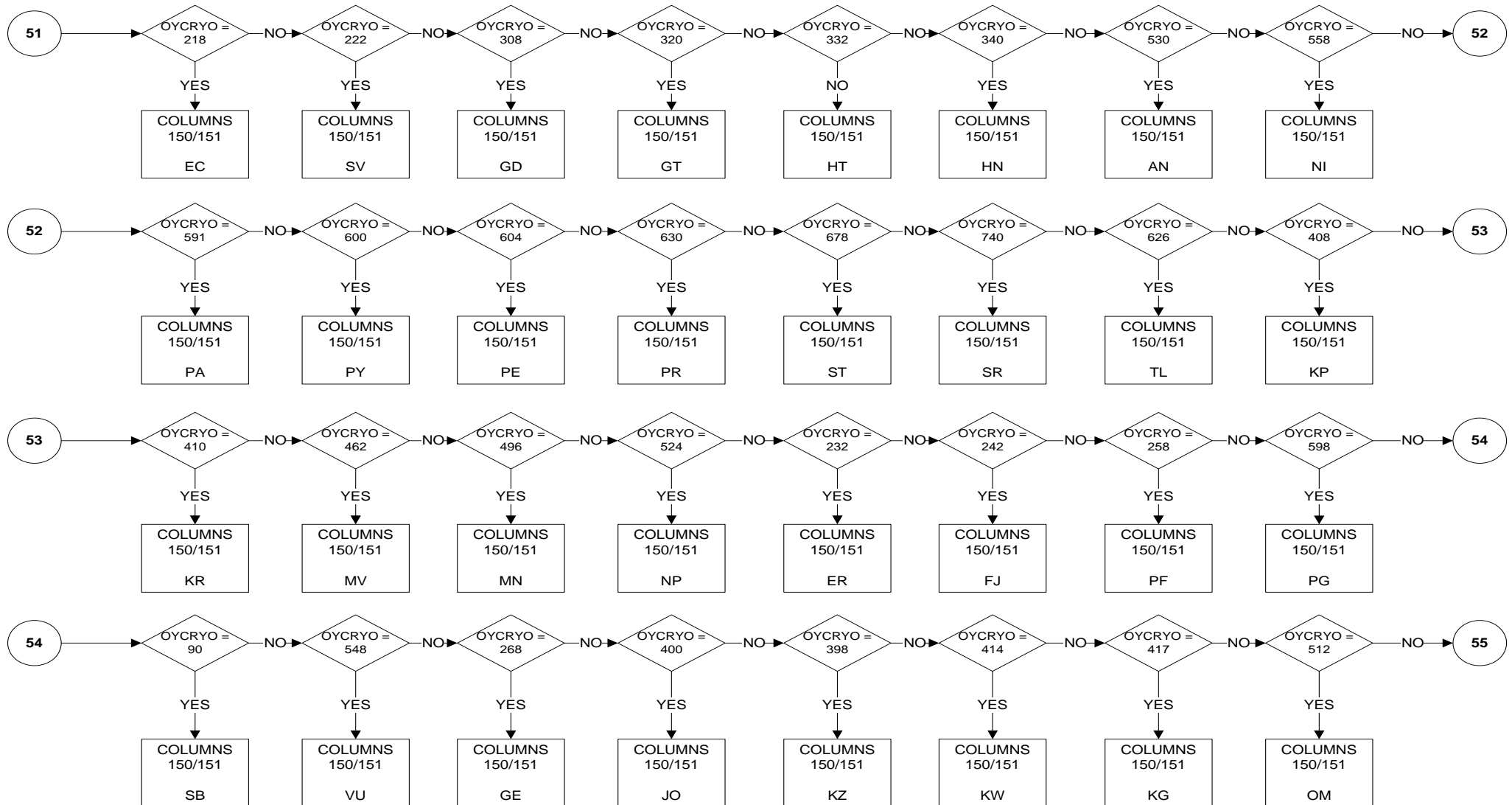

COUNTR1Y (ECTYO): Country of residence one year before survey

Columns 150/151

PAGE 15 OF 15

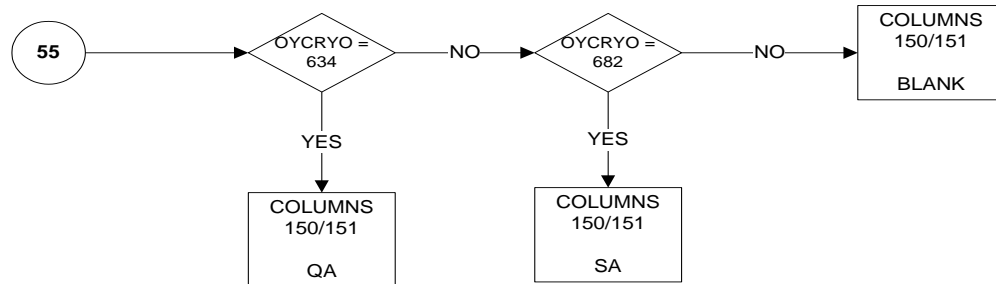

Key

99	Not Applicable (child less than one year old)
Blank	No Answer

REGION1Y (EREG00): Region of residence one year before survey

Column 152/153

PAGE 1 OF 1

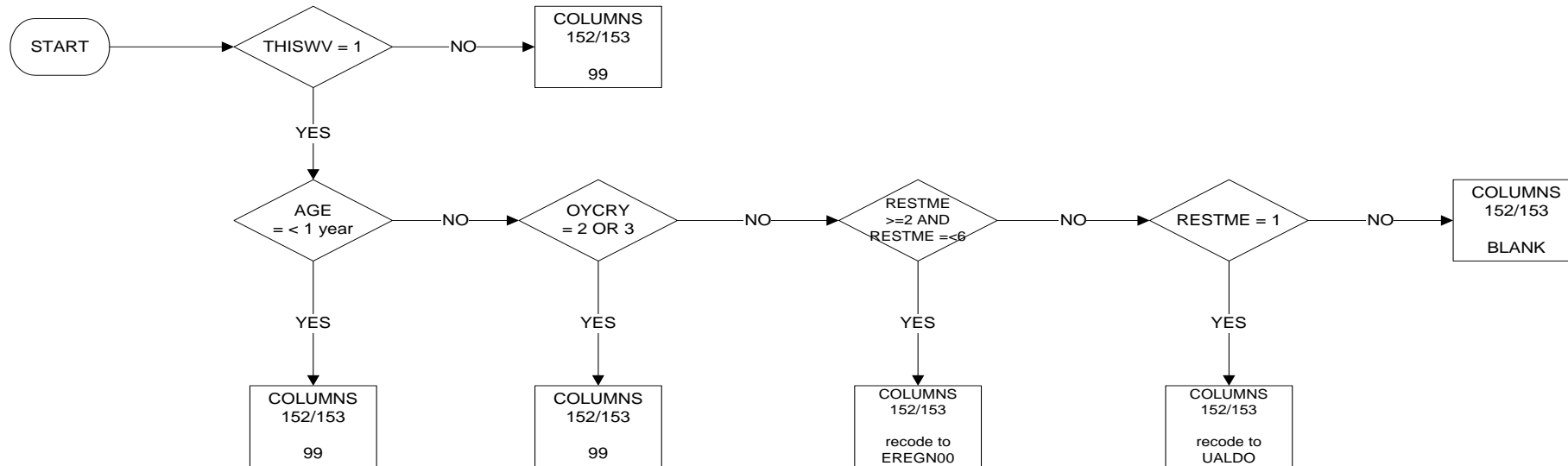

KEY

99 Not applicable (person who has changed country of residence or child less than one year old)
BLANK No answer

ENETMND: Monthly net (take home) pay from main job

Columns 154/155

PAGE 1 OF 15

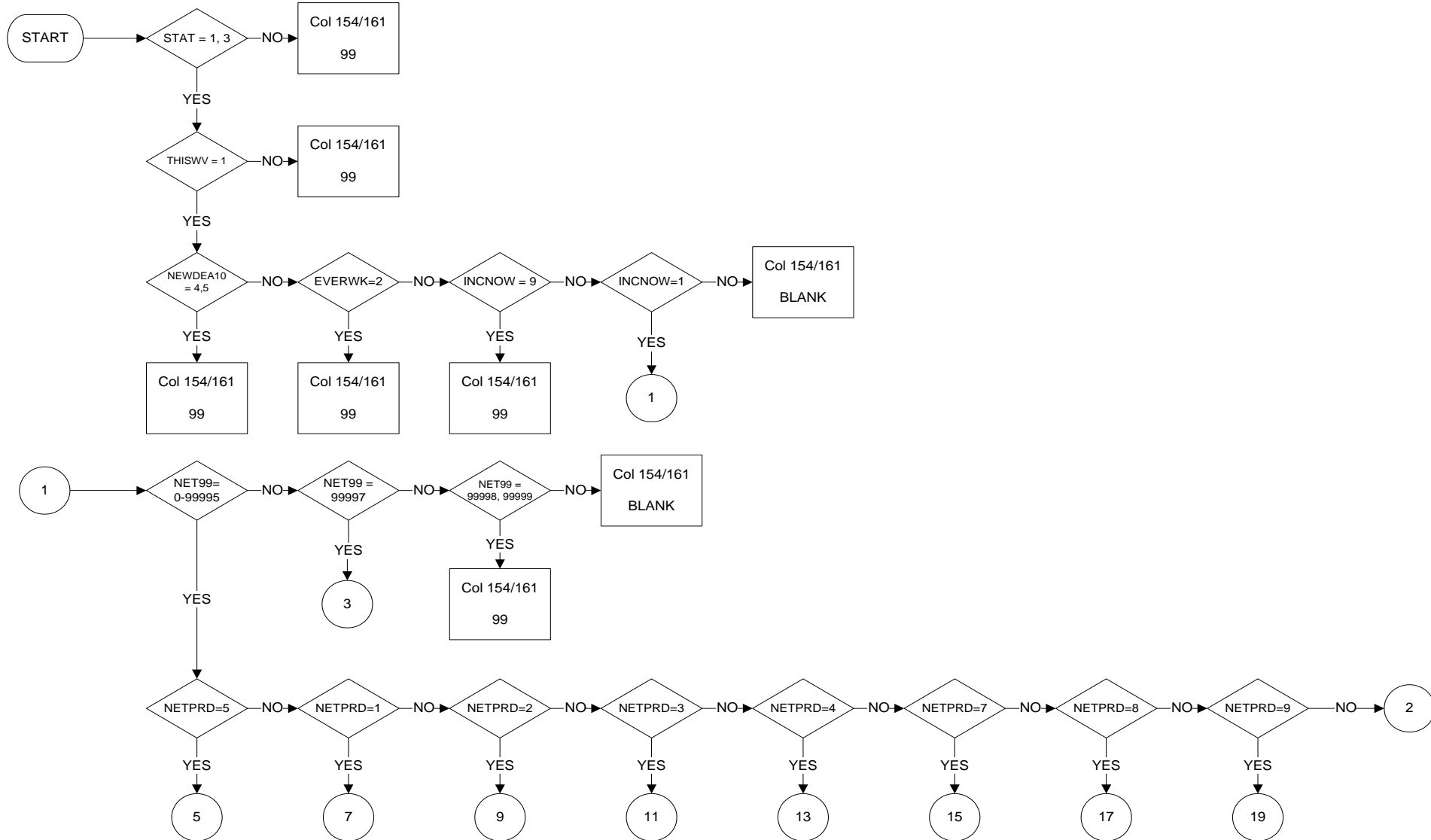

ENTMND: Monthly net (take home) pay from main job

Columns 154/155

PAGE 2 OF 15

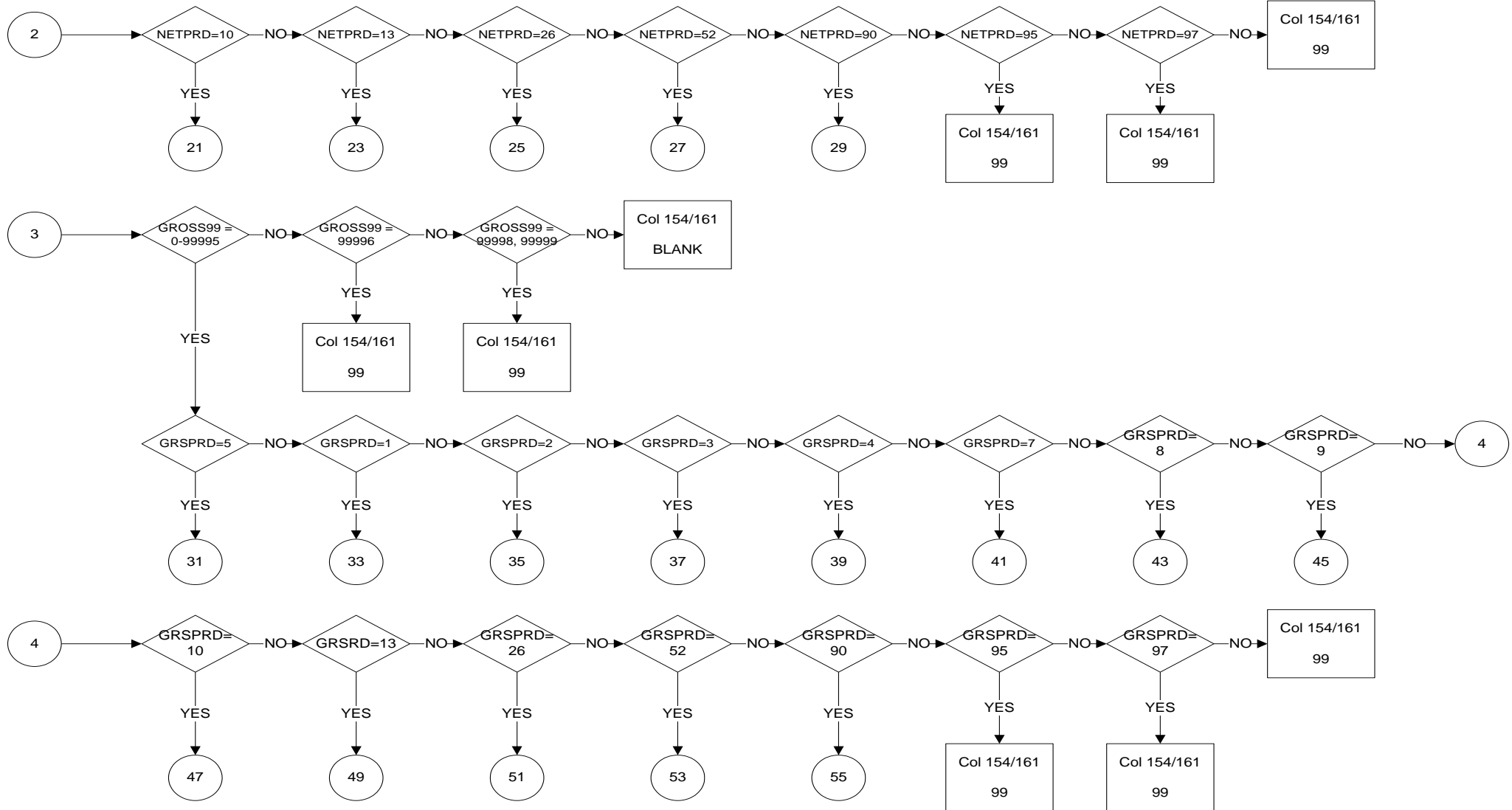

ENTMND: Monthly net (take home) pay from main job

Columns 154/155

PAGE 3 OF 15

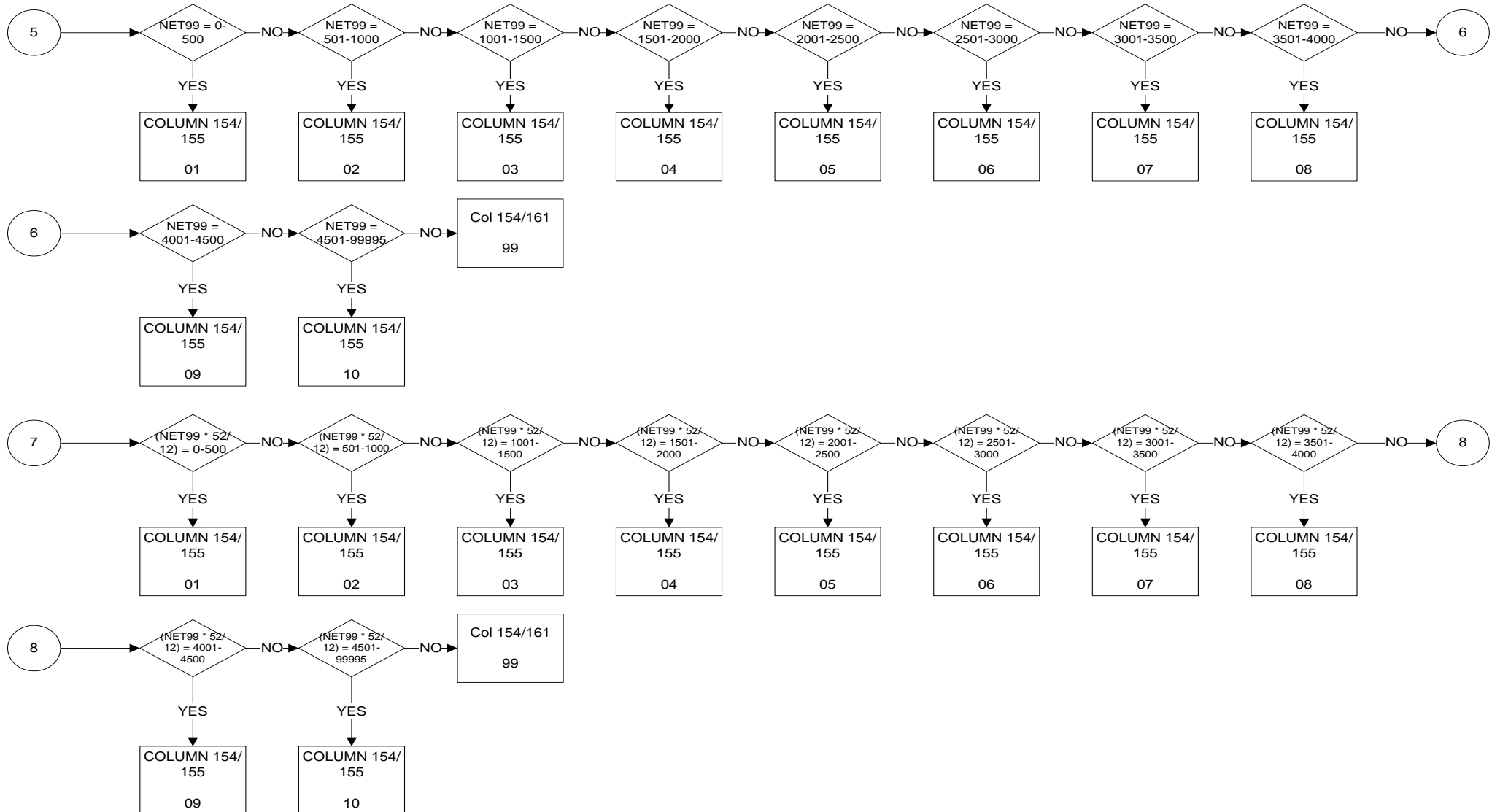

ENTMND: Monthly net (take home) pay from main job

Columns 154/155

PAGE 4 OF 15

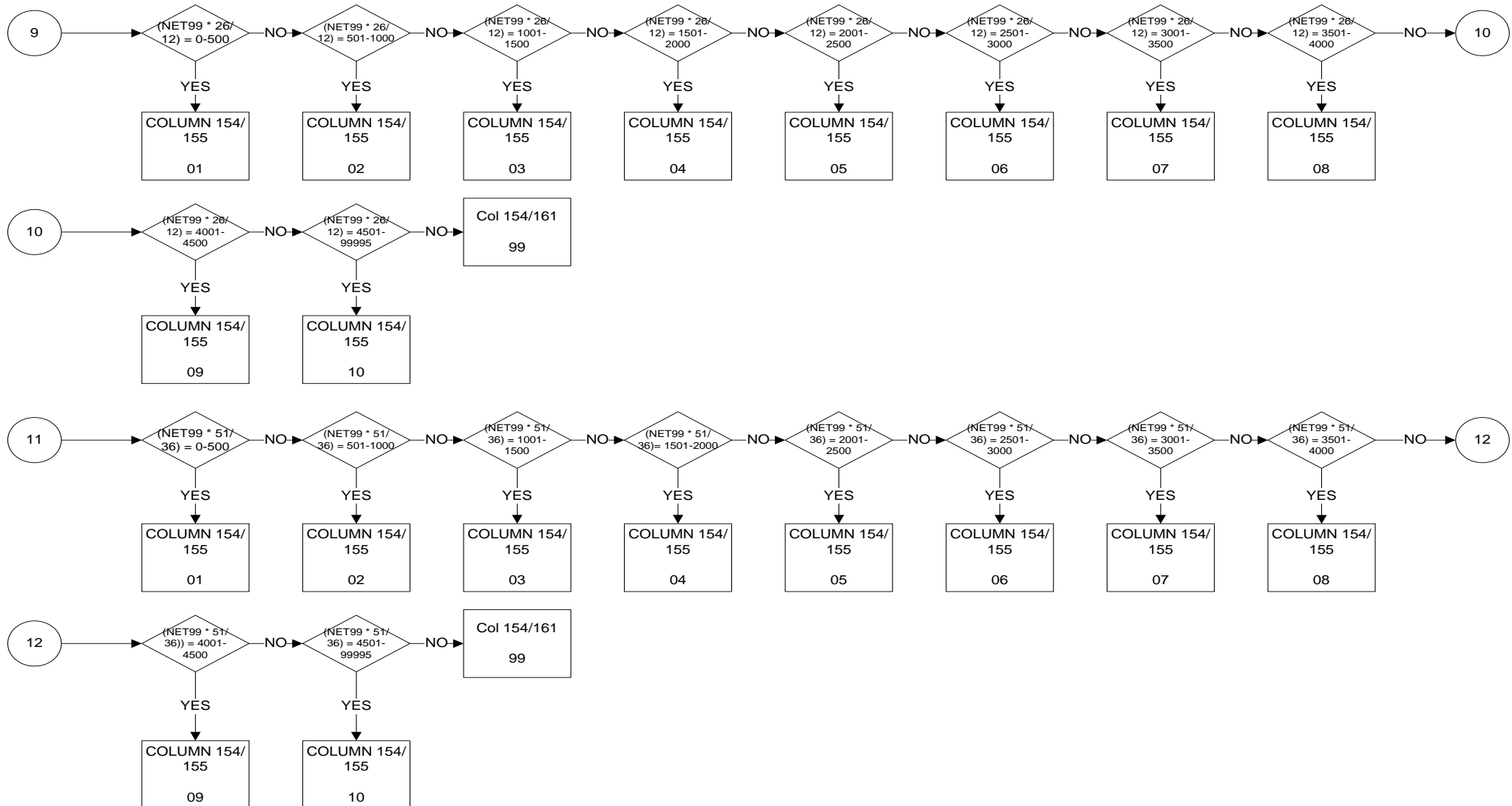

ENTMND: Monthly net (take home) pay from main job

Columns 154/155

PAGE 5 OF 15

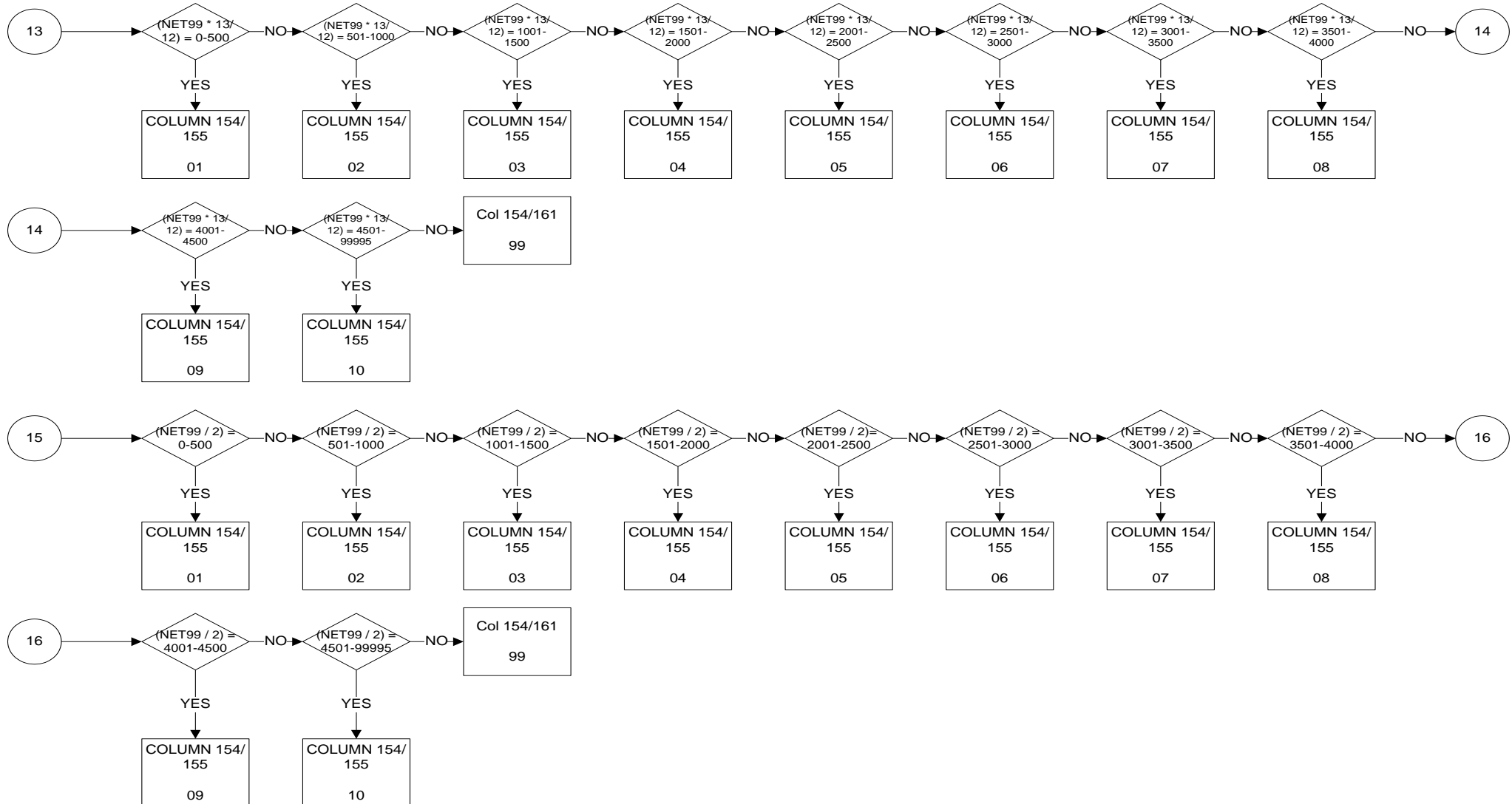

ENTMND: Monthly net (take home) pay from main job

Columns 154/155

PAGE 6 OF 15

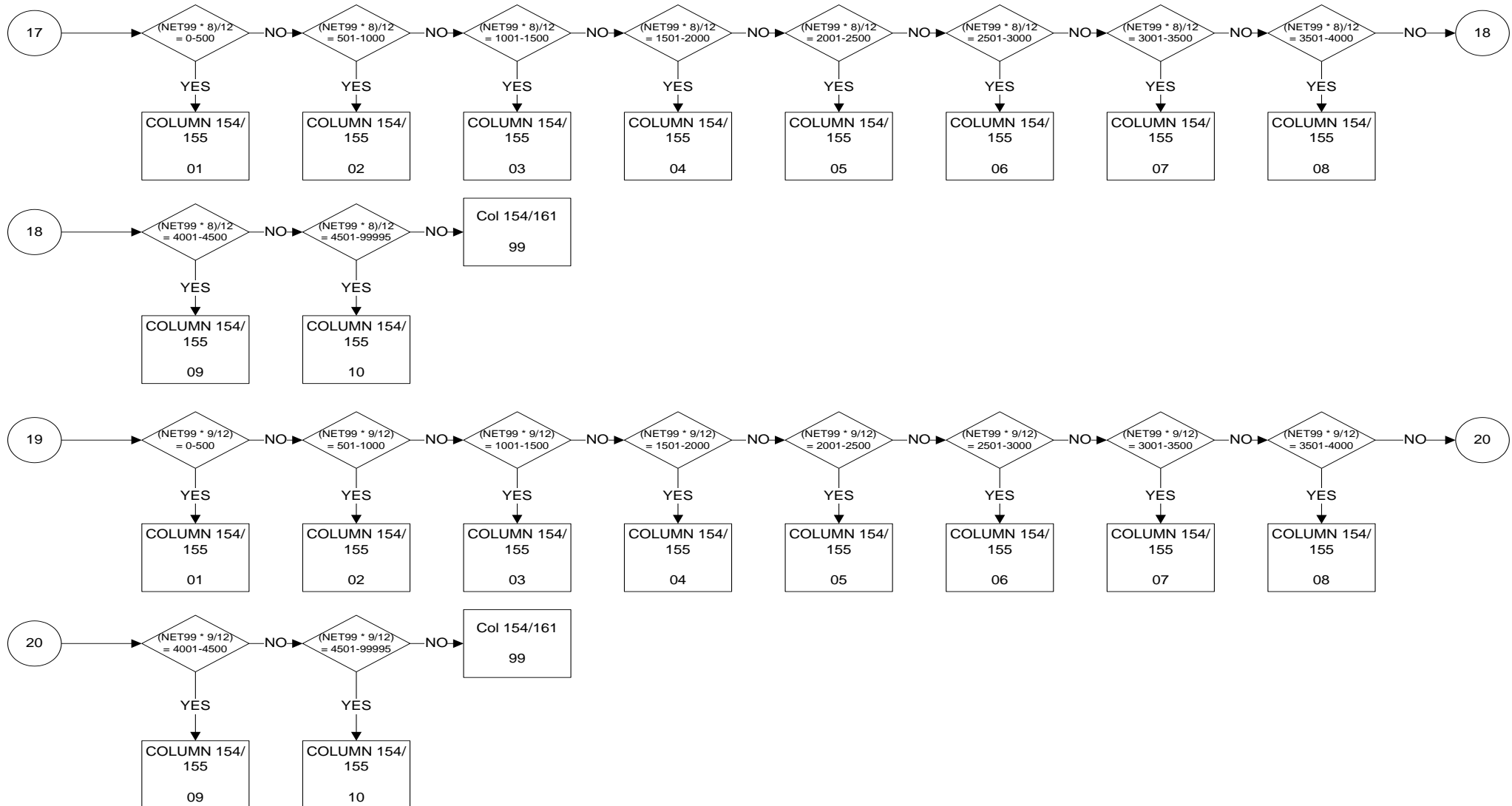

ENTMND: Monthly net (take home) pay from main job

Columns 154/155

PAGE 7 OF 15

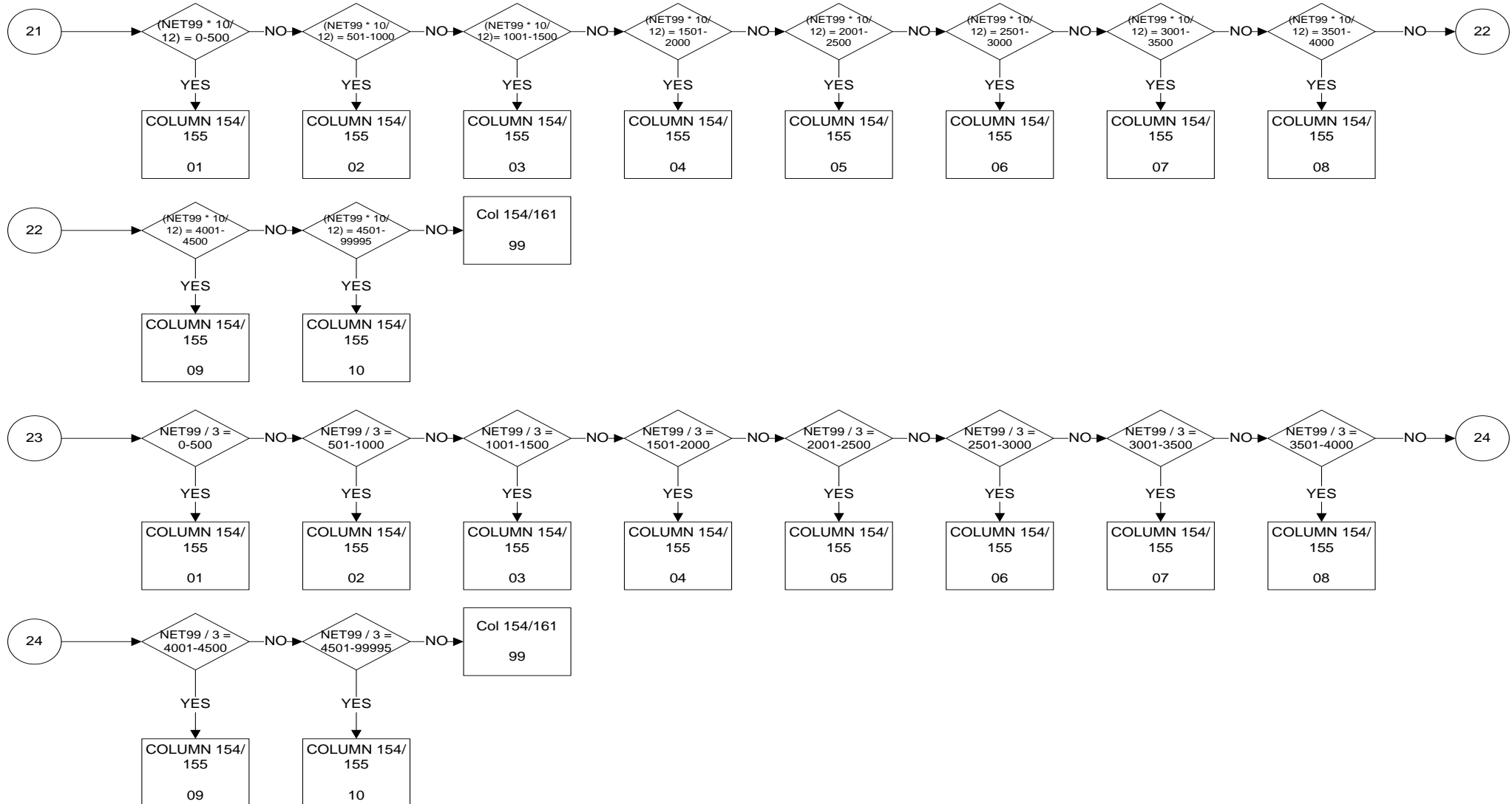

ENTMND: Monthly net (take home) pay from main job

Columns 154/155

PAGE 8 OF 15

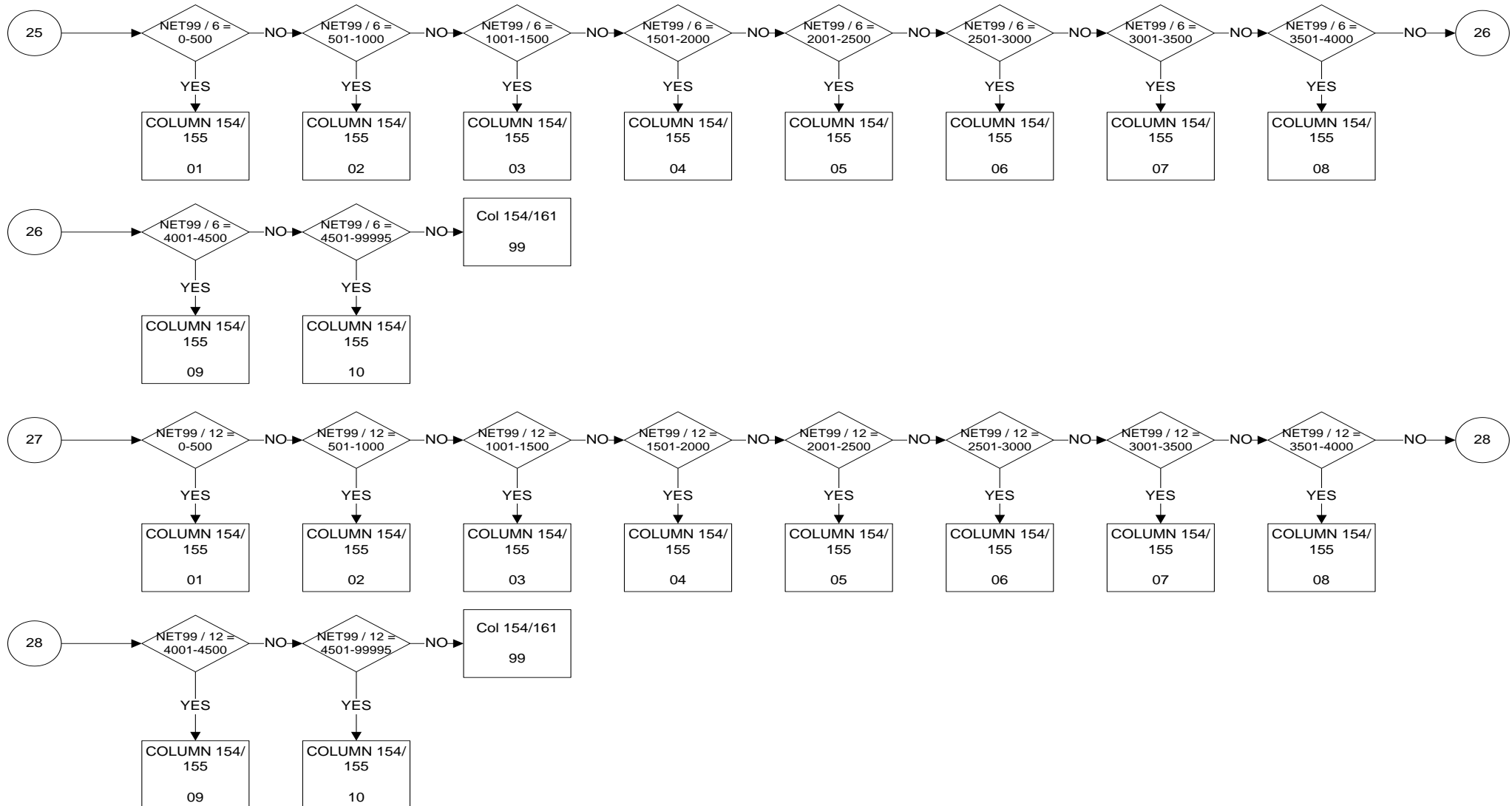

ENTMND: Monthly net (take home) pay from main job

Columns 154/155

PAGE 9 OF 15

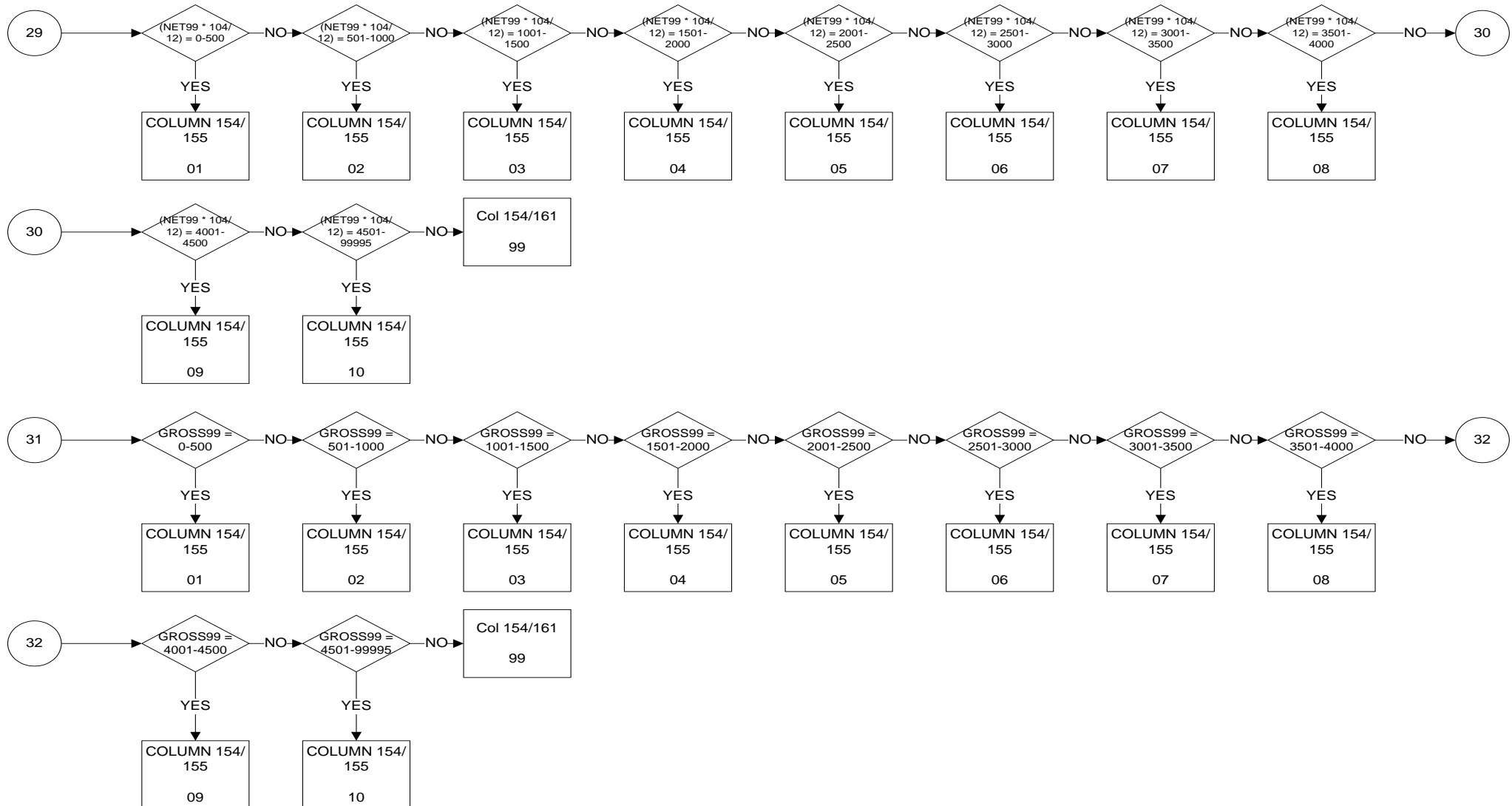

ENTMND: Monthly net (take home) pay from main job

Columns 154/155

PAGE 10 OF 15

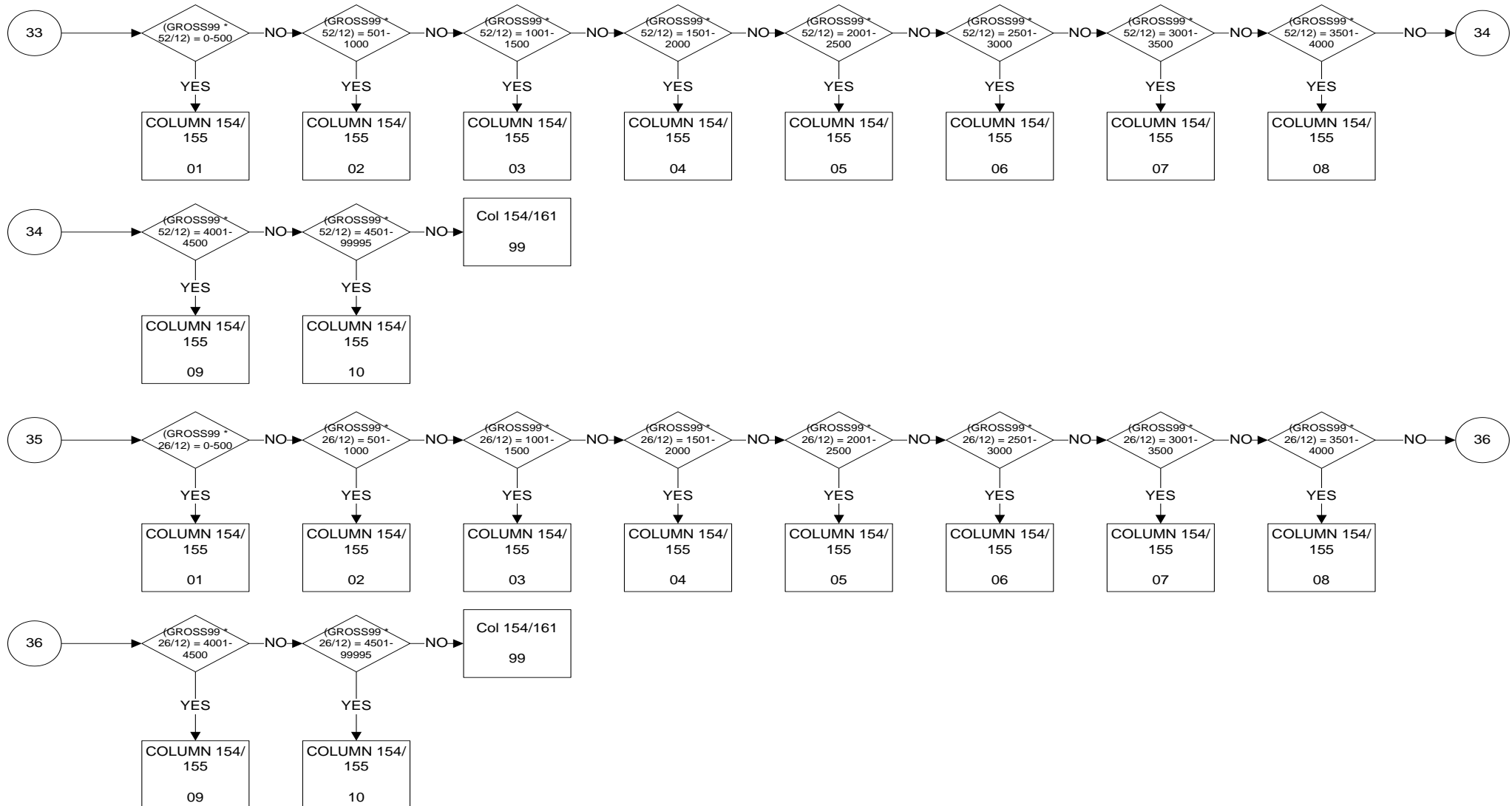

ENTMND: Monthly net (take home) pay from main job

Columns 154/155

PAGE 11 OF 15

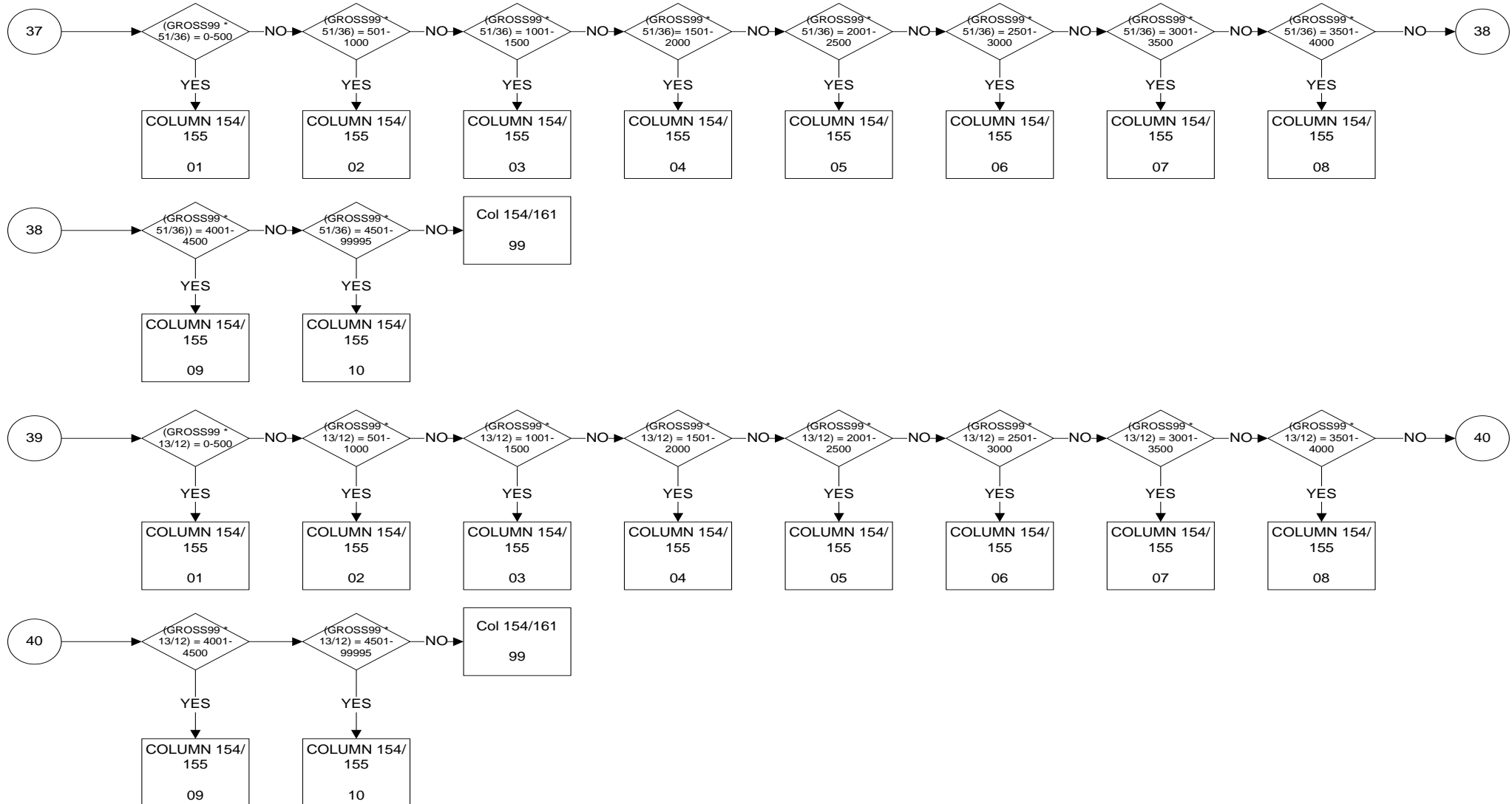

ENTMND: Monthly net (take home) pay from main job

Columns 154/155

PAGE 12 OF 15

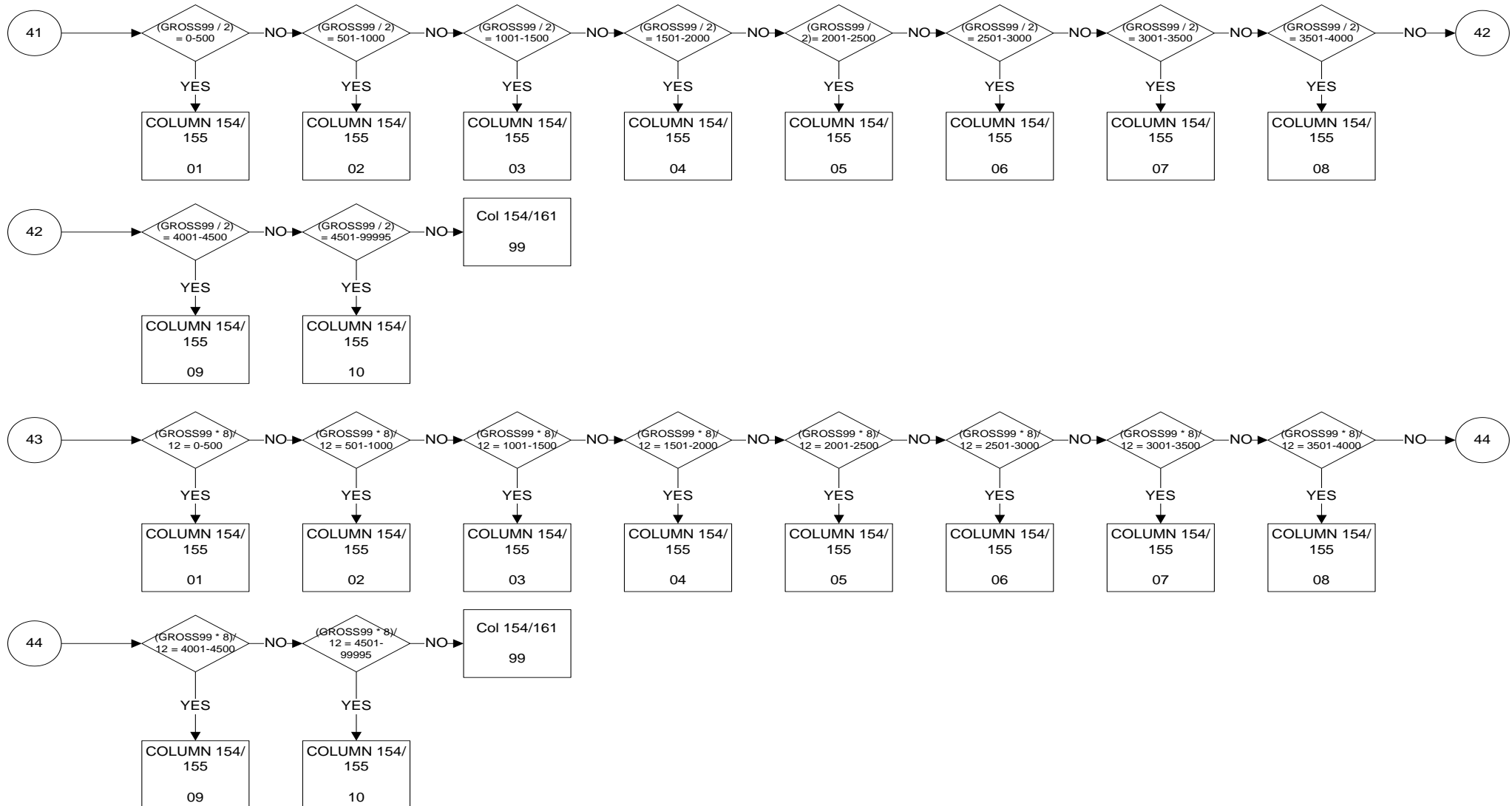

ENTMND: Monthly net (take home) pay from main job

Columns 154/155

PAGE 13 OF 15

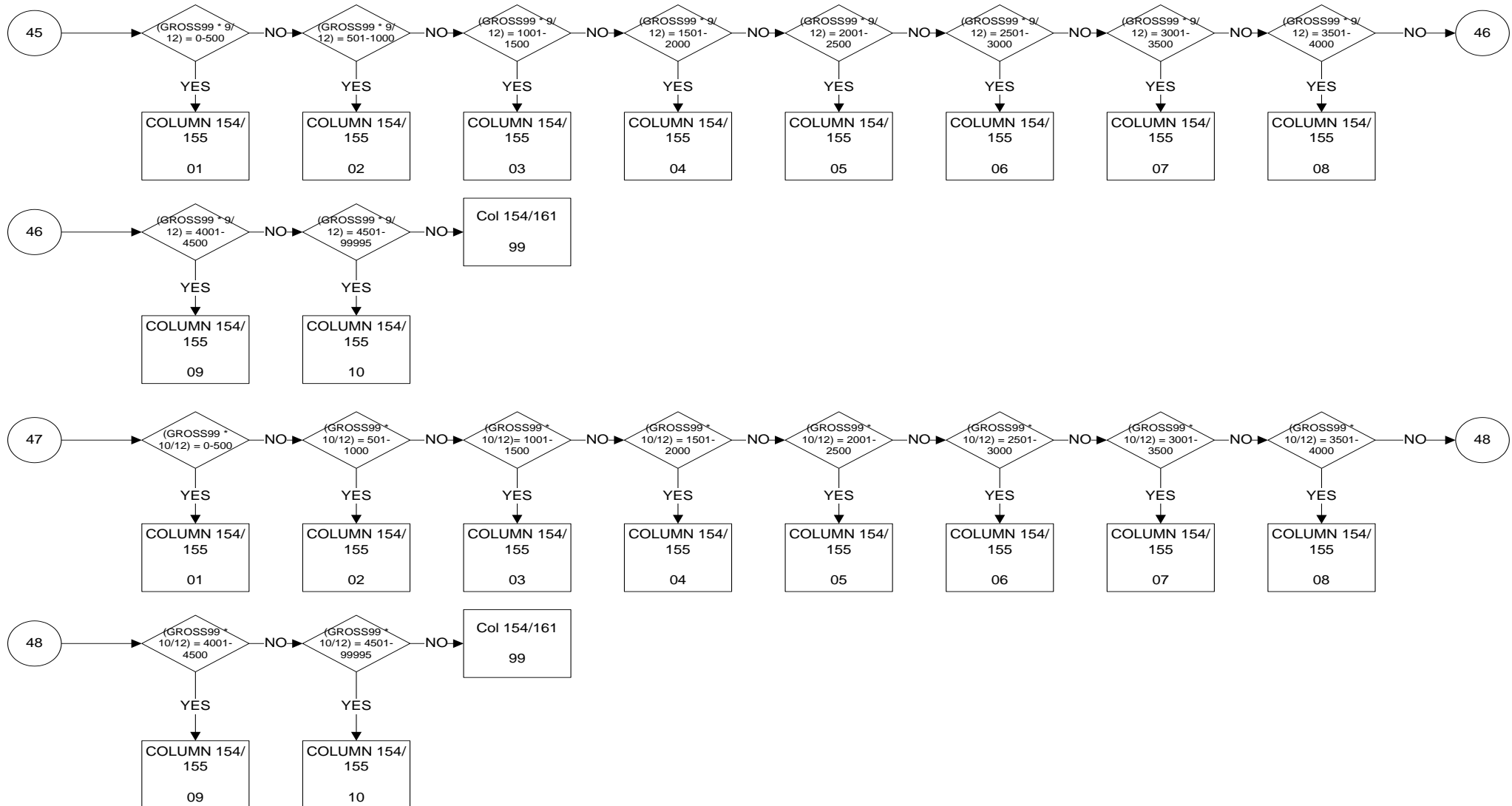

ENTMND: Monthly net (take home) pay from main job

Columns 154/155

PAGE 14 OF 15

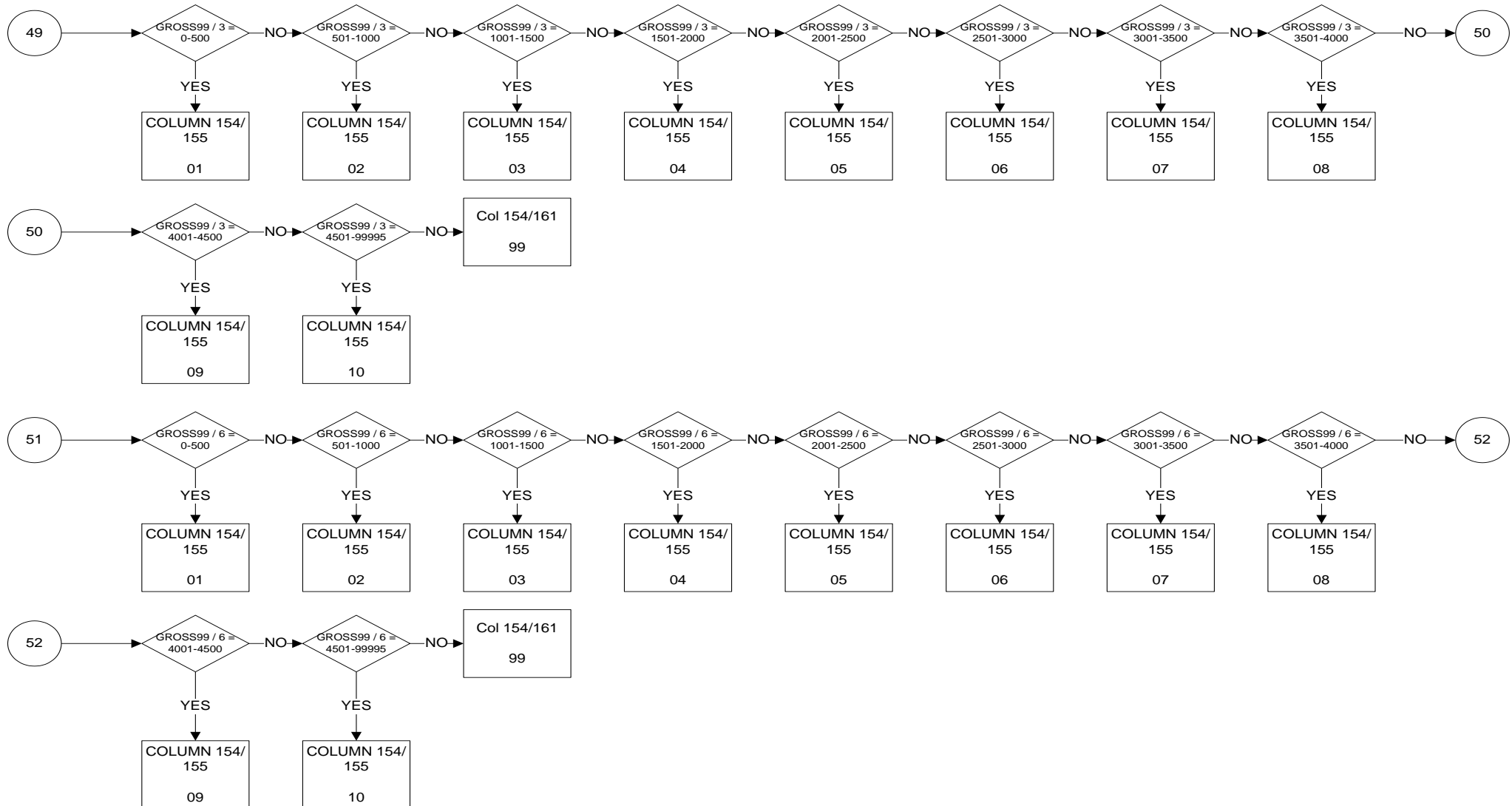

ENTMND: Monthly net (take home) pay from main job

Columns 154/155

PAGE 15 OF 15

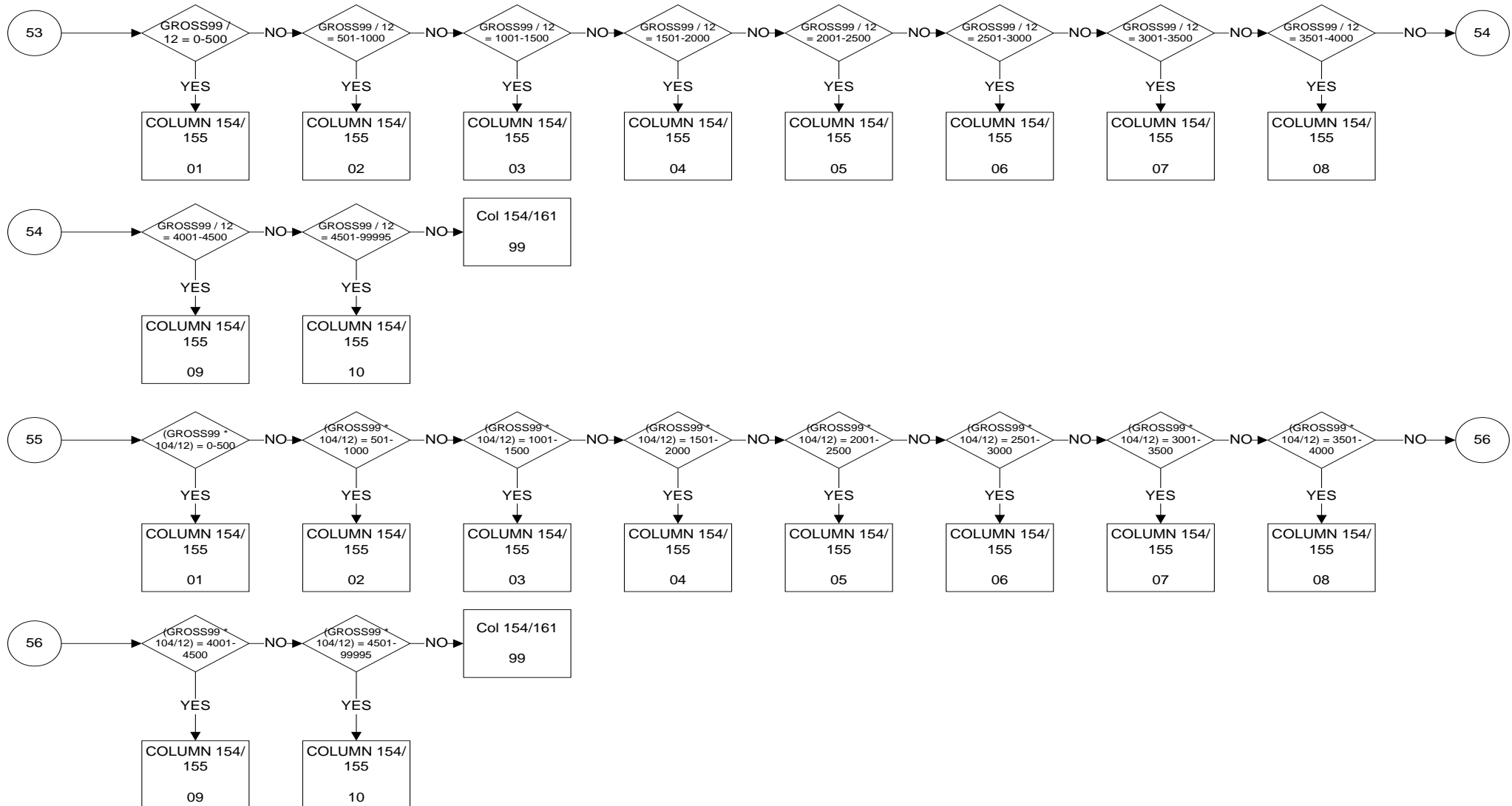

REFYEAR (EYEAR): Year of Survey

Columns 156/159

PAGE 1 OF 1

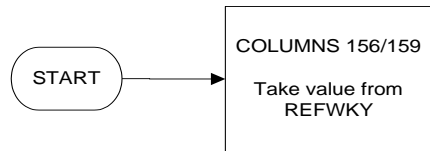

KEY

Year of survey
Last 4 digits of the year

REFWEEK (EREFWK): Reference week

Columns 160/161

PAGE 1 OF 1

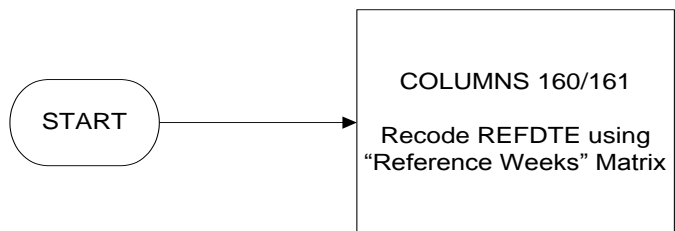

KEY

Number of the week running from Monday to Sunday

INTWEEK (EINTWK): Interview week

Columns 162/163

PAGE 1 OF 1

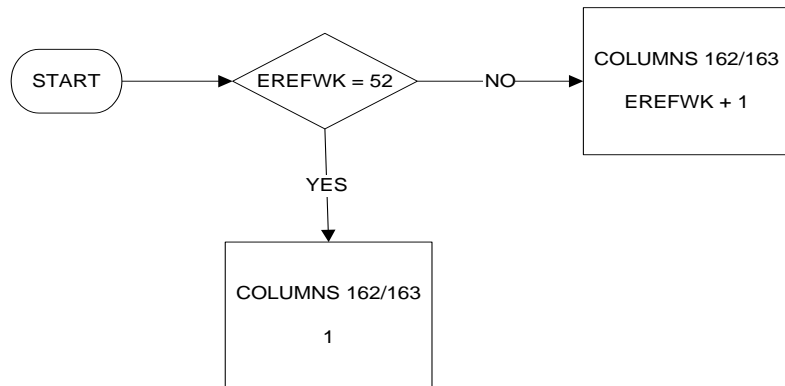

KEY

Number of the week running from Monday to Sunday

COUNTRY (ESTATE): Country

Column 164/165

PAGE 1 OF 1

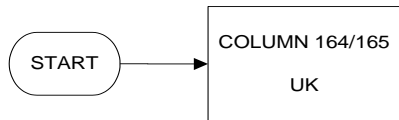

KEY

For coding, see ISO country classification

REGION (EREGN00): Region of household

Column 166/167

PAGE 1 OF 1

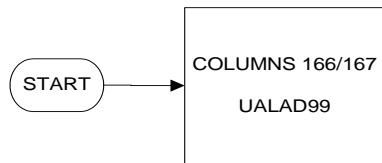

KEY
NUTS 2

DEGURBA (URBAN): Degree of urbanisation

Column 168
PAGE 1 OF 13

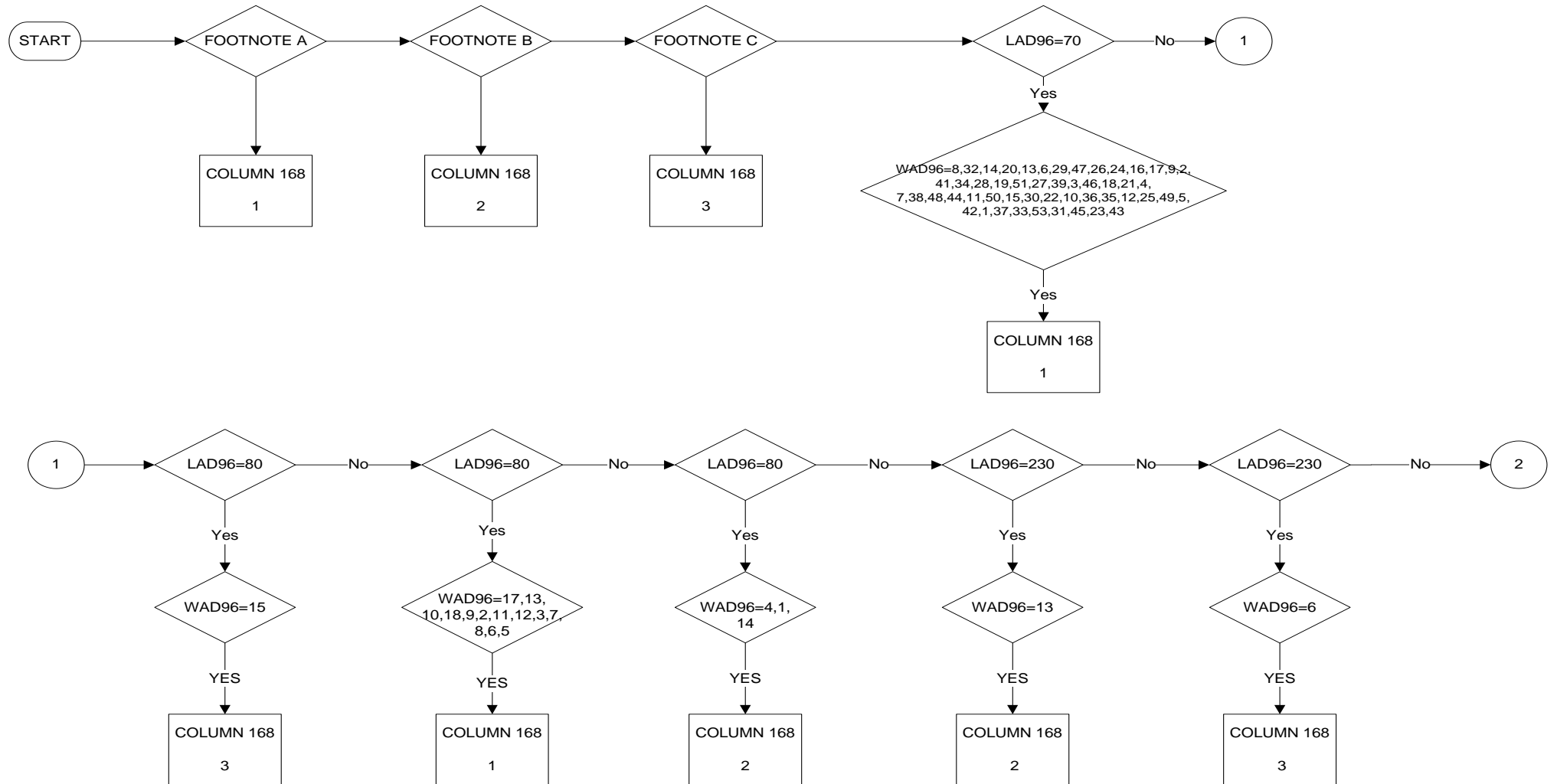

DEGURBA (URBAN): Degree of urbanisation

Column 168

PAGE 2 OF 13

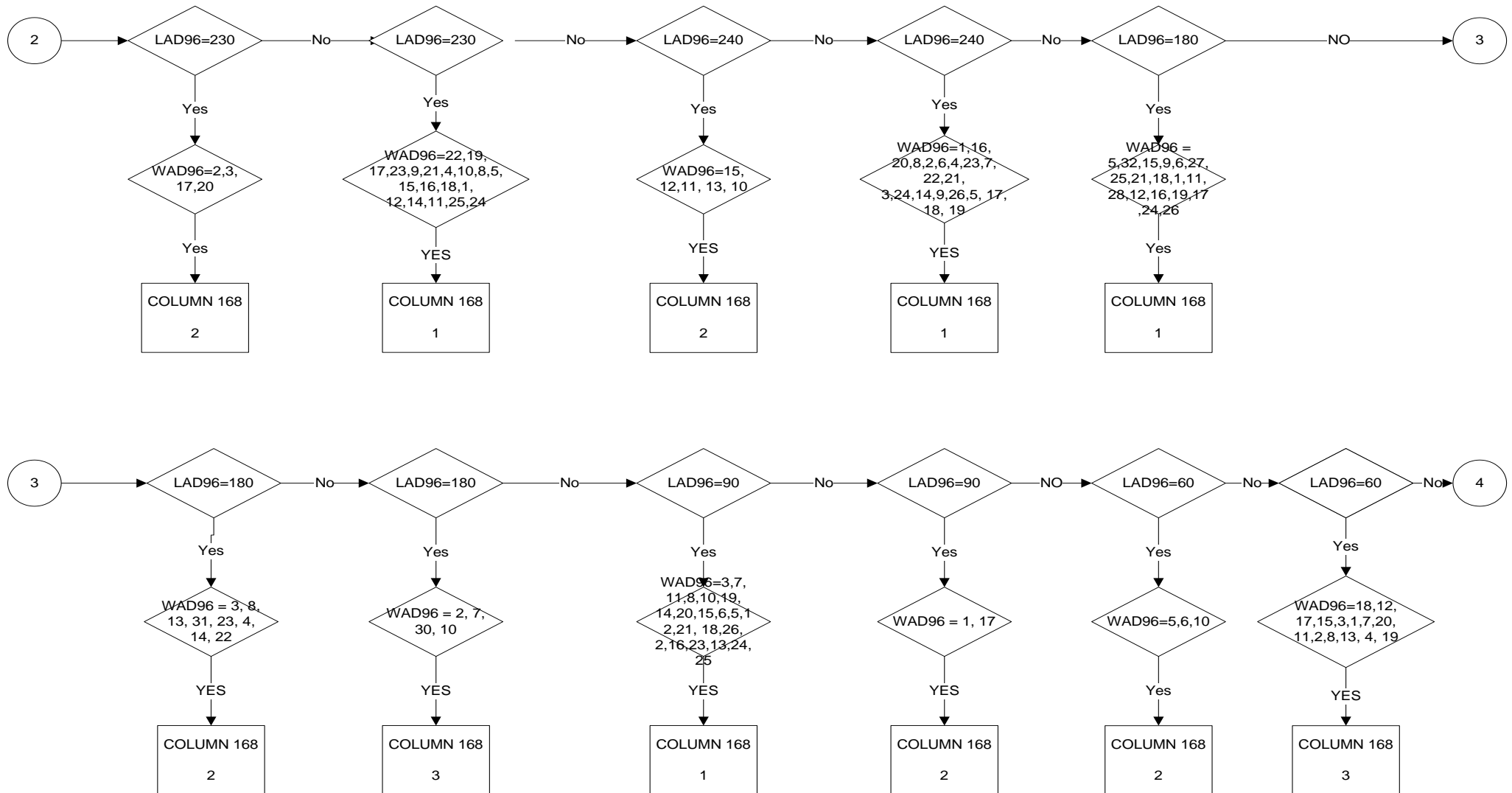

DEGURBA (URBAN): Degree of urbanisation

Column 168

PAGE 3 OF 13

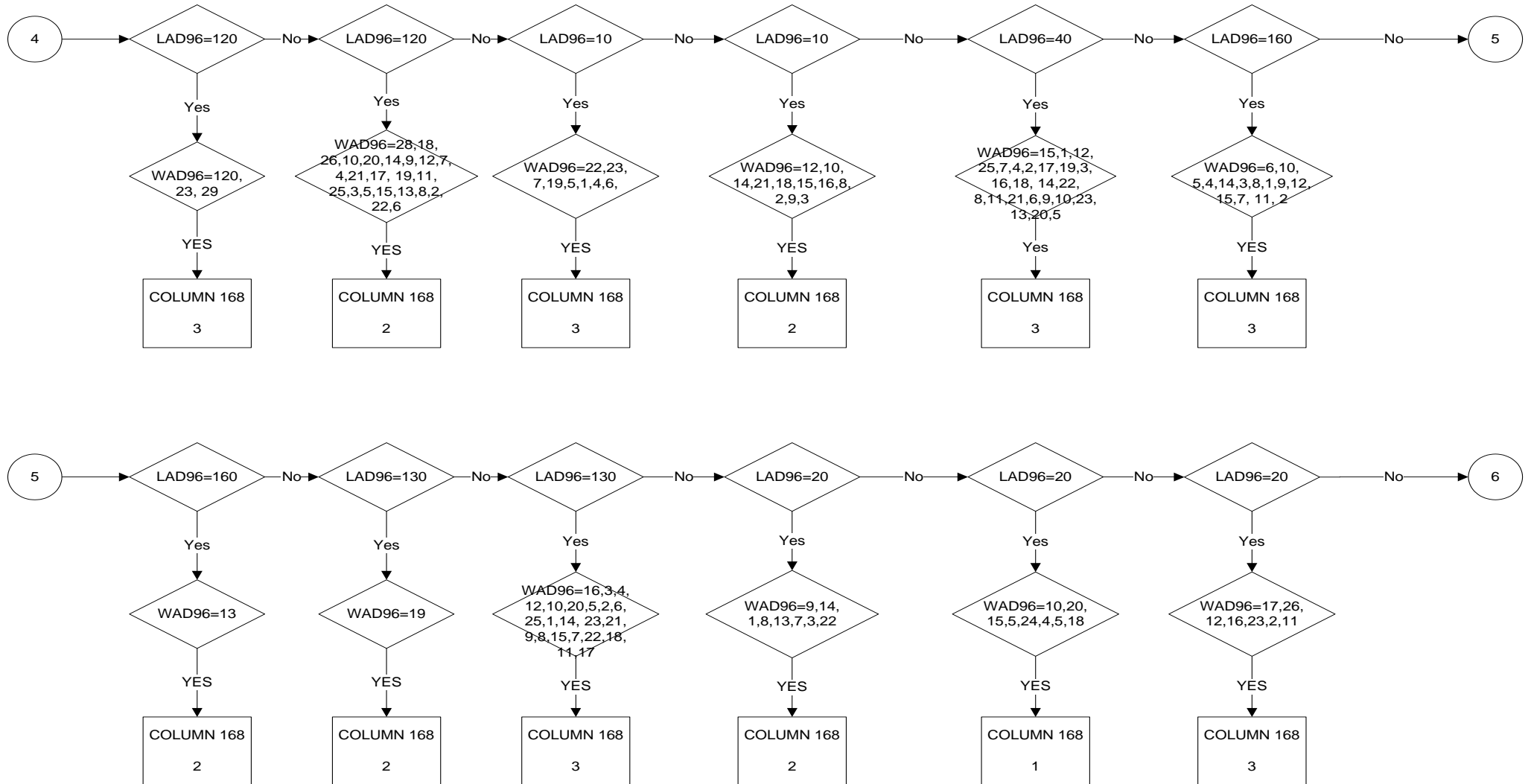

DEGURBA (URBAN): Degree of urbanisation

Column 168

PAGE 4 OF 13

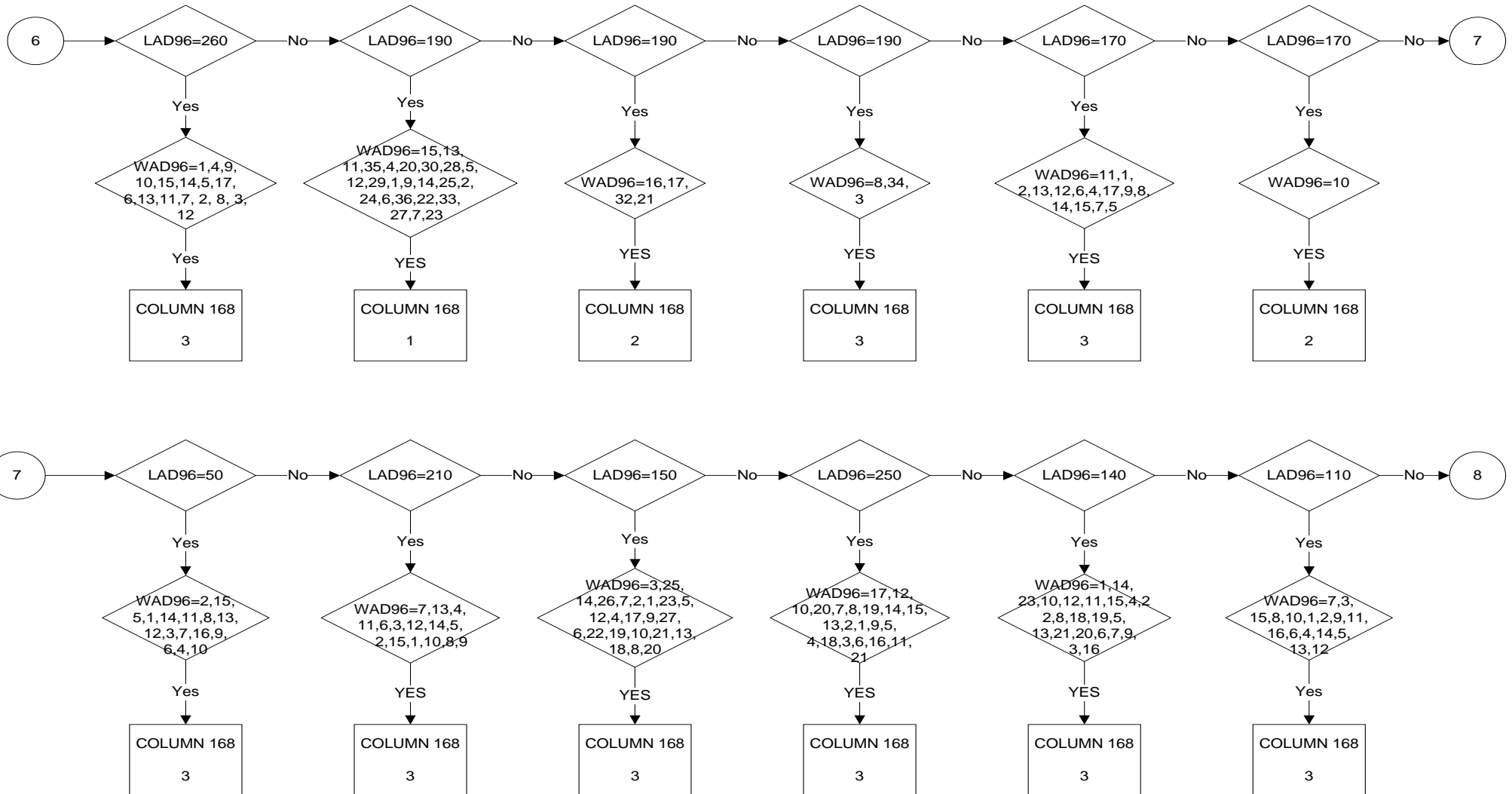

DEGURBA (URBAN): Degree of urbanisation

Column 168

PAGE 5 OF 13

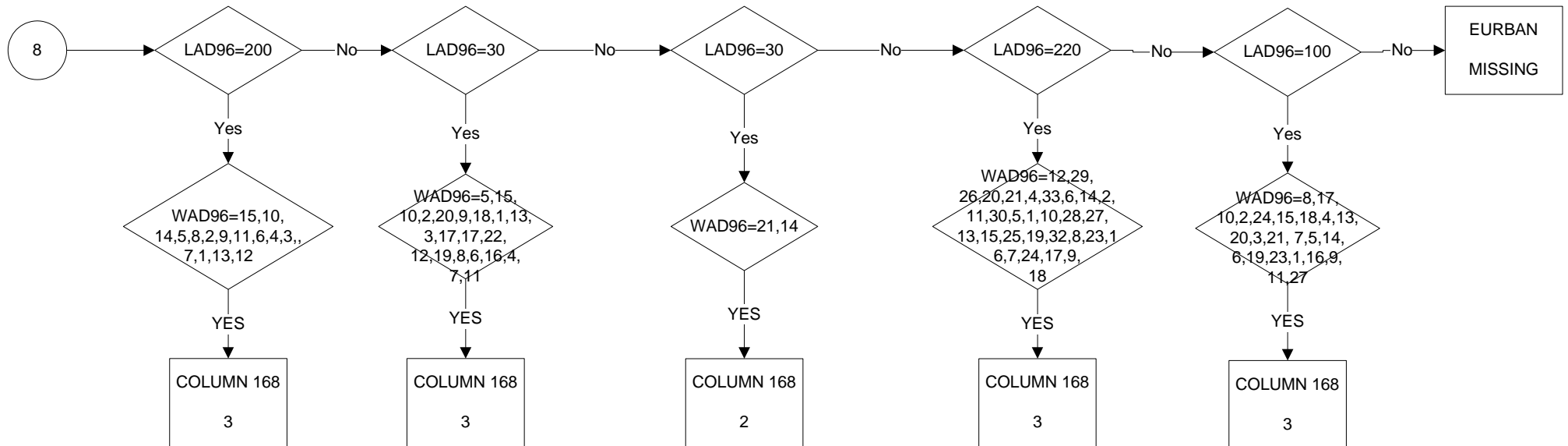

DEGURBA (URBAN): Degree of urbanisation

Column 168

PAGE 9 OF 13

FOOTNOTE A: CASWARD = 37UEGW, 37UEGX, 37UEGZ, 37UFFU, 37UFFX, 37UFFY, 37UFFZ, 37UFGA, 37UFGB, 37UFGC, 37UFGD, 37UFG E, 37UFGF, 37UFGH, 37UFGJ, 37UFGK, 37UFL, 37UFGM, 37UFGN, 37UFGP, 37UGHD, 37UJGG, 37UJGH, 37UJGJ, 37UJGK, 37UJGN, 37UJGP, 37UJGT, 37UJGW, 37UJGX, 37UJGY, 37UJGZ, 37UJHC, 37UJHJ, 38UCFT, 38UCFU, 38UCFW, 38UCFX, 38UCFY, 38UCFZ, 38UCGA, 38UCGB, 38UCGC, 38UCGD, 38UCGE, 38UCGF, 38UCGG, 38UCGH, 38UCGJ, 38UCGK, 38UCGL, 38UCGM, 38UCGN, 38UCGP, 38UCGQ, 38UCGR, 38UCGS, 38UCGT, 38UDHP, 38UEHC, 39UBGP, 39UEFX, 39UEGA, 39UEGB, 39UEGC, 39UEGD, 39UEGE, 39UEGF, 39UEGH, 39UEGK, 39UEGN, 39UEGP, 39UEGS, 39UEGX, 39UEGY, 39UEGZ, 40UEGH, 40UEGM, 40UEGX, 40UEGY, 40UEGZ, 40UEHA, 40UEHB, 40UEHC, 40UEHD, 40UEHE, 41UBFS, 41UBFT, 41UBFU, 41UBFW, 41UBFZ, 41UBGA, 41UBGB, 41UBGC, 41UBGD, 41UBGF, 41UCGD, 41UCGF, 41UCGG, 41UCGL, 41UCGN, 41UCGR, 41UCGS, 41UCGT, 41UCGY, 41UDGE, 41UDGH, 41UDGJ, 41UDGL, 41UDGM, 41UDGN, 41UDGP, 41UDGR, 41UDGS, 41UDGU, 41UDGX, 41UDHB, 41UDHE, 41UDHF, 41UEGB, 41UEGC, 41UED, 41UEGE, 41UEGF, 41UEGH, 41UEGK, 41UEGL, 41UEGP, 41UEGQ, 41UEGR, 41UEGS, 41UEGT, 41UEGU, 41UEGW, 41UEGX, 41UEGY, 41UEGZ, 41UEHA, 41UFHM, 41UFHQ, 41UFHR, 41UFHS, 41UFHU, 41UFHW, 41UFHX, 41UFJG, 41UFJH, 41UGGJ, 41UGGM, 41UGGN, 41UGGQ, 41UGGU, 41UGGW, 41UGGX, 41UGGY, 41UGHB, 41UGHC, 41UGHH, 41UGHK, 41UHGH, 41UHJ, 41UHGM, 41UHGO, 41UHGZ, 41UHHJ, 41UKFL, 41UKFM, 41UKFN, 41UKFP, 41UKFQ, 41UKFR, 41UKFS, 41UKFT, 41UKFU, 41UKFW, 42UBHF, 42UDFS, 42UDFT, 42UDFU, 42UDFW, 42UDFX, 42UDFY, 42UDFZ, 42UDGA, 42UDGB, 42UDGC, 42UDGD, 42UDGE, 42UDGF, 42UDGG, 42UDGH, 42UDGJ, 42UGHJ, 42UGHK, 42UGHX, 42UHGC, 42UHGD, 42UHGE, 42UHGG, 42UHGJ, 42UHGL, 42UHGM, 42UHGN, 42UHGP, 42UHGO, 42UHGU, 43UBFZ, 43UBGA, 43UBGB, 43UBGC, 43UBGD, 43UBGE, 43UBGF, 43UBGG, 43UBGH, 43UBGJ, 43UBGK, 43UBGL, 43UBGM, 43UBGN, 43UBGP, 43UBGQ, 43UBGR, 43UBGS, 43UBGT, 43UBGU, 43UBGW, 43UBGX, 43UCFP, 43UCFQ, 43UCFR, 43UCFS, 43UCFT, 43UCFU, 43UCFW, 43UCFX, 43UCFY, 43UCFZ, 43UCGA, 43UCGB, 43UCGC, 43UDFY, 43UDFZ, 43UDGA, 43UDGB, 43UDGC, 43UDGF, 43UDGG, 43UDGJ, 43UDGL, 43UDGP, 43UDGR, 43UDGS, 43UDGU, 43UEGA, 43UEGB, 43UEGC, 43UEGE, 43UEGF, 43UEGN, 43UEGP, 43UEGR, 43UEGS, 43UFFU, 43UFFX, 43UFFY, 43UFFZ, 43UFGA, 43UFGC, 43UFGD, 43UFG E, 43UFGF, 43UFGG, 43UFGH, 43UFGJ, 43UFGK, 43UFGM, 43UFGN, 43UFGP, 43UFGQ, 43UFGR, 43UGFS, 43UGFT, 43UGFU, 43UGFW, 43UGFX, 43UGFY, 43UGFZ, 43UGGB, 43UGGC, 43UGGE, 43UHFS, 43UHFT, 43UHFU, 43UHFW, 43UHFX, 43UHFY, 43UHFZ, 43UHGA, 43UHGB, 43UHGC, 43UHGD, 43UHGE, 43UHGF, 43UJFS, 43UJFT, 43UJFW, 43UJFX, 43UJFY, 43UJFZ, 43UJGA, 43UJGB, 43UJGC, 43UJGD, 43UJGE, 43UJGF, 43UJGG, 43UKGE, 43UKGK, 43UKGL, 43UKGN, 43UKGQ, 43UKGR, 43UKGS, 43ULGP, 43ULGQ, 43ULGR, 43ULGS, 43ULGT, 43ULGU, 43ULGW, 43ULGX, 43ULGY, 43UMFT, 43UMFU, 43UMFW, 43UMFX, 43UMFY, 43UMFZ, 43UMGA, 43UMGB, 43UMGC, 43UMGE, 43UMGF, 43UMGG, 43UMGH, 43UMGJ, 43UMGK, 44UBGJ, 44UBGL, 44UBGM, 44UBGN, 44UCFR, 44UCFT, 44UCFU, 44UCFW, 44UCFY, 44UCFZ, 44UCGA, 44UCGB, 44UCGC, 44UCGD, 44UCGE, 44UCGF, 44UCGG, 44UCGH, 44UCGJ, 44UDFZ, 44UDGB, 44UDGC, 44UDGD, 44UDGE, 44UDGF, 44UDGJ, 44UDGL, 44UDGP, 44UDGQ, 44UDGR, 44UDGS, 44UEHQ, 44UFFZ, 44UFGB, 44UFGC, 44UFGG, 44UFGH, 44UFGN, 44UFGP, 44UFGQ, 44UFGR, 44UFGS, 45UBFQ, 45UBFR, 45UBFS, 45UBFT, 45UBFU, 45UBFW, 45UBFX, 45UBFY, 45UBFZ, 45UBGA, 45UBGB, 45UBGC, 45UBGD, 45UBGE, 45UCGE, 45UCGF, 45UCGK, 45UCGL, 45UCGM, 45UCGN, 45UCGP, 45UCGQ, 45UCGR, 45UCGT, 45UCGU, 45UCGW, 45UCGX, 45UCGY, 45UCGZ, 45UCHA, 45UCHB, 45UCHC, 45UCHD, 45UCHF, 45UDHM, 45UEFP, 45UEFQ, 45UEFR, 45UEFS, 45UEFT, 45UEFU, 45UEFW, 45UEFX, 45UEFY, 45UEFZ, 45UEGA, 45UEGB, 45UEGC, 45UEGD, 45UEGE, 45UFG E, 45UFGJ, 45UFGK, 45UFGM, 45UFGN, 45UFGP, 45UFGT, 45UFGU, 45UFGY, 45UFHA, 45UHFN, 45UHFP, 45UHFQ, 45UHFR, 45UHFS, 45UHFT, 45UHFU, 45UHFW, 45UHFX, 45UHFY, 45UHFZ, 45UHGA, 45UHGB, 47UBFZ, 47UBGA, 47UBGB, 47UBGC, 47UBGE, 47UBGG, 47UBGJ, 47UBGK, 47UBGL, 47UBGM, 47UBGN, 47UBGP, 47UBGT, 47UBGU, 47UDFM, 47UDFP, 47UDFQ, 47UDFR, 47UDFS, 47UDFT, 47UDFU, 47UDFW, 47UDFX, 47UDFY, 47UDFZ, 47UEFN, 47UEFP, 47UEFQ, 47UEFR, 47UEFS, 47UEFT, 47UEFU, 47UEFW, 47UEFX, 47UEFY, 47UEFZ, 47UEGA, 47UEGB, 47UEGC, 47UEGD, 47UGFU, 47UGFW, 47UGFZ, 47UGGB, 47UGGC, 47UGGD, 47UGGE, 47UGGF, 47UGGG, 47UGGH, 47UGGK

HHNUM (ESERIAL): Serial number of household

Columns 169/174

PAGE 1 OF 1

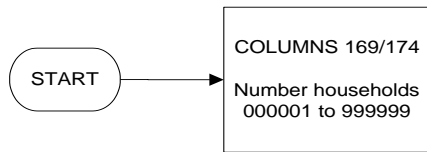

KEY

Serial number are allocated by the national statistical institutes and remain the same for all waves

HHTYPE (ETYPHLD): Type of Household

Column 175

PAGE 1 OF 1

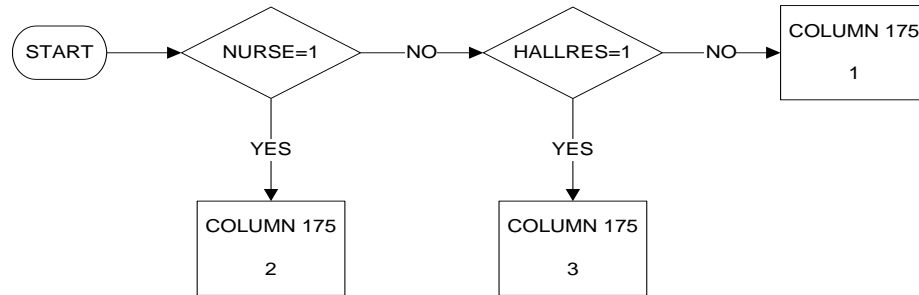

KEY

- 1 Person living in private household (or permanently in a hotel) and surveyed in this household
- 2 Person living in an institution and surveyed in this institution
- 3 Person living in an institution but surveyed in this private household
- 4 Person living in another private household on the territory of the country but surveyed in this household of origin

HHTYPE (ETYPHLD): Type of Household

Column 175

PAGE 1 OF 1

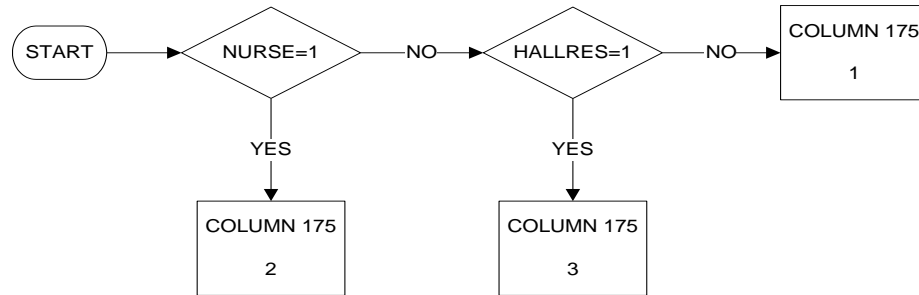

KEY

- 1 Person living in private household (or permanently in a hotel) and surveyed in this household
- 2 Person living in an institution and surveyed in this institution
- 3 Person living in an institution but surveyed in this private household
- 4 Person living in another private household on the territory of the country but surveyed in this household of origin

HHINST (ETYPINS): Type of Institution

Column 176

PAGE 1 OF 1

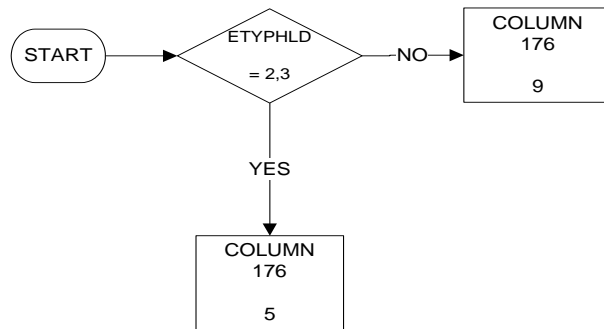

KEY

1	Educational institution
2	Hospital
3	Other welfare institution
4	Religious institution (not already included in 1-3)
5	Workers' hostel, working quarters at building sites, student hostel, university accommodation etc.
6	Military establishment
7	Other (e.g. prison)
9	Not applicable (HHTYPE = 1,4)
BLANK	No answer

COEFFY (EWEIGHT): Yearly weighting factor

Columns 177/182

PAGE 1 OF 1

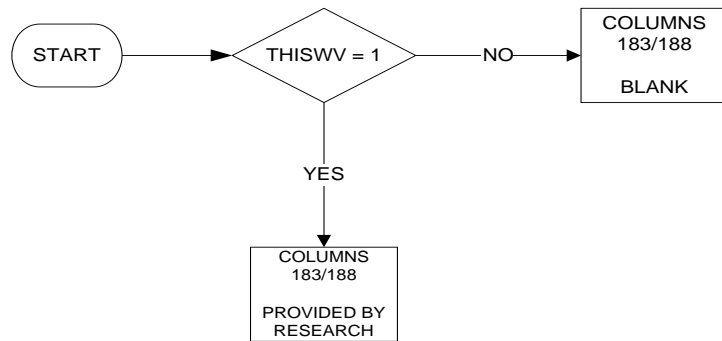

KEY

0000-9999 Cols 183-186 contain whole numbers
00-99 Cols 187-188 contain decimal places

Notes

The yearly weighting factor is provided by research by an annual weight calculated once all quarter data has been received.

COEFFQ (EQWT07): Quarterly weighting factor

Columns 183/188

PAGE 1 OF 1

START

COLUMNS 183/188

The SOEC file quarterly weighting factor will be the same as the UK file. Factor in the format XXXX.XX

KEY

0000-9999 Cols 183-186 contain whole numbers
00-99 Cols 187-188 contain decimal places

COEFFH (EQHWT): Household yearly weighting factor of the sample for household characteristics (in the case of a sample of individuals)

Columns 189/194

PAGE 1 OF 1

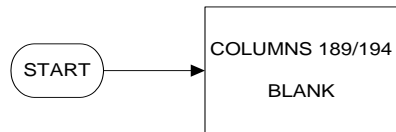

KEY

0000-9999 Cols 189-192 contain whole numbers
00-99 Cols 193-194 contain decimal places

Notes

No weight is submitted to Eurostat

INTWAVE (EWAVE): Sequence number of the survey wave

Column 195

PAGE 1 OF 1

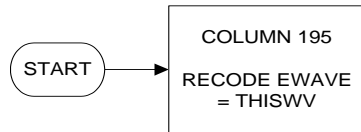

KEY	
1-8	Sequence number of the wave

INTQUEST (EINTQUES): Questionnaire used

Column 196
PAGE 1 OF 1

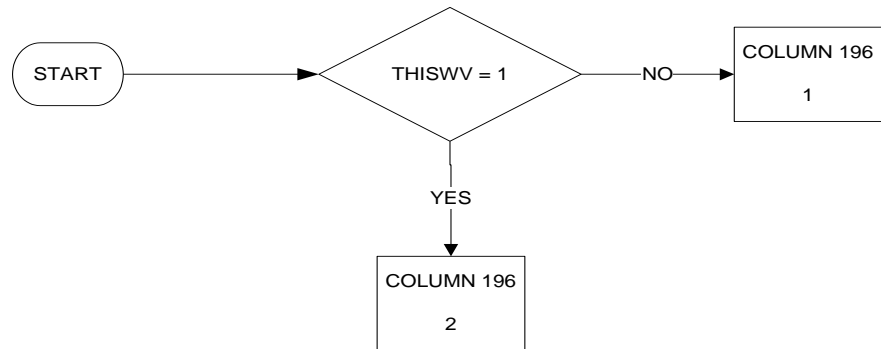

KEY

- 1 Only core variables
- 2 Whole questionnaire

Notes

This variable indicates which cases should be used for creating data on Eurostat structural variables. As this data is collected in wave 1 all quarters it is only wave one cases that can be used with the wave 1 weight (COEFFY, Col. 177-182) to generate this data. Eurostat specify that the records for which yearly variables are available should be coded as INTQUEST (Col. 196) = 2 and the records for which only quarterly variables are available should be coded as INTQUEST = 1.

HATLEVEL (EHATLEV14) Educational attainment level (ISCED11)
Cols 197/199

Start date: 2014 Q1
End date: 2014 Q4

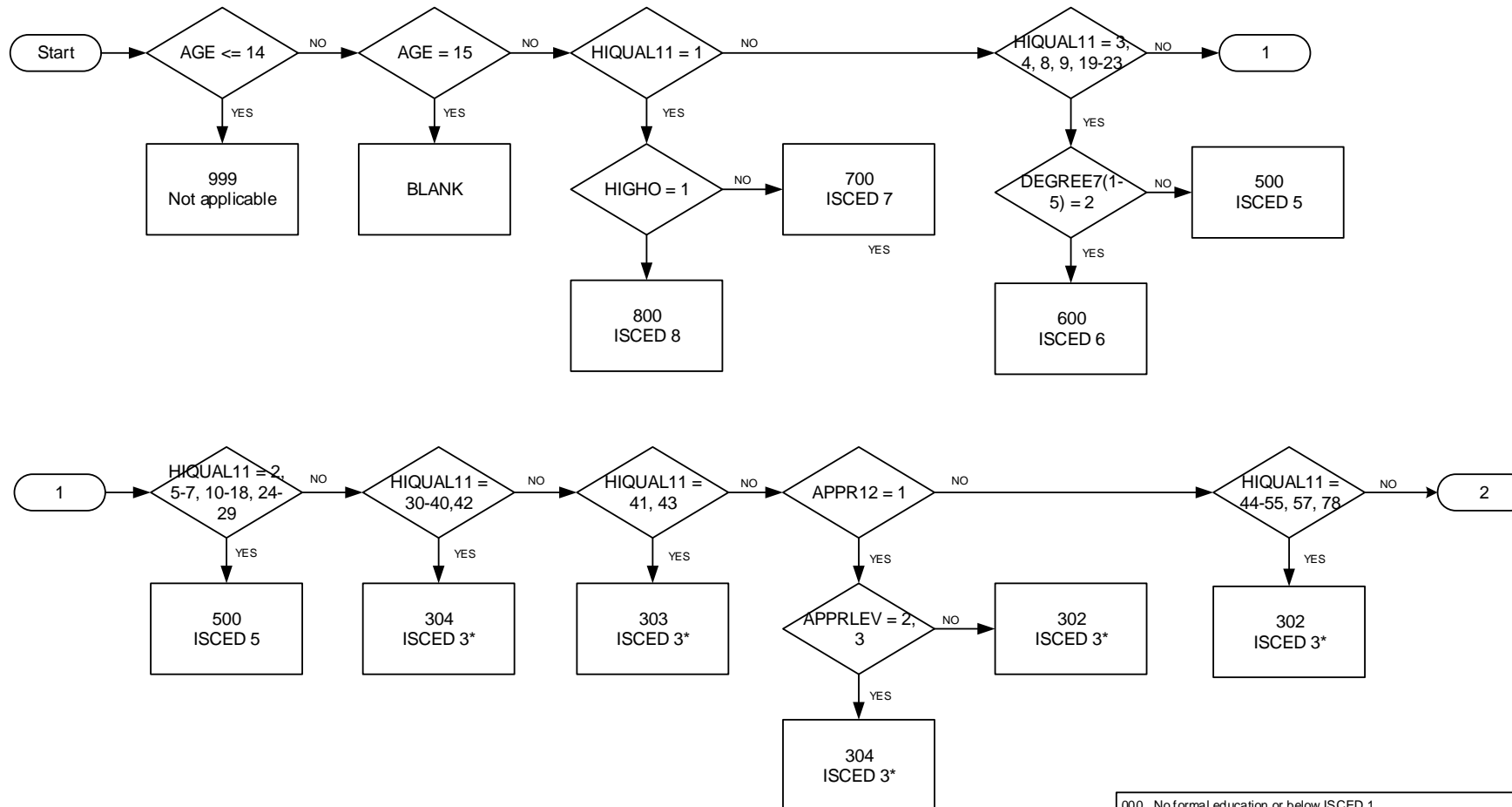

000	No formal education or below ISCED 1
100	ISCED 1
200	ISCED 2 (inc ISCED 3 programmes of duration less than 2 years)
302	ISCED 3 programme duration >= 2 years, sequential (i.e. access to next ISCED 3 programme only)
303	ISCED 3 programme duration >= 2 years, terminal or access to next ISCED 4 only (N/A in UK)
304	ISCED 3 with access to ISCED 5, 6 or 7
400	ISCED 4 (N/A in UK)
500	ISCED 5
600	ISCED 6
700	ISCED 7
800	ISCED 8
999	Not applicable (age < 15)

To 2013 Q4 see HATLEVEL (EHATLEV) cols 137-138
From 2015 Q1 to Q4 see HATLEVEL (EHATLEV15) cols 197-199
From 2016 Q1 see HATLEVEL (EHATLEV16) cols 197-199

HATLEVEL (EHATLEV14) Educational attainment level (ISCED11)
 Cols 197/199

Start date: 2014 Q1
 End date: 2014 Q4

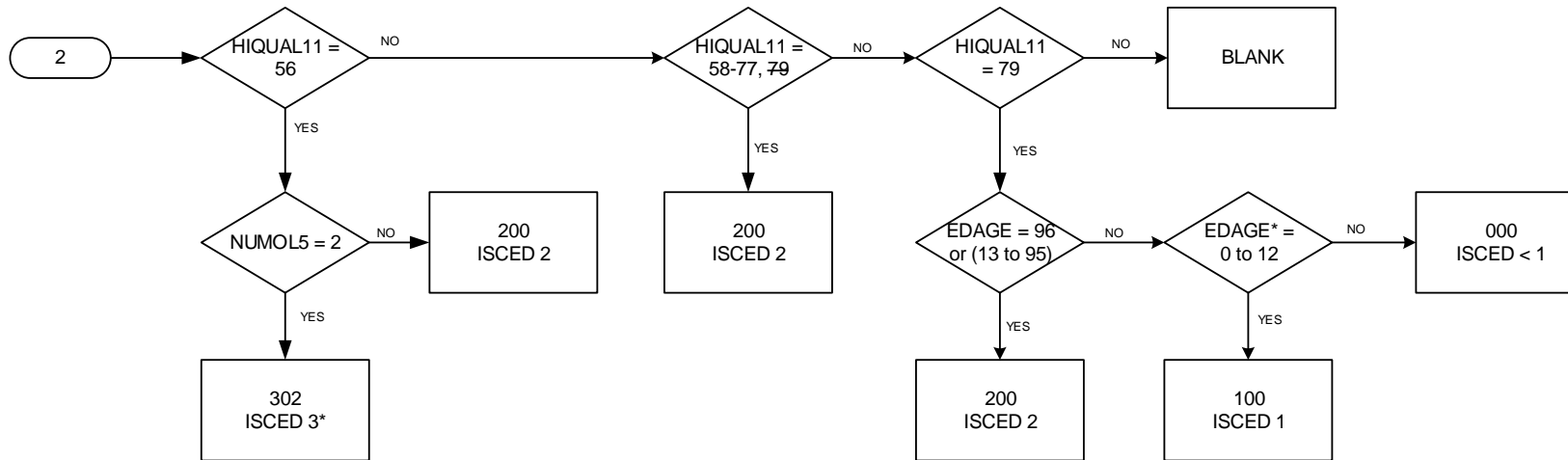

Note regarding EDAGE – Age when completed continuous full-time education.
 0 to 95 = age
 96 = still in education
 97 = never had education

000	No formal education or below ISCED 1
100	ISCED 1
200	ISCED 2 (inc ISCED 3 programmes of duration less than 2 years)
302	ISCED 3 programme duration >= 2 years, sequential (i.e. access to next ISCED 3 programme only)
303	ISCED 3 programme duration >= 2 years, terminal or access to next ISCED 4 only (N/A in UK)
304	ISCED 3 with access to ISCED 5, 6 or 7
400	ISCED 4 (N/A in UK)
500	ISCED 5
600	ISCED 6
700	ISCED 7
800	ISCED 8
999	Not applicable (age < 15)

HATLEVEL (EHATLEV15) Educational attainment level (ISCED11)
Cols 197/199

Start date: 2016 Q1

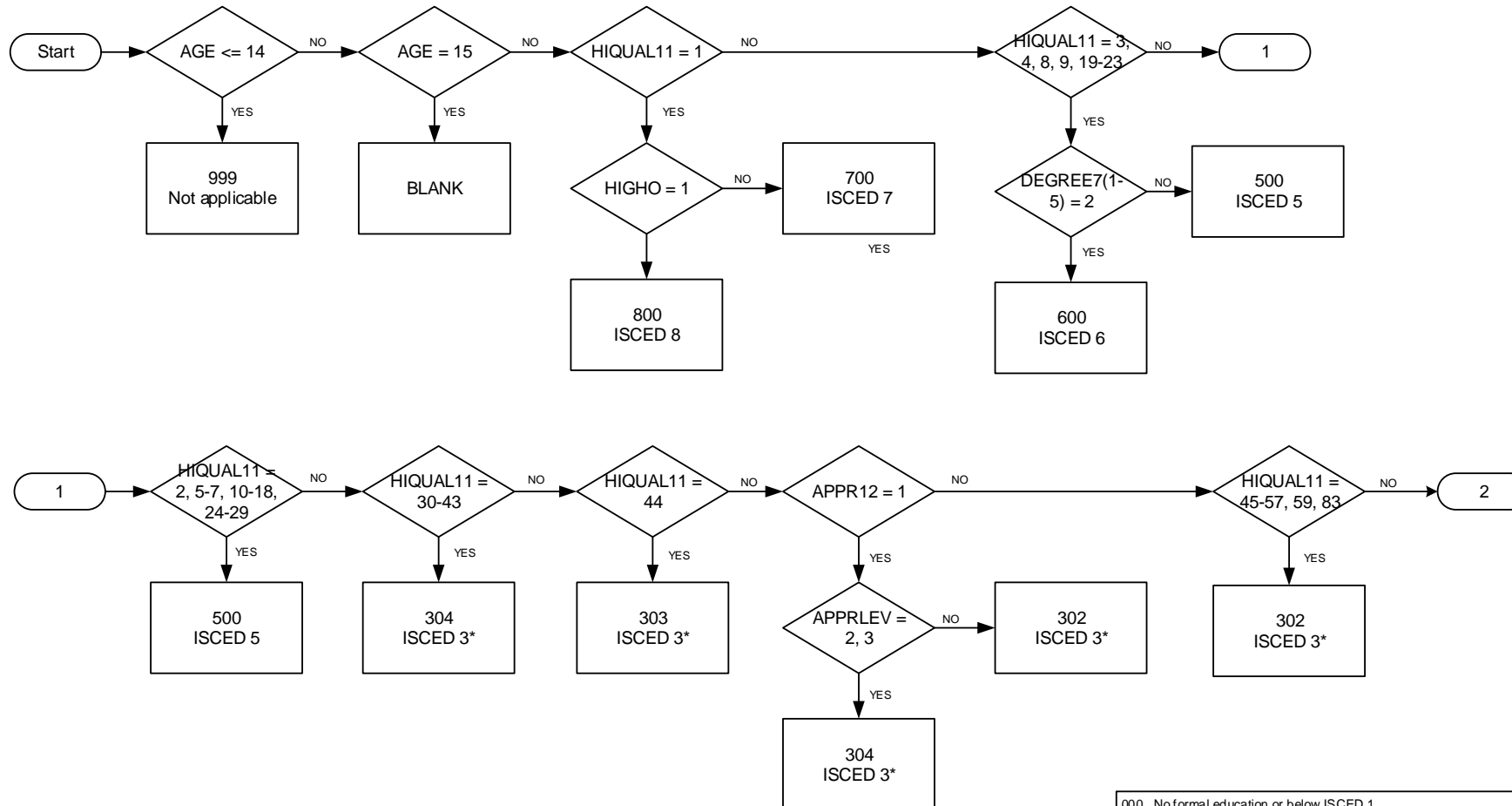

000	No formal education or below ISCED 1
100	ISCED 1
200	ISCED 2 (inc ISCED 3 programmes of duration less than 2 years)
302	ISCED 3 programme duration >= 2 years, sequential (i.e. access to next ISCED 3 programme only)
303	ISCED 3 programme duration >= 2 years, terminal or access to next ISCED 4 only (N/A in UK)
304	ISCED 3 with access to ISCED 5, 6 or 7
400	ISCED 4 (N/A in UK)
500	ISCED 5
600	ISCED 6
700	ISCED 7
800	ISCED 8
999	Not applicable (age < 15)

To 2013 Q4 see HATLEVEL (EHATLEV) cols 137-138
From 2015 Q1 to Q4 see HATLEVEL (EHATLEV15) cols 197-199
From 2016 Q1 see HATLEVEL (EHATLEV16) cols 197-199

HATLEVEL (EHATLEV15) Educational attainment level (ISCED11)
 Cols 197/199

Start date: 2016 Q1

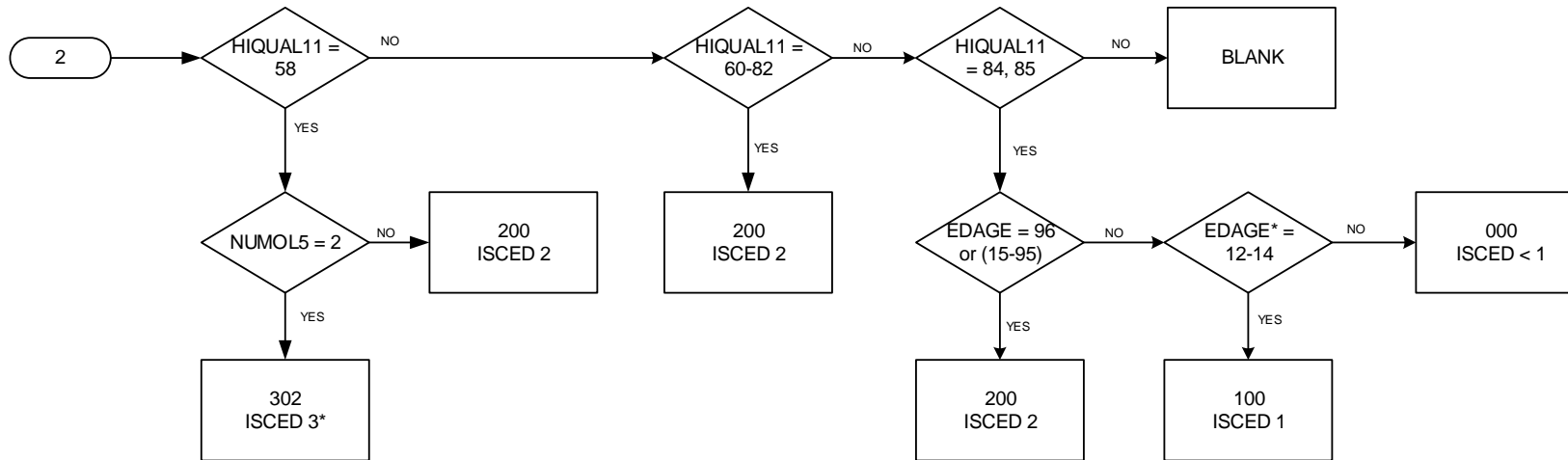

Note regarding EDAGE – Age when completed continuous full-time education.
 0 to 95 = age
 96 = still in education
 97 = never had education

000	No formal education or below ISCED 1
100	ISCED 1
200	ISCED 2 (inc ISCED 3 programmes of duration less than 2 years)
302	ISCED 3 programme duration >= 2 years, sequential (i.e. access to next ISCED 3 programme only)
303	ISCED 3 programme duration >= 2 years, terminal or access to next ISCED 4 only (N/A in UK)
304	ISCED 3 with access to ISCED 5, 6 or 7
400	ISCED 4 (N/A in UK)
500	ISCED 5
600	ISCED 6
700	ISCED 7
800	ISCED 8
999	Not applicable (age < 15)

HATYEAR (EHATYR14): Year when highest level of education or training successfully completed
Columns 200/203

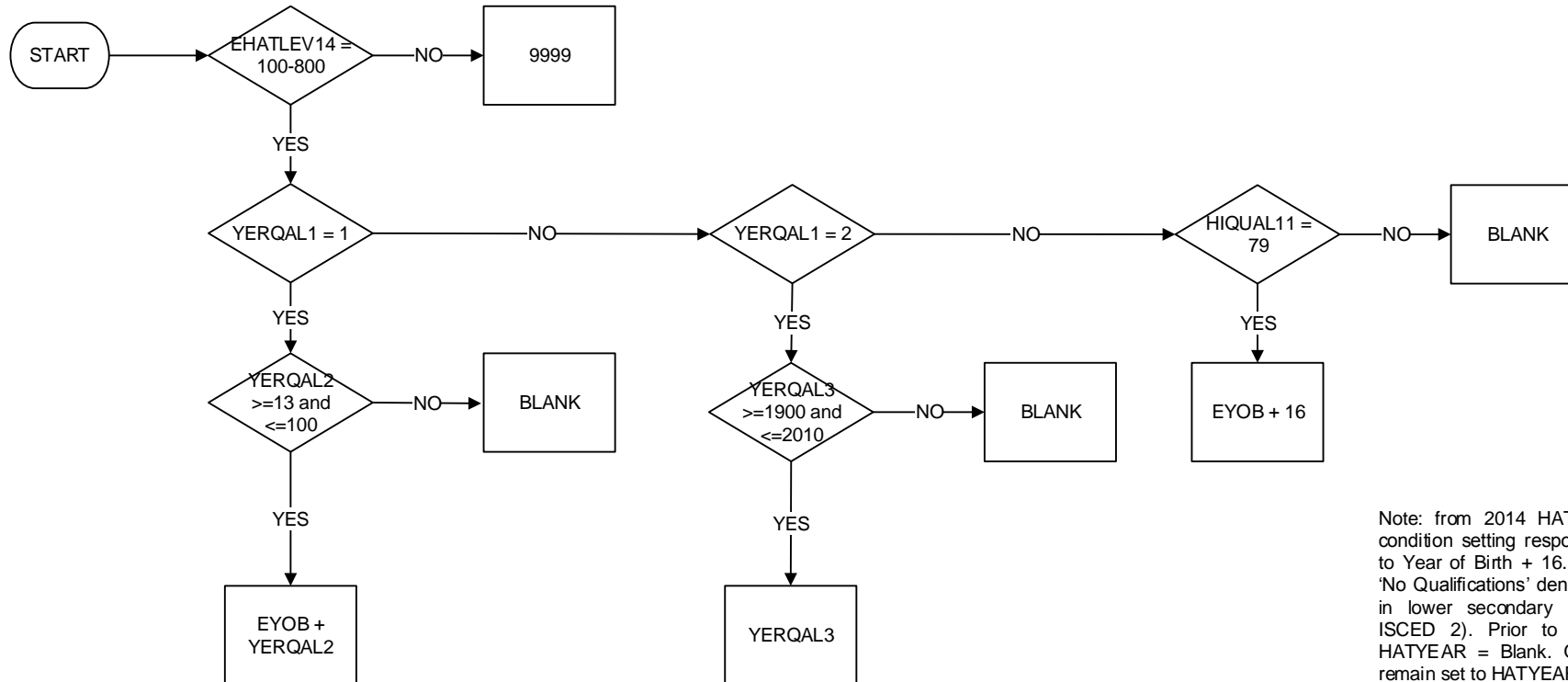

Note: from 2014 HATYEAR includes an additional condition setting respondents with 'No Qualifications' to Year of Birth + 16. Eurostat codification assumes 'No Qualifications' denotes completion of/participation in lower secondary education (i.e. HATLEVEL = ISCED 2). Prior to 2014 such cases were set HATYEAR = Blank. Qualifications gained overseas remain set to HATYEAR = Blank.

KEY	
The 4 digits of year when highest level of education or training was successfully completed are entered	
9999	Not applicable (HATLEVEL = 11-60)
BLANK	No answer

HATYEAR (EHATYR15) : Year when highest level of education or training successfully completed
 Columns 200/203

Start date: 2015 Q1

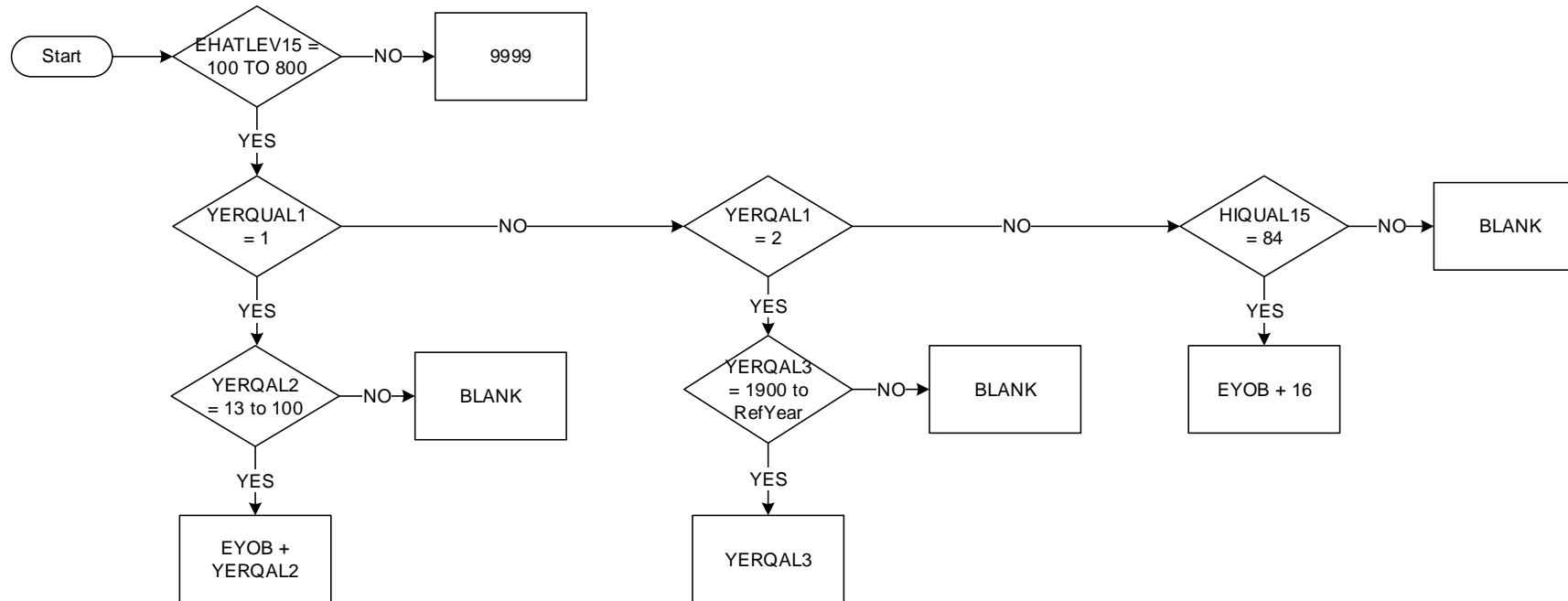

HATVOC (EHATVOC14): Orientation of programme completed at the highest education level (i.e. HATLEVEL)
 Column 204

Start date: 2014 Q1

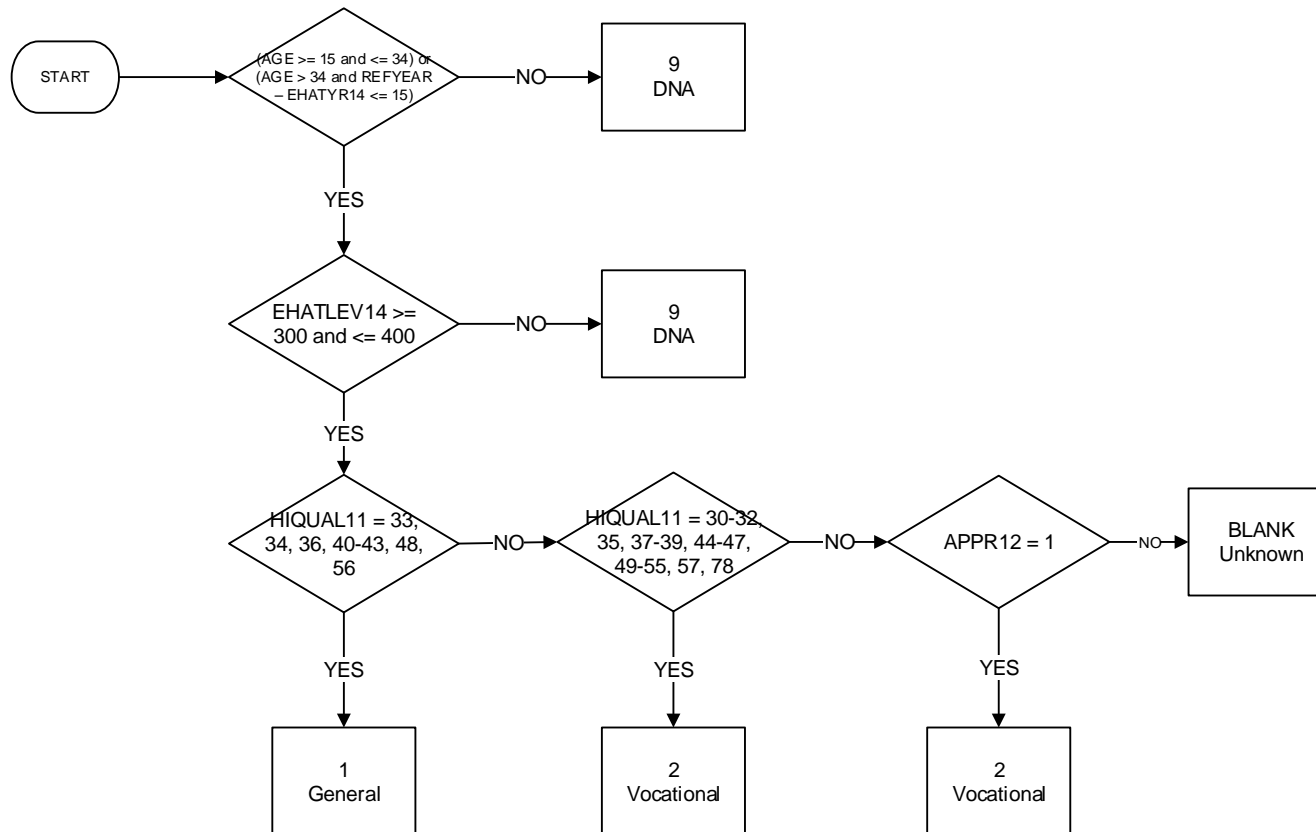

KEY

- 1 General
- 2 Vocational
- 9 Not applicable (HATLEVEL ≠ 300 to 400 or (AGE > 34 and REFYEAR – HATYEAR > 15))

For full details see *EU LFS explanatory notes from 2014*, pp 128-129.

HATVOC (EHATVOC15): Orientation of programme completed at the highest education level (i.e. HATLEVEL)
 Column 204

Start date: 2015 Q1

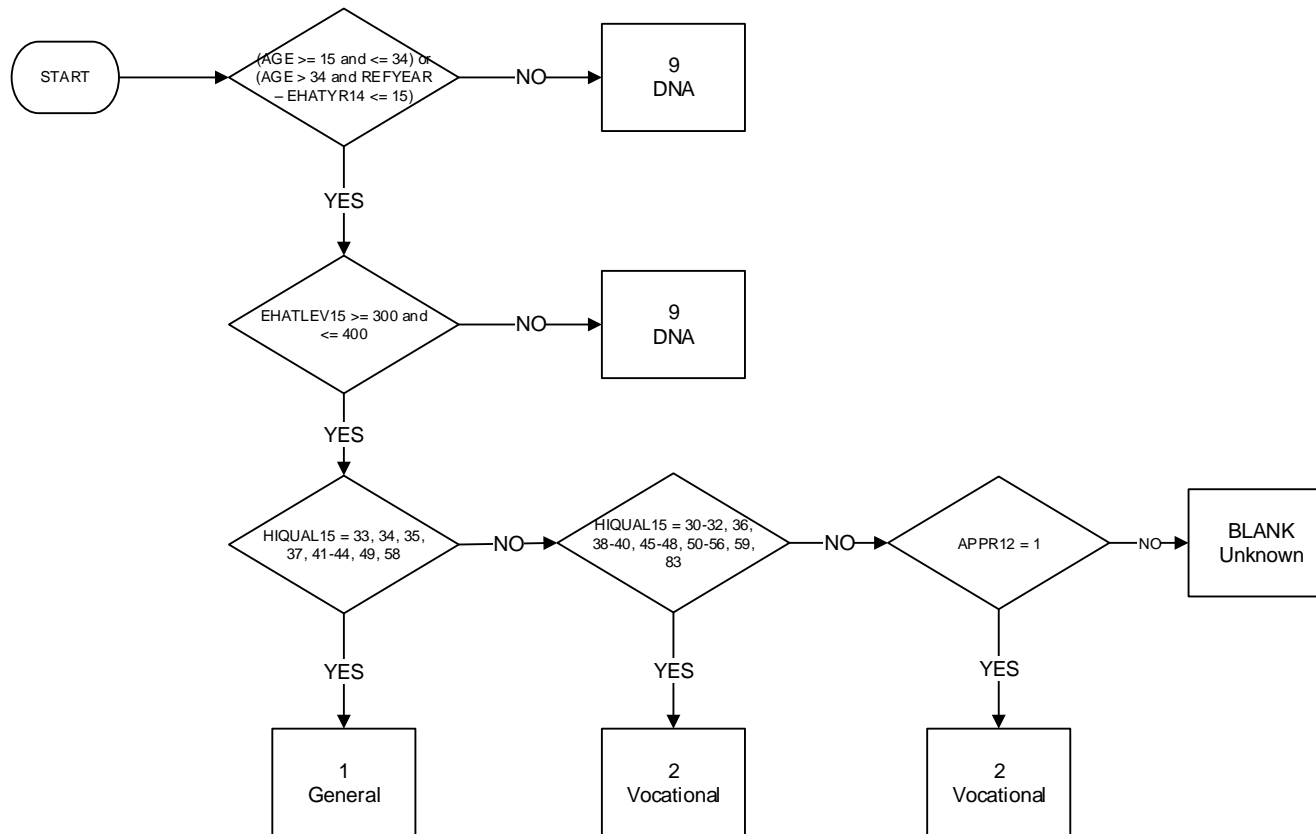

KEY

- 1 General
- 2 Vocational
- 9 Not applicable (HATLEVEL ≠ 300 to 400 or (AGE > 34 and REFYEAR – HATYEAR > 15))

For full details see *EU LFS explanatory notes from 2014*, pp 128-129.

HATFIELD (EHATFLD14): Field of highest level of education or training successfully completed
Columns 205/208

Start date: 2014 Q1
End date: 2014 Q4

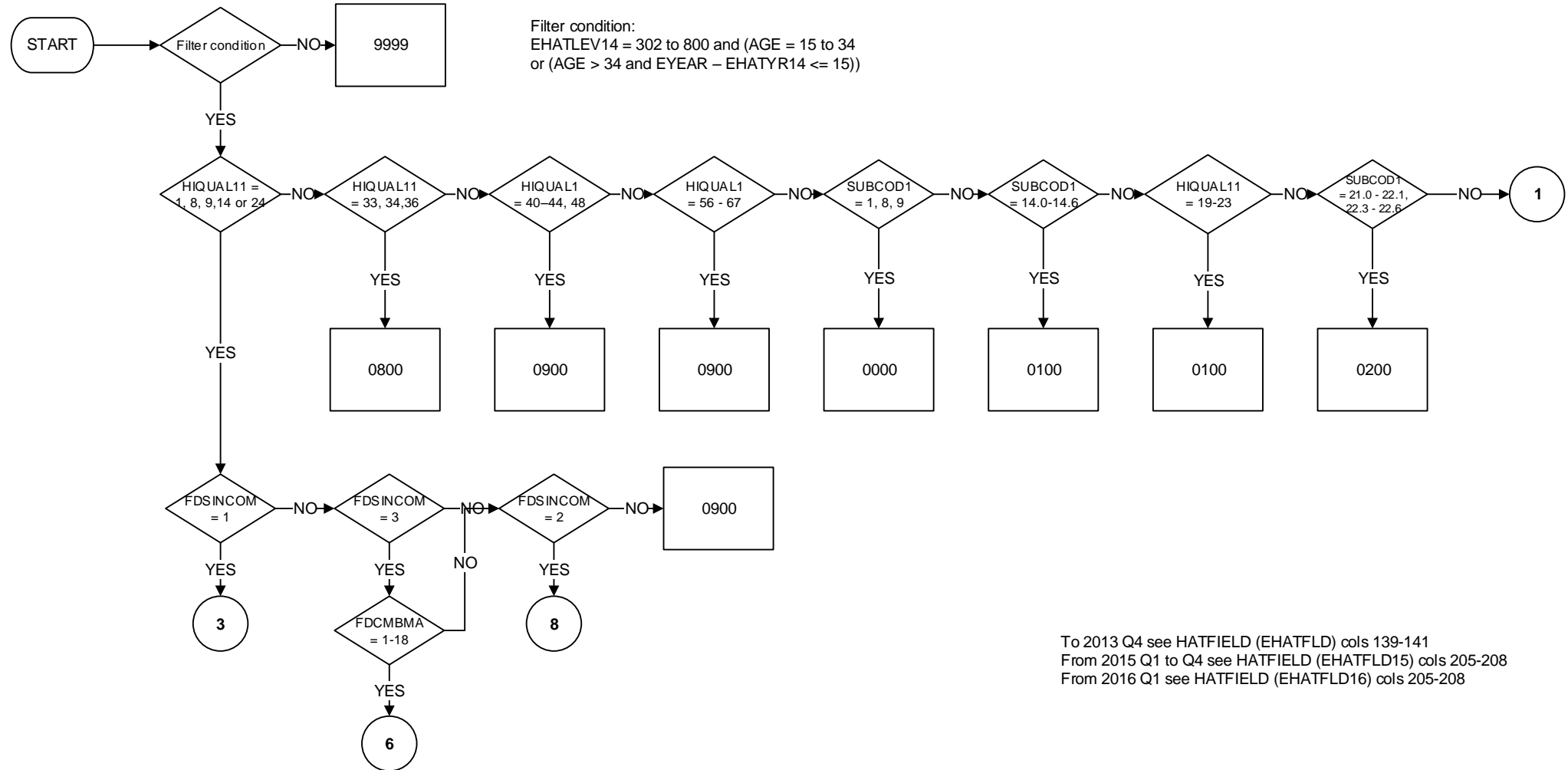

HATFIELD (EHATFLD14): Field of highest level of education or training successfully completed
Columns 205/208

Start date: 2014 Q1
End date: 2014 Q4

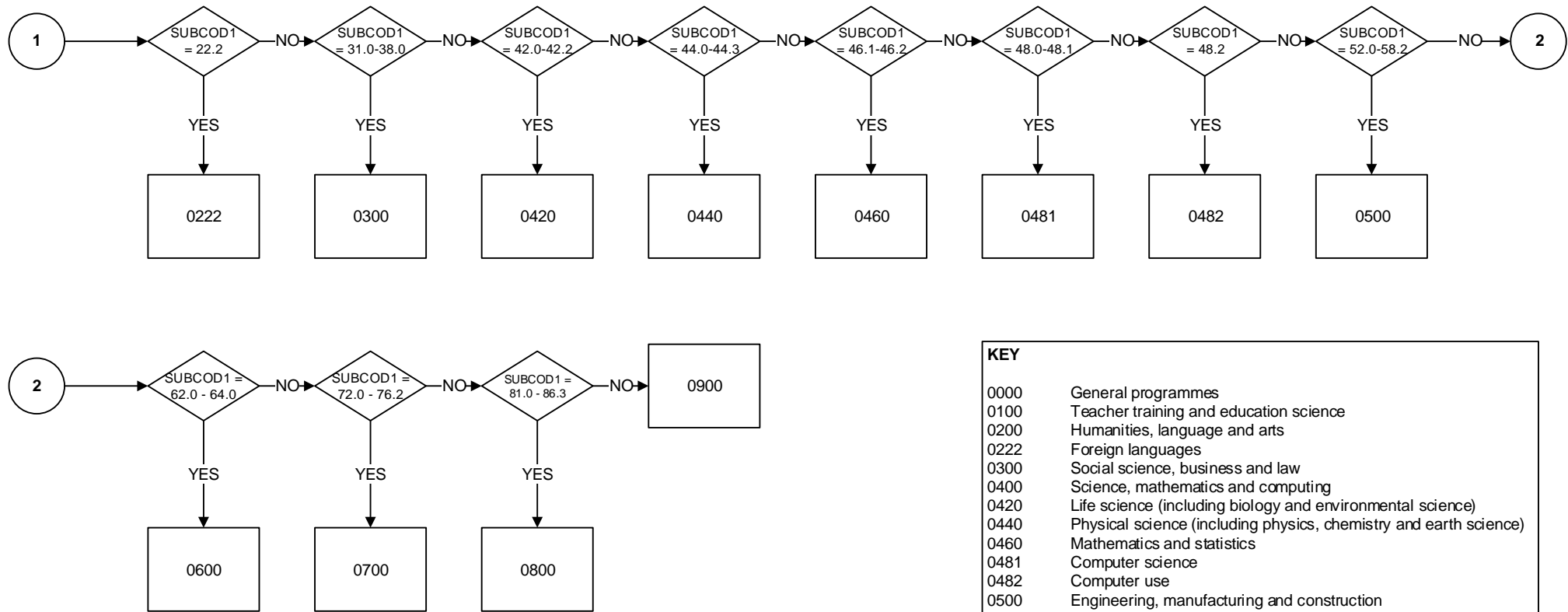

KEY

- 0000 General programmes
- 0100 Teacher training and education science
- 0200 Humanities, language and arts
- 0222 Foreign languages
- 0300 Social science, business and law
- 0400 Science, mathematics and computing
- 0420 Life science (including biology and environmental science)
- 0440 Physical science (including physics, chemistry and earth science)
- 0460 Mathematics and statistics
- 0481 Computer science
- 0482 Computer use
- 0500 Engineering, manufacturing and construction
- 0600 Agriculture and veterinary
- 0700 Health and welfare
- 0800 Services
- 0900 unknown
- 9999 Not applicable ECHATLEV14 = 302 to 800 and (AGE = 15 to 34 or (AGE > 34 and EYEAR - EHATYR14 <= 15))

BLANK No answer

Notes

SUBCOD1 values output as string not numeric, see attached coding frame.

HATFIELD (EHATFLD14): Field of highest level of education or training successfully completed
Columns 205/208

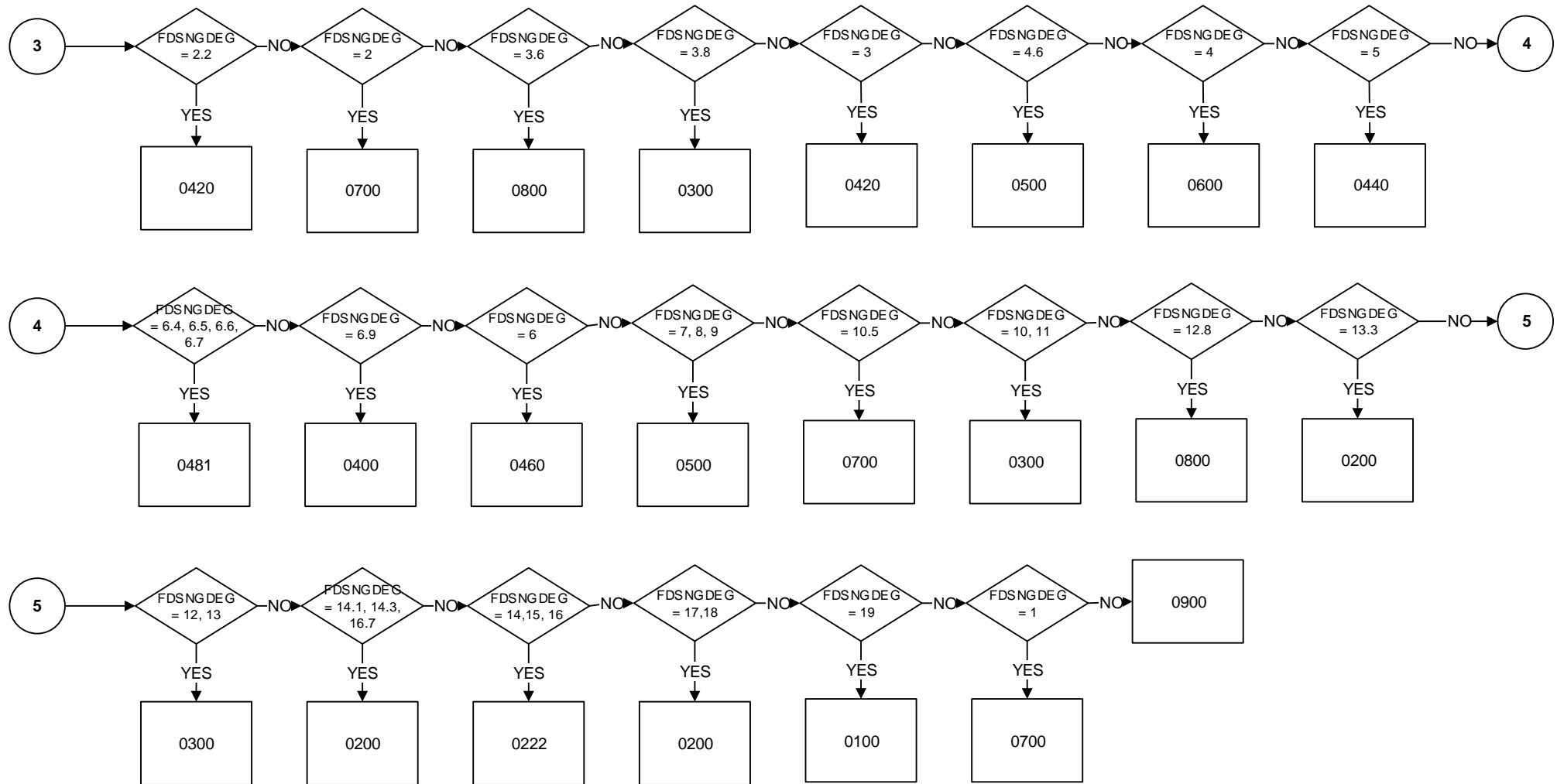

HATFIELD (EHATFLD14): Field of highest level of education or training successfully completed
Columns 205/208

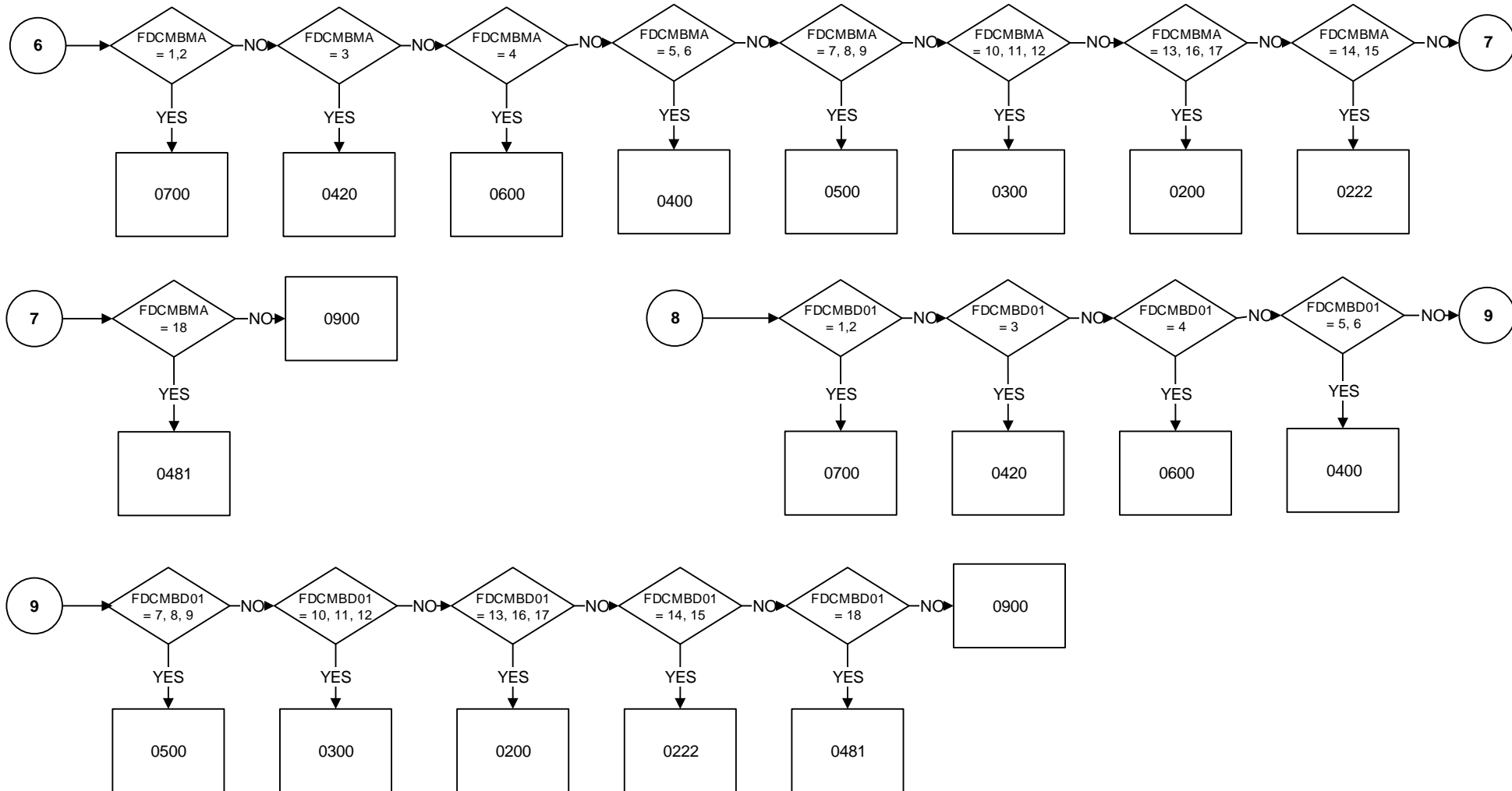

HATFIELD (EHATFLD15): Field of highest level of education or training successfully completed
Columns 205/208

Start date: 2015 Q1
End date: 2015 Q4

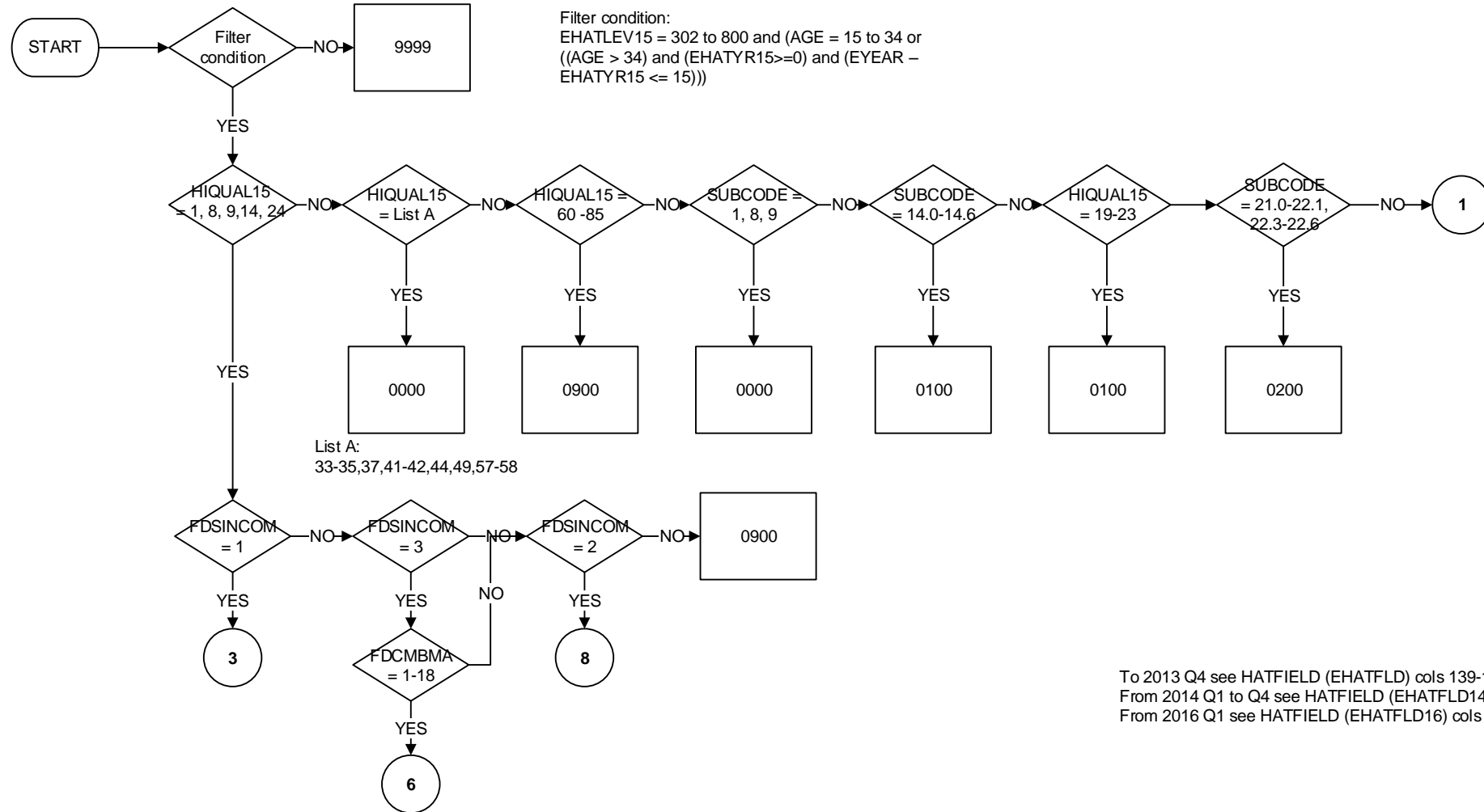

HATFIELD (EHATFLD15): Field of highest level of education or training successfully completed
Columns 205/208

Start date: 2015 Q1
End date: 2015 Q4

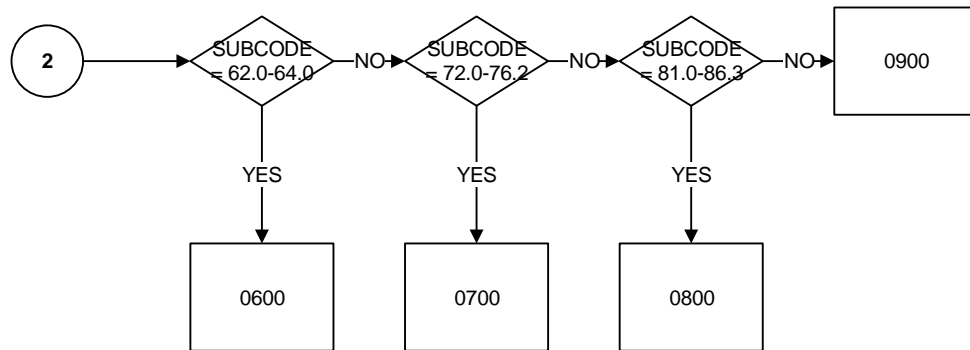
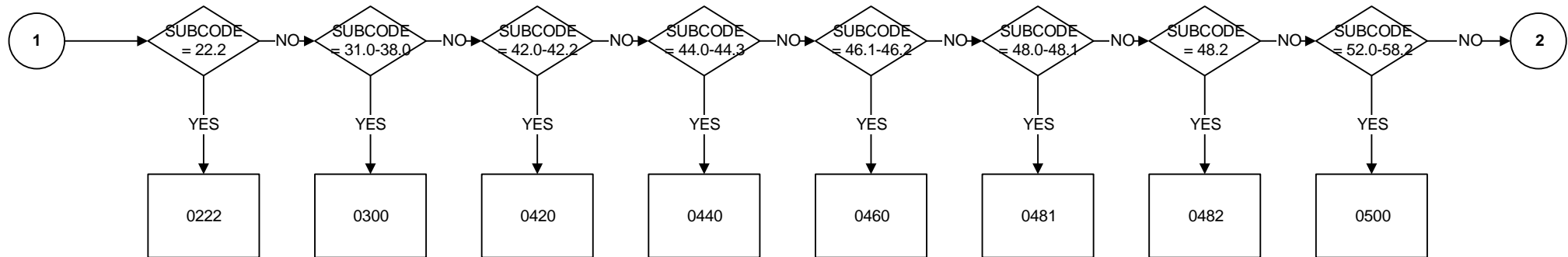

KEY

- 0000 General programmes
- 0100 Teacher training and education science
- 0200 Humanities, language and arts
- 0222 Foreign languages
- 0300 Social science, business and law
- 0400 Science, mathematics and computing
- 0420 Life science (including biology and environmental science)
- 0440 Physical science (including physics, chemistry and earth science)
- 0460 Mathematics and statistics
- 0481 Computer science
- 0482 Computer use
- 0500 Engineering, manufacturing and construction
- 0600 Agriculture and veterinary
- 0700 Health and welfare
- 0800 Services
- 0900 unknown
- 9999 Not applicable EHATLEV15 = 302 to 800 and (AGE = 15 to 34 or (AGE > 34 and EYEAR - EHATYR15 <= 15))

BLANK No answer

Notes

SUBCODE values output as string not numeric, see attached coding frame.

HATFIELD (EHATFLD15): Field of highest level of education or training successfully completed
Columns 205/208

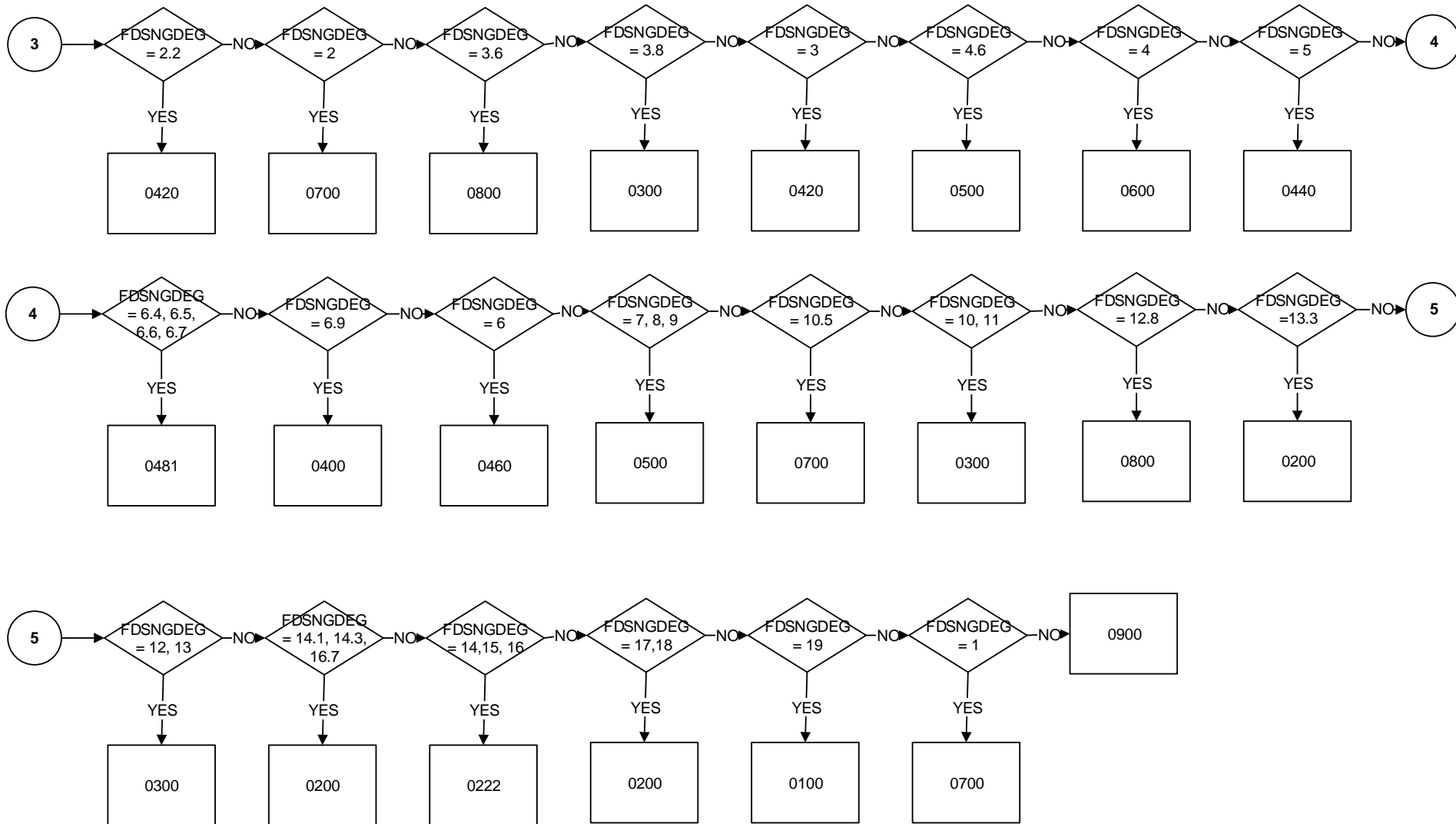

HATFIELD (EHATFLD15): Field of highest level of education or training successfully completed
Columns 205/208

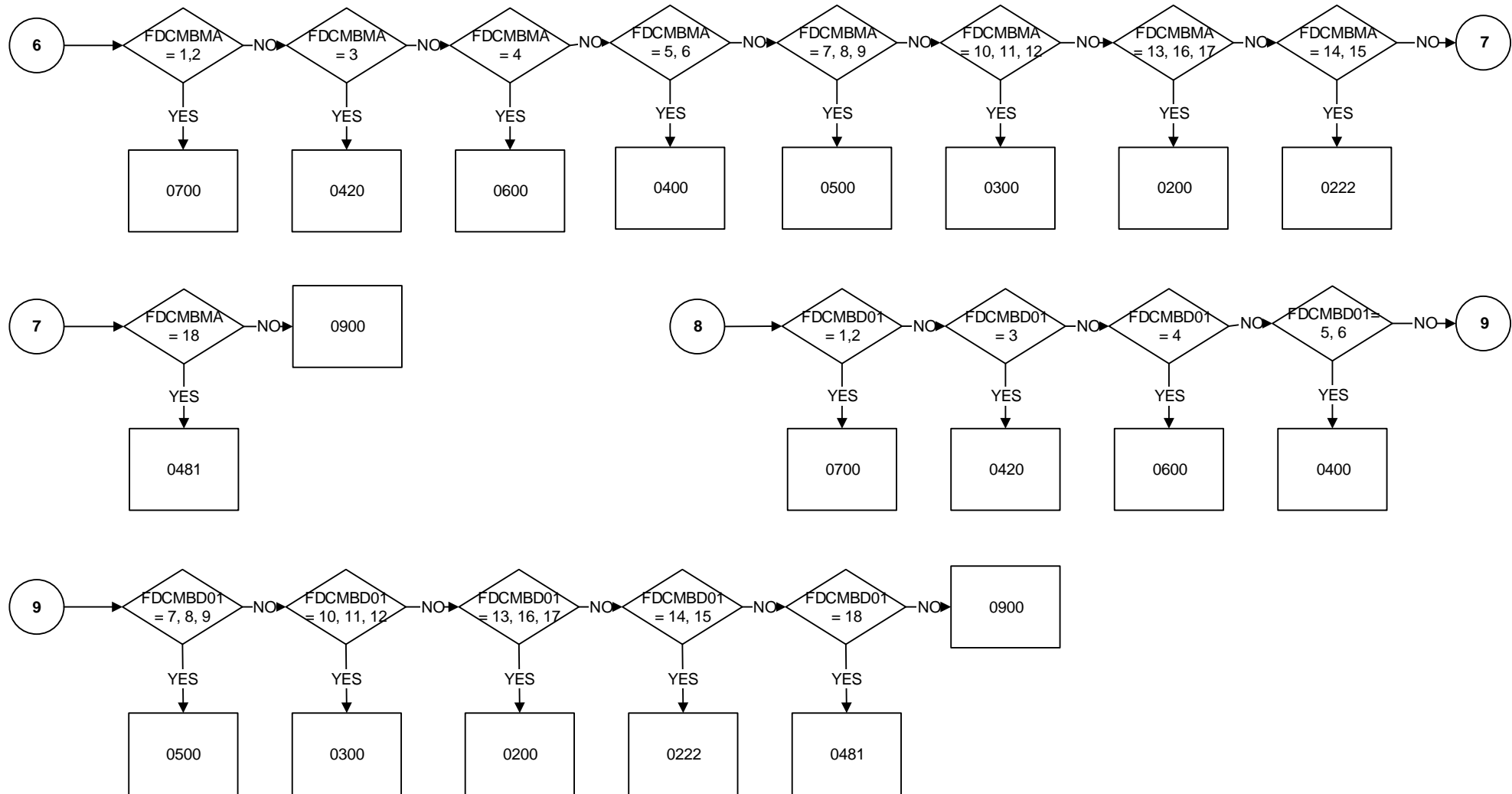

HATFIELD (EHATFLD16): Field of highest level of education or training successfully completed

Start date: 2016 Q1

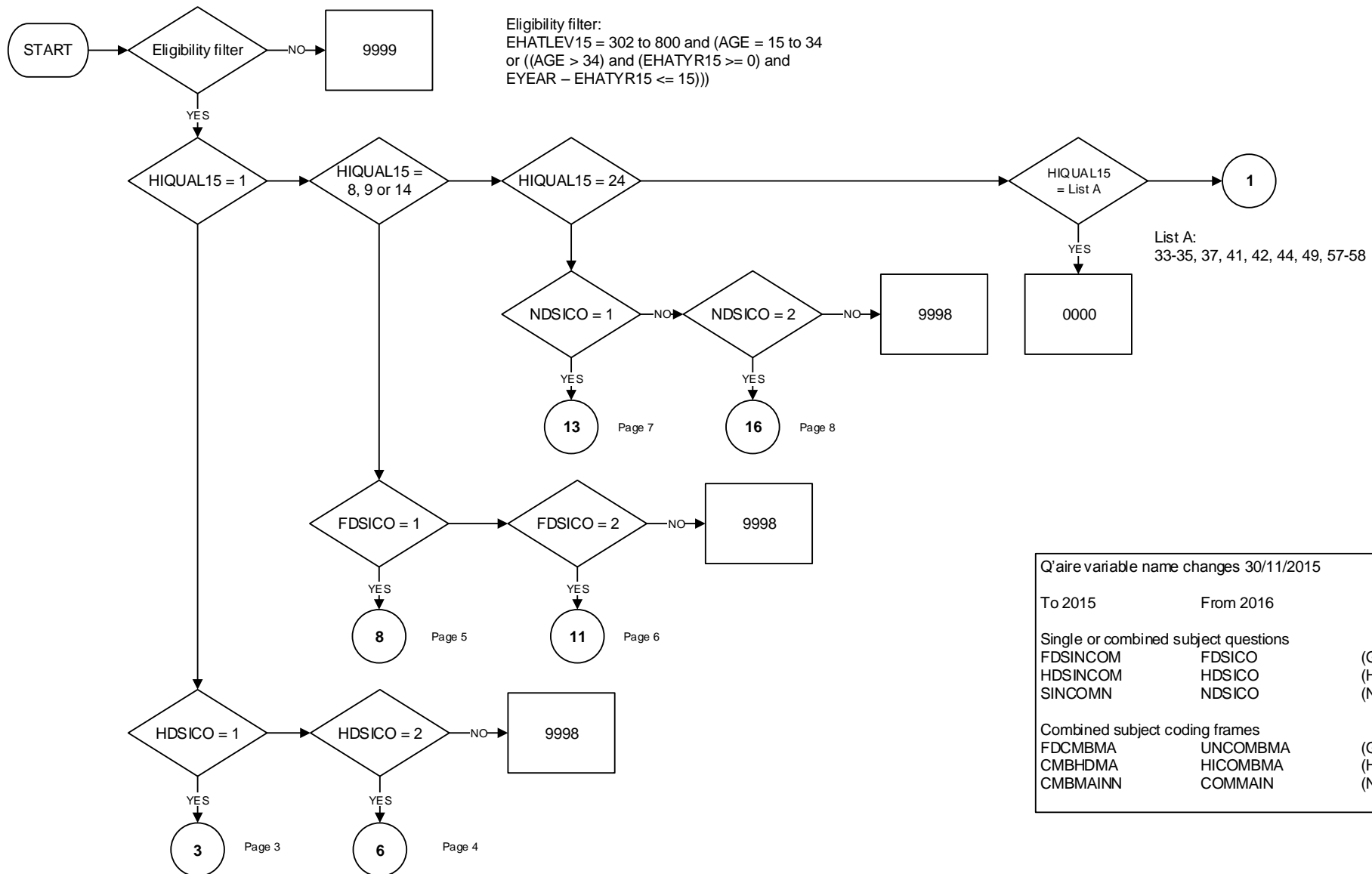

List A:
 33-35, 37, 41, 42, 44, 49, 57-58

Q'aire variable name changes 30/11/2015

To 2015	From 2016	
Single or combined subject questions		
FDSINCOM	FDSICO	(General)
HDSINCOM	HDSICO	(Higher)
SINCOMN	NDSICO	(Nursing)
Combined subject coding frames		
FDCMBMA	UNCOMBMA	(General)
CMBHDMA	HICOMBMA	(Higher)
CMBMAINN	COMMAIN	(Nursing)

HATFIELD (EHATFLD16): Field of highest level of education or training successfully completed

Start date: 2016 Q1

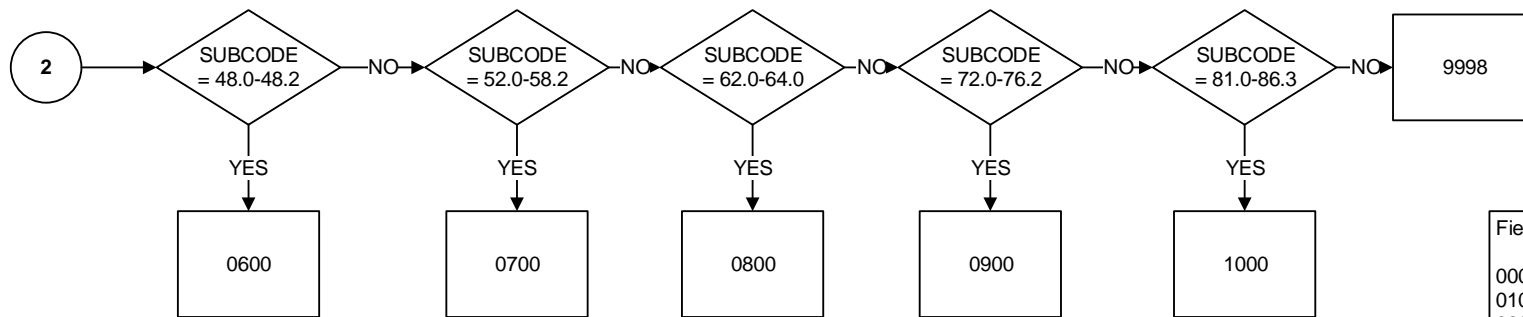
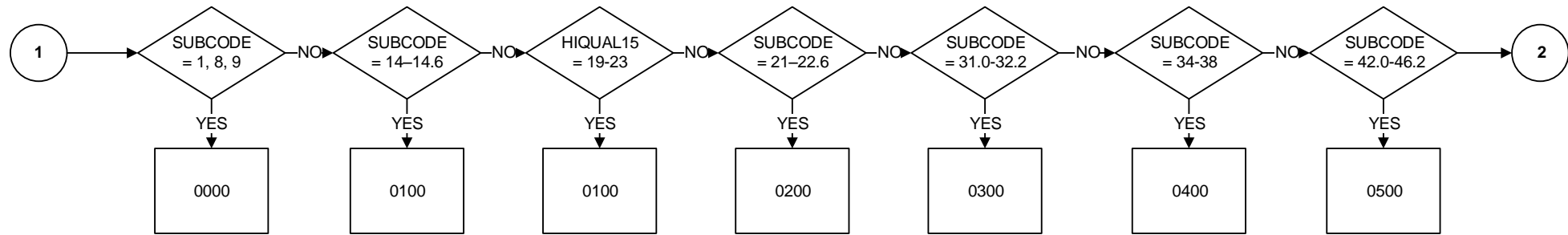

Fields of Education 2016	
0000	Generic programmes and qualifications
0100	Education
0200	Arts and humanities
0300	Social sciences, journalism and information
0400	Business, administration and law
0500	Natural sciences, mathematics and statistics
0600	Information and communication technologies
0700	Engineering, manufacturing and construction
0800	Agriculture, forestry, fisheries and veterinary
0900	Health and welfare
1000	Services
9998	Unknown or unspecified
9999	Does not apply

HATFIELD (EHATFLD16): Field of highest level of education or training successfully completed

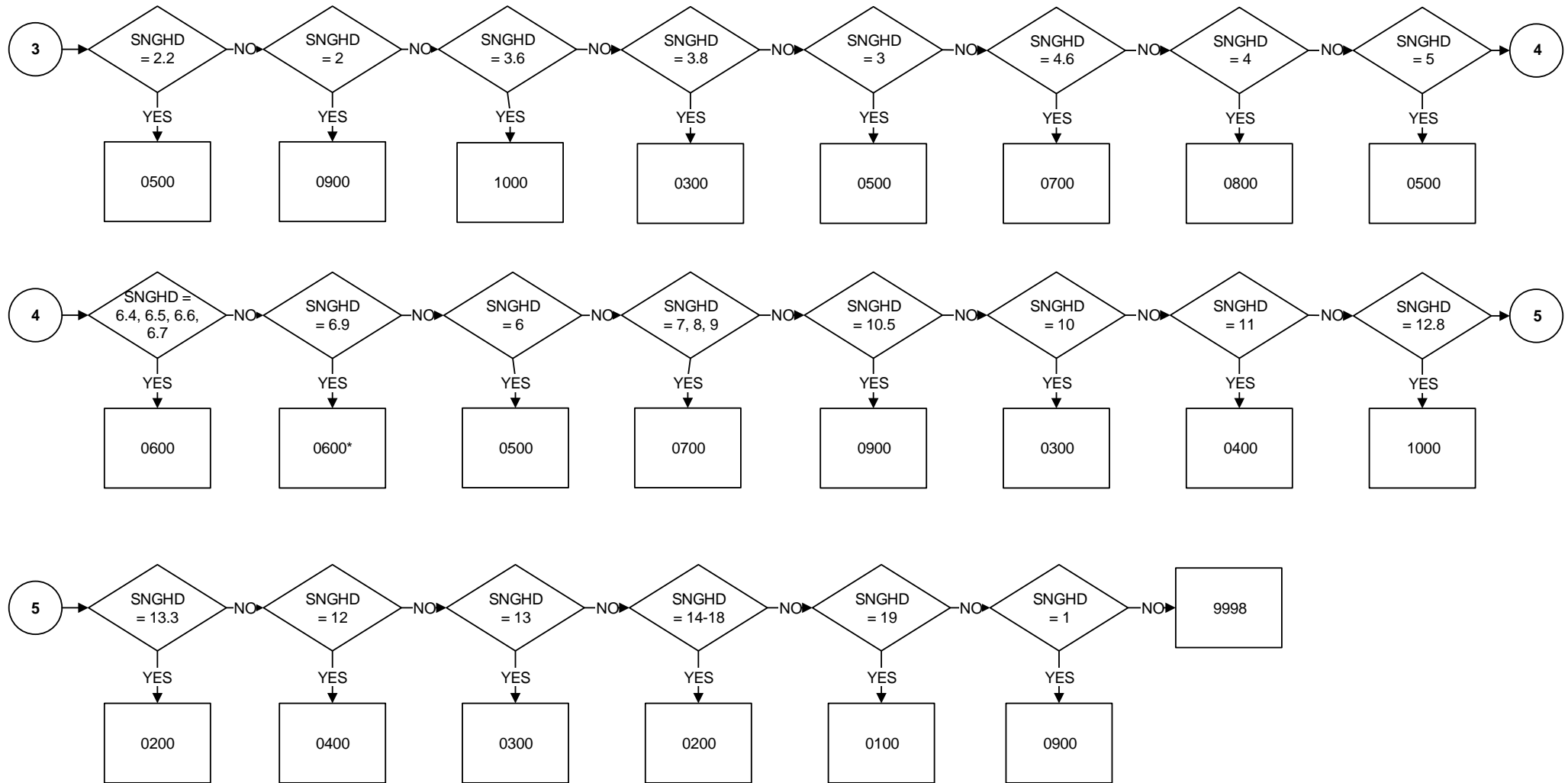

HATFIELD (EHATFLD16): Field of highest level of education or training successfully completed

Start date: 2016 Q1

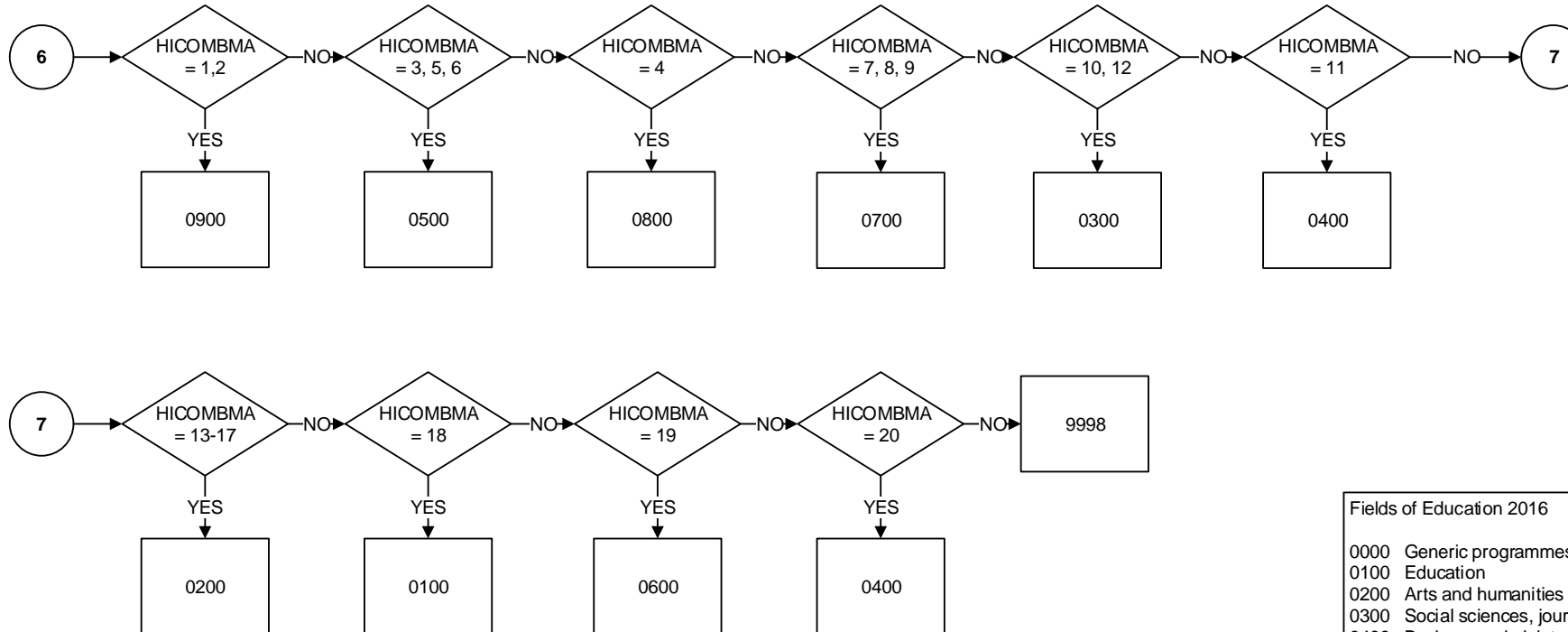

Fields of Education 2016	
0000	Generic programmes and qualifications
0100	Education
0200	Arts and humanities
0300	Social sciences, journalism and information
0400	Business, administration and law
0500	Natural sciences, mathematics and statistics
0600	Information and communication technologies
0700	Engineering, manufacturing and construction
0800	Agriculture, forestry, fisheries and veterinary
0900	Health and welfare
1000	Services
9998	Unknown or unspecified
9999	Does not apply

HATFIELD (EHATFLD16): Field of highest level of education or training successfully completed

Start date: 2016 Q1

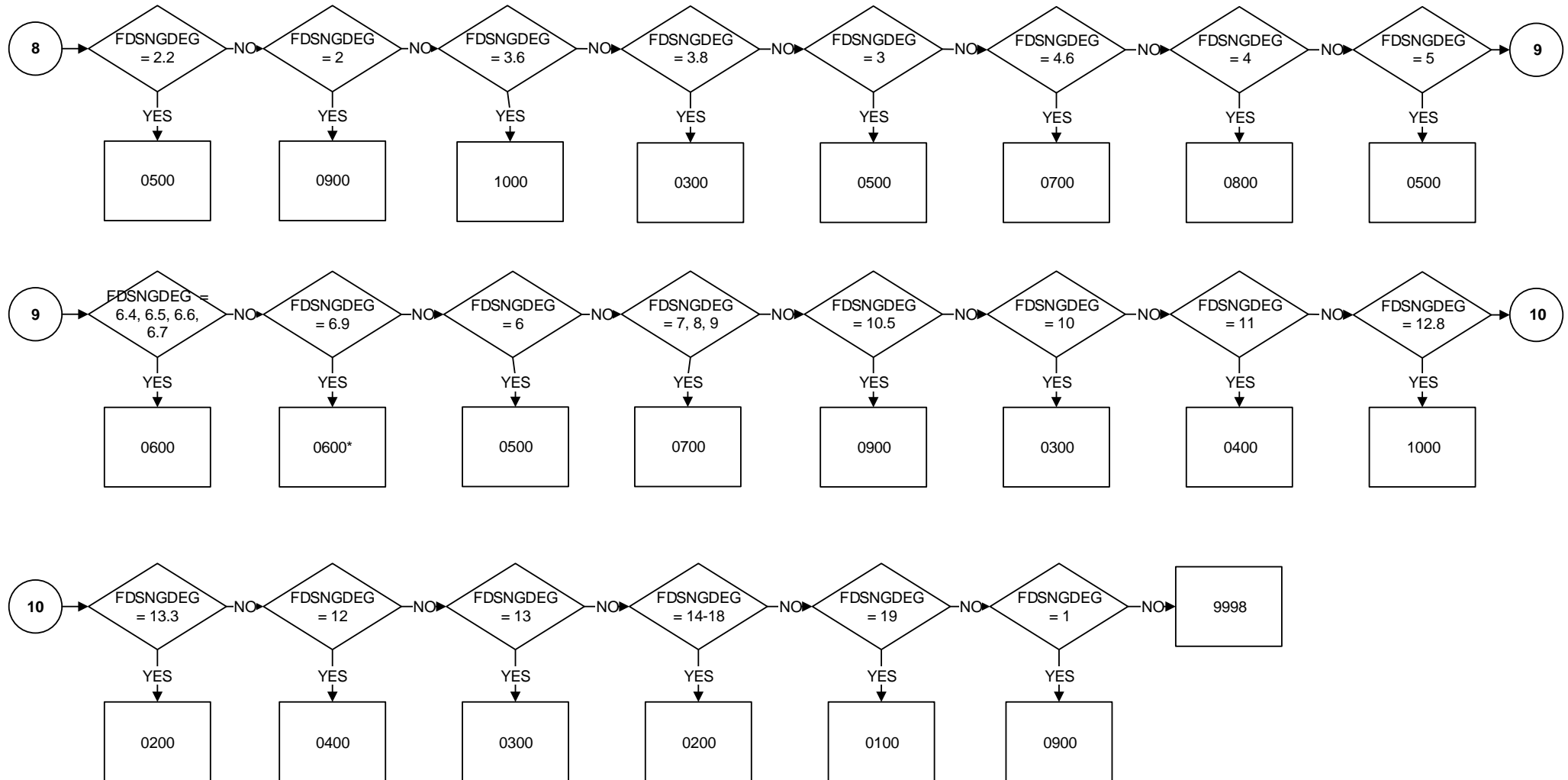

HATFIELD (EHATFLD16): Field of highest level of education or training successfully completed

Start date: 2016 Q1

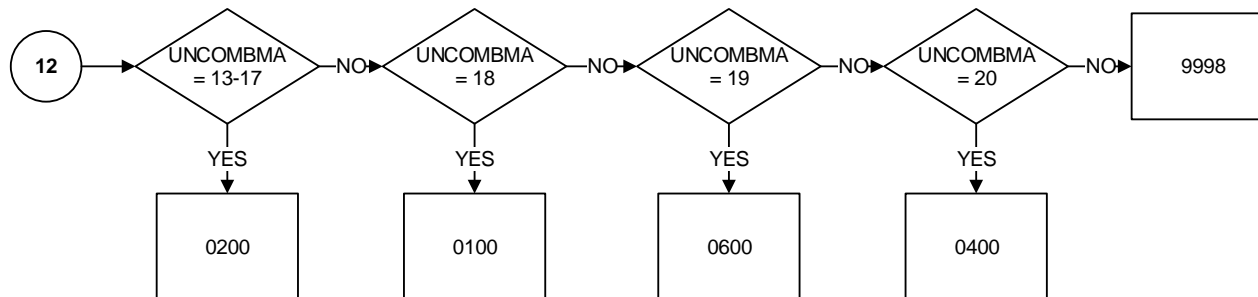
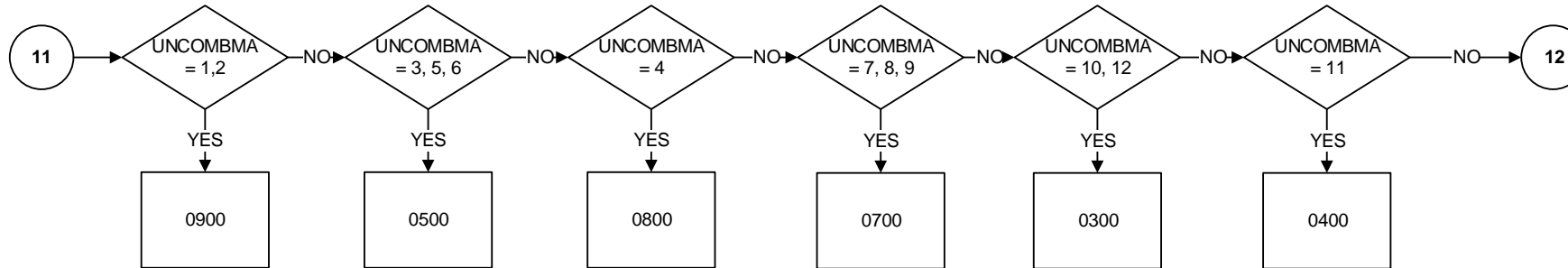

Fields of Education 2016	
0000	Generic programmes and qualifications
0100	Education
0200	Arts and humanities
0300	Social sciences, journalism and information
0400	Business, administration and law
0500	Natural sciences, mathematics and statistics
0600	Information and communication technologies
0700	Engineering, manufacturing and construction
0800	Agriculture, forestry, fisheries and veterinary
0900	Health and welfare
1000	Services
9998	Unknown or unspecified
9999	Does not apply

HATFIELD (EHATFLD16): Field of highest level of education or training successfully completed

Start date: 2016 Q1

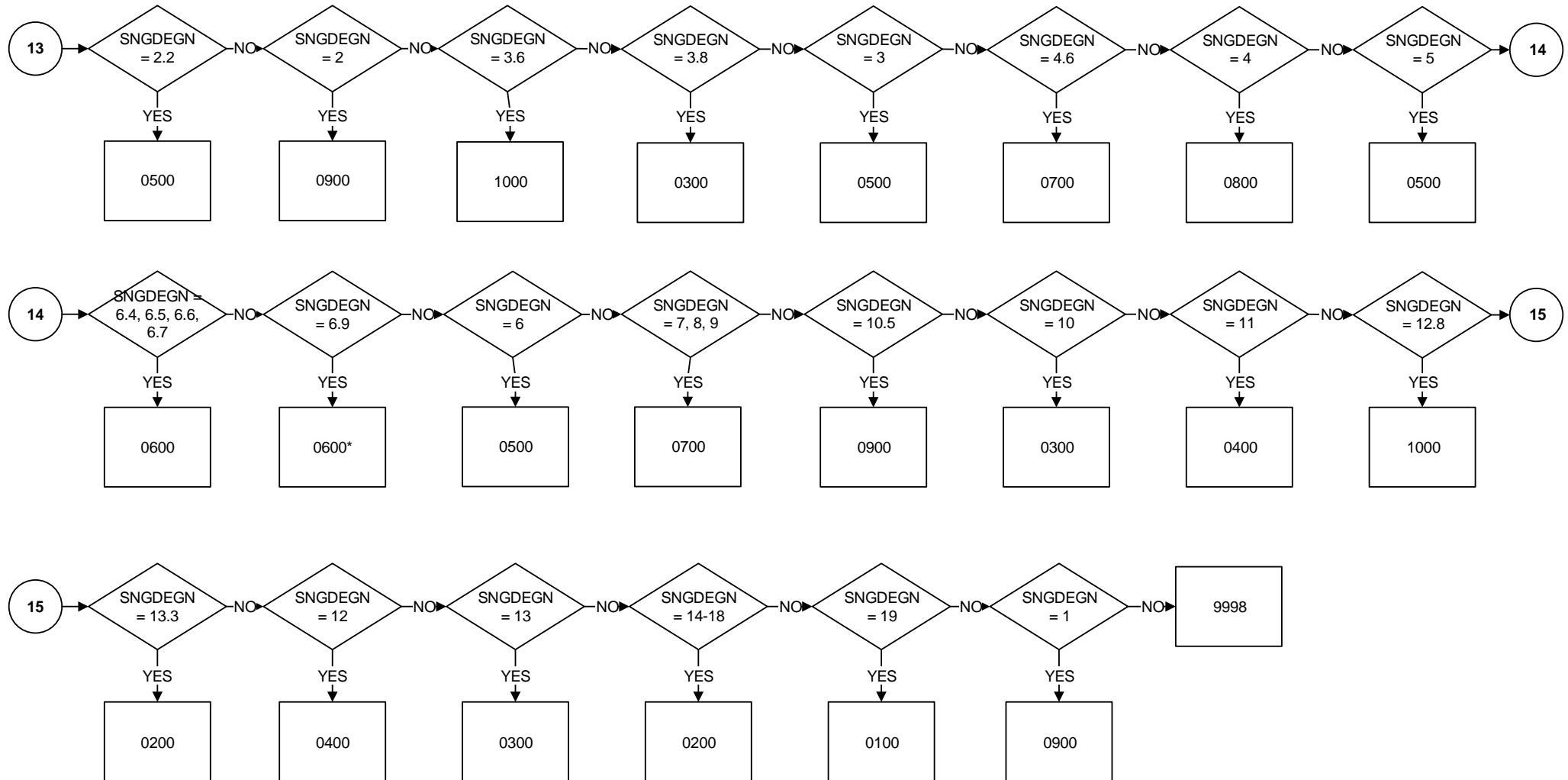

HATFIELD (EHATFLD16): Field of highest level of education or training successfully completed

Start date: 2016 Q1

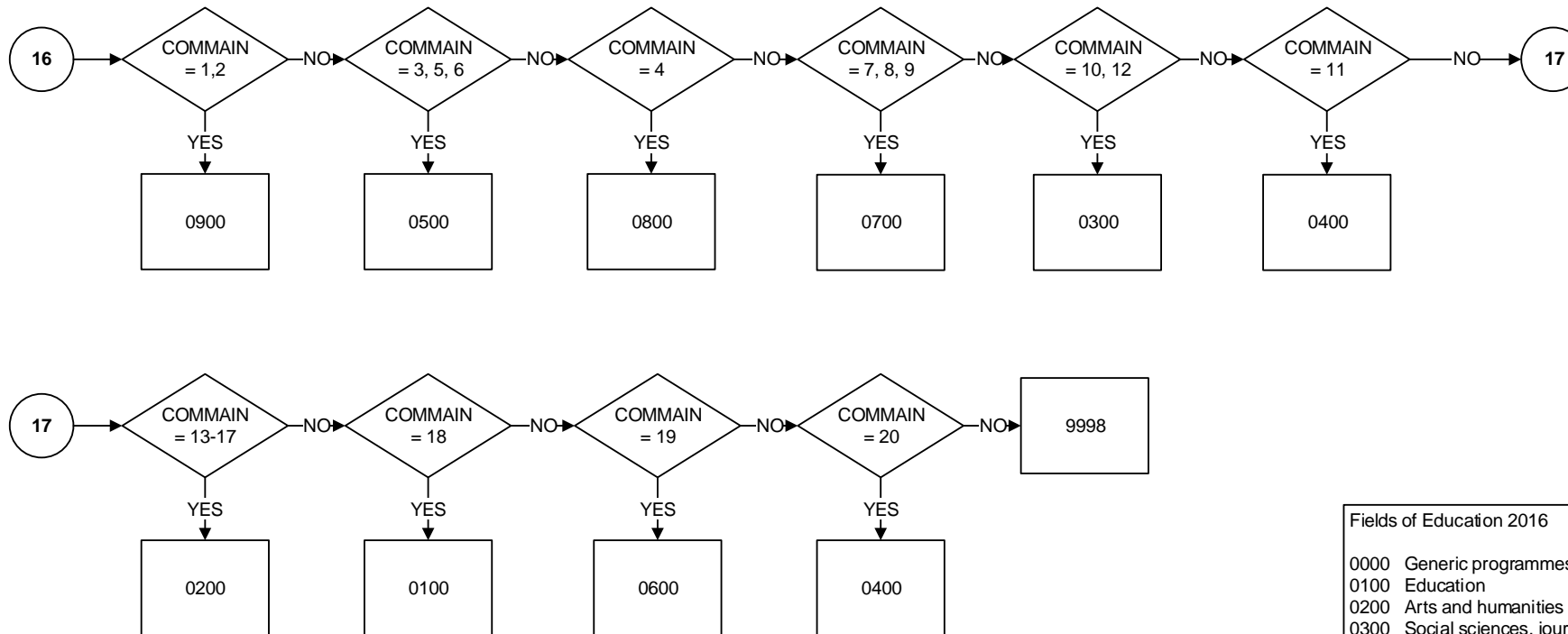

Fields of Education 2016	
0000	Generic programmes and qualifications
0100	Education
0200	Arts and humanities
0300	Social sciences, journalism and information
0400	Business, administration and law
0500	Natural sciences, mathematics and statistics
0600	Information and communication technologies
0700	Engineering, manufacturing and construction
0800	Agriculture, forestry, fisheries and veterinary
0900	Health and welfare
1000	Services
9998	Unknown or unspecified
9999	Does not apply

EDUCLEVEL (EDUCLEV14): Level of the current education or training (ISCED11)
Col 209

Start date: 2014 Q1
End Date: 2014 Q4

To 2013 Q4 see Col 124 EDUCLEVEL (EDUCLEV)
From 2015 Q1 to 2015 Q4 see Col 209 EDUCLEVEL (EDUCLEV15)
From 2016 Q1 see Col 209 EDUCLEVEL (EDUCLEV16)

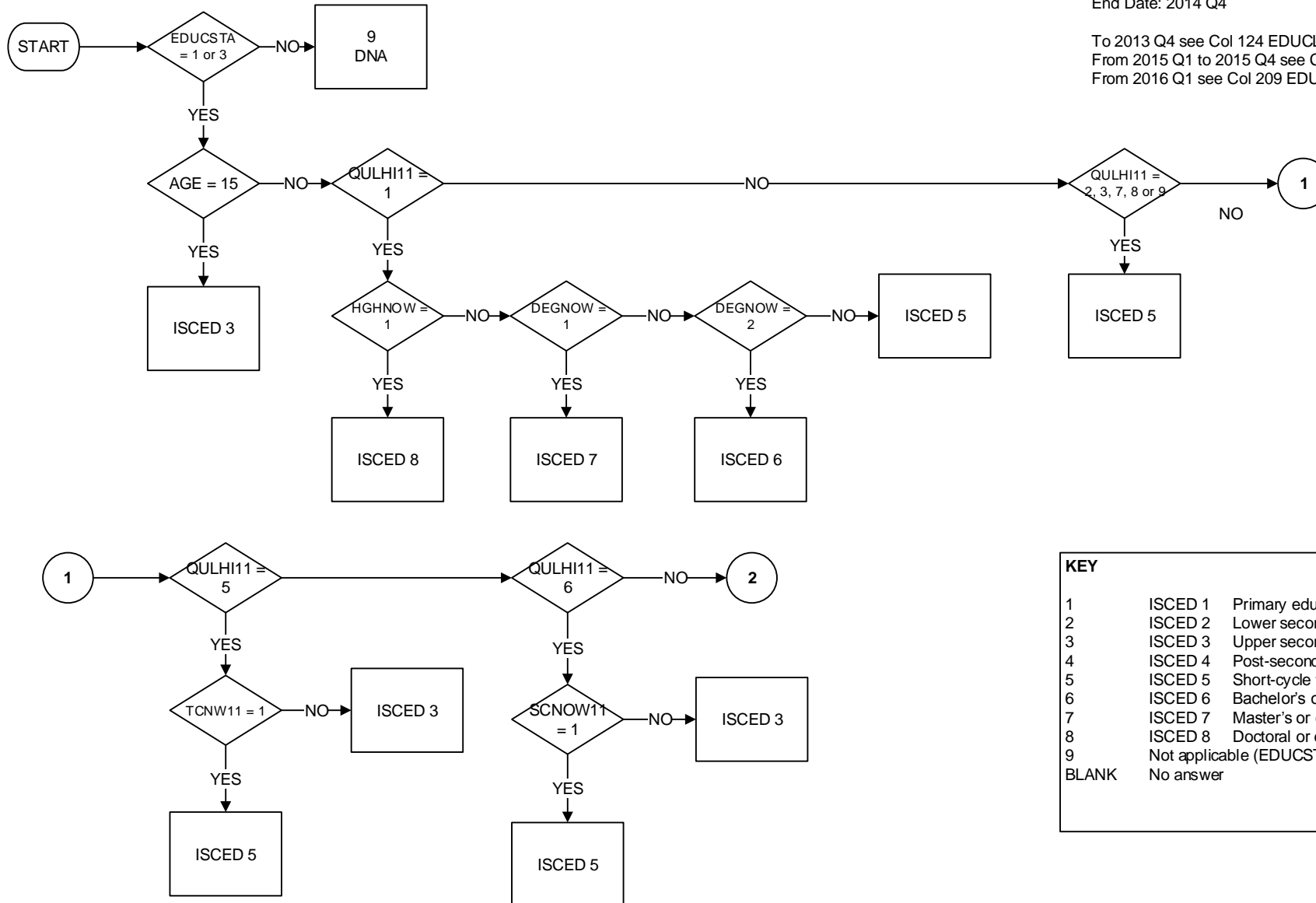

KEY		
1	ISCED 1	Primary education
2	ISCED 2	Lower secondary education
3	ISCED 3	Upper secondary education
4	ISCED 4	Post-secondary non-tertiary education (N/A in UK)
5	ISCED 5	Short-cycle tertiary education
6	ISCED 6	Bachelor's or equivalent level
7	ISCED 7	Master's or equivalent level
8	ISCED 8	Doctoral or equivalent level
9	Not applicable (EDUCSTAT = 2, 9 or BLANK)	
BLANK	No answer	

EDUCLEVEL (EDUCLEV14): Level of the current education or training (ISCED11)
Col 209

Start date: 2014 Q1
End Date: 2014 Q4

To 2013 Q4 see Col 124 EDUCLEVEL (EDUCLEV)
From 2015 Q1 to 2015 Q4 see Col 209 EDUCLEVEL (EDUCLEV15)
From 2016 Q1 see Col 209 EDUCLEVEL (EDUCLEV16)

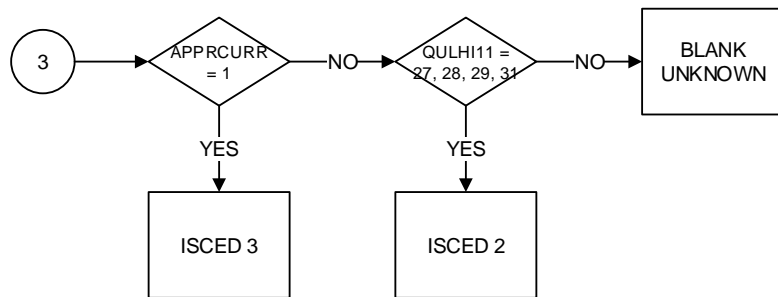
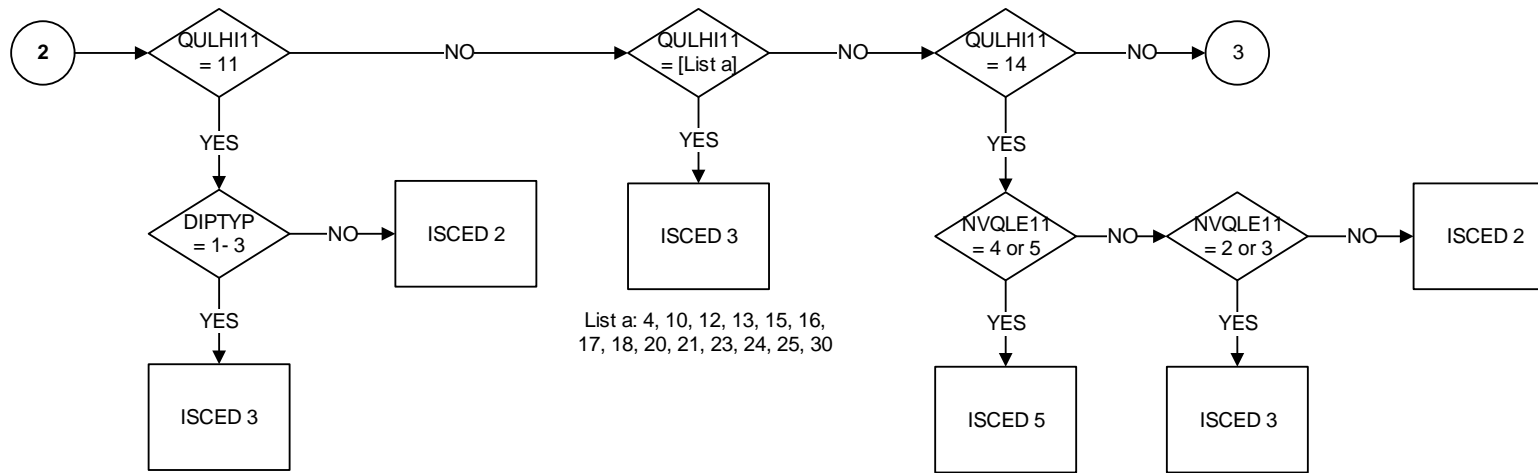

KEY		
1	ISCED 1	Primary education
2	ISCED 2	Lower secondary education
3	ISCED 3	Upper secondary education
4	ISCED 4	Post-secondary non-tertiary education (N/A in UK)
5	ISCED 5	Short-cycle tertiary education
6	ISCED 6	Bachelor's or equivalent level
7	ISCED 7	Master's or equivalent level
8	ISCED 8	Doctoral or equivalent level
9	Not applicable (EDUCSTAT = 2, 9 or BLANK)	
BLANK	No answer	

EDUCLEVEL (EDUCLEV15): Level of the current education or training (ISCED11)
Col 209

Start date: 2015 Q1
End Date: 2015 Q4

To 2013 Q4 see Col 124 EDUCLEVEL (EDUCLEV)
From 2014 Q1 to 2014 Q4 see Col 209 EDUCLEVEL (EDUCLEV14)
From 2016 Q1 see Col 209 EDUCLEVEL (EDUCLEV16)

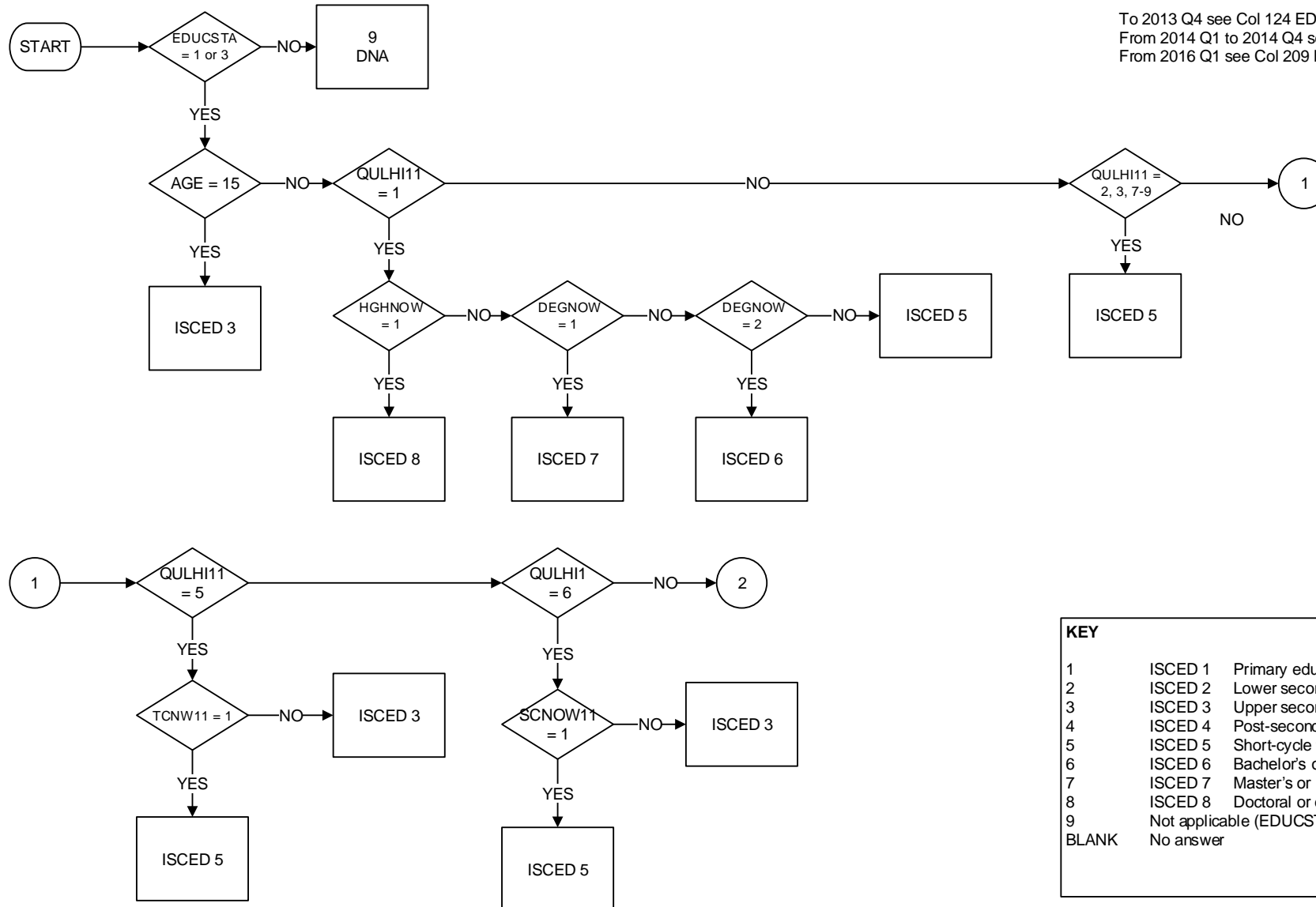

KEY		
1	ISCED 1	Primary education
2	ISCED 2	Lower secondary education
3	ISCED 3	Upper secondary education
4	ISCED 4	Post-secondary non-tertiary education (N/A in UK)
5	ISCED 5	Short-cycle tertiary education
6	ISCED 6	Bachelor's or equivalent level
7	ISCED 7	Master's or equivalent level
8	ISCED 8	Doctoral or equivalent level
9	Not applicable (EDUCSTAT = 2, 9 or BLANK)	
BLANK	No answer	

EDUCLEVEL (EDUCLEV15): Level of the current education or training (ISCED11)
Col 209

Start date: 2015 Q1
End Date: 2015 Q4

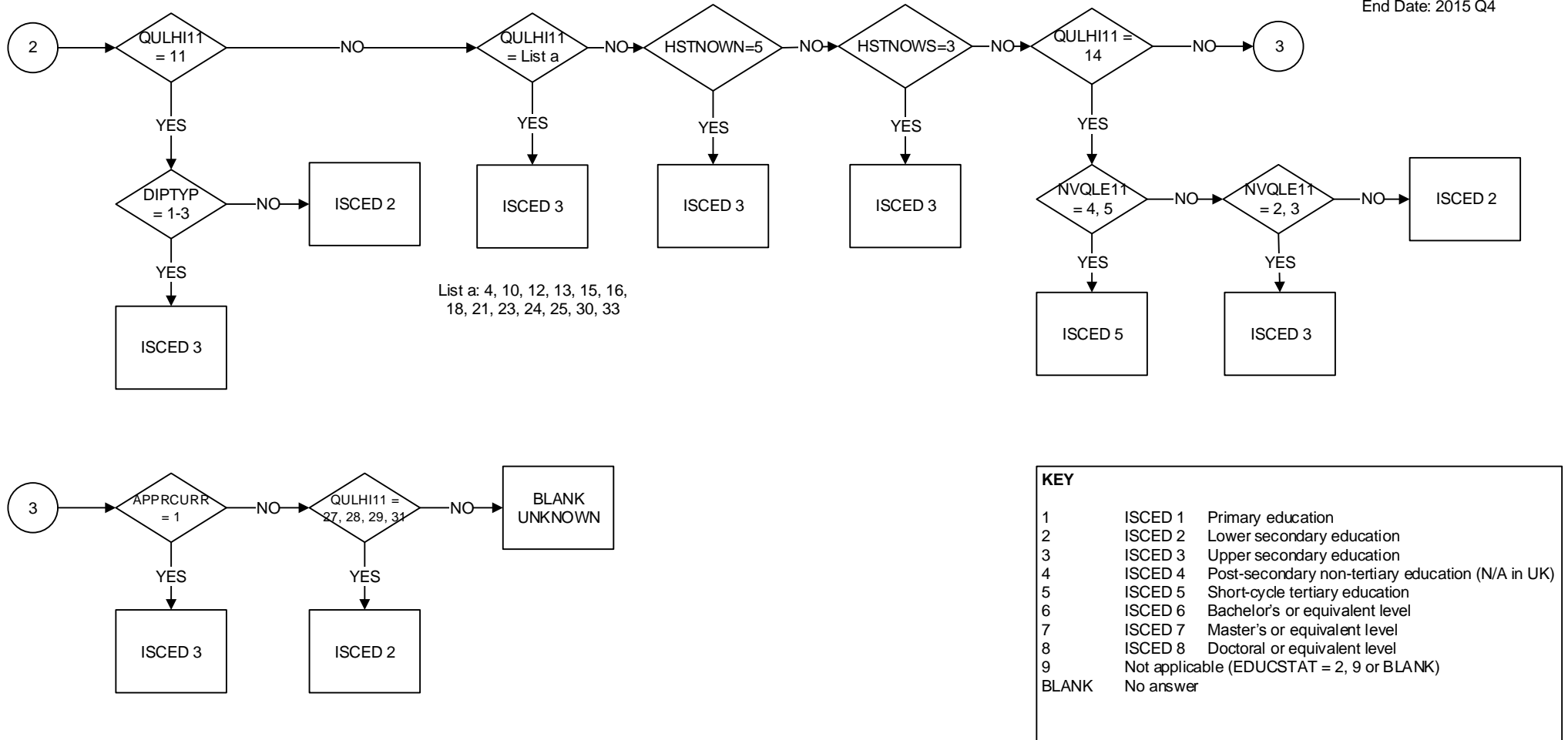

EDUCLEVEL (EDUCLEV16): Level of the current education or training (ISCED11)
Col 209

Start date: 2016 Q1

To 2013 Q4 see Col 124 EDUCLEVEL (EDUCLEV)
From 2014 Q1 to 2014 Q4 see Col 209 EDUCLEVEL (EDUCLEV14)
From 2016 Q1 To 2015 Q4 see Col 209 EDUCLEVEL (EDUCLEV15)

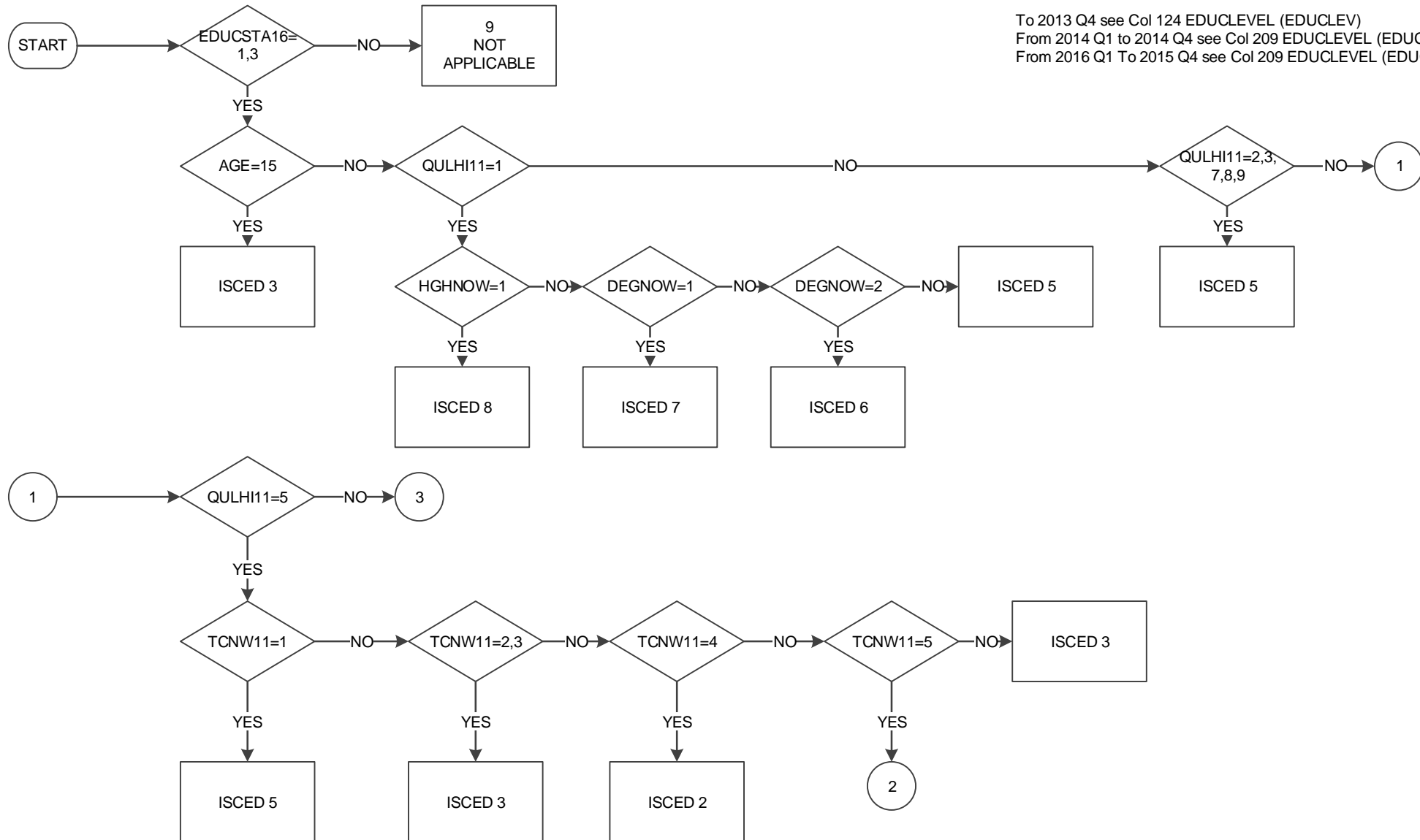

EDUCLEVEL (EDUCLEV16): Level of the current education or training (ISCED11)
Col 209

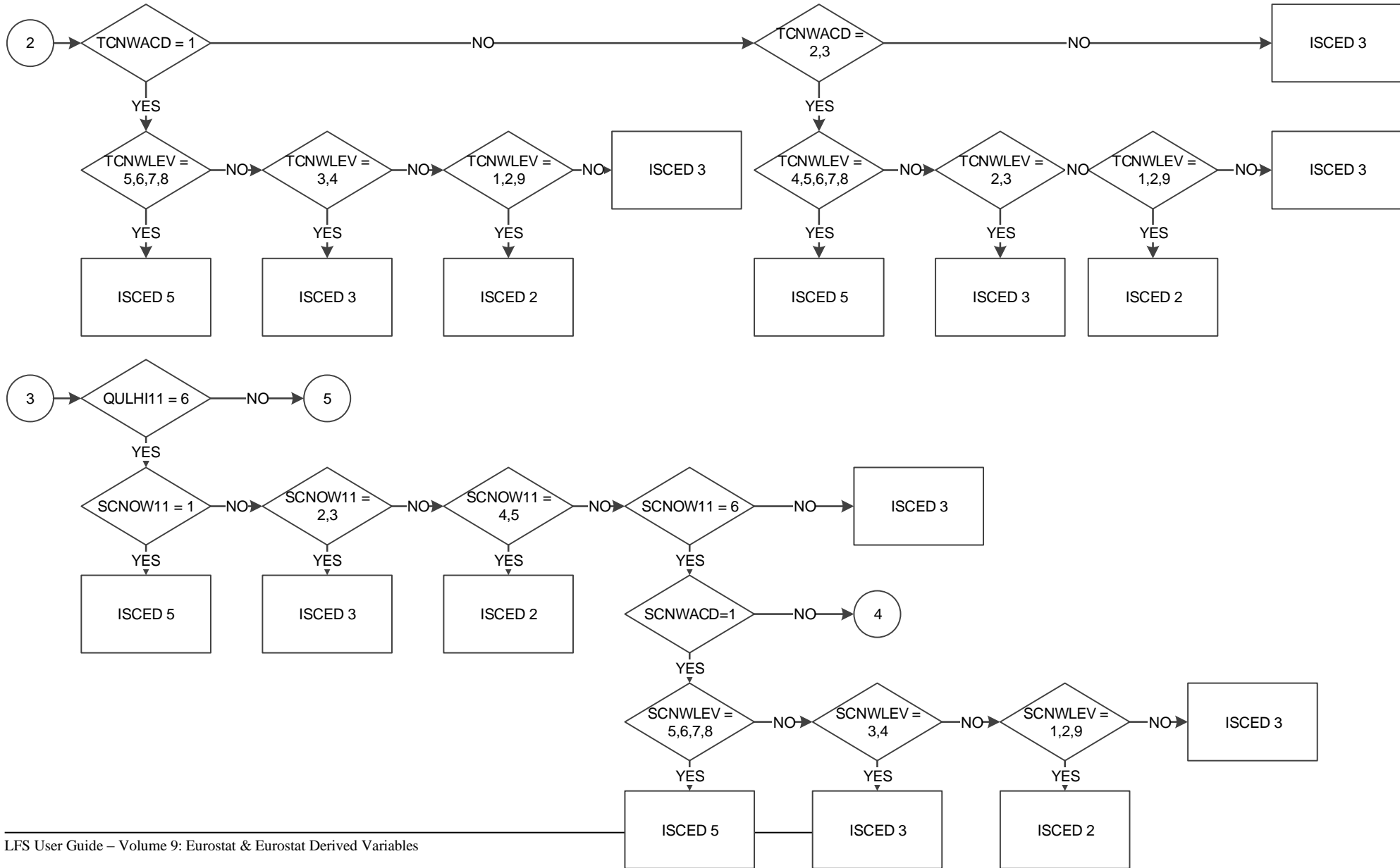

EDUCLEVEL (EDUCLEV16): Level of the current education or training (ISCED11)
Col 209

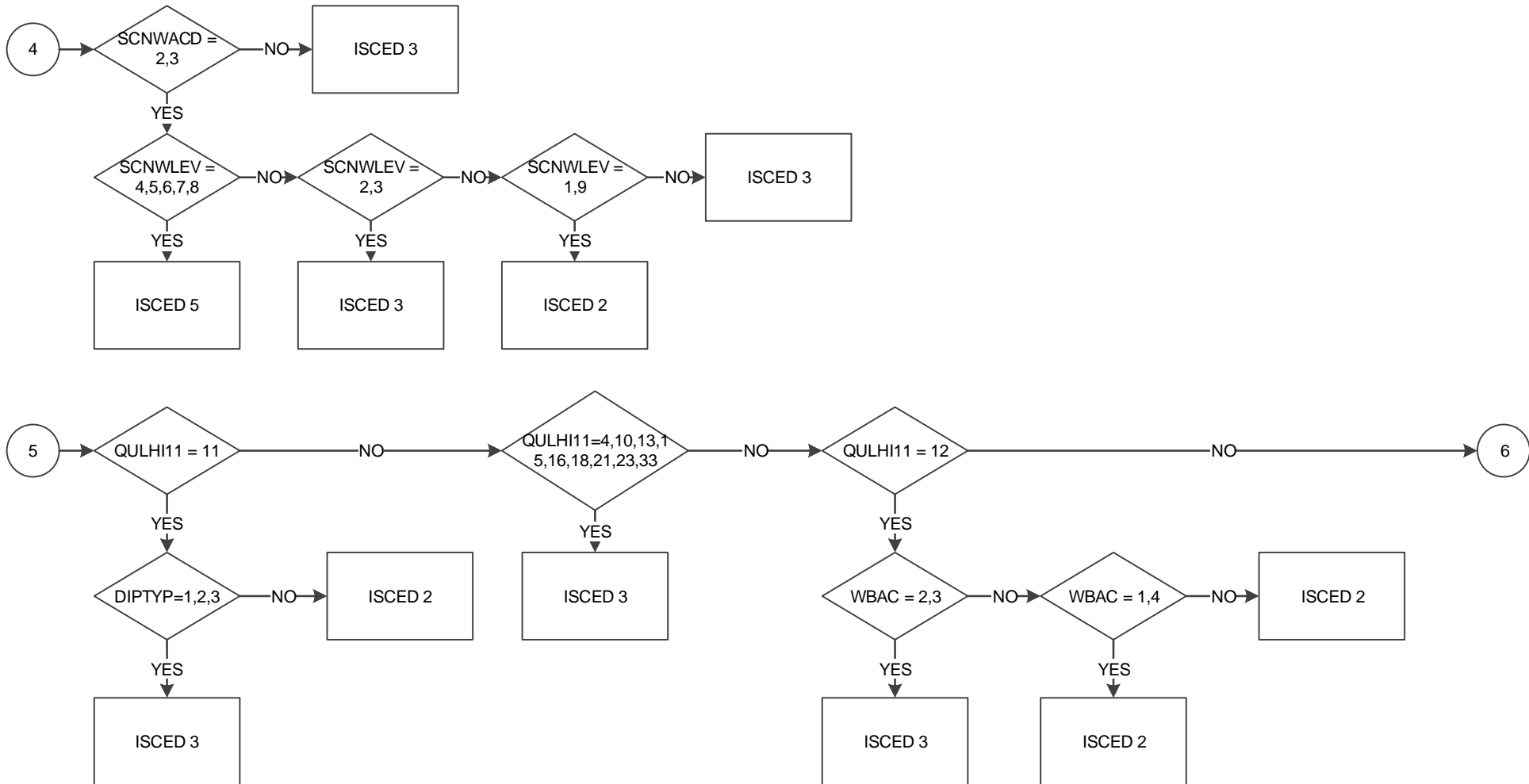

EDUCLEVEL (EDUCLEV16): Level of the current education or training (ISCED11)
Col 209

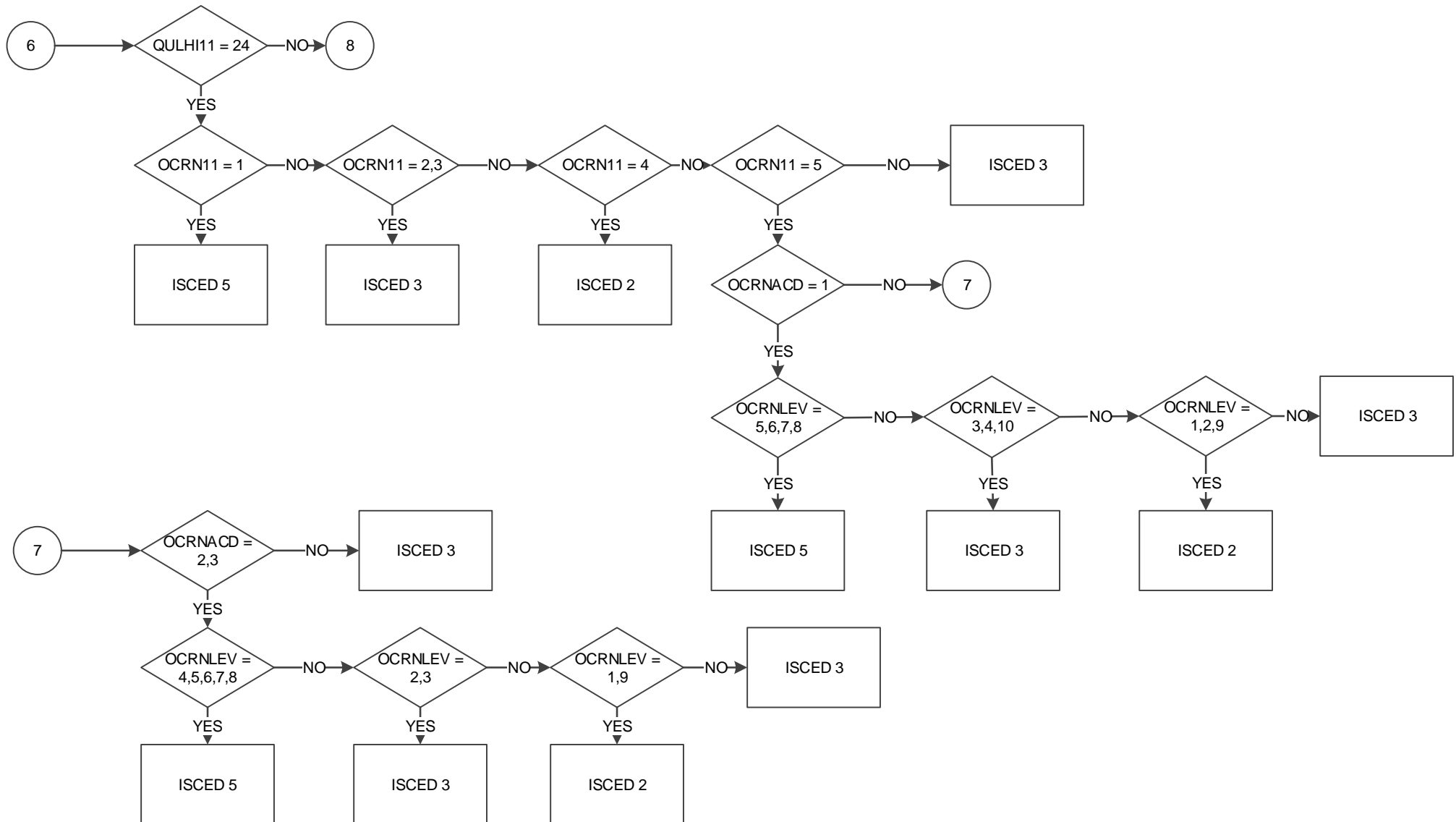

EDUCLEVEL (EDUCLEV16): Level of the current education or training (ISCED11)
Col 209

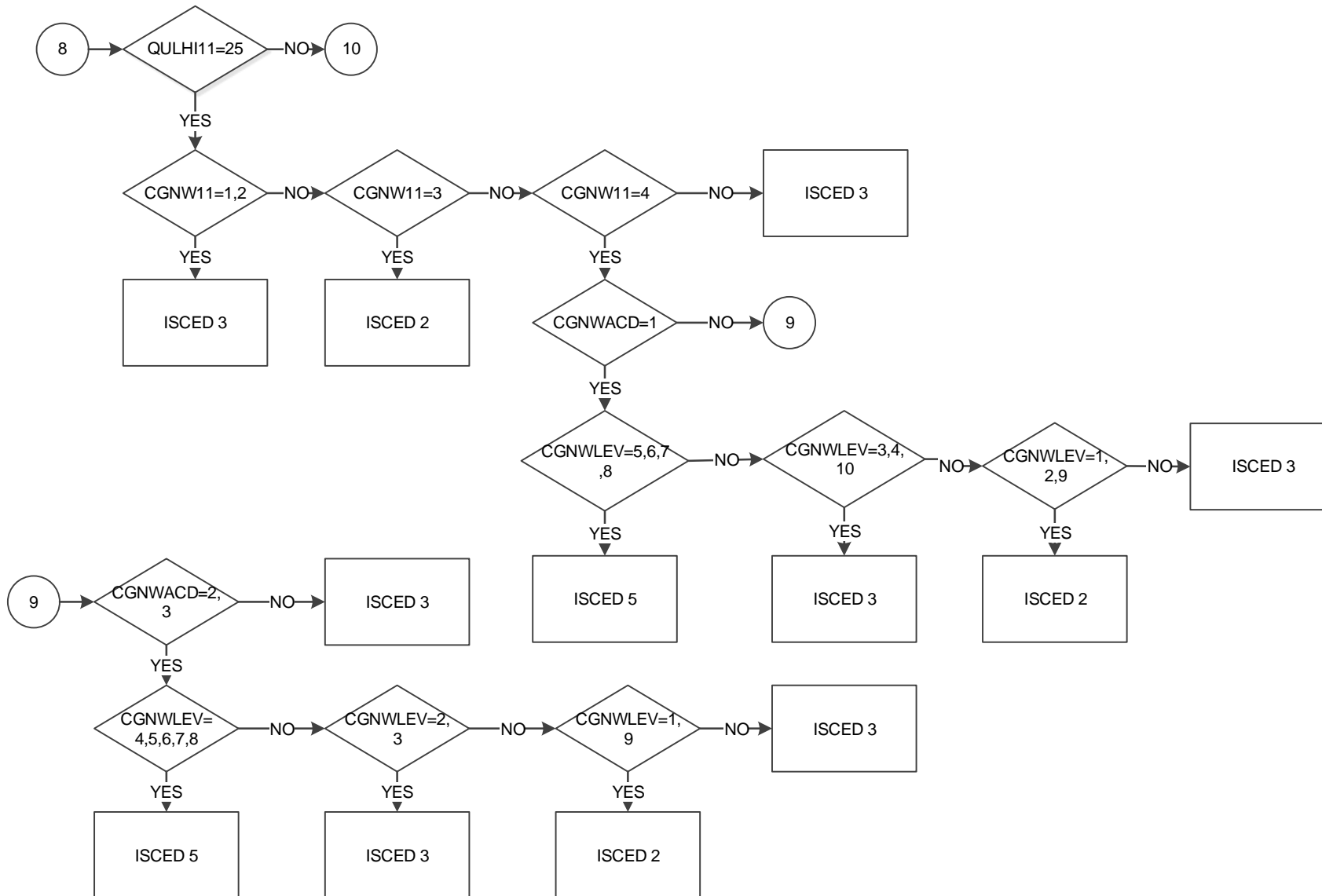

EDUCLEVEL (EDUCLEV16): Level of the current education or training (ISCED11)
Col 209

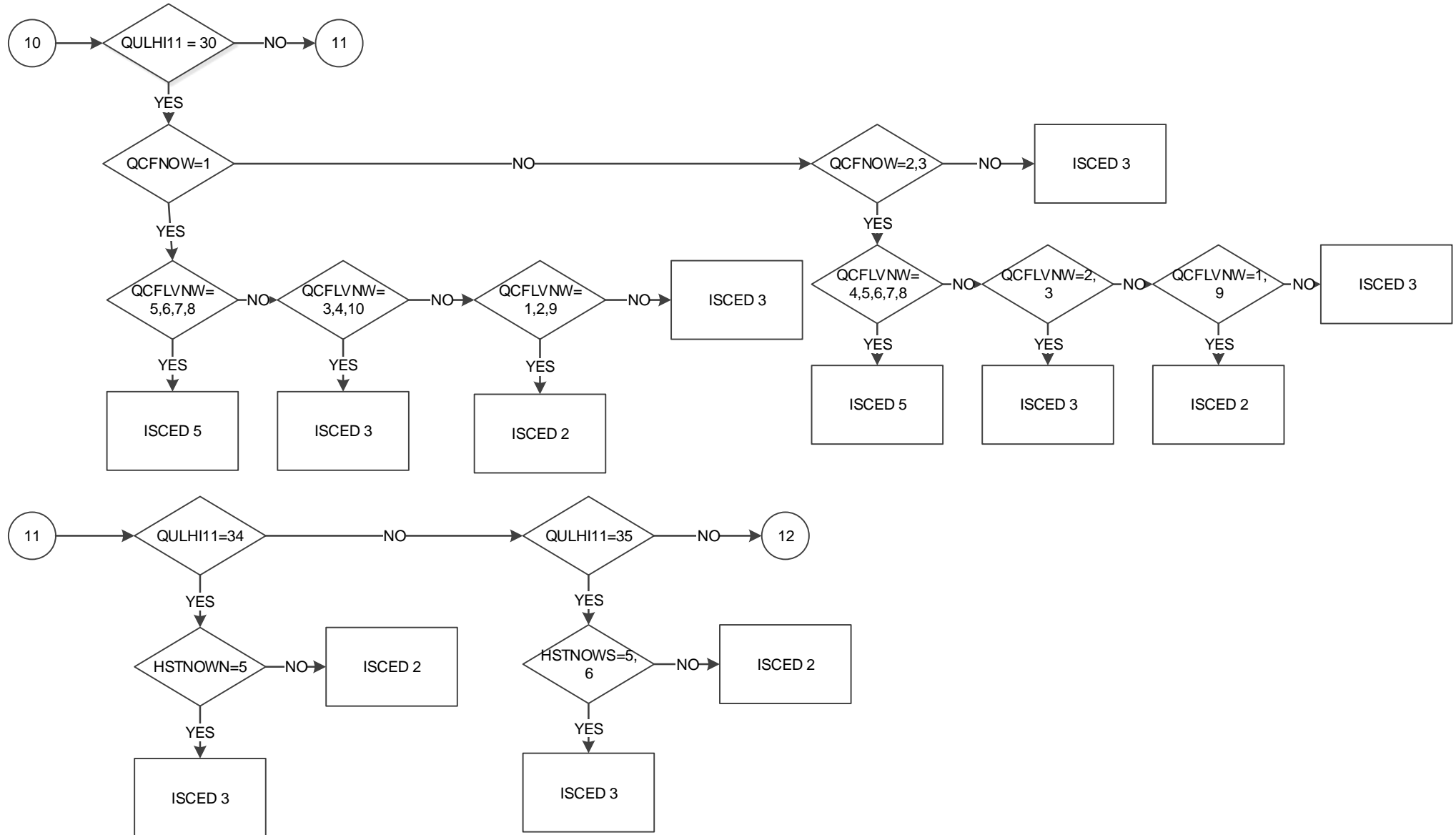

EDUCLEVEL (EDUCLEV16): Level of the current education or training (ISCED11)
Col 209

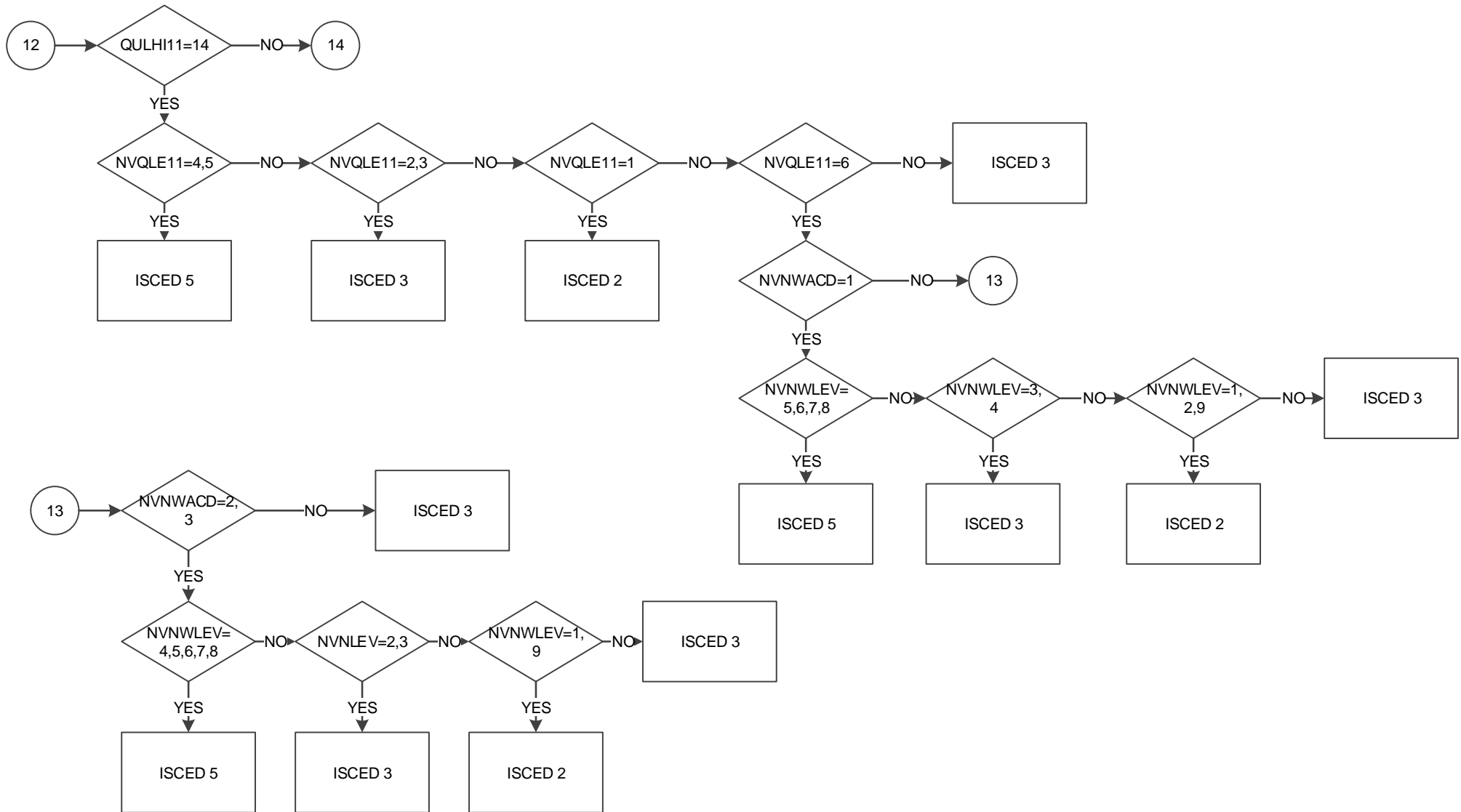

EDUCLEVEL (EDUCLEV16): Level of the current education or training (ISCED11)
Col 209

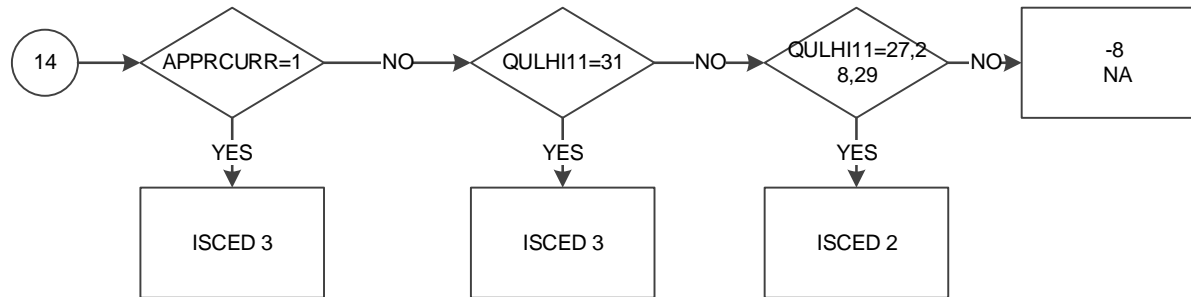

KEY

1	ISCED 1	Primary education
2	ISCED 2	Lower secondary education
3	ISCED 3	Upper secondary education
4	ISCED 4	Post-secondary non-tertiary education (N/A in UK)
5	ISCED 5	Short-cycle tertiary education level
6	ISCED 6	Bachelor's or equivalent level
7	ISCED 7	Master's or equivalent level
8	ISCED 8	Doctoral or equivalent level
9		Not applicable (EDUCSTA16=2,9 or BLANK)

EDUCVOC (EDUCVOC14): Orientation of programme in which person enrolled (i.e. EDUCLEVEL)
 Column 210

Start date: Jan 2014
 End date: Dec 2014

Page 1 of 1

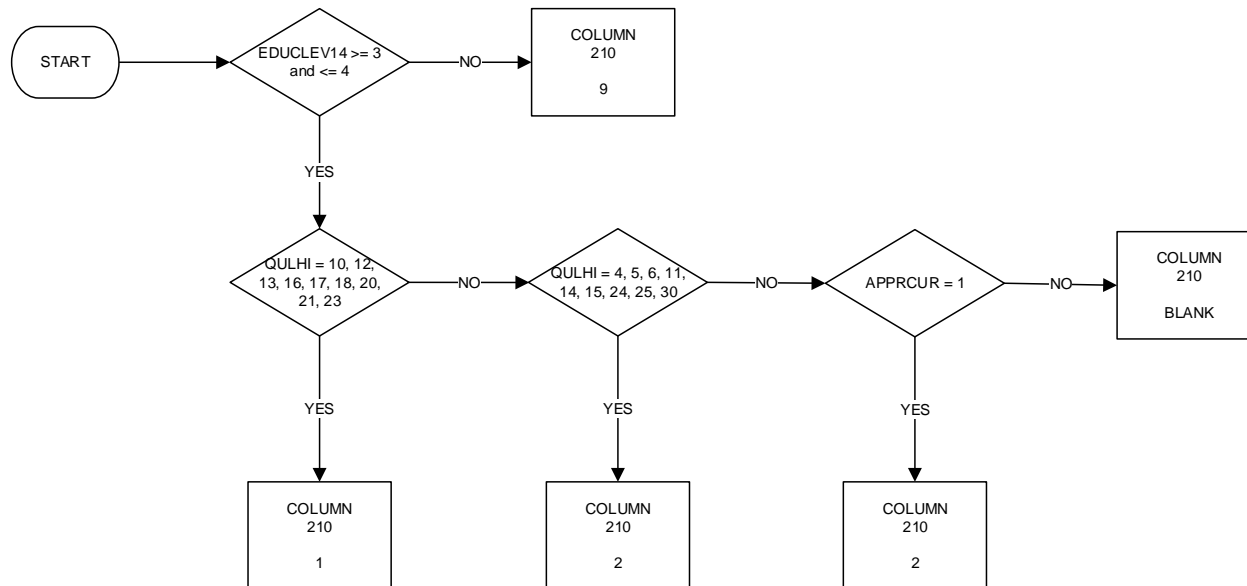

KEY

- 1 General
- 2 Vocational
- 9 Not applicable (EDUCLEVEL ≠ 3 to 4)

For full details see *EU LFS explanatory notes from 2014*, pp 115-116.

EDUCVOC (EDUCVOC15): Orientation of programme in which person enrolled
Col. 210

Start date: 2015 Q1

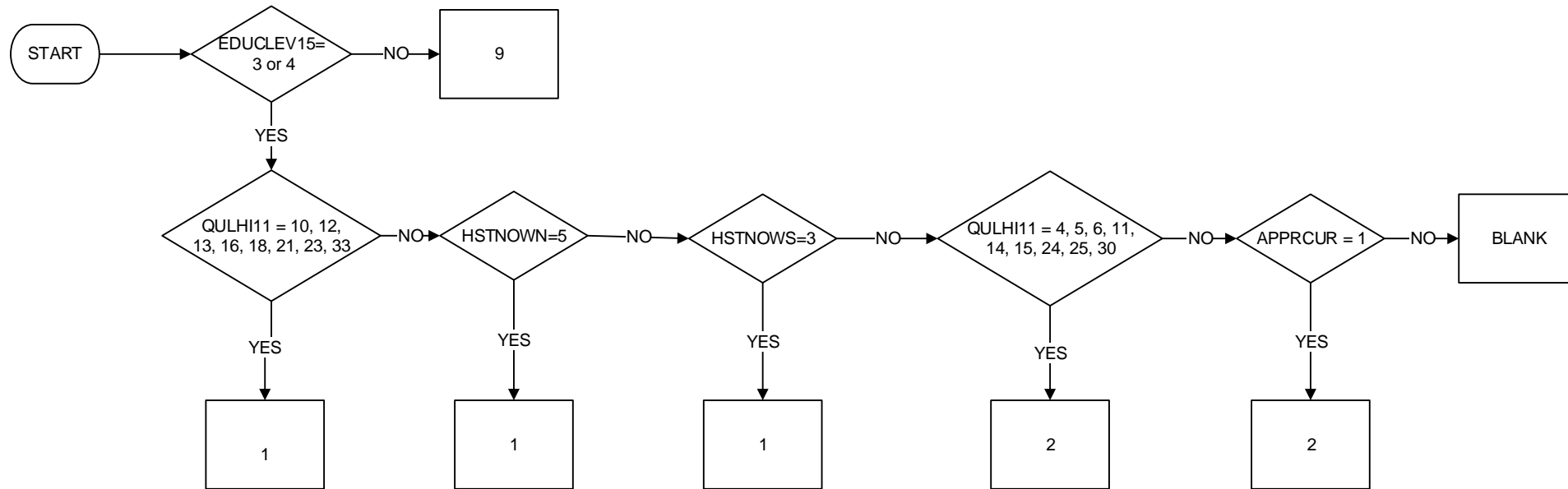

KEY

- 1 General
- 2 Vocational
- 9 Not applicable (EDUCLEVEL ≠ 3 to 4)

For full details see *EU LFS explanatory notes from 2014*, pp 115-116.

ANNEX I UK Regional codes used in the EU-LFS: NUTS10 and NUTS13

NUTS10 (effective 2012 - 2014)

C1 Tees Valley and Durham	C11 Hartlepool and Stockton-on-Tees
	C12 South Teesside
	C13 Darlington
	C14 Durham CC
C2 Northumberland and Tyne and Wear	C21 Northumberland
	C22 Tyneside
	C23 Sunderland
D1 Cumbria	D11 West Cumbria
	D12 East Cumbria
D3 Greater Manchester	D31 Greater Manchester South
	D32 Greater Manchester North
D4 Lancashire	D41 Blackburn with Darwen
	D42 Blackpool
	D43 Lancashire CC
D6 Cheshire	D61 Warrington
	D62 Cheshire East
	D63 Cheshire West and Chester
D7 Merseyside	D71 East Merseyside
	D72 Liverpool
	D73 Sefton
	D74 Wirral
E1 East Riding and North Lincolnshire	E11 Kingston upon Hull, City of
	E12 East Riding of Yorkshire
	E13 North and North East Lincolnshire
E2 North Yorkshire	E21 York
	E22 North Yorkshire CC
E3 South Yorkshire	E31 Barnsley, Doncaster and Rotherham
	E32 Sheffield
E4 West Yorkshire	E41 Bradford
	E42 Leeds
	E44 Calderdale and Kirklees
	E45 Wakefield
F1 Derbyshire and Nottinghamshire	F11 Derby
	F12 East Derbyshire
	F13 South and West Derbyshire
	F14 Nottingham
	F15 North Nottinghamshire
	F16 South Nottinghamshire
F2 Leicestershire, Rutland and Northamptonshire	F21 Leicester
	F22 Leicestershire CC and Rutland
	F24 West Northamptonshire
	F25 North Northamptonshire
F3 Lincolnshire	F30 Lincolnshire

NUTS10 (effective 2012 - 2014)

G1 Herefordshire, Worcestershire and Warwickshire	G11 Herefordshire, County of
	G12 Worcestershire
	G13 Warwickshire
G2 Shropshire and Staffordshire	G21 Telford and Wrekin
	G22 Shropshire CC
	G23 Stoke-on-Trent
	G24 Staffordshire CC
G3 West Midlands	G31 Birmingham
	G32 Solihull
	G33 Coventry
	G36 Dudley
	G37 Sandwell
	G38 Walsall
	G39 Wolverhampton
H1 East Anglia	H11 Peterborough
	H12 Cambridgeshire CC
	H13 Norfolk
	H14 Suffolk
H2 Bedfordshire and Hertfordshire	H21 Luton
	H23 Hertfordshire
	H24 Bedford
	H25 Central Bedfordshire
H3 Essex	H31 Southend-on-Sea
	H32 Thurrock
	H33 Essex CC
I1 Inner London	I11 Inner London - West
	I12 Inner London - East
I2 Outer London	I21 Outer London - East and North East
	I22 Outer London - South
	I23 Outer London - West and North West
J1 Berkshire, Buckinghamshire and Oxfordshire	J11 Berkshire
	J12 Milton Keynes
	J13 Buckinghamshire CC
	J14 Oxfordshire
J2 Surrey East and West Sussex	J21 Brighton and Hove
	J22 East Sussex CC
	J23 Surrey
	J24 West Sussex
J3 Hampshire and Isle of Wight	J31 Portsmouth
	J32 Southampton
	J33 Hampshire CC
	J34 Isle of Wight
J4 Kent	J41 Medway
	J42 Kent CC

NUTS10 (effective 2012 - 2014)

K1 Gloucestershire, Wiltshire and North Somerset	K11 Bristol, City of
	K12 Bath and North East Somerset, North Somerset and South Gloucestershire
	K13 Gloucestershire
	K14 Swindon
	K15 Wiltshire CC
K2 Dorset and Somerset	K21 Bournemouth and Poole
	K22 Dorset CC
	K23 Somerset
K3 Cornwall and Isles of Scilly	K30 Cornwall and Isles of Scilly
K4 Devon	K41 Plymouth
	K42 Torbay
	K43 Devon CC
L1 West Wales and The Valleys	L11 Isle of Anglesey
	L12 Gwynedd
	L13 Conwy and Denbighshire
	L14 South West Wales
	L15 Central Valleys
	L16 Gwent Valleys
	L17 Bridgend and Neath Port Talbot
	L18 Swansea
L2 East Wales	L21 Monmouthshire and Newport
	L22 Cardiff and Vale of Glamorgan
	L23 Flintshire and Wrexham
	L24 Powys
M2 Eastern Scotland	M21 Angus and Dundee City
	M22 Clackmannanshire and Fife
	M23 East Lothian and Midlothian
	M24 Scottish Borders
	M25 Edinburgh, City of
	M26 Falkirk
	M27 Perth & Kinross and Stirling
	M28 West Lothian
M3 South Western Scotland	M31 East Dunbartonshire, West Dunbartonshire and Helensburgh & Lomond
	M32 Dumfries & Galloway
	M33 East Ayrshire and North Ayrshire mainland
	M34 Glasgow City
	M35 Inverclyde, East Renfrewshire and Renfrewshire
	M36 North Lanarkshire
	M37 South Ayrshire
	M38 South Lanarkshire
M5 North Eastern Scotland	M50 Aberdeen City and Aberdeenshire

NUTS10 (effective 2012 - 2014)

M6 Highlands and Islands

M61 Caithness & Sutherland and Ross & Cromarty

M62 Inverness & Nairn and Moray, Badenoch & Strathspey

M63 Lochaber, Skye & Lochalsh, Arran & Cumbrae and Argyll & Bute

M64 Eilean Siar (Western Isles)

M65 Orkney Islands

M66 Shetland Islands

N0 Northern Ireland

N01 Belfast

N02 Outer Belfast

N03 East

N04 North

N05 West and South

NUTS13 (effective 2015 - 2017)

C1 Tees Valley and Durham	C11 Hartlepool and Stockton-on-Tees
	C12 South Teesside
	C13 Darlington
	C14 Durham CC
C2 Northumberland and Tyne and Wear	C21 Northumberland
	C22 Tyneside
	C23 Sunderland
D1 Cumbria	D11 West Cumbria
	D12 East Cumbria
D3 Greater Manchester	D33 Manchester
	D34 Greater Manchester South West
	D35 Greater Manchester South East
	D36 Greater Manchester North West
	D37 Greater Manchester North East
D4 Lancashire	D41 Blackburn with Darwen
	D42 Blackpool
	D44 Lancaster and Wyre
	D45 Mid Lancashire
	D46 East Lancashire
	D47 Chorley and West Lancashire
D6 Cheshire	D61 Warrington
	D62 Cheshire East
	D63 Cheshire West and Chester
D7 Merseyside	D71 East Merseyside
	D72 Liverpool
	D73 Sefton
	D74 Wirral
E1 East Riding and North Lincolnshire	E11 Kingston upon Hull, City of
	E12 East Riding of Yorkshire
	E13 North and North East Lincolnshire
E2 North Yorkshire	E21 York
	E22 North Yorkshire CC
E3 South Yorkshire	E31 Barnsley, Doncaster and Rotherham
	E32 Sheffield
E4 West Yorkshire	E41 Bradford
	E42 Leeds
	E44 Calderdale and Kirklees
	E45 Wakefield
F1 Derbyshire and Nottinghamshire	F11 Derby
	F12 East Derbyshire
	F13 South and West Derbyshire
	F14 Nottingham
	F15 North Nottinghamshire
	F16 South Nottinghamshire

NUTS13 (effective 2015 - 2017)

F2 Leicestershire, Rutland and Northamptonshire	F21 Leicester F22 Leicestershire CC and Rutland F24 West Northamptonshire F25 North Northamptonshire
F3 Lincolnshire G1 Herefordshire, Worcestershire and Warwickshire	F30 Lincolnshire G11 Herefordshire, County of G12 Worcestershire G13 Warwickshire
G2 Shropshire and Staffordshire	G21 Telford and Wrekin G22 Shropshire CC G23 Stoke-on-Trent G24 Staffordshire CC
G3 West Midlands	G31 Birmingham G32 Solihull G33 Coventry G36 Dudley G37 Sandwell G38 Walsall G39 Wolverhampton
H1 East Anglia	H11 Peterborough H12 Cambridgeshire CC H14 Suffolk H15 Norwich and East Norfolk H16 North and West Norfolk H17 Breckland and South Norfolk
H2 Bedfordshire and Hertfordshire	H21 Luton H23 Hertfordshire H24 Bedford H25 Central Bedfordshire
H3 Essex	H31 Southend-on-Sea H32 Thurrock H34 Essex Haven Gateway H35 West Essex H36 Heart of Essex H37 Essex Thames Gateway
I3 Inner London - West	I31 Camden and City of London I32 Westminster I33 Kensington & Chelsea and Hammersmith & Fulham I34 Wandsworth
I4 Inner London - East	I41 Hackney and Newham I42 Towers Hamlets I43 Haringey and Islington I44 Lewisham and Southwark I45 Lambeth

NUTS13 (effective 2015 - 2017)

I5 Outer London - East and North East	I51 Bexley and Greenwich I52 Barking & Dagenham and Havering I53 Redbridge and Waltham Forest I54 Enfield
I6 Outer London - South	I61 Bromley I62 Croydon I63 Merton, Kingston upon Thames and Sutton
I7 Outer London - West and North West	I71 Barnet I72 Brent I73 Ealing I74 Harrow and Hillingdon I75 Hounslow and Richmond upon Thames
J1 Berkshire, Buckinghamshire and Oxfordshire	J11 Berkshire J12 Milton Keynes J13 Buckinghamshire CC J14 Oxfordshire
J2 Surrey East and West Sussex	J21 Brighton and Hove J22 East Sussex CC J25 West Surrey J26 East Surrey J27 West Sussex (South West) J28 West Sussex (North East)
J3 Hampshire and Isle of Wight	J31 Portsmouth J32 Southampton J34 Isle of Wight J35 South Hampshire J36 Central Hampshire J37 North Hampshire
J4 Kent	J41 Medway J43 Kent Thames Gateway J44 East Kent J45 Mid Kent J46 West Kent
K1 Gloucestershire, Wiltshire and North Somerset	K11 Bristol, City of K12 Bath and North East Somerset, North Somerset and South Gloucestershire K13 Gloucestershire K14 Swindon K15 Wiltshire CC
K2 Dorset and Somerset	K21 Bournemouth and Poole K22 Dorset CC K23 Somerset
K3 Cornwall and Isles of Scilly	K30 Cornwall and Isles of Scilly
K4 Devon	K41 Plymouth K42 Torbay K43 Devon CC

NUTS13 (effective 2015 - 2017)

L1 West Wales and The Valleys	L11 Isle of Anglesey
	L12 Gwynedd
	L13 Conwy and Denbighshire
	L14 South West Wales
	L15 Central Valleys
	L16 Gwent Valleys
	L17 Bridgend and Neath Port Talbot
	L18 Swansea
L2 East Wales	L21 Monmouthshire and Newport
	L22 Cardiff and Vale of Glamorgan
	L23 Flintshire and Wrexham
	L24 Powys
M2 Eastern Scotland	M21 Angus and Dundee City
	M22 Clackmannanshire and Fife
	M23 East Lothian and Midlothian
	M24 Scottish Borders
	M25 Edinburgh, City of
	M26 Falkirk
	M27 Perth & Kinross and Stirling
	M28 West Lothian
M3 South Western Scotland	M31 East Dunbartonshire, West Dunbartonshire and Helensburgh & Lomond
	M32 Dumfries & Galloway
	M33 East Ayrshire and North Ayrshire mainland
	M34 Glasgow City
	M35 Inverclyde, East Renfrewshire and Renfrewshire
	M36 North Lanarkshire
	M37 South Ayrshire
	M38 South Lanarkshire
M5 North Eastern Scotland	M50 Aberdeen City and Aberdeenshire
M6 Highlands and Islands	M61 Caithness & Sutherland and Ross & Cromarty
	M62 Inverness & Nairn and Moray, Badenoch & Strathspey
	M63 Lochaber, Skye & Lochalsh, Arran & Cumbrae and Argyll & Bute
	M64 Eilean Siar (Western Isles)
	M65 Orkney Islands
	M66 Shetland Islands
N0 Northern Ireland	N01 Belfast
	N02 Outer Belfast
	N03 East
	N04 North
	N05 West and South

**ANNEX II Statistical Classification of economic activities at 2 and 3 digits
(NACE Rev. 2 – used from 2009 onwards)**

<i>A</i>	<i>AGRICULTURE, FORESTRY AND FISHING</i>
01	Crop and animal production, hunting and related service activities
01.1	Growing of non-perennial crops
01.2	Growing of perennial crops
01.3	Plant propagation
01.4	Animal production
01.5	Mixed farming
01.6	Support activities to agriculture and post-harvest crop activities
01.7	Hunting, trapping and related service activities
02	Forestry and logging
02.1	Silviculture and other forestry activities
02.2	Logging
02.3	Gathering of wild growing non-wood products
02.4	Support services to forestry
03	Fishing and aquaculture
03.1	Fishing
03.2	Aquaculture
<i>B</i>	<i>MINING AND QUARRYING</i>
05	Mining of coal and lignite
05.1	Mining of hard coal
05.2	Mining of lignite
06	Extraction of crude petroleum and natural gas
06.1	Extraction of crude petroleum
06.2	Extraction of natural gas
07	Mining of metal ores
07.1	Mining of iron ores
07.2	Mining of non-ferrous metal ores
08	Other mining and quarrying
08.1	Quarrying of stone, sand and clay
08.9	Mining and quarrying n.e.c.
09	Mining support service activities
09.1	Support activities for petroleum and natural gas extraction
09.9	Support activities for other mining and quarrying
<i>C</i>	<i>MANUFACTURING</i>
10	Manufacture of food products
10.1	Processing and preserving of meat and production of meat products
10.2	Processing and preserving of fish, crustaceans and molluscs
10.3	Processing and preserving of fruit and vegetables
10.4	Manufacture of vegetable and animal oils and fats
10.5	Manufacture of dairy products
10.6	Manufacture of grain mill products, starches and starch products
10.7	Manufacture of bakery and farinaceous products
10.8	Manufacture of other food products

10.9	Manufacture of prepared animal feeds
11	Manufacture of beverages
11.0	Manufacture of beverages
12	Manufacture of tobacco products
12.0	Manufacture of tobacco products
13	Manufacture of textiles
13.1	Preparation and spinning of textile fibres
13.2	Weaving of textiles
13.3	Finishing of textiles
13.9	Manufacture of other textiles
14	Manufacture of wearing apparel
14.1	Manufacture of wearing apparel, except fur apparel
14.2	Manufacture of articles of fur
14.3	Manufacture of knitted and crocheted apparel
15	Manufacture of leather and related products
15.1	Tanning and dressing of leather; manufacture of luggage, handbags, saddlery and harness; dressing and dyeing of fur
15.2	Manufacture of footwear
16	Manufacture of wood and of products of wood and cork, except furniture; manufacture of articles of straw and plaiting materials
16.1	Sawmilling and planing of wood
16.2	Manufacture of products of wood, cork, straw and plaiting materials
17	Manufacture of paper and paper products
17.1	Manufacture of pulp, paper and paperboard
17.2	Manufacture of articles of paper and paperboard
18	Printing and reproduction of recorded media
18.1	Printing and service activities related to printing
18.2	Reproduction of recorded media
19	Manufacture of coke and refined petroleum products
19.1	Manufacture of coke oven products
19.2	Manufacture of refined petroleum products
20	Manufacture of chemicals and chemical products
20.1	Manufacture of basic chemicals, fertilisers and nitrogen compounds, plastics and synthetic rubber in primary forms
20.2	Manufacture of pesticides and other agrochemical products
20.3	Manufacture of paints, varnishes and similar coatings, printing ink and mastics
20.4	Manufacture of soap and detergents, cleaning and polishing preparations, perfumes and toilet preparations
20.5	Manufacture of other chemical products
20.6	Manufacture of man-made fibres
21	Manufacture of basic pharmaceutical products and pharmaceutical preparations
21.1	Manufacture of basic pharmaceutical products
21.2	Manufacture of pharmaceutical preparations
22	Manufacture of rubber and plastic products
22.1	Manufacture of rubber products
22.2	Manufacture of plastics products
23	Manufacture of other non-metallic mineral products
23.1	Manufacture of glass and glass products
23.2	Manufacture of refractory products
23.3	Manufacture of clay building materials
23.4	Manufacture of other porcelain and ceramic products

23.5	Manufacture of cement, lime and plaster
23.6	Manufacture of articles of concrete, cement and plaster
23.7	Cutting, shaping and finishing of stone
23.9	Manufacture of abrasive products and non-metallic mineral products n.e.c.
24	Manufacture of basic metals
24.1	Manufacture of basic iron and steel and of ferro-alloys
24.2	Manufacture of tubes, pipes, hollow profiles and related fittings, of steel
24.3	Manufacture of other products of first processing of steel
24.4	Manufacture of basic precious and other non-ferrous metals
24.5	Casting of metals
25	Manufacture of fabricated metal products, except machinery and equipment
25.1	Manufacture of structural metal products
25.2	Manufacture of tanks, reservoirs and containers of metal
25.3	Manufacture of steam generators, except central heating hot water boilers
25.4	Manufacture of weapons and ammunition
25.5	Forging, pressing, stamping and roll-forming of metal; powder metallurgy
25.6	Treatment and coating of metals; machining
25.7	Manufacture of cutlery, tools and general hardware
25.9	Manufacture of other fabricated metal products
26	Manufacture of computer, electronic and optical products
26.1	Manufacture of electronic components and boards
26.2	Manufacture of computers and peripheral equipment
26.3	Manufacture of communication equipment
26.4	Manufacture of consumer electronics
26.5	Manufacture of instruments and appliances for measuring, testing and navigation; watches and clocks
26.6	Manufacture of irradiation, electromedical and electrotherapeutic equipment
26.7	Manufacture of optical instruments and photographic equipment
26.8	Manufacture of magnetic and optical media
27	Manufacture of electrical equipment
27.1	Manufacture of electric motors, generators, transformers and electricity distribution and control apparatus
27.2	Manufacture of batteries and accumulators
27.3	Manufacture of wiring and wiring devices
27.4	Manufacture of electric lighting equipment
27.5	Manufacture of domestic appliances
27.9	Manufacture of other electrical equipment
28	Manufacture of machinery and equipment n.e.c.
28.1	Manufacture of general — purpose machinery
28.2	Manufacture of other general-purpose machinery
28.3	Manufacture of agricultural and forestry machinery
28.4	Manufacture of metal forming machinery and machine tools
28.9	Manufacture of other special-purpose machinery
29	Manufacture of motor vehicles, trailers and semi-trailers
29.1	Manufacture of motor vehicles
29.2	Manufacture of bodies (coachwork) for motor vehicles; manufacture of trailers and semi-trailers
29.3	Manufacture of parts and accessories for motor vehicles
30	Manufacture of other transport equipment
30.1	Building of ships and boats
30.2	Manufacture of railway locomotives and rolling stock
30.3	Manufacture of air and spacecraft and related machinery
30.4	Manufacture of military fighting vehicles

30.9	Manufacture of transport equipment n.e.c.
31	Manufacture of furniture
31.0	Manufacture of furniture
32	Other manufacturing
32.1	Manufacture of jewellery, bijouterie and related articles
32.2	Manufacture of musical instruments
32.3	Manufacture of sports goods
32.4	Manufacture of games and toys
32.5	Manufacture of medical and dental instruments and supplies
32.9	Manufacturing n.e.c.
33	Repair and installation of machinery and equipment
33.1	Repair of fabricated metal products, machinery and equipment
33.2	Installation of industrial machinery and equipment
<i>D</i>	<i>ELECTRICITY, GAS, STEAM AND AIR CONDITIONING SUPPLY</i>
35	Electricity, gas, steam and air conditioning supply
35.1	Electric power generation, transmission and distribution
35.2	Manufacture of gas; distribution of gaseous fuels through mains
35.3	Steam and air conditioning supply
<i>E</i>	<i>WATER SUPPLY; SEWERAGE, WASTE MANAGEMENT AND REMEDIATION ACTIVITIES</i>
36	Water collection, treatment and supply
36.0	Water collection, treatment and supply
37	Sewerage
37.0	Sewerage
38	Waste collection, treatment and disposal activities; materials recovery
38.1	Waste collection
38.2	Waste treatment and disposal
38.3	Materials recovery
39	Remediation activities and other waste management services
39.0	Remediation activities and other waste management services
<i>F</i>	<i>CONSTRUCTION</i>
41	Construction of buildings
41.1	Development of building projects
41.2	Construction of residential and non-residential buildings
42	Civil engineering
42.1	Construction of roads and railways
42.2	Construction of utility projects
42.9	Construction of other civil engineering projects
43	Specialised construction activities
43.1	Demolition and site preparation
43.2	Electrical, plumbing and other construction installation activities
43.3	Building completion and finishing
43.9	Other specialised construction activities
<i>G</i>	<i>WHOLESALE AND RETAIL TRADE; REPAIR OF MOTOR VEHICLES AND MOTORCYCLES</i>

45	Wholesale and retail trade and repair of motor vehicles and motorcycles
45.1	Sale of motor vehicles
45.2	Maintenance and repair of motor vehicles
45.3	Sale of motor vehicle parts and accessories
45.4	Sale, maintenance and repair of motorcycles and related parts and accessories
46	Wholesale trade, except of motor vehicles and motorcycles
46.2	Wholesale of agricultural raw materials and live animals
46.3	Wholesale of food, beverages and tobacco
46.4	Wholesale of household goods
46.5	Wholesale of information and communication equipment
46.6	Wholesale of other machinery, equipment and supplies
46.7	Other specialised wholesale
46.9	Non-specialised wholesale trade
47	Retail trade, except of motor vehicles and motorcycles
47.1	Retail sale in non-specialised stores
47.2	Retail sale of food, beverages and tobacco in specialised stores
47.3	Retail sale of automotive fuel in specialised stores
47.4	Retail sale of information and communication equipment in specialised stores
47.5	Retail sale of other household equipment in specialised stores
47.6	Retail sale of cultural and recreation goods in specialised stores
47.7	Retail sale of other goods in specialised stores
47.8	Retail sale via stalls and markets
47.9	Retail trade not in stores, stalls or markets

H TRANSPORTATION AND STORAGE

49	Land transport and transport via pipelines
49.1	Passenger rail transport, interurban
49.2	Freight rail transport
49.3	Other passenger land transport
49.4	Freight transport by road and removal services
49.5	Transport via pipeline
50	Water transport
50.1	Sea and coastal passenger water transport
50.2	Sea and coastal freight water transport
50.3	Inland passenger water transport
50.4	Inland freight water transport
51	Air transport
51.1	Passenger air transport
51.2	Freight air transport and space transport
52	Warehousing and support activities for transportation
52.1	Warehousing and storage
52.2	Support activities for transportation
53	Postal and courier activities
53.1	Postal activities under universal service obligation
53.2	Other postal and courier activities

I ACCOMMODATION AND FOOD SERVICE ACTIVITIES

55	Accommodation
55.1	Hotels and similar accommodation
55.2	Holiday and other short-stay accommodation
55.3	Camping grounds, recreational vehicle parks and trailer parks
55.9	Other accommodation
56	Food and beverage service activities
56.1	Restaurants and mobile food service activities
56.2	Event catering and other food service activities
56.3	Beverage serving activities
<i>J</i>	<i>INFORMATION AND COMMUNICATION</i>
58	Publishing activities
58.1	Publishing of books, periodicals and other publishing activities
58.2	Software publishing
59	Motion picture, video and television programme production, sound recording and music publishing activities
59.1	Motion picture, video and television programme activities
59.2	Sound recording and music publishing activities
60	Programming and broadcasting activities
60.1	Radio broadcasting
60.2	Television programming and broadcasting activities
61	Telecommunications
61.1	Wired telecommunications activities
61.2	Wireless telecommunications activities
61.3	Satellite telecommunications activities
61.9	Other telecommunications activities
62	Computer programming, consultancy and related activities
62.0	Computer programming, consultancy and related activities
63	Information service activities
63.1	Data processing, hosting and related activities; web portals
63.9	Other information service activities
<i>K</i>	<i>FINANCIAL AND INSURANCE ACTIVITIES</i>
64	Financial service activities, except insurance and pension funding
64.1	Monetary intermediation
64.2	Activities of holding companies
64.3	Trusts, funds and similar financial entities
64.9	Other financial service activities, except insurance and pension funding
65	Insurance, reinsurance and pension funding, except compulsory social security
65.1	Insurance
65.2	Reinsurance
65.3	Pension funding
66	Activities auxiliary to financial services and insurance activities
66.1	Activities auxiliary to financial services, except insurance and pension funding
66.2	Activities auxiliary to insurance and pension funding
66.3	Fund management activities
<i>L</i>	<i>REAL ESTATE ACTIVITIES</i>

68	Real estate activities
68.1	Buying and selling of own real estate
68.2	Renting and operating of own or leased real estate
68.3	Real estate activities on a fee or contract basis
<i>M</i>	<i>PROFESSIONAL, SCIENTIFIC AND TECHNICAL ACTIVITIES</i>
69	Legal and accounting activities
69.1	Legal activities
69.2	Accounting, bookkeeping and auditing activities; tax consultancy
70	Activities of head offices; management consultancy activities
70.1	Activities of head offices
70.2	Management consultancy activities
71	Architectural and engineering activities; technical testing and analysis
71.1	Architectural and engineering activities and related technical consultancy
71.2	Technical testing and analysis
72	Scientific research and development
72.1	Research and experimental development on natural sciences and engineering
72.2	Research and experimental development on social sciences and humanities
73	Advertising and market research
73.1	Advertising
73.2	Market research and public opinion polling
74	Other professional, scientific and technical activities
74.1	Specialised design activities
74.2	Photographic activities
74.3	Translation and interpretation activities
74.9	Other professional, scientific and technical activities n.e.c.
75	Veterinary activities
75.0	Veterinary activities
<i>N</i>	<i>ADMINISTRATIVE AND SUPPORT SERVICE ACTIVITIES</i>
77	Rental and leasing activities
77.1	Renting and leasing of motor vehicles
77.2	Renting and leasing of personal and household goods
77.3	Renting and leasing of other machinery, equipment and tangible goods
77.4	Leasing of intellectual property and similar products, except copyrighted works
78	Employment activities
78.1	Activities of employment placement agencies
78.2	Temporary employment agency activities
78.3	Other human resources provision
79	Travel agency, tour operator reservation service and related activities
79.1	Travel agency and tour operator activities
79.9	Other reservation service and related activities
80	Security and investigation activities
80.1	Private security activities
80.2	Security systems service activities
80.3	Investigation activities
81	Services to buildings and landscape activities

81.1	Combined facilities support activities
81.2	Cleaning activities
81.3	Landscape service activities
82	Office administrative, office support and other business support activities
82.1	Office administrative and support activities
82.2	Activities of call centres
82.3	Organisation of conventions and trade shows
82.9	Business support service activities n.e.c.
<i>O</i>	<i>PUBLIC ADMINISTRATION AND DEFENCE; COMPULSORY SOCIAL SECURITY</i>
84	Public administration and defence; compulsory social security
84.1	Administration of the State and the economic and social policy of the community
84.2	Provision of services to the community as a whole
84.3	Compulsory social security activities
<i>P</i>	<i>EDUCATION</i>
85	Education
85.1	Pre-primary education
85.2	Primary education
85.3	Secondary education
85.4	Higher education
85.5	Other education
85.6	Educational support activities
<i>Q</i>	<i>HUMAN HEALTH AND SOCIAL WORK ACTIVITIES</i>
86	Human health activities
86.1	Hospital activities
86.2	Medical and dental practice activities
86.9	Other human health activities
87	Residential care activities
87.1	Residential nursing care activities
87.2	Residential care activities for mental retardation, mental health and substance abuse
87.3	Residential care activities for the elderly and disabled
87.9	Other residential care activities
88	Social work activities without accommodation
88.1	Social work activities without accommodation for the elderly and disabled
88.9	Other social work activities without accommodation
<i>R</i>	<i>ARTS, ENTERTAINMENT AND RECREATION</i>
90	Creative, arts and entertainment activities
90.0	Creative, arts and entertainment activities
91	Libraries, archives, museums and other cultural activities
91.0	Libraries, archives, museums and other cultural activities
92	Gambling and betting activities
92.0	Gambling and betting activities
93	Sports activities and amusement and recreation activities

93.1	Sports activities
93.2	Amusement and recreation activities
<i>S</i>	<i>OTHER SERVICE ACTIVITIES</i>
94	Activities of membership organisations
94.1	Activities of business, employers and professional membership organisations
94.2	Activities of trade unions
94.9	Activities of other membership organisations
95	Repair of computers and personal and household goods
95.1	Repair of computers and communication equipment
95.2	Repair of personal and household goods
96	Other personal service activities
96.0	Other personal service activities
<i>T</i>	<i>ACTIVITIES OF HOUSEHOLDS AS EMPLOYERS; UNDIFFERENTIATED GOODS- AND SERVICES- PRODUCING ACTIVITIES OF HOUSEHOLDS FOR OWN USE</i>
97	Activities of households as employers of domestic personnel
97.0	Activities of households as employers of domestic personnel
98	Undifferentiated goods- and services-producing activities of private households for own use
98.1	Undifferentiated goods-producing activities of private households for own use
98.2	Undifferentiated service-producing activities of private households for own use
<i>U</i>	<i>ACTIVITIES OF EXTRATERRITORIAL ORGANISATIONS AND BODIES</i>
99	Activities of extraterritorial organisations and bodies
99.0	Activities of extraterritorial organisations and bodies

ANNEX III (a) – International Standard Classification of Occupations 2, 3 and 4 digits (ISCO-88 (com))

MAJOR GROUP 1: LEGISLATORS, SENIOR OFFICIALS AND MANAGERS

11	Legislators and senior officials
111	Legislators and senior government officials
1110	Legislators and senior government officials
114	Senior officials of special-interest organisations
1141	Senior officials of political party organisations
1142	Senior officials of employers', workers' and other economic-interest organisations
1143	Senior officials of humanitarian and other special-interest organisations
12	Corporate managers
121	Directors and chief executives
1210	Directors and chief executives
122	Production and operations managers
1221	Production and operations managers in agriculture, hunting, forestry and fishing
1222	Production and operations managers in manufacturing
1223	Production and operations managers in construction
1224	Production and operations managers in wholesale and retail trade
1225	Production and operations managers in restaurants and hotels
1226	Production and operations managers in transport, storage and communications
1227	Production and operations managers in business services enterprises
1228	Production and operations managers in personal care, cleaning and related services
1229	Production and operations managers not elsewhere classified
123	Other specialist managers
1231	Finance and administration managers
1232	Personnel and industrial relations managers
1233	Sales and marketing managers
1234	Advertising and public relations managers
1235	Supply and distribution managers
1236	Computing services managers
1237	Research and development managers
1239	Other specialist managers not elsewhere classified
13	Managers of small enterprises
131	Managers of small enterprises
1311	Managers of small enterprises in agriculture, hunting, forestry and fishing
1312	Managers of small enterprises in manufacturing
1313	Managers of small enterprises in construction
1314	Managers of small enterprises in wholesale and retail trade
1315	Managers of small enterprises of restaurants and hotels
1316	Managers of small enterprises in transport, storage and communications
1317	Managers of small enterprises in business services enterprises
1318	Managers of small enterprises in personal care, cleaning and related services
1319	Managers of small enterprises not elsewhere classified

MAJOR GROUP 2: PROFESSIONALS

21	Physical, mathematical and engineering science professionals
211	Physicists, chemists and related professionals
2111	Physicists and astronomers
2112	Meteorologists
2113	Chemists
2114	Geologists and geophysicists
212	Mathematicians, statisticians and related professionals
2121	Mathematicians and related professionals
2122	Statisticians
213	Computing professionals
2131	Computer systems designers, analysts and programmers
2139	Computing professionals not elsewhere classified
214	Architects, engineers and related professionals
2141	Architects, town and traffic planners
2142	Civil engineers

	2143	Electrical engineers
	2144	Electronics and telecommunications engineers
	2145	Mechanical engineers
	2146	Chemical engineers
	2147	Mining engineers, metallurgists and related professionals
	2148	Cartographers and surveyors
	2149	Architects, engineers and related professionals not elsewhere classified
22	Life science and health professionals	
	221	Life science professionals
	2211	Biologists, botanists, zoologists and related professionals
	2212	Pharmacologists, pathologists and related professionals
	2213	Agronomists and related professionals
	222	Health professionals (except nursing)
	2221	Medical doctors
	2222	Dentists
	2223	Veterinarians
	2224	Pharmacists
	2229	Health professionals (except nursing) not elsewhere classified
	223	Nursing and midwifery professionals
	2230	Nursing and midwifery professionals
23	Teaching professionals	
	231	College, university and higher education teaching professionals
	2310	College, university and higher education teaching professionals
	232	Secondary education teaching professionals
	2320	Secondary education teaching professionals
	233	Primary and pre-primary education teaching professionals
	2331	Primary education teaching professionals
	2332	Pre-primary education teaching professionals
	234	Special education teaching professionals
	2340	Special education teaching professionals
	235	Other teaching professionals
	2351	Education methods specialists
	2352	School inspectors
	2359	Other teaching professionals not elsewhere classified
24	Other professionals	
	241	Business professionals
	2411	Accountants
	2412	Personnel and careers professionals
	2419	Business professionals not elsewhere classified
	242	Legal professionals
	2421	Lawyers
	2422	Judges
	2429	Legal professionals not elsewhere classified
	243	Archivists, librarians and related information professionals
	2431	Archivists and curators
	2432	Librarians and related information professionals
	244	Social science and related professionals
	2441	Economists
	2442	Sociologists, anthropologists and related professionals
	2443	Philosophers, historians and political scientists
	2444	Philologists, translators and interpreters
	2445	Psychologists
	2446	Social work professionals
	245	Writers and creative or performing artists
	2451	Authors, journalists and other writers
	2452	Sculptors, painters and related artists
	2453	Composers, musicians and singers
	2454	Choreographers and dancers
	2455	Film, stage and related actors and directors
	246	Religious professionals
	2460	Religious professionals

247	Public service administrative professionals
2470	Public service administrative professionals

MAJOR GROUP 3: TECHNICIANS AND ASSOCIATE PROFESSIONALS

31	Physical and engineering science associate professionals
311	Physical and engineering science technicians
3111	Chemical and physical science technicians
3112	Civil engineering technicians
3113	Electrical engineering technicians
3114	Electronics and telecommunications engineering technicians
3115	Mechanical engineering technicians
3116	Chemical engineering technicians
3117	Mining and metallurgical technicians
3118	Draughtspersons
3119	Physical and engineering science technicians not elsewhere classified
312	Computer associate professionals
3121	Computer assistants
3122	Computer equipment operators
3123	Industrial robot controllers
313	Optical and electronic equipment operators
3131	Photographers and image and sound recording equipment operators
3132	Broadcasting and telecommunications equipment operators
3133	Medical equipment operators
3139	Optical and electronic equipment operators not elsewhere classified
314	Ship and aircraft controllers and technicians
3141	Ships' engineers
3142	Ships' deck officers and pilots
3143	Aircraft pilots and related associate professionals
3144	Air traffic controllers
3145	Air traffic safety technicians
315	Safety and quality inspectors
3151	Building and fire inspectors
3152	Safety, health and quality inspectors
32	Life science and health associate professionals
321	Life science technicians and related associate professional
3211	Life science technicians
3212	Agronomy and forestry technicians
3213	Farming and forestry advisers
322	Health associate professionals (except nursing)
3221	Medical assistants
3222	Hygienists, health and environmental officers
3223	Dieticians and nutritionists
3224	Optometrists and opticians
3225	Dental assistants
3226	Physiotherapists and related associate professionals
3227	Veterinary assistants
3228	Pharmaceutical assistants
3229	Health associate professionals (except nursing) not elsewhere classified
323	Nursing and midwifery associate professionals
3231	Nursing associate professionals
3232	Midwifery associate professionals
33	Teaching associate professionals
331	Primary education teaching associate professionals
3310	Primary education teaching associate professionals
332	Pre-primary education teaching associate professionals
3320	Pre-primary education teaching associate professionals
333	Special education teaching associate professionals
3330	Special education teaching associate professionals
334	Other teaching associate professionals
3340	Other teaching associate professionals

34	Other associate professionals
341	Finance and sales associate professionals
3411	Securities and finance dealers and brokers
3412	Insurance representatives
3413	Estate agents
3414	Travel consultants and organisers
3415	Technical and commercial sales representatives
3416	Buyers
3417	Appraisers, valuers and auctioneers
3419	Finance and sales associate professionals not elsewhere classified
342	Business services agents and trade brokers
3421	Trade brokers
3422	Clearing and forwarding agents
3423	Employment agents and labour contractors
3429	Business services agents and trade brokers not elsewhere classified
343	Administrative associate professionals
3431	Administrative secretaries and related associate professionals
3432	Legal and related business associate professionals
3433	Bookkeepers
3434	Statistical, mathematical and related associate professionals
344	Customs, tax and related government associate professionals
3441	Customs and border inspectors
3442	Government tax and excise officials
3443	Government social benefits officials
3444	Government licensing officials
3449	Customs, tax and related government associate professionals not elsewhere classified
345	Police inspectors and detectives
3450	Police inspectors and detectives
346	Social work associate professionals
3460	Social work associate professionals
347	Artistic, entertainment and sports associate professionals
3471	Decorators and commercial designers
3472	Radio, television and other announcers
3473	Street, night-club and related musicians, singers and dancers
3474	Clowns, magicians, acrobats and related associate professionals
3475	Athletes, sports persons and related associate professionals
348	Religious associate professionals
3480	Religious associate professionals

MAJOR GROUP 4: CLERKS

41	Office clerks
411	Secretaries and keyboard-operating clerks
4111	Stenographers and typists
4112	Word-processor and related operators
4113	Data entry operators
4114	Calculating-machine operators
4115	Secretaries
412	Numerical clerks
4121	Accounting and book-keeping clerks
4122	Statistical and finance clerks
413	Material-recording and transport clerks
4131	Stock clerks
4132	Production clerks
4133	Transport clerks
414	Library, mail and related clerks
4141	Library and filing clerks
4142	Mail carriers and sorting clerks
4143	Coding, proof-reading and related clerks
4144	Scribes and related workers
419	Other office clerks
4190	Other office clerks

42	Customer services clerks
421	Cashiers, tellers and related clerks
4211	Cashiers and ticket clerks
4212	Tellers and other counter clerks
4213	Bookmakers and croupiers
4214	Pawnbrokers and money-lenders
4215	Debt-Collectors and related workers
422	Client information clerks
4221	Travel agency and related clerks
4222	Receptionists and information clerks
4223	Telephone switchboard operators

MAJOR GROUP 5: SERVICE WORKERS AND SHOP AND MARKET SALES WORKERS

51	Personal and protective services workers
511	Travel attendants and related workers
5111	Travel attendants and travel stewards
5112	Transport conductors
5113	Travel guides
512	Housekeeping and restaurant services workers
5121	Housekeepers and related workers
5122	Cooks
5123	Waiters, waitresses and bartenders
513	Personal care and related workers
5131	Child-care workers
5132	Institution-based personal care workers
5133	Home-based personal care workers
5139	Personal care and related workers not elsewhere classified
514	Other personal services workers
5141	Hairdressers, barbers, beauticians and related workers
5142	Companions and valets
5143	Undertakers and embalmers
5149	Other personal services workers not elsewhere classified
516	Protective services workers
5161	Fire-fighters
5162	Police officers
5163	Prison guards
5169	Protective services workers not elsewhere classified
52	Models, salespersons and demonstrators
521	Fashion and other models
5210	Fashion and other models
522	Shop, stall and market salespersons and demonstrators
5220	Shop, stall and market salespersons and demonstrators

MAJOR GROUP 6: SKILLED AGRICULTURAL AND FISHERY WORKERS

61	Skilled agricultural and fishery workers
611	Market gardeners and crop growers
6111	Field crop and vegetable growers
6112	Gardeners, horticultural and nursery growers
612	Animal producers and related workers
6121	Dairy and livestock producers
6122	Poultry producers
6129	Animal producers and related workers not elsewhere classified
613	Crop and animal producers
6130	Crop and animal producers
614	Forestry and related workers
6141	Forestry workers and loggers
6142	Charcoal burners and related workers
615	Fishery workers, hunters and trappers
6151	Aquatic life cultivation workers

6152	Inland and coastal waters fishery workers
6153	Deep-sea fishery workers
6154	Hunters and trappers

MAJOR GROUP 7: CRAFT AND RELATED TRADES WORKERS

71	Extraction and building trades workers
711	Miners, shotfirers, stone cutters and carvers
7111	Miners and quarry workers
7112	Shotfirers and blasters
7113	Stone splitters, cutters and carvers
712	Building frame and related trades workers
7121	Builders
7122	Bricklayers and stonemasons
7123	Concrete placers, concrete finishers and related workers
7124	Carpenters and joiners
7129	Building frame and related trades workers not elsewhere classified
713	Building finishers and related trades workers
7131	Roofers
7132	Floor layers and tile setters
7133	Plasterers
7134	Insulation workers
7135	Glaziers
7136	Plumbers and pipe fitters
7137	Building and related electricians
7139	Building finishers and related trade workers not elsewhere classified
714	Painters, building structure cleaners and related trades workers
7141	Painters and related workers
7143	Building structure cleaners
72	Metal, machinery and related trades workers
721	Metal moulders, welders, sheet-metal workers, structural-metal preparers, and related trades workers
7211	Metal moulders and coremakers
7212	Welders and flame cutters
7213	Sheet-metal workers
7214	Structural-metal preparers and erectors
7215	Riggers and cable splicers
7216	Underwater workers
722	Blacksmiths, tool-makers and related trades workers
7221	Blacksmiths, hammer-smiths and forging-press workers
7222	Tool-makers and related workers
7223	Machine-tool setters and setter-operators
7224	Metal wheel-grinders, polishers and tool sharpeners
723	Machinery mechanics and fitters
7231	Motor vehicle mechanics and fitters
7232	Aircraft engine mechanics and fitters
7233	Agricultural- or industrial-machinery mechanics and fitters
724	Electrical and electronic equipment mechanics and fitters
7241	Electrical mechanics fitters and services
7242	Electronics mechanics, fitters and services
7243	Electronics mechanics and services
7244	Telegraph and telephone installers and services
7245	Electrical line installers, repairers and cable jointers
73	Precision, handicraft, craft printing and related trades workers
731	Precision workers in metal and related materials
7311	Precision-instrument makers and repairers
7312	Musical-instrument makers and tuners
7313	Jewellery and precious-metal workers
732	Potters, glass-makers and related trades workers
7321	Abrasive wheel formers, potters and related workers
7322	Glass-makers, cutters, grinders and finishers
7323	Glass engravers and etchers
7324	Glass, ceramics and related decorative painters
733	Handicraft workers in wood, textile, leather and related materials
7331	Handicraft workers in wood and related materials

	7332	Handicraft workers in textile, leather and related materials
734		Craft printing and related trades workers
	7341	Compositors, typesetters and related workers
	7342	Stereotypes and electrotypers
	7343	Printing engravers and etchers
	7344	Photographic and related workers
	7345	Bookbinders and related workers
	7346	Silk-screen, block and craft textile printers
74		Other craft and related trades workers
	741	Food processing and related trades workers
	7411	Butchers, fishmongers and related food preparers
	7412	Bakers, pastry-cooks and confectionery makers
	7413	Dairy-products workers
	7414	Fruit, vegetable and related preservers
	7415	Food and beverage tasters and graders
	7416	Tobacco preparers and tobacco products makers
	742	Wood treaters, cabinet-makers and related trades workers
	7421	Wood treaters
	7422	Cabinetmakers and related workers
	7423	Woodworking machine setters and setter-operators
	7424	Basketry weavers, brush makers and related workers
	743	Textile, garment and related trades workers
	7431	Fibre preparers
	7432	Weavers, knitters and related workers
	7433	Tailors, dressmakers and hatters
	7434	Furriers and related workers
	7435	Textile, leather and related pattern-makers and cutters
	7436	Sewers, embroiderers and related workers
	7437	Upholsterers and related workers
	744	Pelt, leather and shoemaking trades workers
	7441	Pelt dressers, tanners and fellmongers
	7442	Shoe-makers and related workers

MAJOR GROUP 8: PLANT AND MACHINE OPERATORS AND ASSEMBLERS

81		Stationary plant and related operators
	811	Mining and mineral-processing-plant operators
	8111	Mining plant operators
	8112	Mineral-ore and stone-processing-plant operators
	8113	Well drillers and borers and related workers
	812	Metal-processing plant operators
	8121	Ore and metal furnace operators
	8122	Metal melters, casters and rolling-mill operators
	8123	Metal heat-treating-plant operators
	8124	Metal drawers and extruders
	813	Glass, ceramics and related plant operators
	8131	Glass and ceramics kiln and related machine operators
	8139	Glass, ceramics and related plant operators not elsewhere classified
	814	Wood-processing- and papermaking-plant operators
	8141	Wood-processing-plant operators
	8142	Paper-pulp plant operators
	8143	Papermaking-plant operators
	815	Chemical-processing-plant operators
	8151	Crushing-, grinding- and chemical-mixing-machinery operators
	8152	Chemical-heat-treating-plant operators
	8153	Chemical-filtering- and separating-equipment operators
	8154	Chemical-still and reactor operators (except petroleum and natural gas)
	8155	Petroleum- and natural-gas-refining-plant operators
	8159	Chemical-processing-plant operators not elsewhere classified
	816	Power-production and related plant operators
	8161	Power-production plant operators
	8162	Steam-engine and boiler operators
	8163	Incinerator, water-treatment and related plant operators

817	Industrial robot operators
	8170 Industrial robot operators
82	Machine operators and assemblers
821	Metal- and mineral-products machine operators
	8211 Machine-tool operators
	8212 Cement and other mineral products machine operators
822	Chemical-products machine operators
	8221 Pharmaceutical-and toiletry-products machine operators
	8222 Ammunition- and explosive-products machine operators
	8223 Metal finishing-, plating- and coating-machine operators
	8224 Photographic-products machine operators
	8229 Chemical-products machine operators not elsewhere classified
823	Rubber- and plastic-products machine operators
	8231 Rubber-products machine operators
	8232 Plastic-products machine operators
824	Wood-products machine operators
	8240 Wood-products machine operators
825	Printing-, binding- and paper-products machine operators
	8251 Printing-machine operators
	8252 Book-binding-machine operators
	8253 Paper-products machine operators
826	Textile-, fur- and leather-products machine operators
	8261 Fibre-preparing-, spinning- and winding-machine operators
	8262 Weaving- and knitting-machine operators
	8263 Sewing-machine operators
	8264 Bleaching-, dyeing- and cleaning-machine operators
	8265 Fur- and leather-preparing-machine operators
	8266 Shoemaking- and related machine operators
	8269 Textile-, fur- and leather-products machine operators not elsewhere classified
827	Food and related products machine operators
	8271 Meat- and fish-processing-machine operators
	8272 Dairy-products machine operators
	8273 Grain- and spice-milling-machine operators
	8274 Baked-goods, cereal- and chocolate-products machine operators
	8275 Fruit-, vegetable- and nut-processing-machine operators
	8276 Sugar production machine operators
	8277 Tea-, coffee- and cocoa-processing-machine operators
	8278 Brewers, wine and other beverage machine operators
	8279 Tobacco production machine operators
828	Assemblers
	8281 Mechanical-machinery assemblers
	8282 Electrical-equipment assemblers
	8283 Electronic-equipment assemblers
	8284 Metal-, rubber- and plastic-products assemblers
	8285 Wood and related products assemblers
	8286 Paperboard, textile and related products assemblers
	8287 Composite products assemblers
829	Other machine operators not elsewhere classified
	8290 Other machine operators not elsewhere classified
83	Drivers and mobile plant operators
831	Locomotive engine drivers and related workers
	8311 Locomotive engine drivers
	8312 Railway brakemen, signallers and shunters
832	Motor vehicle drivers
	8321 Motorcycle drivers
	8322 Car, taxi and van drivers
	8323 Bus and tram drivers
	8324 Heavy truck and lorry drivers
833	Agricultural and other mobile plant operators
	8331 Motorised farm and forestry plant operators
	8332 Earth-moving and related plant operators
	8333 Crane, hoist and related plant operators

	8334	Lifting-truck operators
834		Ships' deck crews and related workers
	8340	Ships' deck crews and related workers

MAJOR GROUP 9: ELEMENTARY OCCUPATIONS

91		Sales and services elementary occupations
	911	Street vendors and related workers
		9111 Street vendors
		9113 Door-to-door and telephone salespersons
	912	Shoe cleaning and other street services elementary occupations
		9120 Shoe cleaning and other street services elementary occupations
	913	Domestic and related helpers, cleaners and launderers
		9131 Domestic helpers and cleaners
		9132 Helpers and cleaners in offices, hotels and other establishments
		9133 Hand-launderers and pressers
	914	Building caretakers, window and related cleaners
		9141 Building caretakers
		9142 Vehicle, window and related cleaners
	915	Messengers, porters, doorkeepers and related workers
		9151 Messengers, package and luggage porters and deliverers
		9152 Doorkeepers, watchpersons and related workers
		9153 Vending-machine money Collectors, meter readers and related workers
	916	Garbage Collectors and related labourers
		9161 Garbage Collectors
		9162 Sweepers and related labourers
92		Agricultural, fishery and related labourers
	921	Agricultural, fishery and related labourers
		9211 Farm-hands and labourers
		9212 Forestry labourers
		9213 Fishery, hunting and trapping labourers
93		Labourers in mining, construction, manufacturing and transport
	931	Mining and construction labourers
		9311 Mining and quarrying labourers
		9312 Construction and maintenance labourers: roads, dams, and similar constructions
		9313 Building construction labourers
	932	Manufacturing labourers
		9320 Manufacturing labourers
	933	Transport labourers and freight handlers
		9330 Transport labourers and freight handlers

MAJOR GROUP 0: ARMED FORCES

01		Armed forces
	010	Armed forces
		0100 Armed forces

ANNEX III (b) – International Standard Classification of Occupations 2, 3 and 4 digits (ISCO-08 (com))

Major Group: 1 Managers

- 11 Chief executives, senior officials and legislators
 - 111 Legislators and senior officials
 - 1111 Legislators
 - 1112 Senior government officials
 - 1113 Traditional chiefs and heads of villages
 - 1114 Senior officials of special-interest organizations
 - 112 Managing directors and chief executives
 - 1120 Managing directors and chief executives

- 12 Administrative and commercial managers
 - 121 Business services and administration managers
 - 1211 Finance managers
 - 1212 Human resource managers
 - 1213 Policy and planning managers
 - 1219 Business services and administration managers not elsewhere classified
 - 122 Sales, marketing and development managers
 - 1221 Sales and marketing managers
 - 1222 Advertising and public relations managers
 - 1223 Research and development managers

- 13 Production and specialized services managers
 - 131 Production managers in agriculture, forestry and fisheries
 - 1311 Agricultural and forestry production managers
 - 1312 Aquaculture and fisheries production managers
 - 132 Manufacturing, mining, construction, and distribution managers
 - 1321 Manufacturing managers
 - 1322 Mining managers
 - 1323 Construction managers
 - 1324 Supply, distribution and related managers
 - 133 Information and communications technology service managers
 - 1330 Information and communications technology service managers
 - 134 Professional services managers
 - 1341 Child care services managers
 - 1342 Health service managers
 - 1343 Aged care service managers
 - 1344 Social welfare managers
 - 1345 Education managers
 - 1346 Financial and insurance services branch managers
 - 1349 Professional services managers not elsewhere classified

- 14 Hospitality, retail and other services managers
 - 141 Hotel and restaurant managers
 - 1411 Hotel managers
 - 1412 Restaurant managers
 - 142 Retail and wholesale trade managers
 - 1420 Retail and wholesale trade managers
 - 143 Other services managers
 - 1431 Sports, recreation and cultural centre managers
 - 1439 Services managers not elsewhere classified

Major Group: 2 Professionals

- 21 Science and engineering professionals
 - 211 Physical and earth science professionals
 - 2111 Physicists and astronomers
 - 2112 Meteorologists
 - 2113 Chemists

ISCO-08 (com) – continued

- 2114 Geologists and geophysicists
- 212 Mathematicians, actuaries and statisticians
 - 2120 Mathematicians, actuaries and statisticians
- 213 Life science professionals
 - 2131 Biologists, botanists, zoologists and related professionals
 - 2132 Farming, forestry and fisheries advisers
 - 2133 Environmental protection professionals
- 214 Engineering professionals (excluding electrotechnology)
 - 2141 Industrial and production engineers
 - 2142 Civil engineers
 - 2143 Environmental engineers
 - 2144 Mechanical engineers
 - 2145 Chemical engineers
 - 2146 Mining engineers, metallurgists and related professionals
 - 2149 Engineering professionals not elsewhere classified
- 215 Electrotechnology engineers
 - 2151 Electrical engineers
 - 2152 Electronics engineers
 - 2153 Telecommunications engineers
- 216 Architects, planners, surveyors and designers
 - 2161 Building architects
 - 2162 Landscape architects
 - 2163 Product and garment designers
 - 2164 Town and traffic planners
 - 2165 Cartographers and surveyors
 - 2166 Graphic and multimedia designers

- 22 Health professionals
 - 221 Medical doctors
 - 2211 Generalist medical practitioners
 - 2212 Specialist medical practitioners
 - 222 Nursing and midwifery professionals
 - 2221 Nursing professionals
 - 2222 Midwifery professionals
 - 223 Traditional and complementary medicine professionals
 - 2230 Traditional and complementary medicine professionals
 - 224 Paramedical practitioners
 - 2240 Paramedical practitioners
 - 225 Veterinarians
 - 2250 Veterinarians
 - 226 Other health professionals
 - 2261 Dentists
 - 2262 Pharmacists
 - 2263 Environmental and occupational health and hygiene professionals
 - 2264 Physiotherapists
 - 2265 Dieticians and nutritionists
 - 2266 Audiologists and speech therapists
 - 2267 Optometrists and ophthalmic opticians
 - 2269 Health professionals not elsewhere classified

- 23 Teaching professionals
 - 231 University and higher education teachers
 - 2310 University and higher education teachers
 - 232 Vocational education teachers
 - 2320 Vocational education teachers
 - 233 Secondary education teachers
 - 2330 Secondary education teachers
 - 234 Primary school and early childhood teachers
 - 2341 Primary school teachers

ISCO-08 (com) – continued

- 2342 Early childhood educators
- 235 Other teaching professionals
 - 2351 Education methods specialists
 - 2352 Special needs teachers
 - 2353 Other language teachers
 - 2354 Other music teachers
 - 2355 Other arts teachers
 - 2356 Information technology trainers
 - 2359 Teaching professionals not elsewhere classified
- 24 Business and administration professionals
 - 241 Finance professionals
 - 2411 Accountants
 - 2412 Financial and investment advisers
 - 2413 Financial analysts
 - 242 Administration professionals
 - 2421 Management and organization analysts
 - 2422 Policy administration professionals
 - 2423 Personnel and careers professionals
 - 2424 Training and staff development professionals
 - 243 Sales, marketing and public relations professionals
 - 2431 Advertising and marketing professionals
 - 2432 Public relations professionals
 - 2433 Technical and medical sales professionals (excluding ICT)
 - 2434 Information and communications technology sales professionals
- 25 Information and communications technology professionals
 - 251 Software and applications developers and analysts
 - 2511 Systems analysts
 - 2512 Software developers
 - 2513 Web and multimedia developers
 - 2514 Applications programmers
 - 2519 Software and applications developers and analysts not elsewhere classified
 - 252 Database and network professionals
 - 2521 Database designers and administrators
 - 2522 Systems administrators
 - 2523 Computer network professionals
 - 2529 Database and network professionals not elsewhere classified
- 26 Legal, social and cultural professionals
 - 261 Legal professionals
 - 2611 Lawyers
 - 2612 Judges
 - 2619 Legal professionals not elsewhere classified
 - 262 Librarians, archivists and curators
 - 2621 Archivists and curators
 - 2622 Librarians and related information professionals
 - 263 Social and religious professionals
 - 2631 Economists
 - 2632 Sociologists, anthropologists and related professionals
 - 2633 Philosophers, historians and political scientists
 - 2634 Psychologists
 - 2635 Social work and counselling professionals
 - 2636 Religious professionals
 - 264 Authors, journalists and linguists
 - 2641 Authors and related writers
 - 2642 Journalists
 - 2643 Translators, interpreters and other linguists
 - 265 Creative and performing artists

ISCO-08 (com) – continued

- 2651 Visual artists
- 2652 Musicians, singers and composers
- 2653 Dancers and choreographers
- 2654 Film, stage and related directors and producers
- 2655 Actors
- 2656 Announcers on radio, television and other media
- 2659 Creative and performing artists not elsewhere classified

Major Group: 3 Technicians and associate professionals

- 31 Science and engineering associate professionals
 - 311 Physical and engineering science technicians
 - 3111 Chemical and physical science technicians
 - 3112 Civil engineering technicians
 - 3113 Electrical engineering technicians
 - 3114 Electronics engineering technicians
 - 3115 Mechanical engineering technicians
 - 3116 Chemical engineering technicians
 - 3117 Mining and metallurgical technicians
 - 3118 Draughtspersons
 - 3119 Physical and engineering science technicians not elsewhere classified
 - 312 Mining, manufacturing and construction supervisors
 - 3121 Mining supervisors
 - 3122 Manufacturing supervisors
 - 3123 Construction supervisors
 - 313 Process control technicians
 - 3131 Power production plant operators
 - 3132 Incinerator and water treatment plant operators
 - 3133 Chemical processing plant controllers
 - 3134 Petroleum and natural gas refining plant operators
 - 3135 Metal production process controllers
 - 3139 Process control technicians not elsewhere classified
 - 314 Life science technicians and related associate professionals
 - 3141 Life science technicians (excluding medical)
 - 3142 Agricultural technicians
 - 3143 Forestry technicians
 - 315 Ship and aircraft controllers and technicians
 - 3151 Ships' engineers
 - 3152 Ships' deck officers and pilots
 - 3153 Aircraft pilots and related associate professionals
 - 3154 Air traffic controllers
 - 3155 Air traffic safety electronics technicians
- 32 Health associate professionals
 - 321 Medical and pharmaceutical technicians
 - 3211 Medical imaging and therapeutic equipment technicians
 - 3212 Medical and pathology laboratory technicians
 - 3213 Pharmaceutical technicians and assistants
 - 3214 Medical and dental prosthetic technicians
 - 322 Nursing and midwifery associate professionals
 - 3221 Nursing associate professionals
 - 3222 Midwifery associate professionals
 - 323 Traditional and complementary medicine associate professionals
 - 3230 Traditional and complementary medicine associate professionals
 - 324 Veterinary technicians and assistants
 - 3240 Veterinary technicians and assistants
 - 325 Other health associate professionals
 - 3251 Dental assistants and therapists
 - 3252 Medical records and health information technicians

ISCO-08 (com) – continued

- 3253 Community health workers
- 3254 Dispensing opticians
- 3255 Physiotherapy technicians and assistants
- 3256 Medical assistants
- 3257 Environmental and occupational health inspectors and associates
- 3258 Ambulance workers
- 3259 Health associate professionals not elsewhere classified

33 Business and administration associate professionals

- 331 Financial and mathematical associate professionals
 - 3311 Securities and finance dealers and brokers
 - 3312 Credit and loans officers
 - 3313 Accounting associate professionals
 - 3314 Statistical, mathematical and related associate professionals
 - 3315 Valuers and loss assessors
- 332 Sales and purchasing agents and brokers
 - 3321 Insurance representatives
 - 3322 Commercial sales representatives
 - 3323 Buyers
 - 3324 Trade brokers
- 333 Business services agents
 - 3331 Clearing and forwarding agents
 - 3332 Conference and event planners
 - 3333 Employment agents and contractors
 - 3334 Real estate agents and property managers
 - 3339 Business services agents not elsewhere classified
- 334 Administrative and specialised secretaries
 - 3341 Office supervisors
 - 3342 Legal secretaries
 - 3343 Administrative and executive secretaries
 - 3344 Medical secretaries
- 335 Regulatory government associate professionals
 - 3351 Customs and border inspectors
 - 3352 Government tax and excise officials
 - 3353 Government social benefits officials
 - 3354 Government licensing officials
 - 3355 Police inspectors and detectives
 - 3359 Government regulatory associate professionals not elsewhere classified

34 Legal, social, cultural and related associate professionals

- 341 Legal, social and religious associate professionals
 - 3411 Legal and related associate professionals
 - 3412 Social work associate professionals
 - 3413 Religious associate professionals
- 342 Sports and fitness workers
 - 3421 Athletes and sports players
 - 3422 Sports coaches, instructors and officials
 - 3423 Fitness and recreation instructors and program leaders
- 343 Artistic, cultural and culinary associate professionals
 - 3431 Photographers
 - 3432 Interior designers and decorators
 - 3433 Gallery, museum and library technicians
 - 3434 Chefs
 - 3435 Artistic and cultural associate professionals not elsewhere classified

35 Information and communications technicians

- 351 Information and communications technology operations and user support technicians
 - 3511 Information and communications technology operations technicians
 - 3512 Information and communications technology user support technicians

ISCO-08 (com) – continued

- 3513 Computer network and systems technicians
- 3514 Web technicians
- 352 Telecommunications and broadcasting technicians
 - 3521 Broadcasting and audio-visual technicians
 - 3522 Telecommunications engineering technicians

Major Group: 4 Clerical support workers

- 41 General and keyboard clerks
 - 411 General office clerks
 - 4110 General office clerks
 - 412 Secretaries (general)
 - 4120 Secretaries (general)
 - 413 Keyboard operators
 - 4131 Typists and word processing operators
 - 4132 Data entry clerks
- 42 Customer services clerks
 - 421 Tellers, money collectors and related clerks
 - 4211 Bank tellers and related clerks
 - 4212 Bookmakers, croupiers and related gaming workers
 - 4213 Pawnbrokers and money-lenders
 - 4214 Debt-collectors and related workers
 - 422 Client information workers
 - 4221 Travel consultants and clerks
 - 4222 Contact centre information clerks
 - 4223 Telephone switchboard operators
 - 4224 Hotel receptionists
 - 4225 Enquiry clerks
 - 4226 Receptionists (general)
 - 4227 Survey and market research interviewers
 - 4229 Client information workers not elsewhere classified
- 43 Numerical and material recording clerks
 - 431 Numerical clerks
 - 4311 Accounting and bookkeeping clerks
 - 4312 Statistical, finance and insurance clerks
 - 4313 Payroll clerks
 - 432 Material-recording and transport clerks
 - 4321 Stock clerks
 - 4322 Production clerks
 - 4323 Transport clerks
- 44 Other clerical support workers
 - 441 Other clerical support workers
 - 4411 Library clerks
 - 4412 Mail carriers and sorting clerks
 - 4413 Coding, proof-reading and related clerks
 - 4414 Scribes and related workers
 - 4415 Filing and copying clerks
 - 4416 Personnel clerks
 - 4419 Clerical support workers not elsewhere classified

Major Group: 5 Service and sales workers

- 51 Personal service workers
 - 511 Travel attendants, conductors and guides
 - 5111 Travel attendants and travel stewards
 - 5112 Transport conductors

ISCO-08 (com) – continued

- 5113 Travel guides
- 512 Cooks
 - 5120 Cooks
- 513 Waiters and bartenders
 - 5131 Waiters
 - 5132 Bartenders
- 514 Hairdressers, beauticians and related workers
 - 5141 Hairdressers
 - 5142 Beauticians and related workers
- 515 Building and housekeeping supervisors
 - 5151 Cleaning and housekeeping supervisors in offices, hotels and other establishments
 - 5152 Domestic housekeepers
 - 5153 Building caretakers
- 516 Other personal services workers
 - 5161 Astrologers, fortune-tellers and related workers
 - 5162 Companions and valets
 - 5163 Undertakers and embalmers
 - 5164 Pet groomers and animal care workers
 - 5165 Driving instructors
 - 5169 Personal services workers not elsewhere classified
- 52 Sales workers
 - 521 Street and market salespersons
 - 5211 Stall and market salespersons
 - 5212 Street food salespersons
 - 522 Shop salespersons
 - 5221 Shopkeepers
 - 5222 Shop supervisors
 - 5223 Shop sales assistants
 - 523 Cashiers and ticket clerks
 - 5230 Cashiers and ticket clerks
 - 524 Other sales workers
 - 5241 Fashion and other models
 - 5242 Sales demonstrators
 - 5243 Door to door salespersons
 - 5244 Contact centre salespersons
 - 5245 Service station attendants
 - 5246 Food service counter attendants
 - 5249 Sales workers not elsewhere classified
- 53 Personal care workers
 - 531 Child care workers and teachers' aides
 - 5311 Child care workers
 - 5312 Teachers' aides
 - 532 Personal care workers in health services
 - 5321 Health care assistants
 - 5322 Home-based personal care workers
 - 5329 Personal care workers in health services not elsewhere classified
- 54 Protective services workers
 - 541 Protective services workers
 - 5411 Fire fighters
 - 5412 Police officers
 - 5413 Prison guards
 - 5414 Security guards
 - 5419 Protective services workers not elsewhere classified

ISCO-08 (com) – continued

Major Group: 6 Skilled agricultural, forestry and fishery workers

- 61 Market-oriented skilled agricultural workers
 - 611 Market gardeners and crop growers
 - 6111 Field crop and vegetable growers
 - 6112 Tree and shrub crop growers
 - 6113 Gardeners, horticultural and nursery growers
 - 6114 Mixed crop growers
 - 612 Animal producers
 - 6121 Livestock and dairy producers
 - 6122 Poultry producers
 - 6123 Apiarists and sericulturists
 - 6129 Animal producers not elsewhere classified
 - 613 Mixed crop and animal producers
 - 6130 Mixed crop and animal producers

- 62 Market-oriented skilled forestry, fishery and hunting workers
 - 621 Forestry and related workers
 - 6210 Forestry and related workers
 - 622 Fishery workers, hunters and trappers
 - 6221 Aquaculture workers
 - 6222 Inland and coastal waters fishery workers
 - 6223 Deep-sea fishery workers
 - 6224 Hunters and trappers

- 63 Subsistence farmers, fishers, hunters and gatherers
 - 631 Subsistence crop farmers
 - 6310 Subsistence crop farmers
 - 632 Subsistence livestock farmers
 - 6320 Subsistence livestock farmers
 - 633 Subsistence mixed crop and livestock farmers
 - 6330 Subsistence mixed crop and livestock farmers
 - 634 Subsistence fishers, hunters, trappers and gatherers
 - 6340 Subsistence fishers, hunters, trappers and gatherers

Major Group: 7 Craft and related trades workers

- 71 Building and related trades workers, excluding electricians
 - 711 Building frame and related trades workers
 - 7111 House builders
 - 7112 Bricklayers and related workers
 - 7113 Stonemasons, stone cutters, splitters and carvers
 - 7114 Concrete placers, concrete finishers and related workers
 - 7115 Carpenters and joiners
 - 7119 Building frame and related trades workers not elsewhere classified
 - 712 Building finishers and related trades workers
 - 7121 Roofers
 - 7122 Floor layers and tile setters
 - 7123 Plasterers
 - 7124 Insulation workers
 - 7125 Glaziers
 - 7126 Plumbers and pipe fitters
 - 7127 Air conditioning and refrigeration mechanics
 - 713 Painters, building structure cleaners and related trades workers
 - 7131 Painters and related workers
 - 7132 Spray painters and varnishers
 - 7133 Building structure cleaners

ISCO-08 (com) – continued

72 Metal, machinery and related trades workers

721 Sheet and structural metal workers, moulders and welders, and related workers

7211 Metal moulders and coremakers

7212 Welders and flame cutters

7213 Sheet-metal workers

7214 Structural-metal preparers and erectors

7215 Riggers and cable splicers

722 Blacksmiths, toolmakers and related trades workers

7221 Blacksmiths, hammersmiths and forging press workers

7222 Toolmakers and related workers

7223 Metal working machine tool setters and operators

7224 Metal polishers, wheel grinders and tool sharpeners

723 Machinery mechanics and repairers

7231 Motor vehicle mechanics and repairers

7232 Aircraft engine mechanics and repairers

7233 Agricultural and industrial machinery mechanics and repairers

7234 Bicycle and related repairers

73 Handicraft and printing workers

731 Handicraft workers

7311 Precision-instrument makers and repairers

7312 Musical instrument makers and tuners

7313 Jewellery and precious metal workers

7314 Potters and related workers

7315 Glass makers, cutters, grinders and finishers

7316 Sign writers, decorative painters, engravers and etchers

7317 Handicraft workers in wood, basketry and related materials

7318 Handicraft workers in textile, leather and related materials

7319 Handicraft workers not elsewhere classified

732 Printing trades workers

7321 Pre-press technicians

7322 Printers

7323 Print finishing and binding workers

74 Electrical and electronic trades workers

741 Electrical equipment installers and repairers

7411 Building and related electricians

7412 Electrical mechanics and fitters

7413 Electrical line installers and repairers

742 Electronics and telecommunications installers and repairers

7421 Electronics mechanics and servicers

7422 Information and communications technology installers and servicers

75 Food processing, wood working, garment and other craft and related trades workers

751 Food processing and related trades workers

7511 Butchers, fishmongers and related food preparers

7512 Bakers, pastry-cooks and confectionery makers

7513 Dairy-products makers

7514 Fruit, vegetable and related preservers

7515 Food and beverage tasters and graders

7516 Tobacco preparers and tobacco products makers

752 Wood treaters, cabinet-makers and related trades workers

7521 Wood treaters

7522 Cabinet-makers and related workers

7523 Woodworking-machine tool setters and operators

753 Garment and related trades workers

7531 Tailors, dressmakers, furriers and hatters

7532 Garment and related pattern-makers and cutters

7533 Sewing, embroidery and related workers

ISCO-08 (com) – continued

- 7534 Upholsterers and related workers
- 7535 Pelt dressers, tanners and fellmongers
- 7536 Shoemakers and related workers
- 754 Other craft and related workers
 - 7541 Underwater divers
 - 7542 Shotfirers and blasters
 - 7543 Product graders and testers (except foods and beverages)
 - 7544 Fumigators and other pest and weed controllers
 - 7549 Craft and related workers not elsewhere classified

Major Group: 8 Plant and machine operators, and assemblers

- 81 Stationary plant and machine operators
 - 811 Mining and mineral processing plant operators
 - 8111 Miners and quarriers
 - 8112 Mineral and stone processing plant operators
 - 8113 Well drillers and borers and related workers
 - 8114 Cement, stone and other mineral products machine operators
 - 812 Metal processing and finishing plant operators
 - 8121 Metal processing plant operators
 - 8122 Metal finishing, plating and coating machine operators
 - 813 Chemical and photographic products plant and machine operators
 - 8131 Chemical products plant and machine operators
 - 8132 Photographic products machine operators
 - 814 Rubber, plastic and paper products machine operators
 - 8141 Rubber products machine operators
 - 8142 Plastic products machine operators
 - 8143 Paper products machine operators
 - 815 Textile, fur and leather products machine operators
 - 8151 Fibre preparing, spinning and winding machine operators
 - 8152 Weaving and knitting machine operators
 - 8153 Sewing machine operators
 - 8154 Bleaching, dyeing and fabric cleaning machine operators
 - 8155 Fur and leather preparing machine operators
 - 8156 Shoemaking and related machine operators
 - 8157 Laundry machine operators
 - 8159 Textile, fur and leather products machine operators not elsewhere classified
 - 816 Food and related products machine operators
 - 8160 Food and related products machine operators
 - 817 Wood processing and papermaking plant operators
 - 8171 Pulp and papermaking plant operators
 - 8172 Wood processing plant operators
 - 818 Other stationary plant and machine operators
 - 8181 Glass and ceramics plant operators
 - 8182 Steam engine and boiler operators
 - 8183 Packing, bottling and labelling machine operators
 - 8189 Stationary plant and machine operators not elsewhere classified
- 82 Assemblers
 - 821 Assemblers
 - 8211 Mechanical machinery assemblers
 - 8212 Electrical and electronic equipment assemblers
 - 8219 Assemblers not elsewhere classified
- 83 Drivers and mobile plant operators
 - 831 Locomotive engine drivers and related workers
 - 8311 Locomotive engine drivers
 - 8312 Railway brake, signal and switch operators

ISCO-08 (com) – continued

- 832 Car, van and motorcycle drivers
 - 8321 Motorcycle drivers
 - 8322 Car, taxi and van drivers
- 833 Heavy truck and bus drivers
 - 8331 Bus and tram drivers
 - 8332 Heavy truck and lorry drivers
- 834 Mobile plant operators
 - 8341 Mobile farm and forestry plant operators
 - 8342 Earthmoving and related plant operators
 - 8343 Crane, hoist and related plant operators
 - 8344 Lifting truck operators
- 835 Ships' deck crews and related workers
 - 8350 Ships' deck crews and related workers

Major Group: 9 Elementary occupations

91 Cleaners and helpers

- 911 Domestic, hotel and office cleaners and helpers
 - 9111 Domestic cleaners and helpers
 - 9112 Cleaners and helpers in offices, hotels and other establishments
- 912 Vehicle, window, laundry and other hand cleaning workers
 - 9121 Hand launderers and pressers
 - 9122 Vehicle cleaners
 - 9123 Window cleaners
 - 9129 Other cleaning workers

92 Agricultural, forestry and fishery labourers

- 921 Agricultural, forestry and fishery labourers
 - 9211 Crop farm labourers
 - 9212 Livestock farm labourers
 - 9213 Mixed crop and livestock farm labourers
 - 9214 Garden and horticultural labourers
 - 9215 Forestry labourers
 - 9216 Fishery and aquaculture labourers

93 Labourers in mining, construction, manufacturing and transport

- 931 Mining and construction labourers
 - 9311 Mining and quarrying labourers
 - 9312 Civil engineering labourers
 - 9313 Building construction labourers
- 932 Manufacturing labourers
 - 9321 Hand packers
 - 9329 Manufacturing labourers not elsewhere classified
- 933 Transport and storage labourers
 - 9331 Hand and pedal vehicle drivers
 - 9332 Drivers of animal-drawn vehicles and machinery
 - 9333 Freight handlers
 - 9334 Shelf fillers

94 Food preparation assistants

- 941 Food preparation assistants
 - 9411 Fast food preparers
 - 9412 Kitchen helpers

95 Street and related sales and service workers

- 951 Street and related service workers
 - 9510 Street and related service workers
- 952 Street vendors (excluding food)
 - 9520 Street vendors (excluding food)

ISCO-08 (com) – continued

- 96 Refuse workers and other elementary workers
 - 961 Refuse workers
 - 9611 Garbage and recycling collectors
 - 9612 Refuse sorters
 - 9613 Sweepers and related labourers
 - 962 Other elementary workers
 - 9621 Messengers, package deliverers and luggage porters
 - 9622 Odd job persons
 - 9623 Meter readers and vending-machine collectors
 - 9624 Water and firewood collectors
 - 9629 Elementary workers not elsewhere classified

Major Group: 0 Armed forces occupations

- 01 Commissioned armed forces officers
 - 011 Commissioned armed forces officers
 - 0110 Commissioned armed forces officers
- 02 Non-commissioned armed forces officers
 - 021 Non-commissioned armed forces officers
 - 0210 Non-commissioned armed forces officers
- 03 Armed forces occupations, other ranks
 - 031 Armed forces occupations, other ranks
 - 0310 Armed forces occupations, other ranks

Annex III (c) – SOC2000 to ISCO-88 (COM) look-up

SOC2000		ISCO88	
1111	Senior officials in national gov	1110	Legislators and senior government officials
1112	Directors & chief execs of maj orgs	1210	Directors and chief executives
1113	Senior officials in local gov	1110	Legislators and senior government officials
1114	Sen. officials spec interest orgs	1140	Senior officials of special-interest organisations
1121	Prod. works & maintenance managers	1222	Production and operations managers in manufacturing
		1312	Managers of small enterprises in manufacturing
1122	Managers in construction	1223	Production and operations managers in construction
		1313	Managers of small enterprises in construction
1123	Managers in mining and energy	1222	Production and operations managers in manufacturing
1131	Financial managers & chartered secs	1231	Finance and administration managers
1132	Marketing and sales managers	1233	Sales and marketing managers
1133	Purchasing managers	1235	Supply and distribution managers
1134	Advertising & public rel managers	1234	Advertising and public relations managers
1135	Pers training & ind rel mngers	1232	Personnel and industrial relations managers
1136	Info & communication technol mngers	1236	Computing services managers
1137	Research and development managers	1237	Research and development managers
1141	Quality assurance managers	1239	Other specialist managers not elsewhere classified
1142	Customer care managers	1239	Other specialist managers not elsewhere classified
1151	Financial institution managers	1227	Production and operations managers in business services enterprises
		1317	Managers of small enterprises of business services enterprises
1152	Office managers	1231	Finance and administration managers
1161	Transport and distribution managers	1226	Production and operations managers in transport, storage, comms
		1316	Managers of small enterprises in transport, storage and comms
1162	Storage and warehouse managers	1226	Production and operations managers in transport, storage, comms
		1316	Managers of small enterprises in transport, storage and comms
1163	Retail and wholesale managers	1224	Production and operations managers in wholesale and retail trade
		1314	Managers of small enterprises in wholesale and retail trade
1171	Officers in armed forces	0100	Armed Forces
1172	Police officers (inspectrs & above)	3450	Police inspectors and detectives
1173	Snr officers fire, amb, prson et al	1229	Production and operations managers not elsewhere classified
1174	Security managers	1239	Other specialist managers not elsewhere classified
1181	Hospital and health service mngers	1229	Production and operations managers not elsewhere classified
		1229	Production and operations managers not elsewhere classified
1182	Pharmacy managers	1319	Managers of small enterprises not elsewhere classified
		1229	Production and operations managers not elsewhere classified
1183	Healthcare practice managers	1319	Managers of small enterprises not elsewhere classified
1184	Social services managers	1229	Production and operations managers not elsewhere classified
1185	Residential and day care managers	1228	Production and operations managers in personal care, cleaning etc
		1318	Managers of small enterprises in personal care, cleaning etc
1211	Farm managers	1221	Production, operations managers in agriculture, hunting, forestry, fishing
		1311	Managers of small enterprises in agriculture, hunting, forestry, fishing
1212	Natural environ & cons managers	1221	Production, operations managers in agriculture, hunting, forestry, fishing
		1311	Managers of small enterprises in agriculture, hunting, forestry, fishing
1219	Mngr anml hsbndry, frst, fish nec.	1221	Production, operations managers in agriculture, hunting, forestry, fishing
		1311	Managers of small enterprises in agriculture, hunting, forestry, fishing
1221	Hotel and accommodation managers	1225	Production and operations managers in restaurants and hotels
		1315	Managers of small enterprises of restaurants and hotels
1222	Conference and exhibition managers	1227	Production and operations managers in business services enterprises
		1317	Managers of small enterprises of business services enterprises
1223	Restaurant and catering managers	1225	Production and operations managers in restaurants and hotels
		1315	Managers of small enterprises of restaurants and hotels
1224	Publicans & managrs licensed prmises	1225	Production and operations managers in restaurants and hotels
		1315	Managers of small enterprises of restaurants and hotels
1225	Leisure and sports managers	1229	Production and operations managers not elsewhere classified
		1319	Managers of small enterprises not elsewhere classified
1226	Travel agency managers	1226	Production and operations managers in transport, storage and comms
		1316	Managers of small enterprises in transport, storage and comms

SOC2000		ISCO88	
1231	Property, housing and land managers	1227	Production and operations managers in business services enterprises
		1317	Managers of small enterprises of business services enterprises
1232	Garage managers and proprietors	1224	Production and operations managers in wholesale and retail trade
		1314	Managers of small enterprises in wholesale and retail trade
1233	Hairdrrs & beauty slon mngr & props	1228	Production and operations managers in personal care, cleaning etc
		1318	Managers of small enterprises in personal care, cleaning etc
1234	Shopkprsr, wholesale & retail deals	1314	Managers of small enterprises in wholesale and retail trade
1235	Recyc and refuse disposal managers	1229	Production and operations managers not elsewhere classified
		1319	Managers of small enterprises not elsewhere classified
1239	Mngers and prop. In other srvcs NEC	1229	Production and operations managers not elsewhere classified
		1319	Managers of small enterprises not elsewhere classified
2111	Chemists	2113	Chemists
2112	Bio scientists and biochemists	2211	Biologists, botanists, zoologists and related professionals
2113	Physts, geologists & meteorologists	2110	Physicists, chemists and related professionals
2121	Civil engineers	2142	Civil engineers
2122	Mechanical engineers	2145	Mechanical engineers
2123	Electrical engineers	2143	Electrical engineers
2124	Electronics engineers	2144	Electronics and telecommunications engineers
2125	Chemical engineers	2146	Chemical engineers
2126	Design and development engineers	2149	Architects, engineers and related professionals NEC
2127	Production and process engineers	2149	Architects, engineers and related professionals NEC
2128	Planning and qlty control engineers	2149	Architects, engineers and related professionals NEC
2129	Engineering professionals n.e.c.	2149	Architects, engineers and related professionals NEC
2131	IT strategy and planning prfsnals	2130	Computing professionals
2132	Software professionals	2130	Computing professionals
2211	Medical practitioners	2221	Medical doctors
2212	Psychologists	2445	Psychologists
2213	Pharmacists & pharmacologists	2224	Pharmacists
2214	Ophthalmic opticians	2229	Health professionals (except nursing) NEC
2215	Dental practitioners	2222	Dentists
2216	Veterinarians	2223	Veterinarians
2311	Higher educ teaching prfsnals	2310	College, university and higher education teaching professionals
2312	Further educ teaching prfsnals	2310	College, university and higher education teaching professionals
2313	educ officers,school inspectrs	2352	School inspectors
2314	Secondary eductn teaching prfsnals	2320	Secondary education teaching professionals
2315	Prim & nurs eductn teaching profs	2330	Primary and pre-primary education teaching professionals
2316	Spec needs educ teaching profs	2340	Special education teaching professionals
2317	Registrs & sen admins ed establish	2359	Other teaching professionals NEC
2319	Teaching professionals n.e.c.	2359	Other teaching professionals NEC
2321	Scientific researchers	2110	Physicists, chemists and related professionals
2322	Social science researchers	2440	Social science and related professionals
2329	Researchers n.e.c.	2310	College, university and higher education teaching professionals
2411	Solic & lawyers, judges & coroners	2420	Legal professionals
2419	Legal professionals n.e.c.	2429	Legal professionals NEC
2421	Chartered and certified accountants	2411	Accountants
2422	Management accountants	2411	Accountants
2423	Mngmnt cons, actuar, econs & statn	2419	Business professionals NEC
2431	Architects	2141	Architects, town and traffic planners
2432	Town planners	2141	Architects, town and traffic planners
2433	Quantity surveyors	2148	Cartographers and surveyors
2434	Chartrd surveyors (not qntity surv)	2148	Cartographers and surveyors
2441	Public service administrative profs	2470	Public service administrative professionals
2442	Social workers	2446	Social work professionals
2443	Probation officers	2446	Social work professionals
2444	Clergy	2460	Religious professionals
2451	Librarians	2432	Librarians and related information professionals
2452	Archivists and curators	2431	Archivists and curators
3111	Laboratory technicians	3111	Chemical and physical science technicians
3112	Electrical & electronic technicians	3114	Electronics and telecommunications engineering technicians

SOC2000		ISCO88	
3113	Engineering technicians	3110	Physical and engineering science technicians
3114	Build & civil eng technicians	3112	Civil engineering technicians
3115	Quality assurance technicians	3119	Physical and engineering science technicians NEC
3119	Science & eng technicians n.e.c.	3119	Physical and engineering science technicians NEC
3121	Archit technols & town plan technics	3119	Physical and engineering science technicians NEC
3122	Draughtspersons	3118	Draughtspersons
3123	Building inspectors	3151	Building and fire inspectors
3131	IT operations technicians	3120	Computer associate professionals
3132	IT user support technicians	3120	Computer associate professionals
3211	Nurses	3231	Nursing associate professionals
3212	Midwives	3232	Midwifery associate professionals
3213	Paramedics	3221	Medical assistants
3214	Medical radiographers	3133	Medical equipment operators
3215	Chiropodists	3226	Physiotherapists and related associate professionals
3216	Dispensing opticians	3224	Optometrists and opticians
3217	Pharmaceutical dispensers	3228	Pharmaceutical assistants
3218	Medical and dental technicians	3220	Health associate professionals (except nursing)
3221	Physiotherapists	3226	Physiotherapists and related associate professionals
3222	Occupational therapists	3226	Physiotherapists and related associate professionals
3223	Speech and language therapists	3226	Physiotherapists and related associate professionals
3229	Therapists n.e.c.	3226	Physiotherapists and related associate professionals
3231	Youth and community workers	3460	Social work associate professionals
3232	Housing and welfare officers	3460	Social work associate professionals
3311	NCOs and other ranks	0100	Armed Forces
3312	Police ofcfrs (sergeant and below)	5162	Police officers
3313	Fire serv off (leading off & below)	5161	Fire-fighters
3314	Prison serv off (below princ off)	5163	Prison guards
3319	Protective servcs assoc prfsnls NEC	5169	Protective services workers NEC
3411	Artists	2452	Sculptors, painters and related artists
3412	Authors, writers	2451	Authors, journalists and other writers
3413	Actors, entertainers	3470	Artistic, entertainment and sports associate professionals
3414	Dancers and choreographers	3473	Street, night-club and related musicians, singers and dancers
3415	Musicians	3473	Street, night-club and related musicians, singers and dancers
3416	Arts ofcfrs, prdcers and directors	2455	Film, stage and related actors and directors
3421	Graphic designers	3471	Decorators and commercial designers
3422	Product, clothing & related dsgners	3471	Decorators and commercial designers
3431	Journalists, newsprr & period eds	2451	Authors, journalists and other writers
3432	Broadcasting associate prfssnals	3472	Radio, television and other announcers
3433	Public relations officers	3419	Finance and sales associate professionals NEC
3434	Photo. & audio-visual equip operats	3131	Photographers and image and sound recording equipment operators
3441	Sports players	3475	Athletes, sports persons and related associate professionals
3442	Sports coaches, instruc & officials	3475	Athletes, sports persons and related associate professionals
3443	Fitness instructors	3475	Athletes, sports persons and related associate professionals
3449	Sports and fitness occupations nec.	3475	Athletes, sports persons and related associate professionals
3511	Air traffic controllers	3144	Air traffic controllers
3512	Aircraft pilots and flight engins	3143	Aircraft pilots and related associate professionals
3513	Ship and hovercraft officers	3142	Ships' deck officers and pilots
3514	Train drivers	8311	Locomotive engine drivers
3520	Legal associate professionals	3432	Legal and related business associate professionals
3531	Estimators, valuers and assessors	3417	Appraisers, valuers and auctioneers
3532	Brokers	3411	Securities and finance dealers and brokers
3533	Insurance underwriters	3412	Insurance representatives
3534	Fin. & invest. analyst & advisers	3419	Finance and sales associate professionals NEC
3535	Taxation experts	3442	Government tax and excise officials
3536	Importers, exporters	3422	Clearing and forwarding agents
3537	Financial and accounting techs	3433	Bookkeepers
3539	Business & related assoc profs nec.	3419	Finance and sales associate professionals NEC
3541	Buyers and purchasing officers	3416	Buyers
3542	Sales representatives	3415	Technical and commercial sales representatives

SOC2000		ISCO88	
3542	Sales representatives	3415	Technical and commercial sales representatives
3543	Marketing associate professionals	3419	Finance and sales associate professionals NEC
3544	Estate agents, auctioneers	3413	Estate agents
3551	Conservat & environ protection offs	3210	Life science technicians and related associate professionals
3552	Countryside and park rangers	3210	Life science technicians and related associate professionals
3561	Public serv associate professionals	3449	Customs, tax and related government associate professionals NEC
3562	Personnel & ind relations offs	2412	Personnel and careers professionals
3563	Vocatn & indust trainrs & instrctrs	3340	Other teaching associate professionals
3564	Car. advis & voction guidnce spcils	2412	Personnel and careers professionals
3565	Inspcts fact, utils & trdng stndrds	3152	Safety, health and quality inspectors
3566	Statutory examiners	3152	Safety, health and quality inspectors
3567	Occupl hygnists & health sfty offs	3152	Safety, health and quality inspectors
3568	Environmental health officers	3152	Safety, health and quality inspectors
4111	Civil Service executive officers	4190	Other office clerks
4112	Civil Serv admin offcrs and assists	4190	Other office clerks
4113	Local gov clerical offs & assists	4190	Other office clerks
4114	Officers non-gov organisations	4190	Other office clerks
4121	Credit controllers	4120	Numerical clerks
4122	Accnts wages clerk, bookkeeper	4120	Numerical clerks
4123	Counter clerks	4210	Cashiers, tellers and related clerks
4131	Filing & othr recrds assists & clrks	4141	Library and filing clerks
4132	Pensions and insurance clrks	4190	Other office clerks
4133	Stock control clerks	4131	Stock clerks
4134	Transport and distribution clerks	4133	Transport clerks
4135	Library assistants & clerks	4141	Library and filing clerks
4136	Database assistants & clerks	4113	Data entry operators
4137	Market research interviewers	4190	Other office clerks
4141	Telephonists	4223	Telephone switchboard operators
4142	Communication operators	4223	Telephone switchboard operators
4150	General office assistants or clerks	4190	Other office clerks
4211	Medical secretaries	4115	Secretaries
4212	Legal secretaries	4115	Secretaries
4213	School secretaries	4115	Secretaries
4214	Company secretaries	4115	Secretaries
4215	Personal assists & othr secretaries	4115	Secretaries
4216	Receptionists	4222	Receptionists and information clerks
4217	Typists	4110	Secretaries and keyboard-operating clerks
5111	Farmers	6130	Crop and animal producers
5112	Horticultural trades	6112	Gardeners, horticultural and nursery growers
5113	Gardeners and grounds(wo)men	6112	Gardeners, horticultural and nursery growers
5119	Agricult and fishing trades n.e.c.	6150	Fishery workers, hunters and trappers
5211	Smiths and forge workers	7221	Blacksmiths, hammer-smiths and forging-press workers
5212	Moulders, core makers, die casters	7211	Metal moulders and coremakers
5213	Sheet metal workers	7213	Sheet-metal workers
5214	Mtl plate wrkrs, shipwrig, riveters	7214	Structural-metal preparers and erectors
5215	Welding trades	7212	Welders and flame cutters
5216	Pipe fitters	7136	Plumbers and pipe fitters
5221	Metal mach setter & setter-operator	7223	Machine-tool setters and setter-operators
5222	Tool mkrs, tool fters & markers-out	7222	Tool-makers and related workers
5223	Mtl working prod & maintnce fitter	7230	Machinery mechanics and fitters
5224	Prec instrument makers & repairers	7311	Precision-instrument makers and repairers
5231	Motor mechanics, auto engineers	7231	Motor vehicle mechanics and fitters
5232	Vehicle body builders and repairers	7213	Sheet-metal workers
5233	Auto electricians	7241	Electrical mechanics fitters and servicers
5234	Vehicle spray painters	7141	Painters and related workers
5241	Electricians, electrical fitters	7137	Building and related electricians
5242	Telecommunications engineers	7244	Telegraph and telephone installers and servicers
5243	Lines repairers and cable jointers	7245	Electrical line installers, repairers and cable jointers
5244	TV, video and audio engineers	7242	Electronics mechanics, fitters and servicers

SOC2000		ISCO88	
5245	Comp engineer, installn & maintnce	7242	Electronics mechanics, fitters and servicers
5249	Elec & electronic engineer n.e.c.	7242	Electronics mechanics, fitters and servicers
5311	Steel erectors	7214	Structural-metal preparers and erectors
5312	Bricklayers, masons	7122	Bricklayers and stonemasons
5313	Roofers, roof tilers and slaters	7131	Roofers
5314	Plumb, hea & ventilating engineers	7136	Plumbers and pipe fitters
5315	Carpenters and joiners	7124	Carpenters and joiners
5316	Glaziers, window fabric and fitters	7135	Glaziers
5319	Construction trades n.e.c.	7121	Builders
5321	Plasterers	7133	Plasterers
5322	Floorers and wall tilers	7132	Floor layers and tile setters
5323	Painters and decorators	7141	Painters and related workers
5411	Weavers and knitters	7432	Weavers, knitters and related workers
5412	Upholsterers	7437	Upholsterers and related workers
5413	Leather and related trades	7442	Shoe-makers and related workers
5414	Tailors and dressmakers	7433	Tailors, dressmakers and hatters
5419	Text, garment & related trades nec.	7430	Textile, garment and related trades workers
5421	Origntrs, compositors & print preps	7341	Compositors, typesetters and related workers
5422	Printers	7341	Compositors, typesetters and related workers
5423	Bookbinders and print finishers	7345	Bookbinders and related workers
5424	Screen printers	7346	Silk-screen, block and craft textile printers
5431	Butchers, meat cutters	7411	Butchers, fishmongers and related food preparers
5432	Bakers, flour confectioners	7412	Bakers, pastry-cooks and confectionery makers
5433	Fishmongers, poultry dressers	7411	Butchers, fishmongers and related food preparers
5434	Chefs, cooks	5122	Cooks
5491	Glss & cermic mkr, decotr, finshr	7320	Potters, glass-makers and related trades workers
5492	Furntre mkr, other crft woodworkers	7422	Cabinetmakers and related workers
5493	Pattern makers (moulds)	7422	Cabinetmakers and related workers
5494	Musicl instrument makers and tuners	7312	Musical-instrument makers and tuners
5495	Goldsmth, slvrsmth, prec stone wrkr	7313	Jewellery and precious-metal workers
5496	Floral arrangers, florists	3471	Decorators and commercial designers
5499	Hand craft occupations n.e.c.	7330	Handicraft workers in wood, textile, leather etc
6111	Nursing auxiliaries and assistants	5132	Institution-based personal care workers
6112	Amb staff (excluding paramedics)	5132	Institution-based personal care workers
6113	Dental nurses	5132	Institution-based personal care workers
6114	Houseprnts and residential wardens	5132	Institution-based personal care workers
6115	Care assistants and home carers	5133	Home-based personal care workers
6121	Nursery nurses	5131	Child-care workers
6122	Childminders and rel occupations	5131	Child-care workers
6123	Playgroup leaders & assistants	5131	Child-care workers
6124	educal assistants	5131	Child-care workers
6131	Veterinary nurses and assistants	3227	Veterinary assistants
6139	Animal care occupations n.e.c.	3227	Veterinary assistants
6211	Sports and leisure assistants	5149	Other personal services workers NEC
6212	Travel agents	4221	Travel agency and related clerks
6213	Travel and tour guides	5113	Travel guides
6214	Air travel assistants	5111	Travel attendants and travel stewards
6215	Rail travel assistants	5112	Transport conductors
6219	Leisure & travel serv occuptns nec.	5110	Travel attendants and related workers
6221	Hairdressers, barbers	5141	Hairdressers, barbers, beauticians and related workers
6222	Beauticians and related occupations	5141	Hairdressers, barbers, beauticians and related workers
6231	Housekprs and related occupations	5121	Housekeepers and related workers
6232	Caretakers	9141	Building caretakers
6291	Undertakers and mortuary assistants	5143	Undertakers and embalmers
6292	Pest control officers	7143	Building structure cleaners
7111	Sales and retail assistants	5220	Shop, stall and market salespersons and demonstrators
7112	Retail cashiers/check-out operators	5220	Shop, stall and market salespersons and demonstrators
7113	Telephone salespersons	9113	Door-to-door and telephone salespersons
7121	Collector salsprns and cred agents	9113	Door-to-door and telephone salespersons

SOC2000		ISCO88	
7122	Debt, rent and other cash collectrs	9153	Vending-machine money collectors, meter readers etc
7123	Rounds(wo)men and van salespersons	9113	Door-to-door and telephone salespersons
7124	Mrkt and street traders and assist	5220	Shop, stall and market salespersons and demonstrators
7125	Merchandisers and window dressers	3471	Decorators and commercial designers
7129	Sales related occupations n.e.c.	3415	Technical and commercial sales representatives
7211	Call centre agents & operators	4220	Client information clerks
7212	Customer care occupations	4220	Client information clerks
8111	Food, drink & tobac process operat	8270	Food and related products machine operators
8112	Glass and ceramics process oprties	8130	Glass, ceramics and related plant operators
8113	Textile process operatives	8260	Textile-, fur- and leather-products machine operators
8114	Chem and related process operatives	8150	Chemical-processing-plant operators
8115	Rubber process operatives	8231	Rubber-products machine operators
8116	Plastics process operatives	8232	Plastic-products machine operators
8117	Mtl mknng & treating procss operative	8120	Metal-processing plant operators
8118	Electroplaters	8223	Metal finishing-, plating- and coating-machine operators
8119	Process operatives n.e.c.	8100	Stationary plant and related operators
8121	Paper and wood machine operatives	8140	Wood-processing- and papermaking-plant operators
8122	Coal mine operatives	8111	Mining plant operators
8123	Quarry workers and related oprtives	8112	Mineral-ore and stone-processing-plant operators
8124	Energy plant operatives	8160	Power-production and related plant operators
8125	Metal working machine operatives	8211	Machine-tool operators
8126	Water and sewerage plant operatives	8163	Incinerator, water-treatment and related plant operators
8129	Plant and machine operatives n.e.c.	8290	Other machine operators NEC
8131	Assemblers (electrical products)	8282	Electrical-equipment assemblers
8132	Assemblers (veh and metal goods)	8281	Mechanical-machinery assemblers
8133	Routine inspectors and testers	8290	Other machine operators NEC
8134	Weighers, graders, sorters	8290	Other machine operators NEC
8135	Tyre, exhaust and windscrn fitters	7231	Motor vehicle mechanics and fitters
8136	Clothing cutters	8269	Textile-, fur- and leather-products machine operators NEC
8137	Sewing machinists	8263	Sewing-machine operators
8138	Routine laboratory testers	8290	Other machine operators NEC
8139	Assemblers and routine oprtives nec.	8290	Other machine operators NEC
8141	Scaffolders, staggers, riggers	7129	Building frame and related trades workers NEC
8142	Road construction operatives	9312	Construction and maintenance labourers: roads, dams etc
8143	Rail constructn & maintnce oprtives	9312	Construction and maintenance labourers: roads, dams etc
8149	Construction operatives n.e.c.	9313	Building construction labourers
8211	Heavy goods vehicle drivers	8324	Heavy truck and lorry drivers
8212	Van drivers	8322	Car, taxi and van drivers
8213	Bus and coach drivers	8323	Bus and tram drivers
8214	Taxi, cab drivers and chauffeurs	8322	Car, taxi and van drivers
8215	Driving instructors	3340	Other teaching associate professionals
8216	Rail transport operatives	8312	Railway brakers, signallers and shunters
8217	Seafarer (m navy), brge, lght, boat	8340	Ships' deck crews and related workers
8218	Air transport operatives	9330	Transport labourers and freight handlers
8219	Transport operatives n.e.c.	9330	Transport labourers and freight handlers
8221	Crane drivers	8333	Crane, hoist and related plant operators
8222	Fork-lift truck drivers	8334	Lifting-truck operators
8223	Agricultural machinery drivers	8331	Motorised farm and forestry plant operators
8229	Mobile machine drivers & operatives	8330	Agricultural and other mobile plant operators
9111	Farm workers	9211	Farm-hands and labourers
9112	Forestry workers	9212	Forestry labourers
9119	Fishng & agric reltd occupatns nec.	9210	Agricultural, fishery and related labourers
9121	Labrers build & woodworking trades	9313	Building construction labourers
9129	Lab oth const trades n.e.c.	9312	Construction and maintenance labourers: roads, dams etc
9131	Labourers in foundries	9320	Manufacturing labourers
9132	Indust cleaning process occupations	9132	Helpers and cleaners in offices, hotels etc
9133	Printing machine minders and assist	9320	Manufacturing labourers
9134	Packers, bottlers, canners, fillers	9320	Manufacturing labourers
9139	Labrs process & plant opertns nec.	9320	Manufacturing labourers

SOC2000		ISCO88	
9141	Stevadores, dockers and slingers	9330	Transport labourers and freight handlers
9149	Oth good hndlng & storage occup nec	9330	Transport labourers and freight handlers
9211	Post wrkr, mail sort, msngr, courir	9151	Messengers, package and luggage porters and deliverers
9219	Elementary office occupatns n.e.c.	9151	Messengers, package and luggage porters and deliverers
9221	Hospital porters	9132	Helpers and cleaners in offices, hotels etc
9222	Hotel porters	9150	Messengers, porters, doorkeepers and related workers
9223	Kitchen and catering assistants	9132	Helpers and cleaners in offices, hotels etc
9224	Waiters, waitresses	5123	Waiters, waitresses and bartenders
9225	Bar staff	5123	Waiters, waitresses and bartenders
9226	Leisure and theme park attendants	9152	Doorkeepers, watchpersons and related workers
9229	Elmntry persnal servcs occup n.e.c.	9150	Messengers, porters, doorkeepers and related workers
9231	Window cleaners	9142	Vehicle, window and related cleaners
9232	Road sweepers	9162	Sweepers and related labourers
9233	Cleaners, domestics	9130	Domestic and related helpers, cleaners and launderers
9234	Launderers, dry cleaners, pressers	9133	Hand-launderers and pressers
9235	Refuse and salvage occupations	9161	Garbage collectors
9239	Elementary cleaning occupns nec.	9162	Sweepers and related labourers
9241	Security guards and rel occupations	9152	Doorkeepers, watchpersons and related workers
9242	Traffic wardens	5169	Protective services workers NEC
9243	School crossing patrol attendants	9152	Doorkeepers, watchpersons and related workers
9244	School mid-day assistants	5131	Child-care workers
9245	Car park attendants	9152	Doorkeepers, watchpersons and related workers
9249	Elementary security occupation nec.	9152	Doorkeepers, watchpersons and related workers
9251	Shelf fillers	5220	Shop, stall and market salespersons and demonstrators
9259	Elementary sales occupations nec.	9151	Messengers, package and luggage porters and deliverers

Note

Where two values of ISCO88 are given for one value of SOC2000 the determining factor is the size of the establishment. If the size of the establishment is ten or more employees then the first ISCO value applies; if less than ten then the second ISCO value applies. The size of the establishment is recorded in the LFS variables MPNE02, MPNS02 and equivalents.

Annex III (d) – SOC2010 to ISCO-08

The conversion from SOC2010 to ISCO-08 is carried out during LFS processing using a probabilistic mapping tool. For further details and to request copies of the mapping tool (available in SAS and SPSS) contact: sean.milburn@ons.gov.uk
 For details of ISCO-08 see: <http://www.ilo.org/public/english/bureau/stat/isco/isco08/>

Annex IV (a) – ISO country classification in the LFS from 2012 onwards

Code	Country	Group
AD	Andorra	Other European countries
AE	United Arab Emirates	Near and Middle East
AF	Afghanistan	South and South East Asia
AG	Antigua and Barbuda	Central America and Caribbean
AI	Anguilla	Central America and Caribbean
AL	Albania	Other European countries
AM	Armenia	Near and Middle East
AN	Netherlands Antilles	Central America and Caribbean
AO	Angola	Other Africa
AR	Argentina	South America
AT	Austria	European Union
AU	Australia	Australia, Oceania and Other Territories
AW	Aruba	Central America and Caribbean
AZ	Azerbaijan	Near and Middle East
BA	Bosnia Herzegovina	Other European countries
BB	Barbados	Central America and Caribbean
BD	Bangladesh	South and South East Asia
BE	Belgium	European Union
BF	Burkina Faso	Other Africa
BG	Bulgaria	European Union
BH	Bahrain	Near and Middle East
BI	Burundi	Other Africa
BJ	Benin	Other Africa
BL	Saint Barthelemy	Central America and Caribbean
BM	Bermuda	North America
BN	Brunei	South and South East Asia
BO	Bolivia	South America
BR	Brazil	South America
BS	Bahamas	Central America and Caribbean
BT	Bhutan	South and South East Asia
BW	Botswana	Other Africa
BY	Belarus	Other European countries
BZ	Belize	Central America and Caribbean
CA	Canada	North America
CD	Republic Democratic of Congo	Other Africa
CF	Central African Republic	Other Africa
CG	Congo	Other Africa
CH	Switzerland	Candidate and EFTA countries
CI	Ivory Coast	Other Africa
CL	Chile	South America
CM	Cameroon	Other Africa
CN	China	East Asia
CO	Colombia	South America
CR	Costa Rica	Central America and Caribbean
CS	Czechoslovakia ¹	Other European countries
CU	Cuba	Central America and Caribbean
CV	Cape Verde	Other Africa
CY	Cyprus	European Union
CZ	Czech Republic	European Union
DE	Germany	European Union
DJ	Djibouti	Other Africa
DK	Denmark	European Union
DM	Dominica	Central America and Caribbean
DO	Dominican Republic	Central America and Caribbean
DZ	Algeria	North Africa
EC	Ecuador	South America
EE	Estonia	European Union

Code	Country	Group
EL	Greece	European Union
ER	Eritrea	Other Africa
ES	Spain	European Union
ET	Ethiopia	Other Africa
FI	Finland	European Union
FJ	Fiji	Australia, Oceania and Other Territories
FK	Falkland Islands (Malvinas)	South America
FM	Micronesia	Australia, Oceania and Other Territories
FO	Faroe Islands	Other European countries
FR	France	European Union
GA	Gabon	Other Africa
GD	Grenada	Central America and Caribbean
GE	Georgia	Near and Middle East
GG	Guernsey	Other European countries
GH	Ghana	Other Africa
GI	Gibraltar	Other European countries
GL	Greenland ²	North America
GM	Gambia	Other Africa
GN	Guinea	Other Africa
GQ	Equatorial Guinea	Other Africa
GT	Guatemala	Central America and Caribbean
GW	Guinea-Bissau	Other Africa
GY	Guyana	South America
HN	Honduras	Central America and Caribbean
HR	Croatia	Candidate and EFTA countries
HT	Haiti	Central America and Caribbean
HU	Hungary	European Union
ID	Indonesia	South and South East Asia
IE	Ireland	European Union
IL	Israel	Near and Middle East
IM	Isle of Man	Other European countries
IN	India	South and South East Asia
IQ	Iraq	Near and Middle East
IR	Iran	Near and Middle East
IS	Iceland	Candidate and EFTA countries
IT	Italy	European Union
JE	Jersey	Other European countries
JM	Jamaica	Central America and Caribbean
JO	Jordan	Near and Middle East
JP	Japan	East Asia
KE	Kenya	Other Africa
KG	Kyrgyzstan	Near and Middle East
KH	Cambodia	South and South East Asia
KI	Kiribati	Australia, Oceania and Other Territories
KM	Comoros	Other Africa
KN	Saint Kitts and Nevis	Central America and Caribbean
KP	Dem. People's Republic of Korea (North)	East Asia
KR	Republic of Korea (South)	East Asia
KW	Kuwait	Near and Middle East
KY	Cayman Islands	Central America and Caribbean
KZ	Kazakhstan	Near and Middle East
LA	Laos	South and South East Asia
LB	Lebanon	Near and Middle East
LC	Saint Lucia	Central America and Caribbean
LI	Liechtenstein	Candidate and EFTA countries
LK	Sri Lanka	South and South East Asia
LR	Liberia	Other Africa
LS	Lesotho	Other Africa
LT	Lithuania	European Union
LV	Latvia	European Union

Code	Country	Group
LU	Luxembourg	European Union
MA	Morocco	North Africa
MC	Monaco	Other European countries
MD	Republic of Moldova	Other European countries
ME	Montenegro	Candidate and EFTA countries
MF	Saint Martin	Central America and Caribbean
MH	Marshall Islands	Australia, Oceania and Other Territories
MK	FYR Macedonia	Candidate and EFTA countries
ML	Mali	Other Africa
MM	Myanmar	South and South East Asia
MN	Mongolia	East Asia
MR	Mauritania	Other Africa
MS	Montserrat	Central America and Caribbean
MT	Malta	European Union
MU	Mauritius	Other Africa
MV	Maldives	South and South East Asia
MW	Malawi	Other Africa
MX	Mexico	Central America and Caribbean
MY	Malaysia	South and South East Asia
MZ	Mozambique	Other Africa
NA	Namibia	Other Africa
NC	New Caledonia	Australia, Oceania and Other Territories
NE	Niger	Other Africa
NG	Nigeria	Other Africa
NI	Nicaragua	Central America and Caribbean
NL	Netherlands	European Union
NN	Recognised non-citizen ³	-
NO	Norway	Candidate and EFTA countries
NP	Nepal	South and South East Asia
NR	Nauru	Australia, Oceania and Other Territories
NZ	New Zealand	Australia, Oceania and Other Territories
OM	Oman	Near and Middle East
PA	Panama	Central America and Caribbean
PE	Peru	South America
PF	French Polynesia	Australia, Oceania and Other Territories
PG	Papua New Guinea	Australia, Oceania and Other Territories
PH	Philippines	South and South East Asia
PK	Pakistan	South and South East Asia
PL	Poland	European Union
PM	Saint Pierre and Miquelon	North America
PN	Pitcairn	Australia, Oceania and Other Territories
PR	Puerto Rico ⁴	Central America and Caribbean
PS	Palestine ⁴	Near and Middle East
PT	Portugal	European Union
PW	Palau	Australia, Oceania and Other Territories
PY	Paraguay	South America
QA	Qatar	Near and Middle East
RO	Romania	European Union
RS	Serbia	Other European countries
RU	Russian Federation	Other European countries
RW	Rwanda	Other Africa
SA	Saudi Arabia	Near and Middle East
SB	Soloman Islands	Australia, Oceania and Other Territories
SC	Seychelles	Other Africa
SD	Sudan	Other Africa
SE	Sweden	European Union
SG	Singapore	South and South East Asia
SH	Saint Helena	Other Africa
SI	Slovenia	European Union
SK	Slovak Republic	European Union

Code	Country	Group
SM	San Marino	Other European countries
SN	Senegal	Other Africa
SO	Somalia	Other Africa
SR	Suriname	South America
SS	South Sudan	Other Africa
ST	Sao Tome and Principe	Other Africa
SU	Soviet Union ¹	Other European countries
SV	El Salvador	Central America and Caribbean
SY	Syria	Near and Middle East
SZ	Swaziland	Other Africa
TC	Turks and Caicos Islands	Central America and Caribbean
TD	Chad	Other Africa
TF	French Southern Territories	South America
TG	Togo	Other Africa
TH	Thailand	South and South East Asia
TJ	Tajikistan	Near and Middle East
TL	East Timor	South and South East Asia
TM	Turkmenistan	Near and Middle East
TN	Tunisia	North Africa
TO	Tonga	Australia, Oceania and Other Territories
TR	Turkey	Candidate and EFTA countries
TT	Trinidad and Tobago	Central America and Caribbean
TU	Tunisia	North Africa
TV	Tuvalu	Australia, Oceania and Other Territories
TW	Taiwan	East Asia
TZ	Tanzania	Other Africa
UA	Ukraine	Other European countries
UG	Uganda	Other Africa
UK	United Kingdom	European Union
US	United States of America	North America
UY	Uruguay	South America
UZ	Uzbekistan	Near and Middle East
VA	Vatican City	Other European countries
VC	Saint Vincent and the Grenadines	Central America and Caribbean
VE	Venezuela	South America
VG	British Virgin Islands	Central America and Caribbean
VN	Vietnam	South and South East Asia
VU	Vanuatu	Australia, Oceania and Other Territories
WF	Wallis and Futuna	Australia, Oceania and Other Territories
WS	Samoa	Australia, Oceania and Other Territories
XK	Kosovo (UNSCR1244)	Other European countries
YE	Yemen	Near and Middle East
YT	Mayotte	Other Africa
YU	Yugoslavia ¹	Other European countries
ZA	South Africa	Other Africa
ZM	Zambia	Other Africa
ZW	Zimbabwe	Other Africa
05	-	North Africa
06	-	Other Africa
07	-	North America
08	-	Central America and Caribbean
09	-	South America
10	-	East Asia
11	-	Near and Middle East
12	-	South and South East Asia
13	-	Australia, Oceania and Other Territories
14	-	Other + Stateless

Notes

- 1 Country of Birth only
- 2 Country of Birth, Work and Residence-one-year-ago only
- 3 Nationality only
- 4 Not in census list

Annex IV (b) - CRY07 to ISO country look-up (including 2014 amendments)

CRY07		ILO Country code	
4	Afghanistan	AF	Afghanistan
8	Albania	AL	Albania
10	Antarctica	14	Other + Stateless
12	Algeria	DZ	Algeria
16	American Samoa	13	Australia, Oceania and Other Territories
20	Andorra	AD	Andorra
24	Angola	AO	Angola
28	Antigua and Barbuda	AG	Antigua and Barbuda
31	Azerbaijan	AZ	Azerbaijan
32	Argentina	AR	Argentina
36	Australia	AU	Australia
40	Austria	AT	Austria
44	Bahamas, The	BS	Bahamas
48	Bahrain	BH	Bahrain
50	Bangladesh	BD	Bangladesh
51	Armenia	AM	Armenia
52	Barbados	BB	Barbados
56	Belgium	BE	Belgium
60	Bermuda	BM	Bermuda
64	Bhutan	BT	Bhutan
68	Bolivia	BO	Bolivia
70	Bosnia and Herzegovina	BA	Bosnia Herzegovina
72	Botswana	BW	Botswana
74	Bouvet Island	14	Other + Stateless
76	Brazil	BR	Brazil
84	Belize	BZ	Belize
86	British Indian Ocean Territory	13	Australia, Oceania and Other Territories
90	Solomon Islands	SB	Soloman Islands
92	British Virgin Islands	08	Central America and Caribbean
96	Brunei	BN	Brunei
100	Bulgaria	BG	Bulgaria
104	Burma	MM	Myanmar
108	Burundi	BI	Burundi
112	Belarus	BY	Belarus
116	Cambodia	KH	Cambodia
120	Cameroon	CM	Cameroon
124	Canada	CA	Canada
132	Cape Verde	CV	Cape Verde
136	Cayman Islands	08	Central America and Caribbean
140	Central African Republic	CF	Central African Republic
144	Sri Lanka	LK	Sri Lanka
148	Chad	TD	Chad
152	Chile	CL	Chile
156	China	CN	China
158	China (Taiwan)	TW	Taiwan
162	Christmas Island	12	South and South East Asia
166	Cocos (Keeling) Islands	12	South and South East Asia
170	Colombia	CO	Colombia
174	Comoros	06	Other Africa
175	Mayotte	06	Other Africa
178	Congo	CG	Congo
180	Congo (Democratic Republic)	CD	Republic Democratic of Congo
184	Cook Islands	13	Australia, Oceania and Other Territories
188	Costa Rica	CR	Costa Rica
191	Croatia	HR	Croatia
192	Cuba	CU	Cuba
203	Czech Republic	CZ	Czech Republic
204	Benin	BJ	Benin

CRY07

208	Denmark
212	Dominica
214	Dominican Republic
218	Ecuador
222	El Salvador
226	Equatorial Guinea
231	Ethiopia
232	Eritrea
233	Estonia
234	Faroe Islands
238	Falkland Islands
239	South Georgia and South Sandwich Island
242	Fiji
246	Finland
248	Aland Islands
250	France
254	French Guiana
258	French Polynesia
260	French Southern Territories
262	Djibouti
266	Gabon
268	Georgia
270	Gambia, The
275	West Bank (Including East Jerusalem)
276	Germany
288	Ghana
292	Gibraltar
296	Kiribati
300	Greece
304	Greenland
308	Grenada
312	Guadeloupe
316	Guam
320	Guatemala
324	Guinea
328	Guyana
332	Haiti
334	Heard Island and McDonald Islands
336	Vatican City
340	Honduras
344	Hong Kong (Special Administrative Region)
348	Hungary
352	Iceland
356	India
360	Indonesia
364	Iran
368	Iraq
372	Ireland
376	Israel
380	Italy
384	Ivory Coast
388	Jamaica
392	Japan
398	Kazakhstan
400	Jordan
404	Kenya
408	Korea (North)
410	Korea (South)

ILO Country code

DK	Denmark
DM	Dominica
DO	Dominican Republic
EC	Ecuador
SV	El Salvador
GQ	Equatorial Guinea
ET	Ethiopia
ER	Eritrea
EE	Estonia
14	Other + Stateless
09	South America
09	South America
FJ	Fiji
FI	Finland
FI	Finland
FR	France
09	South America
PF	French Polynesia
14	Other + Stateless
DJ	Djibouti
GA	Gabon
GE	Georgia
GM	Gambia
PS	Palestine
DE	Germany
GH	Ghana
GI	Gibraltar
13	Australia, Oceania and Other Territories
EL	Greece
GL	Greenland
GD	Grenada
08	Central America and Caribbean
13	Australia, Oceania and Other Territories
GT	Guatemala
GN	Guinea
GY	Guyana
HT	Haiti
14	Other + Stateless
VA	Vatican City
HN	Honduras
CN	China
HU	Hungary
IS	Iceland
IN	India
ID	Indonesia
IR	Iran
IQ	Iraq
IE	Ireland
IL	Israel
IT	Italy
CI	Ivory Coast
JM	Jamaica
JP	Japan
KZ	Kazakhstan
JO	Jordan
KE	Kenya
KP	Dem. People's Republic of Korea (North)
KR	Republic of Korea (South)

CRY07

414	Kuwait
417	Kyrgyzstan
418	Laos
422	Lebanon
426	Lesotho
428	Latvia
430	Liberia
434	Libya
438	Liechtenstein
440	Lithuania
442	Luxembourg
446	Macao (Special Administrative Region)
450	Madagascar
454	Malawi
458	Malaysia
462	Maldives
466	Mali
470	Malta
474	Martinique
478	Mauritania
480	Mauritius
484	Mexico
492	Monaco
496	Mongolia
498	Moldova
499	Montenegro
500	Montserrat
504	Morocco
508	Mozambique
512	Oman
516	Namibia
520	Nauru
524	Nepal
528	Netherlands
530	Netherlands Antilles
531	Curacao
533	Aruba
534	St Maarten (Dutch part)
535	Bonaire, St Eustatius and Saba
540	New Caledonia
548	Vanuatu
554	New Zealand
558	Nicaragua
562	Niger
566	Nigeria
570	Niue
574	Norfolk Island
578	Norway
580	Northern Mariana Islands
581	US Minor Outlying Islands
583	Micronesia
584	Marshall Islands
585	Palau
586	Pakistan
591	Panama
598	Papua New Guinea
600	Paraguay
604	Peru

ILO Country code

KW	Kuwait
KG	Kyrgyzstan
LA	Laos
LB	Lebanon
LS	Lesotho
LV	Latvia
LR	Liberia
LY	Libya
LI	Liechtenstein
LT	Lithuania
LU	Luxembourg
CN	China
MG	Madagascar
MW	Malawi
MY	Malaysia
MV	Maldives
ML	Mali
MT	Malta
08	Central America and Caribbean
MR	Mauritania
MU	Mauritius
MX	Mexico
MC	Monaco
MN	Mongolia
MD	Republic of Moldova
ME	Montenegro
08	Central America and Caribbean
MA	Morocco
MZ	Mozambique
OM	Oman
NA	Namibia
13	Australia, Oceania and Other Territories
NP	Nepal
NL	Netherlands
AN	Netherlands Antilles
08	Central America and Caribbean
08	Central America and Caribbean
08	Central America and Caribbean
08	Central America and Caribbean
NC	New Caledonia
VU	Vanuatu
NZ	New Zealand
NI	Nicaragua
NE	Niger
NG	Nigeria
13	Australia, Oceania and Other Territories
13	Australia, Oceania and Other Territories
NO	Norway
13	Australia, Oceania and Other Territories
US	United States of America
FM	Micronesia
13	Australia, Oceania and Other Territories
13	Australia, Oceania and Other Territories
PK	Pakistan
PA	Panama
PG	Papua New Guinea
PY	Paraguay
PE	Peru

CRY07

608	Philippines
612	Pitcairn, Henderson, Ducie and Oeno Isla
616	Poland
620	Portugal
624	Guinea-Bissau
626	East Timor
630	Puerto Rico
634	Qatar
638	Reunion
642	Romania
643	Russia
646	Rwanda
652	St Barthelemy
654	St Helena
659	St Kitts and Nevis
660	Anguilla
662	St Lucia
663	St Martin
666	St Pierre and Miquelon
670	St Vincent and The Grenadines
674	San Marino
678	Sao Tome and Principe
682	Saudi Arabia
686	Senegal
688	Serbia
690	Seychelles
694	Sierra Leone
702	Singapore
703	Slovakia
704	Vietnam
705	Slovenia
706	Somalia
710	South Africa
716	Zimbabwe
728	South Sudan
729	Sudan
732	Western Sahara
740	Surinam
744	Svalbard and Jan Mayen
748	Swaziland
752	Sweden
756	Switzerland
760	Syria
762	Tajikistan
764	Thailand
768	Togo
772	Tokelau
776	Tonga
780	Trinidad and Tobago
784	United Arab Emirates
788	Tunisia
792	Turkey
795	Turkmenistan
796	Turks And Caicos Islands
798	Tuvalu
800	Uganda
804	Ukraine
807	Macedonia
818	Egypt

ILO Country code

PH	Philippines
13	Australia, Oceania and Other Territories
PL	Poland
PT	Portugal
GW	Guinea-Bissau
TL	East Timor
PR	Puerto Rico
QA	Qatar
FR	France
RO	Romania
RU	Russian Federation
RW	Rwanda
BL	Saint Barthelemy
06	Other Africa
08	Central America and Caribbean
08	Central America and Caribbean
08	Central America and Caribbean
MF	St Martin
PM	Saint Pierre and Miquelon
08	Central America and Caribbean
SM	San Marino
ST	Sao Tome and Principe
SA	Saudi Arabia
SN	Senegal
RS	Serbia
SC	Seychelles
SL	Sierra Leone
SG	Singapore
SK	Slovak Republic
VN	Vietnam
SI	Slovenia
SO	Somalia
ZA	South Africa
ZW	Zimbabwe
SS	South Sudan
SD	Sudan
05	North Africa
SR	Suriname
14	Other + Stateless
SZ	Swaziland
SE	Sweden
CH	Switzerland
SY	Syria
TJ	Tajikistan
TH	Thailand
TG	Togo
13	Australia, Oceania and Other Territories
13	Australia, Oceania and Other Territories
TT	Trinidad and Tobago
AE	United Arab Emirates
TN	Tunisia
TR	Turkey
TM	Turkmenistan
08	Central America and Caribbean
13	Australia, Oceania and Other Territories
UG	Uganda
UA	Ukraine
MK	FYR Macedonia
EG	Egypt

CRY07

831	Guernsey
832	Jersey
833	Isle of Man
834	Tanzania
840	United States
850	United States Virgin Islands
854	Burkina
858	Uruguay
860	Uzbekistan
862	Venezuela
876	Wallis and Futuna
882	Samoa
882	Samoa
887	Yemen
891	Kosovo and Metohia
894	Zambia
901	Cyprus (European Union)
902	Cyprus (Non-European Union)
903	Cyprus (Not Otherwise Specified)
911	Spain (Except Canary Islands)
912	Canary Islands
913	Spain NOS
951	Kosovo
971	Czechoslovakia NOS
972	USSR NOS
973	Yugoslavia NOS
974	Serbia And Montenegro NOS
981	Europe NOS
982	Africa NOS
983	Middle East NOS
984	Asia (Except Middle East) NOS
985	North America NOS
986	Central America NOS
987	South America NOS
988	Caribbean NOS
989	Antarctica And Oceania NOS
991	At Sea
992	In The Air

ILO Country code

GG	Guernsey
JE	Jersey
IM	Isle of Man
TZ	Tanzania
US	United States of America
08	Central America and Caribbean
BF	Burkina Faso
UY	Uruguay
UZ	Uzbekistan
VE	Venezuela
13	Australia, Oceania and Other Territories
13	Australia, Oceania and Other Territories
13	Australia, Oceania and Other Territories
YE	Yemen
XK	Kosovo (UNSCR1244)
ZM	Zambia
CY	Cyprus
CY	Cyprus
CY	Cyprus
ES	Spain
ES	Spain
ES	Spain
XK	Kosovo (UNSCR1244)
CZ	Czech Republic
RU	Russian Federation
04	Other Europe
04	Other Europe
14	Other + Stateless
06	Other Africa
11	Near and Middle East
12	South and South East Asia
07	North America
08	Central America and Caribbean
09	South America
08	Central America and Caribbean
14	Other + Stateless
14	Other + Stateless
14	Other + Stateless

Annex V (a) – Eurostat variable names and their UK LFS equivalents (2012 to 2013)

The UK LFS historically has tended to rename Eurostat variables. Generally this involves adding an ‘E’ prefix and truncating the Eurostat name, for example COBFATH (country of birth of father) becomes ECOBFAT.

Col	Eurostat name	LFS name	Description
1-2	HHSEQNUM	EPERSNO	Person number within household
3	HHLINK	ERELHOH	Relationship to head of household
4-5	HHSPOU	ESPOUSE	Sequence number of spouse or partner
6-7	HHFATH	EFATHER	Sequence number of father
8-9	HHMOTH	EMOTHER	Sequence number of mother
10	SEX	ESEX	Sex
11-14	YEARBIR	EYOB	Year of birth
15	DATEBIR	EDOB	Date of birth in relation to end of ref period
16	MARSTAT	EMARSTAT	Marital status
17-18	NATIONAL	ENAT	Nationality
19-20	REARESID	EYRSRES	Years of residence
21-22	COUNTRYB	ECOB	Country of birth
23	PROXY	EPROXY	Nature of participation in survey
24	WSTATOR	EWKSTATR	Work status in ref week
25-26	NOWKREAS	ERESAWYR	Reason for not working but having job
27	STAPRO	ESTATR	Professional status
28	SIGNISAL	EFISAL	Continuing receipt of wage or salary
29-31	NACE3D	ENACE08	Industry / Economic activity of local unit
32-35	ISCO4D	EISCOMR	Occupation
36	SUPVISOR	ESUPVIS	Supervisory responsibilities
37-38	SIZEFIRM	ENUMPR	Number of persons working at the local unit / establishment
39-40	COUNTRYW	ECONWRK	Country of place of work
41-42	REGIONW	EREGWK10	Region of place of work – NUTS10 level 2
43-46	YSTARTWK	EYRSTRTR	Year started with current employer or as self employed
47-48	MSTARTWK	EMNSTRTR	Month started with current employer or as self employed
49	WAYJFOUN	EHOWGET	Involvement of public employment office in job find
50	FTPT	EFTPTWKR	Full, part-time distinction (main job)
51	FTPTREAS	EYPTJOB	Reasons for part-time work
52	TEMP	EPERM	Permanency of main job
53	TEMPREAS	EWHYTMP	Reasons for having a temporary job / work contract of limited duration
54	TEMPDUR	EDURTMPR	Total duration of temporary job
55	TEMPAGCY	ETMPCON	Contract with a temporary employment agency
56	SHIFTWK	ESHIFTR	Shiftwork (in main job)
57	EVENWK	EEVENR	Evening work (in main job)
58	NIGHTWK	ENIGHTR	Night work (in main job)
59	SATWK	ESATR	Saturday work (in main job)
60	SUNWK	ESUNR	Sunday work (in main job)
61-62	HWUSUAL	EUSUHRR	Number of hours per week usually worked
63-64	HWACTUAL	EACTHRR	Number of hours actually worked during reference week
65-66	HWOVERP	EACTPOT	Whether did paid overtime during reference week (in main job)
67-68	HWOVERPU	EACTUOT	Whether did unpaid overtime during reference week (in main job)
69-70	HOURREAS	EWHYDIFR	Main reason actual hours differ from usual hours
71	WISHMORE	EMHRSR	Wish to work usually more than current number of hours
72	WAYMORE	EWAYHRS	Way in which want to work more hours
73-74	HWWISH	ENUMHRSR	Total number of hours respondent would like to work.
75	HOMEWK	EHOMER	Whether works at home
76	LOOKOJ	EADDWKR	Whether looking for another job

Eurostat variable names and their UK LFS equivalents (2012 to 2013) cont'd

Col	Eurostat name	LFS name	Description
77	LOOKREAS	EADDREA	Reason for looking for another job
78	EXIST2J	ESECJOB	Existence of more than one job or business
79	STAPRO2J	ESTAT2R	Professional status in second job
80-81	NACE2J2D	ENACE208	Economic activity of the local unit (in second job)
82-83	HWACTUA2	EACTHR2R	Number of hours actually worked during reference week in second job
84	EXISTPR	EEVWKR	Existence of previous employment experience
85-88	YEARPR	EYRLASTR	Year in which respondent last worked
89-90	MONTHPR	EMNLASTR	Month in which respondent last worked
91-92	LEAVRS	EWHYLFTR	Main reason for leaving last job or business
93	STAPROPR	ESTATLR	Professional status in last job
94-95	NACEPR2D	ENACEL08	Economic activity of the local unit in which respondent last worked
96-98	ISCOPR3D	EISCOLR	Occupation of last job
99	SEEKWORK	ELOOKR	Seeking employment during previous four weeks
100	SEEKREAS	ENOLWM	Reasons for not seeking work
101	SEEKTYPE	ETYMP	Type of employment sought (or found)
102	SEEKDUR	ELKTIMR	Duration of search for employment
103	METHODA	EMETH1R	Whether contacted public employment office to find work
104	METHODB	EMETH2R	Whether contacted private employment office to find work
105	METHODC	EMETH3R	Whether applied to employers directly
106	METHODD	EMETH4R	Whether asked friends, relatives, trade unions etc
107	METHODE	EMETH5R	Whether inserted or answered advertisements in newspapers or journals
108	METHODF	EMETH6R	Whether studied advertisements in newspapers or journals
109	METHODG	EMETH7R	Whether took a test, interview or examination
110	METHODH	EMETH8R	Whether looked for land, premises or equipment
111	METHODI	EMETH9R	Whether looked for permits, licences or financial resources
112	METHODJ	EMETH10R	Awaiting the results of an application for a job
113	METHODK	EMETH11R	Waiting for a call from a public employment office
114	METHODL	EMETH12R	Awaiting the results of a competition for recruitment to the public sector
115	METHODM	EMETH13R	Other method used
116	WANTWORK	ELIKWKR	Willingness to work for person not seeking employment
117	AVAILBLE	EAVLWKR	Availability to start working within two weeks
118	AVAIAREAS	EAVLREA	Reasons for not being available to start working within two weeks
119	PRESEEK	EBEFORER	Situation immediately before person started to seek employment
120	NEEDCARE	ENECARE	Need for care facilities
121	REGISTER	EREGPUB	Registration at a public employment office
122	MAINSTAT	ESTATUS	Main labour status
123	EDUCSTAT	EDUCSTA	Student or apprentice in regular education during the last four weeks
124	EDUCLEVL	EDUCLEV	Level of this education or training
125-127	EDUCFILD	EDUCFLD	Field of this education or training
128	COURATT	ECOURA	Attendance at courses, seminars etc outside regular education system
129-131	COURLEN	ECOURL	Number of hours spent on all taught-learning activities within last four weeks
132	COURPURP	ECOURP	Purpose of most recent taught-learning activity
133-135	COURFILD	ECOURF	Field of most recent taught-learning activity
136	COURWORH	ECOURW	Whether most recent taught-learning took place during paid working hours
137-138	HATLEVEL	EHATLEV	Highest level of education or training successfully completed
139-141	HATFIELD	EHATFLD	Field of highest level of education or training successfully completed
142-145	HATYEAR	EHATYR	Year when highest level of education or training was successfully completed
146	WSTAT1Y	ESITONE	Situation regarding activity one year ago
147	STAPRO1Y	ESTATOR	Professional status one year ago
148-149	NACE1Y2D	ENACEO08	Economic activity of local unit in which respondent employed one year ago
150-151	COUNTRY1Y	ECTYO	Country of residence one year ago
152-153	REGION1Y	EREGO10	Region of residence one year ago – NUTS10 level 2
154-155	INCDECIL	ENETMN	Monthly (take-home) pay from main job

Eurostat variable names and their UK LFS equivalents (2012 to 2013) cont'd

Col	Eurostat name	LFS name	Description
156-159	REFYEAR	EYEAR	Year of survey
160-161	REFWEEK	EREFWK	Reference week
162-163	INTWEEK	EINTWK	Interview week
164-165	COUNTRY	ESTATE	Country
166-167	REGION	EREGN10	Region of household – NUTS10 level 2
168	DEGURBA	EURBAN	Degree of urbanisation
169-174	HHNUM	ESERIAL	Serial number of household
175	HHTYPE	ETYPHLD	Type of household
176	HHINST	ETYPINS	Type of institution
177-182	COEFFY	EWEIGHT	Weight, yearly
183-188	COEFFQ	EQWTyy	Weight, quarterly
189-194	COEFFH	EQHHWT	Weight, yearly household
195	INTWAVE	EWAVE	Sequence number of the survey wave
196	INTQUEST	EINTQUES	Questionnaire used
260-262	REG3DW	EREGWK103	Region of place of work – NUTS10 level 3 (optional)
263-265	REG3D1Y	EREGO103	Region of residence one year ago – NUTS10 level 3 (optional)
266-268	REG3D	EREGN103	Region of residence – NUTS10 level 3 (optional)

Annex IV (b) – Eurostat variable names and their UK LFS equivalents (2014)

The UK LFS historically has tended to rename Eurostat variables. Generally this involves adding an ‘E’ prefix and truncating the Eurostat name, for example COBFATH (country of birth of father) becomes ECOBFAT.

Col	Eurostat name	LFS name	Description
1-2	HHSEQNUM	EPERSNO	Person number within household
3	HHLINK	ERELHOH	Relationship to head of household
4-5	HHSPOU	ESPOUSE	Sequence number of spouse or partner
6-7	HHFATH	EFATHER	Sequence number of father
8-9	HHMOTH	EMOTHER	Sequence number of mother
10	SEX	ESEX	Sex
11-14	YEARBIR	EYOB	Year of birth
15	DATEBIR	EDOB	Date of birth in relation to end of ref period
16	MARSTAT	EMARSTAT	Marital status
17-18	NATIONAL	ENAT	Nationality
19-20	REARESID	EYRSRES	Years of residence
21-22	COUNTRYB	ECOB	Country of birth
23	PROXY	EPROXY	Nature of participation in survey
24	WSTATOR	EWKSTATR	Work status in ref week
25-26	NOWKREAS	ERESAWYR	Reason for not working but having job
27	STAPRO	ESTATR	Professional status
28	SIGNISAL	EFISAL	Continuing receipt of wage or salary
29-31	NACE3D	ENACE08	Industry / Economic activity of local unit
32-35	ISCO4D	EISCOMR	Occupation
36	SUPVISOR	ESUPVIS	Supervisory responsibilities
37-38	SIZEFIRM	ENUMPR	Number of persons working at the local unit / establishment
39-40	COUNTRYW	ECONWRK	Country of place of work
41-42	REGIONW	EREGWK10	Region of place of work – NUTS10 level 2
43-46	YSTARTWK	EYRSTRTR	Year started with current employer or as self employed
47-48	MSTARTWK	EMNSTRTR	Month started with current employer or as self employed
49	WAYJFOUN	EHOWGET	Involvement of public employment office in job find
50	FTPT	EFTPTWKR	Full, part-time distinction (main job)
51	FTPTREAS	EYPTJOB	Reasons for part-time work
52	TEMP	EPERM	Permanency of main job
53	TEMPREAS	EWHYTMP	Reasons for having a temporary job / work contract of limited duration
54	TEMPDUR	EDURTMPR	Total duration of temporary job
55	TEMPAGCY	ETMPCON	Contract with a temporary employment agency
56	SHIFTWK	ESHIFTR	Shiftwork (in main job)
57	EVENWK	EEVENR	Evening work (in main job)
58	NIGHTWK	ENIGHTR	Night work (in main job)
59	SATWK	ESATR	Saturday work (in main job)
60	SUNWK	ESUNR	Sunday work (in main job)
61-62	HWUSUAL	EUSUHRR	Number of hours per week usually worked
63-64	HWACTUAL	EACTHRR	Number of hours actually worked during reference week
65-66	HWOVERP	EACTPOT	Whether did paid overtime during reference week (in main job)
67-68	HWOVERPU	EACTUOT	Whether did unpaid overtime during reference week (in main job)
69-70	HOURREAS	EWHYDIFR	Main reason actual hours differ from usual hours
71	WISHMORE	EMHRSR	Wish to work usually more than current number of hours
72	WAYMORE	EWAYHRS	Way in which want to work more hours
73-74	HWWISH	ENUMHRSR	Total number of hours respondent would like to work.
75	HOMEWK	EHOMER	Whether works at home
76	LOOKOJ	EADDWKR	Whether looking for another job

Eurostat variable names and their UK LFS equivalents (2014) cont'd

Col	Eurostat name	LFS name	Description
77	LOOKREAS	EADDREA	Reason for looking for another job
78	EXIST2J	ESECJOBR	Existence of more than one job or business
79	STAPRO2J	ESTAT2R	Professional status in second job
80-81	NACE2J2D	ENACE208	Economic activity of the local unit (in second job)
82-83	HWACTUA2	EACTHR2R	Number of hours actually worked during reference week in second job
84	EXISTPR	EEVWKR	Existence of previous employment experience
85-88	YEARPR	EYRLASTR	Year in which respondent last worked
89-90	MONTHPR	EMNLASTR	Month in which respondent last worked
91-92	LEAVRS	EWHYLFTR	Main reason for leaving last job or business
93	STAPROPR	ESTATLR	Professional status in last job
94-95	NACEPR2D	ENACEL08	Economic activity of the local unit in which respondent last worked
96-98	ISCOPR3D	EISCOLR	Occupation of last job
99	SEEKWORK	ELOOKR	Seeking employment during previous four weeks
100	SEEKREAS	ENOLWM	Reasons for not seeking work
101	SEEKTYPE	ETYMP SR	Type of employment sought (or found)
102	SEEKDUR	ELKTIMR	Duration of search for employment
103	METHODA	EMETH1R	Whether contacted public employment office to find work
104	METHODB	EMETH2R	Whether contacted private employment office to find work
105	METHODC	EMETH3R	Whether applied to employers directly
106	METHODD	EMETH4R	Whether asked friends, relatives, trade unions etc
107	METHODE	EMETH5R	Whether inserted or answered advertisements in newspapers or journals
108	METHODF	EMETH6R	Whether studied advertisements in newspapers or journals
109	METHODG	EMETH7R	Whether took a test, interview or examination
110	METHODH	EMETH8R	Whether looked for land, premises or equipment
111	METHODI	EMETH9R	Whether looked for permits, licences or financial resources
112	METHODJ	EMETH10R	Awaiting the results of an application for a job
113	METHODK	EMETH11R	Waiting for a call from a public employment office
114	METHODL	EMETH12R	Awaiting the results of a competition for recruitment to the public sector
115	METHODM	EMETH13R	Other method used
116	WANTWORK	ELIKWKR	Willingness to work for person not seeking employment
117	AVAILBLE	EAVLWKR	Availability to start working within two weeks
118	AVAIAREAS	EAVLREA	Reasons for not being available to start working within two weeks
119	PRESEEK	EBEFORER	Situation immediately before person started to seek employment
120	NEEDCARE	ENECARE	Need for care facilities
121	REGISTER	EREGPUB	Registration at a public employment office
122	MAINSTAT	ESTATUS	Main labour status
123	EDUCSTAT	EDUCSTA	Student or apprentice in regular education during the last four weeks
124	-	(Blank)	(Formerly EDUCLEVL, see 209)
125-127	-	(Blank)	(Formerly EDUCFILD, discontinued 2014)
128	COURATT	ECOURA	Attendance at courses, seminars etc outside regular education system
129-131	COURLEN	ECOURL	Number of hours spent on all taught-learning activities within last four weeks
132	COURPURP	ECOURP	Purpose of most recent taught-learning activity
133-135	COURFILD	ECOURF	Field of most recent taught-learning activity
136	COURWORH	ECOURW	Whether most recent taught-learning took place during paid working hours
137-138	-	(Blank)	(Formerly HATLEVEL, see 197-199)
139-141	-	(Blank)	(Formerly HATFIELD, see 205-208)
142-145	-	(Blank)	(Formerly HATYEAR, see 200-203)
146	WSTAT1Y	ESITONE	Situation regarding activity one year ago
147	STAPRO1Y	ESTATOR	Professional status one year ago
148-149	NACE1Y2D	ENACEO08	Economic activity of local unit in which respondent employed one year ago
150-151	COUNTRY1Y	ECTYO	Country of residence one year ago
152-153	REGION1Y	EREGO10	Region of residence one year ago – NUTS10 level 2
154-155	INCDECIL	ENETMN	Monthly (take-home) pay from main job

Eurostat variable names and their UK LFS equivalents (2014) cont'd

Col	Eurostat name	LFS name	Description
156-159	REFYEAR	EYEAR	Year of survey
160-161	REFWEEK	EREFWK	Reference week
162-163	INTWEEK	EINTWK	Interview week
164-165	COUNTRY	ESTATE	Country
166-167	REGION	EREGN10	Region of household – NUTS10 level 2
168	DEGURBA	EURBAN	Degree of urbanisation
169-174	HHNUM	ESERIAL	Serial number of household
175	HHTYPE	ETYPHLD	Type of household
176	HHINST	ETYPINS	Type of institution
177-182	COEFFY	EWEIGHT	Weight, yearly
183-188	COEFFQ	EQWTyy	Weight, quarterly
189-194	COEFFH	EQHHWT	Weight, yearly household
195	INTWAVE	EWAVE	Sequence number of the survey wave
196	INTQUEST	EINTQUES	Questionnaire used
197-199	HATLEVEL	EHATLEV14	Educational attainment level
200-203	HATYEAR	EHATYR14	Year when highest level of education completed
204	HATVOC	EHATVOC14	Orientation of programme completed at highest level (i.e. HATLEVEL)
205-208	HATFIELD	EHATFLD14	Field of programme completed at highest level (i.e. HATLEVEL)
209	EDUCLEVL	EDUCLEV14	Level of current education in which person enrolled
210	EDUCVOC	EDUCVOC14	Orientation of programme on which person enrolled (i.e. EDUCLEVL)
260-262	REG3DW	EREGWK103	Region of place of work – NUTS10 level 3 (optional)
263-265	REG3D1Y	EREGO103	Region of residence one year ago – NUTS10 level 3 (optional)
266-268	REG3D	EREGN103	Region of residence – NUTS10 level 3 (optional)

Annex IV © – Eurostat variable names and their UK LFS equivalents (2015)

The UK LFS historically has tended to rename Eurostat variables. Generally this involves adding an ‘E’ prefix and truncating the Eurostat name, for example COBFATH (country of birth of father) becomes ECOBFAT.

Col	Eurostat name	LFS name	Description
1-2	HHSEQNUM	EPERSNO	Person number within household
3	HHLINK	ERELHOH	Relationship to head of household
4-5	HHSPOU	ESPOUSE	Sequence number of spouse or partner
6-7	HHFATH	EFATHER	Sequence number of father
8-9	HHMOTH	EMOTHER	Sequence number of mother
10	SEX	ESEX	Sex
11-14	YEARBIR	EYOB	Year of birth
15	DATEBIR	EDOB	Date of birth in relation to end of ref period
16	MARSTAT	EMARSTAT	Marital status
17-18	NATIONAL	ENAT	Nationality
19-20	REARESID	EYRSRES	Years of residence
21-22	COUNTRYB	ECOB	Country of birth
23	PROXY	EPROXY	Nature of participation in survey
24	WSTATOR	EWKSTATR	Work status in ref week
25-26	NOWKREAS	ERESAWYR	Reason for not working but having job
27	STAPRO	ESTATR	Professional status
28	SIGNISAL	EFISAL	Continuing receipt of wage or salary
29-31	NACE3D	ENACE08	Industry / Economic activity of local unit
32-35	ISCO4D	EISCOMR	Occupation
36	SUPVISOR	ESUPVIS	Supervisory responsibilities
37-38	SIZEFIRM	ENUMPR	Number of persons working at the local unit / establishment
39-40	COUNTRYW	ECONWRK	Country of place of work
41-42	REGIONW	EREGWK13	Region of place of work – NUTS13 level 2
43-46	YSTARTWK	EYRSTRTR	Year started with current employer or as self employed
47-48	MSTARTWK	EMNSTRTR	Month started with current employer or as self employed
49	WAYJFOUN	EHOWGET	Involvement of public employment office in job find
50	FTPT	EFTPTWKR	Full, part-time distinction (main job)
51	FTPTREAS	EYPTJOB	Reasons for part-time work
52	TEMP	EPERM	Permanency of main job
53	TEMPREAS	EWHYTMP	Reasons for having a temporary job / work contract of limited duration
54	TEMPDUR	EDURTMPR	Total duration of temporary job
55	TEMPAGCY	ETMPCON	Contract with a temporary employment agency
56	SHIFTWK	ESHIFTR	Shiftwork (in main job)
57	EVENWK	EEVENR	Evening work (in main job)
58	NIGHTWK	ENIGHTR	Night work (in main job)
59	SATWK	ESATR	Saturday work (in main job)
60	SUNWK	ESUNR	Sunday work (in main job)
61-62	HWUSUAL	EUSUHRR	Number of hours per week usually worked
63-64	HWACTUAL	EACTHRR	Number of hours actually worked during reference week
65-66	HWOVERP	EACTPOT	Whether did paid overtime during reference week (in main job)
67-68	HWOVERPU	EACTUOT	Whether did unpaid overtime during reference week (in main job)
69-70	HOURREAS	EWHYDIFR	Main reason actual hours differ from usual hours
71	WISHMORE	EMHRSR	Wish to work usually more than current number of hours
72	WAYMORE	EWAYHRS	Way in which want to work more hours
73-74	HWWISH	ENUMHRSR	Total number of hours respondent would like to work.
75	HOMEWK	EHOMER	Whether works at home
76	LOOKOJ	EADDWKR	Whether looking for another job

Eurostat variable names and their UK LFS equivalents (2015) cont'd

Col	Eurostat name	LFS name	Description
77	LOOKREAS	EADDRESS	Reason for looking for another job
78	EXIST2J	ESECJOBR	Existence of more than one job or business
79	STAPRO2J	ESTAT2R	Professional status in second job
80-81	NACE2J2D	ENACE208	Economic activity of the local unit (in second job)
82-83	HWACTUA2	EACTHR2R	Number of hours actually worked during reference week in second job
84	EXISTPR	EEVWKR	Existence of previous employment experience
85-88	YEARPR	EYRLASTR	Year in which respondent last worked
89-90	MONTHPR	EMNLASTR	Month in which respondent last worked
91-92	LEAVRS	EWHYLFTR	Main reason for leaving last job or business
93	STAPROPR	ESTATLR	Professional status in last job
94-95	NACEPR2D	ENACEL08	Economic activity of the local unit in which respondent last worked
96-98	ISCOPR3D	EISCOLR	Occupation of last job
99	SEEKWORK	ELOOKR	Seeking employment during previous four weeks
100	SEEKREAS	ENOLWM	Reasons for not seeking work
101	SEEKTYPE	ETYMP SR	Type of employment sought (or found)
102	SEEKDUR	ELKTIMR	Duration of search for employment
103	METHODA	EMETH1R	Whether contacted public employment office to find work
104	METHODB	EMETH2R	Whether contacted private employment office to find work
105	METHODC	EMETH3R	Whether applied to employers directly
106	METHODD	EMETH4R	Whether asked friends, relatives, trade unions etc
107	METHODE	EMETH5R	Whether inserted or answered advertisements in newspapers or journals
108	METHODF	EMETH6R	Whether studied advertisements in newspapers or journals
109	METHODG	EMETH7R	Whether took a test, interview or examination
110	METHODH	EMETH8R	Whether looked for land, premises or equipment
111	METHODI	EMETH9R	Whether looked for permits, licences or financial resources
112	METHODJ	EMETH10R	Awaiting the results of an application for a job
113	METHODK	EMETH11R	Waiting for a call from a public employment office
114	METHODL	EMETH12R	Awaiting the results of a competition for recruitment to the public sector
115	METHODM	EMETH13R	Other method used
116	WANTWORK	ELIKWKR	Willingness to work for person not seeking employment
117	AVAILBLE	EAVLWKR	Availability to start working within two weeks
118	AVAIAREAS	EAVLREA	Reasons for not being available to start working within two weeks
119	PRESEEK	EBEFORER	Situation immediately before person started to seek employment
120	NEEDCARE	ENECARE	Need for care facilities
121	REGISTER	EREGPUB	Registration at a public employment office
122	MAINSTAT	ESTATUS	Main labour status
123	EDUCSTAT	EDUCSTA	Student or apprentice in regular education during the last four weeks
124	-	(Blank)	(Formerly EDUCLEVL, see 209)
125-127	-	(Blank)	(Formerly EDUCFILD, discontinued 2014)
128	COURATT	ECOURA	Attendance at courses, seminars etc outside regular education system
129-131	COURLEN	ECOURL	Number of hours spent on all taught-learning activities within last four weeks
132	COURPURP	ECOURP	Purpose of most recent taught-learning activity
133-135	COURFILD	ECOURF	Field of most recent taught-learning activity
136	COURWORH	ECOURW	Whether most recent taught-learning took place during paid working hours
137-138	-	(Blank)	(Formerly HATLEVEL, see 197-199)
139-141	-	(Blank)	(Formerly HATFIELD, see 205-208)
142-145	-	(Blank)	(Formerly HATYEAR, see 200-203)
146	WSTAT1Y	ESITONE	Situation regarding activity one year ago
147	STAPRO1Y	ESTATOR	Professional status one year ago
148-149	NACE1Y2D	ENACEO08	Economic activity of local unit in which respondent employed one year ago
150-151	COUNTRY1Y	ECTYO	Country of residence one year ago
152-153	REGION1Y	EREGO13	Region of residence one year ago – NUTS13 level 2
154-155	INCDECIL	ENETMN	Monthly (take-home) pay from main job

Eurostat variable names and their UK LFS equivalents (2015) cont'd

Col	Eurostat name	LFS name	Description
156-159	REFYEAR	EYEAR	Year of survey
160-161	REFWEEK	EREFWK	Reference week
162-163	INTWEEK	EINTWK	Interview week
164-165	COUNTRY	ESTATE	Country
166-167	REGION	EREGN13	Region of household – NUTS13 level 2
168	DEGURBA	EURBAN	Degree of urbanisation
169-174	HHNUM	ESERIAL	Serial number of household
175	HHTYPE	ETYPHLD	Type of household
176	HHINST	ETYPINS	Type of institution
177-182	COEFFY	EWEIGHT	Weight, yearly
183-188	COEFFQ	EQWTyy	Weight, quarterly
189-194	COEFFH	EQHHWT	Weight, yearly household
195	INTWAVE	EWAVE	Sequence number of the survey wave
196	INTQUEST	EINTQUES	Questionnaire used
197-199	HATLEVEL	EHATLEV15	Educational attainment level
200-203	HATYEAR	EHATYR15	Year when highest level of education completed
204	HATVOC	EHATVOC15	Orientation of programme completed at highest level (i.e. HATLEVEL)
205-208	HATFIELD	EHATFLD15	Field of programme completed at highest level (i.e. HATLEVEL)
209	EDUCLEVL	EDUCLEV15	Level of current education in which person enrolled
210	EDUCVOC	EDUCVOC15	Orientation of programme on which person enrolled (i.e. EDUCLEVL)
260-262	REG3DW	EREGWK133	Region of place of work – NUTS13 level 3 (optional)
263-265	REG3D1Y	EREGO133	Region of residence one year ago – NUTS13 level 3 (optional)
266-268	REG3D	EREGN133	Region of residence – NUTS13 level 3 (optional)

Annex IV (d) – Eurostat variable names and their UK LFS equivalents (2016)

The UK LFS historically has tended to rename Eurostat variables. Generally this involves adding an ‘E’ prefix and truncating the Eurostat name, for example COBFATH (country of birth of father) becomes ECOBFAT.

Col	Eurostat name	LFS name	Description
1-2	HHSEQNUM	EPERSNO	Person number within household
3	HHLINK	ERELHOH	Relationship to head of household
4-5	HHSPOU	ESPOUSE	Sequence number of spouse or partner
6-7	HHFATH	EFATHER	Sequence number of father
8-9	HHMOTH	EMOTHER	Sequence number of mother
10	SEX	ESEX	Sex
11-14	YEARBIR	EYOB	Year of birth
15	DATEBIR	EDOB	Date of birth in relation to end of ref period
16	MARSTAT	EMARSTAT	Marital status
17-18	NATIONAL	ENAT	Nationality
19-20	REARESID	EYRSRES	Years of residence
21-22	COUNTRYB	ECOB	Country of birth
23	PROXY	EPROXY	Nature of participation in survey
24	WSTATOR	EWKSTATR	Work status in ref week
25-26	NOWKREAS	ERESAWYR	Reason for not working but having job
27	STAPRO	ESTATR	Professional status
28	SIGNISAL	EFISAL	Continuing receipt of wage or salary
29-31	NACE3D	ENACE08	Industry / Economic activity of local unit
32-35	ISCO4D	EISCOMR	Occupation
36	SUPVISOR	ESUPVIS	Supervisory responsibilities
37-38	SIZEFIRM	ENUMPR	Number of persons working at the local unit / establishment
39-40	COUNTRYW	ECONWRK	Country of place of work
41-42	REGIONW	EREGWKR	Region of place of work
43-46	YSTARTWK	EYRSTRTR	Year started with current employer or as self employed
47-48	MSTARTWK	EMNSTRTR	Month started with current employer or as self employed
49	WAYJFOUN	EHOWGET	Involvement of public employment office in job find
50	FTPT	EFTPTWKR	Full, part-time distinction (main job)
51	FTPTREAS	EYPTJOB	Reasons for part-time work
52	TEMP	EPERM	Permanency of main job
53	TEMPREAS	EWHYTMP	Reasons for having a temporary job / work contract of limited duration
54	TEMPDUR	EDURTMPR	Total duration of temporary job
55	TEMPAGCY	ETMPCON	Contract with a temporary employment agency
56	SHIFTWK	ESHIFTR	Shiftwork (in main job)
57	EVENWK	EEVENR	Evening work (in main job)
58	NIGHTWK	ENIGHTR	Night work (in main job)
59	SATWK	ESATR	Saturday work (in main job)
60	SUNWK	ESUNR	Sunday work (in main job)
61-62	HWUSUAL	EUSUHRR	Number of hours per week usually worked
63-64	HWACTUAL	EACTHRR	Number of hours actually worked during reference week
65-66	HWOVERP	EACTPOT	Whether did paid overtime during reference week (in main job)
67-68	HWOVERPU	EACTUOT	Whether did unpaid overtime during reference week (in main job)
69-70	HOURREAS	EWHYDIFR	Main reason actual hours differ from usual hours
71	WISHMORE	EMHRSR	Wish to work usually more than current number of hours
72	WAYMORE	EWAYHRS	Way in which want to work more hours
73-74	HWWISH	ENUMHRSR	Total number of hours respondent would like to work.
75	HOMEWK	EHOMER	Whether works at home
76	LOOKOJ	EADDWKR	Whether looking for another job

Eurostat variable names and their UK LFS equivalents (2016) cont'd

Col	Eurostat name	LFS name	Description
77	LOOKREAS	EADDREA	Reason for looking for another job
78	EXIST2J	ESECJOBR	Existence of more than one job or business
79	STAPRO2J	ESTAT2R	Professional status in second job
80-81	NACE2J2D	ENACE208	Economic activity of the local unit (in second job)
82-83	HWACTUA2	EACTHR2R	Number of hours actually worked during reference week in second job
84	EXISTPR	EEVWKR	Existence of previous employment experience
85-88	YEARPR	EYRLASTR	Year in which respondent last worked
89-90	MONTHPR	EMNLASTR	Month in which respondent last worked
91-92	LEAVRS	EWHYLFTR	Main reason for leaving last job or business
93	STAPROPR	ESTATLR	Professional status in last job
94-95	NACEPR2D	ENACEL08	Economic activity of the local unit in which respondent last worked
96-98	ISCOPR3D	EISCOLR	Occupation of last job
99	SEEKWORK	ELOOKR	Seeking employment during previous four weeks
100	SEEKREAS	ENOLWM	Reasons for not seeking work
101	SEEKTYPE	ETYMPSR	Type of employment sought (or found)
102	SEEKDUR	ELKTIMR	Duration of search for employment
103	METHODA	EMETH1R	Whether contacted public employment office to find work
104	METHODB	EMETH2R	Whether contacted private employment office to find work
105	METHODC	EMETH3R	Whether applied to employers directly
106	METHODD	EMETH4R	Whether asked friends, relatives, trade unions etc
107	METHODE	EMETH5R	Whether inserted or answered advertisements in newspapers or journals
108	METHODF	EMETH6R	Whether studied advertisements in newspapers or journals
109	METHODG	EMETH7R	Whether took a test, interview or examination
110	METHODH	EMETH8R	Whether looked for land, premises or equipment
111	METHODI	EMETH9R	Whether looked for permits, licences or financial resources
112	METHODJ	EMETH10R	Awaiting the results of an application for a job
113	METHODK	EMETH11R	Waiting for a call from a public employment office
114	METHODL	EMETH12R	Awaiting the results of a competition for recruitment to the public sector
115	METHODM	EMETH13R	Other method used
116	WANTWORK	ELIKWKR	Willingness to work for person not seeking employment
117	AVAILBLE	EAVALWKR	Availability to start working within two weeks
118	AVAIRES	EAVALREA	Reasons for not being available to start working within two weeks
119	PRESEEK	EBEFORER	Situation immediately before person started to seek employment
120	NEEDCARE	ENECARE	Need for care facilities
121	REGISTER	EREGPUB	Registration at a public employment office
122	MAINSTAT	ESTATUS	Main labour status
123	EDUCSTAT	EDUCSTA16	Student or apprentice in regular education during the last four weeks
124	-	(Blank)	(Formerly EDUCLEVL, see 209)
125-127	-	(Blank)	(Formerly EDUCFILD, discontinued 2014)
128	COURATT	ECOURA16	Attendance at courses, seminars etc outside regular education system
129-131	COURLEN	ECOURL	Number of hours spent on all taught-learning activities within last 4 weeks
132	COURPURP	ECOURP	Purpose of most recent taught-learning activity
133-135	COURFILD	ECOURF16	Field of most recent taught-learning activity
136	COURWORH	ECOURW	Whether most recent taught-learning took place during paid working hours
137-138	-	(Blank)	(Formerly HATLEVEL, see 197-199)
139-141	-	(Blank)	(Formerly HATFIELD, see 205-208)
142-145	-	(Blank)	(Formerly HATYEAR, see 200-203)
146	WSTAT1Y	ESITONE	Situation regarding activity one year ago
147	STAPRO1Y	ESTATOR	Professional status one year ago
148-149	NACE1Y2D	ENACEO08	Economic activity of local unit in which respondent employed one year ago
150-151	COUNTRY1Y	ECTYO	Country of residence one year ago
152-153	REGION1Y	EREGO00	Region of residence one year ago
154-155	INCDECIL	ENETMN	Monthly (take-home) pay from main job

Eurostat variable names and their UK LFS equivalents (2016) cont'd

Col	Eurostat name	LFS name	Description
156-159	REFYEAR	EYEAR	Year of survey
160-161	REFWEEK	EREFWK	Reference week
162-163	INTWEEK	EINTWK	Interview week
164-165	COUNTRY	ESTATE	Country
166-167	REGION	EREGN00	Region of household
168	DEGURBA	EURBAN	Degree of urbanisation
169-174	HHNUM	ESERIAL	Serial number of household
175	HHTYPE	ETYPHLD	Type of household
176	HHINST	ETYPINS	Type of institution
177-182	COEFFY	EWEIGHT	Weight, yearly
183-188	COEFFQ	EQWTyy	Weight, quarterly
189-194	COEFFH	EQHHWT	Weight, yearly household
195	INTWAVE	EWAVE	Sequence number of the survey wave
196	INTQUEST	EINTQUES	Questionnaire used
197-199	HATLEVEL	EHATLEV15	Educational attainment level
200-203	HATYEAR	EHATYR15	Year when highest level of education completed
204	HATVOC	EHATVOC15	Orientation of programme completed at highest level (i.e. HATLEVEL)
205-208	HATFIELD	EHATFLD16	Field of programme completed at highest level (i.e. HATLEVEL)
209	EDUCLEVL	EDUCLEV16	Level of current education in which person enrolled
210	EDUCVOC	EDUCVOC15	Orientation of programme on which person enrolled (i.e. EDUCLEVL)
260-262	REG3DW	EREGWK133	Region of place of work – NUTS13 level 3 (optional)
263-265	REG3D1Y	EREGO133	Region of residence one year ago – NUTS13 level 3 (optional)
266-268	REG3D	EREGN133	Region of residence – NUTS13 level 3 (optional)

INDEX OF EU-LFS VARIABLES FLOWCHARTS

Col	Eurostat name	LFS name	Description	Period	Page No.
1-2	HHSEQNUM	EPERSNO	Person number within household	All	104
3	HHLINK	ERELHOH	Relationship to head of household	All	105
4-5	HHSPOU	ESPOUSE	Sequence number of spouse or partner	All	107
6-7	HHFATH	EFATHER	Sequence number of father	All	109
8-9	HHMOTH	EMOTHER	Sequence number of mother	All	110
10	SEX	ESEX	Sex	All	111
11-14	YEARBIR	EYOB	Year of birth	All	112
15	DATEBIR	EDOB	Date of birth in relation to end of ref period	All	113
16	MARSTAT	EMARSTAT	Marital status	All	114
17-18	NATIONAL	ENAT	Nationality	All	115
19-20	YEARESID	EYRSRES	Years of residence	All	122
21-22	COUNTRYB	ECOB	Country of birth	All	124
23	PROXY	EPROXY	Nature of participation in survey	All	131
24	WSTATOR	EWKSTATR	Work status in ref week	All	132
25-26	NOWKREAS	ERESAWYR	Reason for not working but having job	All	134
27	STAPRO	ESTATR	Professional status	All	136
28	SIGNISAL	EFISAL	Continuing receipt of wage or salary	All	137
29-31	NACE3D	ENACE08	Industry / Economic activity of local unit	All	138
32-35	ISCO4D	EISCOMR	Occupation	-2010	139
32-35	ISCO4D	EISCOMR(15)	Occupation	2011-	393
36	SUPVISOR	ESUPVIS	Supervisory responsibilities	All	142
37-38	SIZEFIRM	ENUMPR	Number of persons working at the local unit / establishment	All	143
39-40	COUNTRYW	ECONWRK	Country of place of work	All	144
41-42	REGIONW	EREGWKR	Region of place of work	All	151
43-46	YSTARTWK	EYRSTRTR	Year started with current employer or as self employed	All	156
47-48	MSTARTWK	EMNSTRTR	Month started with current employer or as self employed	All	157
49	WAYJFOUN	EHOWGET	Involvement of public employment office in job find	All	158
50	FTPT	EFTPTWKR	Full, part-time distinction (main job)	All	159
51	FTPTREAS	EYPTJOB	Reasons for part-time work	All	160
52	TEMP	EPERMR	Permanency of main job	All	161
53	TEMPREAS	EWHYTMP	Reasons for having a temporary job / work contract of limited duration	All	162
54	TEMPDUR	EDURTMPR	Total duration of temporary job	All	163
55	TEMPAGCY	ETMPCON	Contract with a temporary employment agency	All	164
56	SHIFTWK	ESHIFTR	Shiftwork (in main job)	All	165
57	EVENWK	EEVENR	Evening work (in main job)	All	166
58	NIGHTWK	ENIGHTR	Night work (in main job)	All	167
59	SATWK	ESATR	Saturday work (in main job)	All	168
60	SUNWK	ESUNR	Sunday work (in main job)	All	169
61-62	HWUSUAL	EUSUHR	Number of hours per week usually worked	All	170
63-64	HWACTUAL	EACTHRR	Number of hours actually worked during reference week	All	171
65-66	HWOVERP	EACTPOT	Whether did paid overtime during reference week (in main job)	All	172
67-68	HWOVERPU	EACTUOT	Whether did unpaid overtime during reference week (in main job)	All	173
69-70	HOURREAS	EWHYDIFR	Main reason actual hours differ from usual hours	All	174
71	WISHMORE	EMHRSR	Wish to work usually more than current number of hours	All	176
72	WAYMORE	EWAYHRS	Way in which want to work more hours	All	177
73-74	HWWISH	ENUMHRSR	Total number of hours respondent would like to work.	All	178
75	HOMEWK	EHOMER	Whether works at home	All	179
76	LOOKOJ	EADDWKR	Whether looking for another job	All	180
77	LOOKREAS	EADDREA	Reason for looking for another job	All	181
78	EXIST2J	ESECJOBR	Existence of more than one job or business	All	182
79	STAPRO2J	ESTAT2R	Professional status in second job	All	183
80-81	NACE2J2D	ENACE208	Economic activity of the local unit (in second job)	All	184
82-83	HWACTUA2	EACTHR2R	Number of hours actually worked during reference week in second job	All	185
84	EXISTPR	EEVWKR	Existence of previous employment experience	All	186
85-88	YEARPR	EYRLASTR	Year in which respondent last worked	All	187
89-90	MONTHPR	EMNLASTR	Month in which respondent last worked	All	188

Col	Eurostat name	LFS name	Description	Period	Page No.
91-92	LEAVRS	EWHYLFTR	Main reason for leaving last job or business	All	189
93	STAPROPR	ESTATLR	Professional status in last job	All	190
94-95	NACEPR2D	ENACEL08	Economic activity of the local unit in which respondent last worked	All	191
96-98	ISCOPR3D	EISCOLR	Occupation of last job	All	192
99	SEEKWORK	ELOOKR	Seeking employment during previous four weeks	All	193
100	SEEKREAS	ENOLWM	Reasons for not seeking work	All	194
101	SEEKTYPE	ETYMPSR	Type of employment sought (or found)	All	195
102	SEEKDUR	ELKTIMR	Duration of search for employment	All	197
103	METHODA	EMETH1R	Whether contacted public employment office to find work	All	199
104	METHODB	EMETH2R	Whether contacted private employment office to find work	All	200
105	METHODC	EMETH3R	Whether applied to employers directly	All	201
106	METHODD	EMETH4R	Whether asked friends, relatives, trade unions etc	All	202
107	METHODE	EMETH5R	Whether inserted or answered advertisements in newspapers or journals	All	203
108	METHODF	EMETH6R	Whether studied advertisements in newspapers or journals	All	204
109	METHODG	EMETH7R	Whether took a test, interview or examination	All	205
110	METHODH	EMETH8R	Whether looked for land, premises or equipment	All	206
111	METHODI	EMETH9R	Whether looked for permits, licences or financial resources	All	207
112	METHODJ	EMETH10R	Awaiting the results of an application for a job	All	208
113	METHODK	EMETH11R	Waiting for a call from a public employment office	All	209
114	METHODL	EMETH12R	Awaiting the results of a competition for recruitment to the public sector	All	210
115	METHODM	EMETH13R	Other method used	All	211
116	WANTWORK	ELIKWKR	Willingness to work for person not seeking employment	All	212
117	AVAILABLE	EVALWKR	Availability to start working within two weeks	All	213
118	AVAIRES	EVALREA	Reasons for not being available to start working within two weeks	All	214
119	PRESEEK	EBEFORER	Situation immediately before person started to seek employment	All	215
120	NEEDCARE	ENECARE	Need for care facilities	All	216
121	REGISTER	EREGPUB	Registration at a public employment office	All	217
122	MAINSTAT	ESTATUS	Main labour status (optional)	All	N/A
123	EDUCSTAT	EDUCSTA16	Student or apprentice in regular education during the last four weeks	All	218
124	EDUCLEVL	EDUCLEV	Level of this education or training	-2013	219
124		(Blank)	(Formerly EDUCLEVL, see 209)	2014-	-
125-127	EDUCFILD	EDUCFLD	Field of this education or training	-2013	221
125-127		(Blank)	(Formerly EDUCFILD, discontinued 2014)	2014-	-
128	COURATT	ECOURA	Attendance at courses, seminars etc outside regular education system	-2015	223
128	COURATT	ECOURA16	Attendance at courses, seminars etc outside regular education system	2016-	224
129-131	COURLEN	ECOURL	Number of hours spent on all taught-learning activities in last four weeks	-2015	225
129-131	COURLEN	ECOURL16	Number of hours spent on all taught-learning activities in last four weeks	2016-	226
132	COURPURP	ECOURP	Purpose of most recent taught-learning activity	-2015	227
132	COURPURP	ECOURP16	Purpose of most recent taught-learning activity	2016-	228
133-135	COURFILD	ECOURF	Field of most recent taught-learning activity	-2015	229
133-135	COURFILD	ECOURF16	Field of most recent taught-learning activity	2016-	231
136	COURWORH	ECOURW	Whether most recent taught-learning took place during paid working hours	-2015	232
136	COURWORH	ECOURW16	Whether most recent taught-learning took place during paid working hours	2016-	233
137-138	HATLEVEL	EHATLEV	Highest level of education or training successfully completed	-2013	234
137-138		(Blank)	(Formerly HATLEVEL, see 197-199)	2014-	-
139-141	HATFIELD	EHATFLD	Field of highest level of education or training successfully completed	-2013	235
139-141		(Blank)	(Formerly HATFIELD, see 205-208)	2014-	-
142-145	HATYEAR	EHATYR	Year when highest level of education or training completed	-2013	237
142-145		(Blank)	(Formerly HATYEAR, see 200-203)	2014-	-
146	WSTAT1Y	ESITONE	Situation regarding activity one year ago	All	238
147	STAPRO1Y	ESTATOR	Professional status one year ago	All	239
148-149	NACE1Y2D	ENACEO08	Economic activity of local unit in which respondent employed one year ago	All	240
150-151	COUNTRY1Y	ECTYO	Country of residence one year ago	All	241
152-153	REGION1Y	EREGO00	Region of residence one year ago	All	256
154-155	INCDECIL	ENETMN	Monthly (take-home) pay from main job	All	257
156-159	REFYEAR	EYEAR	Year of survey	All	272
160-161	REFWEEK	EREFWK	Reference week	All	273
162-163	INTWEEK	EINTWK	Interview week	All	274

Col	Eurostat name	LFS name	Description	Period	Page No.
164-165	COUNTRY	ESTATE	Country	All	275
166-167	REGION	EREGN00	Region of household	All	276
168	DEGURBA	EURBAN	Degree of urbanisation	All	277
169-174	HHNUM	ESERIAL	Serial number of household	All	290
175	HHTYPE	ETYPHLD	Type of household	All	291
176	HHINST	ETYPINS	Type of institution	All	292
177-182	COEFFY	EWEIGHT	Weight, yearly	All	294
183-188	COEFFQ	EQWTyy	Weight, quarterly	All	295
189-194	COEFFH	EQHHWT	Weight, yearly household	All	296
195	INTWAVE	EWAVE	Sequence number of the survey wave	All	297
196	INTQUEST	EINTQUES	Questionnaire used	All	298
197-199	HATLEVEL	EHATLEV14	Educational attainment level	2014	299
197-199	HATLEVEL	EHATLEV15	Educational attainment level	2016-	301
200-203	HATYEAR	EHATYR14	Year when highest level of education completed	2014	303
200-203	HATYEAR	EHATYR15	Year when highest level of education completed	2015-	304
204	HATVOC	EHATVOC14	Orientation of programme completed at highest level (i.e. HATLEVEL)	2014	305
204	HATVOC	EHATVOC15	Orientation of programme completed at highest level (i.e. HATLEVEL)	2015-	306
205-208	HATFIELD	EHATFLD14	Field of programme completed at highest level (i.e. HATLEVEL)	2014	307
205-208	HATFIELD	EHATFLD15	Field of programme completed at highest level (i.e. HATLEVEL)	2015	311
205-208	HATFIELD	EHATFLD16	Field of programme completed at highest level (i.e. HATLEVEL)	2016-	315
209	EDUCLEVL	EDUCLEV14	Level of current education in which person enrolled	2014	323
209	EDUCLEVL	EDUCLEV15	Level of current education in which person enrolled	2015	325
209	EDUCLEVL	EDUCLEV16	Level of current education in which person enrolled	2016-	327
210	EDUCVOC	EDUCVOC14	Orientation of programme on which person enrolled (i.e. EDUCLEVL)	2014	335
210	EDUCVOC	EDUCVOC15	Orientation of programme on which person enrolled (i.e. EDUCLEVL)	2015-	336
260-262	REG3DW	EREGWKR03	Region of place of work (optional)		
263-265	REG3D1Y	EREGO003	Region of residence one year ago (optional)		
266-268	REG3D	EREGN03	Region of residence (optional)		