

CONTENTS

| | |
|--|------------|
| SECTION 1: INTRODUCTION TO LFS USER GUIDE VOLUME 9 (EUROSTAT) | 1 |
| SECTION 2: EUROSTAT – AN INTRODUCTION | 2 |
| EuroStat databases | 3 |
| EuroStat Publications | 4 |
| Organisation of EuroStat | 5 |
| A brief history of EuroStat | 5 |
| EuroStat Address | 6 |
| SECTION 3: LABOUR FORCE SURVEYS IN THE EUROPEAN UNION | 7 |
| The purpose of labour force surveys | 7 |
| The history of labour force surveys | 9 |
| The development of the EU Labour Force Survey | 9 |
| The organisation of the EU Labour Force Survey | 11 |
| Data Collection and diffusion of results | 11 |
| SECTION 4: TECHNICAL FEATURES OF THE EU LABOUR FORCE SURVEY | 13 |
| Field of the survey/reference period/units of measurement | 13 |
| Reliability of the results/comparability of results between countries | 14 |
| Comparability of results between successive surveys | 15 |
| Basic concepts and definitions | 16 |
| SECTION 5a: COUNCIL REGULATION 577/98 OF THE EUROPEAN UNION | 19 |
| Article 1 – Frequency of the survey | 19 |
| Article 2 – Units and scope of the survey, observation methods | 20 |
| Article 3 – Representativeness of the sample | 21 |
| Article 4 – Survey characteristics | 21 |
| Article 5 – Conduct of the survey | 24 |
| Article 6 – Transmission of results | 24 |
| Article 7 – Reports | 24 |
| Article 8 – Procedure | 25 |
| SECTION 5b: COMMISSION REGULATION 2257/2003 OF THE EUROPEAN UNION | 26 |
| SECTION 5c: COMMISSION REGULATION 430/2005 OF THE EUROPEAN UNION | 28 |
| SECTION 5d: COMMISSION REGULATION 377/2008 OF THE EUROPEAN UNION | 30 |
| SECTION 6: LABOUR FORCE SURVEY - DATA CODIFICATION 2009 | 33 |
| SECTION 7: EXPLANATORY NOTES TO THE LFS LIST OF VARIABLES | 49 |
| SECTION 8: EUROSTAT AD HOC MODULES | 90 |
| SECTION 9: EUROSTAT DERIVED VARIABLE FLOWCHARTS | 110 |
| ANNEX I: REGIONAL CODES USED IN THE EU LFS FROM 2007 | 303 |
| ANNEX II: STATISTICAL CLASSIFICATION OF ECONOMIC ACTIVITIES AT 2 AND 3 DIGITS | 309 |
| ANNEX III: INTERNATIONAL STANDARD CLASSIFICATION OF OCCUPATIONS 2, 3 AND 4 DIGITS (ISCO-88 (COM)) | 318 |
| ANNEX IV: ISO COUNTRY CLASSIFICATION IN THE LFS FROM 2009 ONWARDS | 328 |

SECTION 1: INTRODUCTION TO LFS USER GUIDE VOLUME 9 (EUROSTAT)

This volume of the LFS User Guide has been compiled in response to the increasing interest in the LFS data used by EuroStat, and in EuroStat itself. Most of the contents have been taken from EuroStat's internet web site and various publications such as *The European Union Labour Force Survey – Methods and Definitions*.

The structure of this volume is as follows.

Section 2 provides a summary of EuroStat's objective, coverage, and structure. Section 3 describes the purpose and development of an EU-wide Labour Force Survey – essentially, the pulling together of the LFS conducted in each Member State. Section 4 provides some technical detail of the EU LFS.

The latest EU LFS Regulation (No. 377/2008) implements Council Regulation No. 577/98 on the organisation of a labour force sample survey in the Community concerning the codification to be used for data transmission from 2009 onwards and the use of a sub-sample for the collection of data on structural variables. The text of these regulations is shown in Section 5.

Sections 6 and 7 compliment the fifth section. Essentially, whilst the Regulations outline the broad areas for which data are required, section 6 provide the associated data codification. This describes how the LFS database provided to EuroStat is structured in terms of database columns and the values which can be included in each column. Section 7 has the explanatory notes relating to each variable. These notes are intended to help Member States collect data which are sufficiently comparable for EuroStat's purposes. They are also useful to data analysts to see exactly what has been collected.

Each year EuroStat includes a number of variables that provide information on aspects of the labour market but which do not form part of the standard questionnaire. This set of variables, constitute an "*ad hoc* module". Section 8 explains this in more detail.

Finally, section 9 provides flowcharts which show how each of the variables supplied to EuroStat are derived from the questions actually asked in the UK LFS.

SECTION 2: EUROSTAT – AN INTRODUCTION

EuroStat - the "Statistical Office of the European Communities" was established in 1953. Its mission is *to provide the European Union with a high-quality statistical information service, by using uniform rules to collect all statistical data from the National Statistical Institutes of each of the Member States of the European Union.*

Once these data have been collected in the required form, they are consolidated and then harmonised to take into account each country's specific characteristics, so that they can be used either globally or comparatively.

This process of harmonising statistical data also extends to all the European Union's partners: members of the European Economic Area (EEA), including Switzerland, and, in a number of fields essential to an understanding of Europe's position in the world, the USA and Japan.

As with any service provider, EuroStat's prime aim is to answer requests for specific statistical information. As it is the Statistical Office of the European Communities, these requests most frequently come from the European Commission.

They are followed by 3 essential steps:

1. Validation of the statistical research itself

Together with the appropriate Directorates-General plus experts' reports and the recommendations of international organisations (e.g. UN, OECD), EuroStat prepares a statistical programme which is submitted to the European Commission's "Statistical Programme Committee". EuroStat then works with the different committees, expert groups and working groups concerned to achieve a broad consensus on the proposed new statistics.

2. Data Collection

EuroStat collects its data from the National Statistical Institutes of the countries concerned. All data are checked by EuroStat, compiled in the required form and, where applicable, harmonised with European Statistical System standards.

3. Legal base

When new statistics are adopted in the European Union, or when there is a need to harmonise statistics from Member States, the decision is taken by a Council legal act which may take one of the following 3 forms:

- regulation
- directive
- recommendation

In 2005, EuroStat had around 800 employees, including registered national experts on temporary assignment and permanent European civil servants. They are all committed to the same fundamental mission: to provide the European Union with a high-quality harmonised statistical information service, offering the best possible guarantees of completeness and reliability.

A special Committee of the Commission grants EuroStat a budget for the implementation of the statistical programme. In 2003, EuroStat had a budget of around 56 million Euros.

EuroStat Data

Statistical data that are collected, harmonised and referenced by EuroStat are disseminated as

electronic products and computerised media, printed publications or databases. They are regularly updated and are divided into 10 major statistical themes:

- Key indicators on EU policy
- General and regional statistics
- Economy and finance
- Population and social conditions
- Industry, trade and services
- Agriculture, forestry and fisheries
- External trade
- Transport
- Environment and energy
- Science and technology

EuroStat databases

EuroStat offers a thematic selection of databases that are constantly added to, updated and harmonised. They include:

- Ramon, which houses all the past and present metadata such as classifications, concepts and definitions
- New Cronos, which contains some 70 million items of statistical data on Member States of the European Union, and, in many cases, on their main non-European economic partners
- Comext, "external trade database": for data on imports and exports by EU countries in both value and volume terms
- REGIO, containing all Member States' socio-economic data, with regional breakdown
- Eurofarm, statistical data based on the Union surveys on the structure of agricultural holdings
- GISCO, database that combines statistical information and geo-referenced data, allowing each item of data to be related to its environment
- In line with its mission as a provider of statistical information, EuroStat offers users a DataShop service. The EuroStat Data Shops network is open to the public for any information on EuroStat databases, their respective data or access possibilities, as well as any specific statistical search.

EuroStat Publications

A lot of publications published by EuroStat contain Labour Force Survey data, *Employment in Europe* being the main one (170 pages of data analyses almost exclusively using LFS data).

Others include:-

- *Employment Outlook*
- *Europe in Figures*
- *Social Portrait of Europe*
- *EuroStat Yearbook*
- *Labour Force Survey in the EU, Candidate and EFTA countries*
- *Statistics in Focus*

Ordering these and other EuroStat publications can be done via EuroStat's information and distribution network:

- *The EuroStat Data Shops Network* – aimed at the broader public, these shops answer any specific request for information, publication or statistical research.
- *Private Hosts* – they disseminate entire EuroStat databases or part of them.
- *The National Statistics Institutes* – these provide references for national publications and main EuroStat data
- *Sales Offices* – there are about 45 of these that stock all EU publications.
- *Offices and Delegations* – these are the commission's official information centres. They provide the public with statistical information on current EU developments.
- *European Documentation Centres* – there are over 750 of these centres and libraries which officially house most EuroStat publications.
- *Euro-info-centres* – these were created by the European Commission for helping small and medium sized enterprises, there are over 200 of them.

Organisation of EuroStat

EuroStat is headed by a Director-General. Under him are seven Directors responsible for different sectors of EuroStat activities:

- Resources
- Statistical methods and tools; dissemination
- National and European accounts
- Economic and regional statistics
- Agriculture and environment statistics; statistical cooperation
- Social statistics and information society
- Business statistics

A Brief History of EuroStat

Since it was founded in 1953, EuroStat has pursued its primary role of developing and setting up a reliable, complete and harmonised source of European statistical information. The following are important milestones:

| | |
|------|--|
| 1953 | Foundation of the Statistics Division of the High Authority of the Coal and Steel Community. |
| 1958 | Foundation of the Statistics Division of the European Communities. |
| 1959 | Adoption of the present title "Statistical Office of the European Communities". Staff: 58. First labour costs survey. First publication of "Agricultural statistics". |
| 1960 | First Community labour force survey. |
| 1961 | First agricultural supply balance sheet compiled on a Community basis. |
| 1962 | First overall energy balance sheets. |
| 1965 | Publication of the first national input-output tables (1959). |
| 1966 | First Community farm structure survey. |
| 1968 | First regular labour force survey in the Community. |
| 1970 | Publication of the European System of Integrated Economic Accounts (ESA). General industrial classification of economic activities within the European Communities (NACE). |
| 1972 | Council Regulation on the Nimexe nomenclature. |
| 1974 | First domain installed in the Cronos databank. |
| 1976 | First use of purchasing power parities in connection with the ESA. First forecast of agricultural incomes using the Sectoral Income Index. |
| 1978 | The Member States compile and supply statistics according to the Nimexe. |
| 1981 | Cronos accessible on-line on the Euronet network via commercial hosts. First publication of raw materials balance sheets. Publication of the "Handbook of Economic Accounts for Agriculture". |
| 1982 | On-line access to the Comext external trade databank on the Euronet network. |
| 1987 | First publication of the foreign trade volume indices. |
| 1988 | Introduction of the Harmonised System (HS) for the Collection and processing of external trade data according to the combined nomenclature (CN). Communication to the Commission on Community policy and statistical information. |
| 1989 | Adoption of the Directive on the compilation of GNP. Adoption by the Council of the 1989-1992 Statistical Programme as an instrument for |

Labour Force Survey - United Kingdom

- implementing statistical information policy.
- 1990 As a result of German unification on 3 October 1990, the sphere of responsibility of the EC and hence of EuroStat increases.
- 1991 EuroStat's role extended as a result of the agreement on the establishment of the EEA (European Economic Area) in October 1991.
In December, adoption of the Treaty on European Union by the European Council in Maastricht ushers in a new phase for EuroStat.
All statistical data on EC external trade and trade between Member States (Comext) published on CD-ROM.
- 1992 Adoption of the 1993-1997 Statistical Programme, which includes the EFTA countries.
- 1993 Start of the single market in 1993 extends EuroStat's activities (e.g. Intrastat).
Publication of the new CD-ROM: general socio-economic information.
EuroStat starts issuing regular news releases on its statistics and achieves widespread publicity in the European news media.
- 1994 First European household panel held, analysing income, employment, poverty, social exclusion, households, health etc
- 1995 The entry of Austria, Sweden and Finland into the European Union further extends EuroStat's role.
- 1997 Statistics added for the first time to the Treaty of Amsterdam and the Statistical Law approved by the Council. Harmonised Indices of Consumer Prices published for the first time - designed for EMU convergence criteria.
- 1998 The 11 countries in at the start of EMU (EUR-11) announced and EuroStat issues the first indicators specific to the EMU area. Statistical programme 1998-2002 adopted.
- 1999 Start of EMU, 1st January 2001 Greece joins to euro-zone,
- 2002 Start of the euro, 1st January. Statistical programme 2003-2007 adopted.
- 2002 Announced at the Copenhagen Summit in December 2002 that Cyprus, the Czech Republic, Estonia, Hungary, Latvia, Lithuania, Malta, Poland, Slovakia and Slovenia would join the European Union on 1 May 2004, and other countries should follow in 2007.
- 2004 Start of free of charge dissemination of all statistical data except microdata for research purposes.
- 2005 Commission Recommendation on the independence, integrity and accountability of the national and Community statistical authorities (European Statistics Code of Practice)
- 2005 Start of a three year peer review exercise across the European Statistical System to check the compliance with the Code of Practice.
- 2007 The currently valid 5 years Statistical Programme.
- 2008-2012 was adopted 2009 New European Regulation governing the statistical cooperation in the European Union was adopted.

EuroStat Address

Statistical Office of the European Communities
Batiment Joseph Bech
5 Rue Alphonse Weicker
L-2721 Luxembourg

Telephone (+352) 4301-34567 Fax (+352) 4301-32594
E-mail info.desk@EuroStat.cec.eu.int
Web site <http://europa.eu.int/EuroStat.html>

SECTION 3: LABOUR FORCE SURVEYS IN THE EUROPEAN UNION

The purpose of labour force surveys

A labour force survey is a survey directed to households designed to obtain information on the labour market and related issues by means of personal interviews. As it would clearly involve considerable expense to include all households (as in population censuses) labour force surveys are usually confined to a sample of households, the actual size of which depends primarily on the level of detail required in the survey estimates.

There are a number of advantages in using an approach of this kind in collecting labour market information. In the first place it affords the opportunity to obtain information on relevant labour market aspects across all sectors of the economy in a consistent manner. It also facilitates the interpretation of the information in a wider population setting, since the information collected need not necessarily be confined to persons in the labour force (i.e. those employed or unemployed), but can involve all other persons in the households covered. In current labour market circumstances this is an important additional dimension as analysis is increasingly concerned with those on the peripheries of the labour market.

In recent decades the borderline between the labour force and what is termed the *economically inactive* population has become increasingly blurred, due to the increasing incidence of part-time and temporary work and the ease with which large numbers of persons (particularly women and young persons in the final stages of their education) repeatedly enter or leave the labour force. Furthermore, the emergence of mass unemployment and long-term unemployment resulted in a great many individuals becoming “marginalised” in the sense that they tend to lose tangible contact with the core labour market. The wider coverage associated with labour force surveys also allow the possibility of assessing labour market effects in a household or family context. This is important if, for example, one wants to measure the extent to which persons other than those directly involved (e.g. spouses, other dependants, etc.) are affected by the circumstances of unemployment.

Another advantage of a labour force survey is that it affords the opportunity to define certain labour market characteristics not normally available from other statistical sources. Thus, for example, it is possible to identify the degree of employment engaged in by an individual in terms of the hours worked, or attempt to conceptualise unemployment in terms of aspects such as job search and availability for work. This is important because of the advantages it confers in being able to define certain labour market entities in a more meaningful way. Additionally, because the definitions used to measure these entities are the same for each country, comparability between Member States is guaranteed for certain estimates. This aspect is clearly of considerable importance in the context of the European Union.

There are however some limitations which apply to labour force surveys. Cost considerations place a constraint on the overall household sample size and the resultant sampling variability limits the level of detail that can reasonably be shown. Thus, for example, while the labour force survey can be used to compile estimates of employment across economic sectors, it cannot be expected to yield reliable figures at a detailed level of regional desegregation, nor for individual small industrial or commercial sub-sectors. The sampling base on which such estimates would depend would be too small, and the degree of variability correspondingly high. For the same reason, there is also a limit to what can be

achieved with labour force surveys in monitoring trends over time (in employment and unemployment, for example), especially if the movements involved are relatively small.

It is appropriate at this point to refer briefly to other sources of statistical information so that the position of the labour force survey in an overall statistical perspective can be more clearly understood. The other principal sources of labour market information are:-

- (a) surveys of enterprises and
- (b) administrative records.

The former source clearly has the potential for providing detailed estimates of employment for individual sectors (and in fact this is done in many countries). However, such a source is clearly restricted to a consideration of those with jobs and cannot provide any information on the unemployed, nor other persons outside the labour force but who may have an attachment to it. Such surveys can, however, be used to obtain information, not only in relation to employment, but also to output, earnings and hours worked. The simultaneous collection of consistent data on employment and output makes it possible to compile indicators of productivity. Indeed, the derivation of output-type information is usually the main purpose of enterprise-based surveys. Many countries, for example, carry out detailed quarterly or monthly surveys of the industrial sector which provide consistent information on output, earnings, employment and other related aspects.

Administrative records, such as social insurance records or population registers as widely used in Denmark, Sweden and Finland, can also be used to provide indicators of the levels of employment and unemployment. A prerequisite, however, is that the administrative arrangements should specifically cater for the extraction of the relevant statistics. While this source involves relatively less expense than information derived from either enterprise or household surveys, it suffers from a significant disadvantage in that the underlying systems are based on social welfare or other administrative provisions which may not necessarily accord with the accepted conventions for defining employment and unemployment. Furthermore, if these arrangements are changed (and experience indicates that they frequently are), discontinuity invariably arises in the data. A disadvantage of even greater relevance in an international or EU context is the fact that the social insurance systems in question vary greatly from country to country, both in terms of their design and in the manner of their implementation. This renders the derived information virtually useless in the context of making comparisons between countries, especially in absolute terms. Such sources can, however, provide a reasonable basis for monitoring short-term (i.e. monthly, quarterly, etc.) trends, the most notable in this regard being the various national series on the registered unemployed.

To summarise, therefore, the principal advantages associated with labour force surveys relate to:

- (1) the opportunity of obtaining comprehensive information (at less cost than a census) across the entire economy, which can be assessed in a global setting embracing society as a whole;
- (2) the inherent flexibility of such surveys, which makes it possible to define or conceptualise not only employment and unemployment, but also the circumstances surrounding other groups outside or on the margins of the labour force.

This latter feature (i.e. the facility to conceptualise or define) has assumed greater importance in recent years because of the manner in which labour markets and society have generally evolved, and in view of the growing need to view labour market phenomena in an international context. It must be recognised, however, that the sampling aspect associated with labour force surveys places a limitation on the level of detail possible when analysing the results.

The history of labour force surveys

The notion of obtaining information on the work force by means of household-based surveys is not in any sense new. Questions on the concept of possessing a *gainful occupation* were introduced in censuses of population in some countries during the latter half of the last century. However, at that stage no questions were asked in regard to what is termed a person's economic status, i.e. whether at work, unemployed or economically inactive. Indeed, at that stage such a notion was hardly even conceived. However, the advancing trend of industrialisation and the resultant restructuring of society created a need for new, approaches, and for more sophistication in measuring labour market phenomena. The situation became particularly urgent with the advent of mass unemployment in the 1930's following the Great Depression. Whatever the uncertainties that may have previously existed regarding the need to conceptualise or measure unemployment were dispelled by the sheer fact of millions in a state of enforced idleness. There was now a clear need to have regular information on the level and trend of employment and unemployment. The first labour force survey was introduced in the United States in 1940 (on a monthly basis) with a new conceptual framework designed to provide information on relevant labour market characteristics.

The movement towards the use of labour force surveys was somewhat slower in Europe. While the intervention of the war years contributed to this, it was also due to the existence of alternative sources of information which provided at least a partial insight into aspects of the labour force. Virtually all Western European countries maintained comprehensive unemployment registers for the purpose of dispensing unemployment compensation which, despite their disadvantages, provided a rudimentary basis for monitoring unemployment trends. However, in time, as the need to take a more global view of the labour market became apparent, different European countries began to initiate labour force surveys. The first European country to carry out a labour force survey was France in 1950. Further such surveys were conducted in France throughout the subsequent decade and these evolved into a regular consistent series in the early 1960s. After an extended period of preparation, the Federal Republic of Germany initiated an annual series of labour force surveys in 1957 (the Mikrozensus). Sweden conducted its first labour force survey in 1959 and, after further experimentation, initiated a quarterly series in 1963.

The development of the EU Labour Force Survey

More than forty years have passed since the first attempt was made in 1960 to collect comparable data on employment and unemployment from the six original Member States of the then European Community by means of a labour force survey. Since that date, the number of Member States has risen to twenty-five and the character of the European labour market has been transformed by the changes which have taken place, for example in employment rates, in the allocation of working-time, and in the distribution of employment across the various sectors of the economy.

Throughout this period, the institutions of the European Union have included the issues of employment and unemployment among their highest priorities. In consequence, the demand

for accurate and comparable information on the labour market has progressively become more urgent.

In this context, the role of the EU Labour Force Survey (LFS) has gained steadily in importance and is now universally recognised as an indispensable tool for observing labour market developments and for taking the appropriate policy measures. The LFS is the only source of information in these areas to provide data, which is truly comparable in the sense of being independent of the national administrative and legislative framework. Among the statistical instruments available in the European Union, the LFS is unique for the sample-size it covers, for the length of the time-series which it offers, and for the unrivalled picture it can provide of economic and social developments from the very earliest days of the European Community right up to the present day.

| No. | From | To | Main developments |
|-----|------|------|---|
| 1. | 1960 | | The first LFS was organised in the six original member states in 1960 by EuroStat. The countries are Belgium, Germany, France, Italy, Luxembourg and Netherlands. |
| 2. | 1968 | 1971 | Annual surveys introduced. Not all six member states were covered in each year. |
| 3. | 1973 | 1981 | Biennial surveys initiated due to EU enlargement. The UK was the only one of the three new members to join in 1973 but Ireland and Denmark also took part in 1975, 1977, 1979 and 1981. |
| 4. | 1983 | 1991 | Annual surveys on the basis of a revised set of concepts designed to guarantee an improved degree of comparability between the member states. The concepts and definitions used were those adopted by the 13th International Conference of Labour Statisticians of 1982. The methodological basis is described in the publication <i>LFS - Methods and Definitions 1988</i> . |
| 5. | 1992 | 1997 | In 1992, a number of changes were introduced with the aim of improving the quality of the data and their reliability at national and regional level; Council Regulation (EEC) 3711/1991 specified the contents and reliability criteria for the survey, to be conducted annually from 1992. The methodological basis and the content of the series of surveys between 1992 and 1997 are described in the publication <i>LFS - Methods and Definitions - 1992 series</i> . |
| 6. | 1995 | 2000 | LFS covers all 15 member states. |
| 7. | 1998 | 2000 | In 1998 the Council regulation n° 577/1998 was adopted and replaced the previous one to take into account new statistical requirements. The methodological basis and the contents of this new series of surveys are described in the publication <i>LFS - Methods and Definitions -1998</i> . |
| 8. | 2001 | 2005 | In 2000 the regulation n° 1575/2000 was adopted concerning the codification to be used for data transmission from the year 2001 onwards. The 2001 codification can be found at http://forum.europa.eu.int/irc/dsis/employment/info/data/eu_lfs/lfs_regulations.htm |
| 9. | 2000 | | LFS covers all 25 member states. |
| 10. | 2002 | | Regulation 1991/2002 of the European Parliament and of the Council of 8 October 2002 amending Council Regulation (EC) No 577/98 on the organisation of a labour force sample survey in the Community introduced a deadline (end of 2002) for the period of transition given to the Member States to introduce a continuous quarterly survey (derogation periods for Cyprus until the end of 2004 and Germany until the end of 2005). |
| 11. | 2005 | | Regulation No. 430/2005 amended 577/98 on the organisation of a labour force sample survey in the Community concerning the codification to be used for data transmission from 2006 onwards and the use of a sub sample for the collection of data on structural variables. |
| 12. | 2008 | | Regulation No. 377/2008 amended 577/98 on the organisation of a labour force sample survey in the Community concerning the codification to be used for data transmission from 2009 onwards and the use of a sub sample for the collection of data on structural variables. |

The Organisation of the EU Labour Force Survey

The earliest Community Labour Force Surveys were not covered by legislation, but, from 1973 onwards, a Regulation was passed by the Council of Ministers governing the operation of the survey. Each Regulation applied only to a single year's survey, until the surveys of 1990 and 1991 were included in one Regulation (Council Regulation (EEC) No. 3044/89). In 1998 a new Regulation was adopted (Council Regulation (EEC) No. 577/98).

EU regulations stipulate the agreements reached by the Member States and EuroStat on the implementation of the survey. The technical aspects of the survey are discussed by EuroStat and representatives of the respective national statistical offices and employment ministries, meeting regularly (between one and three times a year) at the Labour Market Statistics Working Group held in Luxembourg. This Working Group determines the content of the survey, the EU list of questions and the common coding of individual replies, as well as the principal definitions to be applied for the analyses of the results.

The national statistical institutes are responsible for selecting the sample, preparing the questionnaires, conducting the direct interviews among households, and forwarding the results to EuroStat in accordance with the common coding scheme. EuroStat devises the programme for analysing the results and is responsible for processing and disseminating the information sent by the national statistical institutes.

The questionnaires are drawn up by each Member State in the national language or languages, taking into account the stipulations made in the Regulation. For every survey characteristic listed in the Regulation, a question or series of questions exists in each questionnaire to permit this information to be supplied to EuroStat. Otherwise the information is imputed from other sources such as population registers. The questionnaires may also contain other questions which do not relate to the list of characteristics in the Regulation, but rather reflect an interest in the topic concerned at national level. Based on the sample design the figures obtained from the sample survey are expanded to population levels, usually on the basis of weighting factors derived from the most recent census of population, suitably adjusted to take account of recent changes which may have occurred since that census.

Data Collection and diffusion of results

As soon as each Member State has completed its data collection and verification, the part pertaining to the EU Labour Force Survey is, if necessary, transcoded to EuroStat requirements and transmitted by magnetic support. EuroStat then checks the data for errors according to its own programme of controls. When the data are considered to be error-free they are converted into a SAS database, which can be easily accessed to produce reports. For reasons of confidentiality this database may only be accessed by accredited EuroStat personnel.

Most Member States produce regular publications setting out the results of their national surveys. The yearly report at EU level, which, as mentioned, is the responsibility of EuroStat, contains five main sections covering population and activity, employment, working time, unemployment and search for work, and households. Some specific organisational and methodological notes are included in this publication, but, in the interests of rapid diffusion of the results, an attempt is made to analyse the data. From 1994 onwards a selection of graphs has been included in order to improve the presentation of the results.

Detailed studies of labour market developments in the European Union may be found in the annual Commission Report Employment in Europe and, in the wider context of the highly-developed countries, in the OECD's Employment Outlook. Data are supplied from the EU LFS database for these publications as well as for a plethora of other studies and reports at national and international level.

Within EuroStat, the richness of the EU Labour Force Survey, including its household dimension, causes it to be frequently used for general publications such as *Europe in Figures* and the *Social Portrait of Europe*. The EU LFS database is also occasionally used to provide data for the publication of Rapid Reports by other services of EuroStat. Among more specialised applications is the use of the database to produce comparable annual estimates of unemployment which, when combined with monthly national administrative data, provide comparable unemployment rates, as published in EuroStat's monthly *bulletin Unemployment in the European Union*. Additionally, the preparation of policy actions in the field of EU social and regional policy through the operation of the Structural Funds relies upon the availability of a solid base of comparable data from the EU Labour Force Survey.

The survey results are completely integrated into the EuroStat statistical system, so that they may be consulted for example through the New Cronos and Regio databases. Users with specific data requirements which are not satisfied by the existing publications and databases may also ask for specified tables to be produced on a chargeable basis. Several hundred such requests are received each year from different public and private bodies, research institutes, universities, etc. They may be addressed to the central EuroStat Information Office (+352-4301-34567; fax 4301-436404), and EuroStat is currently extending its data dissemination facilities, setting up Data Shops in every Member State.

The growing volume of this demand for information is an eloquent testimony to the central role of the Labour Force Survey in the European Statistical System. In the field of social statistics there is no other instrument which provides information on social and economic developments within the European Union over such a long time-span, with such a large sample-size or with such a level of comparability.

SECTION 4: TECHNICAL FEATURES OF THE EU LABOUR FORCE SURVEY

Field of the Survey

The survey is intended to cover the whole of the resident population, i.e. all persons whose usual place of residence is in the territory of the Member States of the European Union. For technical and methodological reasons, however, it is not possible in all countries to include the population living in collective households, i.e. persons living in homes, boarding schools, hospitals, religious institutions, workers' hostels, etc.

Consequently, for the purpose of harmonising the field of survey, results are compiled for the population of private households only. This comprises all persons living in the households surveyed during the reference week, and those persons absent from the household for short periods due to studies, holidays, illness, business trips, etc.

It does not cover persons who, although having links with the household under survey:

- (a) usually live in another household;
- (b) live in collective households (in particular, persons doing compulsory military service are excluded from the population of private households and regarded as members of collective households, even if during the reference week they are present in the private household to which they belong);
- (c) have emigrated.

Reference period

The labour force characteristics of each person interviewed refer to their situation in a particular week. While this reference week falls in spring in all countries, the national statistical institutes determine the exact week(s) according to the particular situation in each country. The reference weeks used in the different Member States are shown in the yearly reports containing the survey results. As a general rule the reference week should be a normal week, i.e. it should exclude bank holidays. For countries using a fixed reference week, this requirement is easy to fulfil. In some countries, however, the survey extends over a period of time and, as the reference week is the one preceding the week of the interview, the reference week varies. In this case, the reference week may sometimes include public holidays, such as Easter.

Units of measurement

The main units of measurement for which results are obtained from the survey are individuals and households. The definition of a household varies somewhat from country to country but these differences are unlikely in the majority of cases to have a significant effect on the comparability of the results.

Reliability of the results

As with any sample survey, the results of the Labour Force Survey are subject to sampling errors. In addition, the results of any sample survey are affected by non-sampling errors, i.e. the whole variety of errors other than those due to sampling. These can be due to many factors such as inability or unwillingness of respondents to provide correct answers or even any answer at all (non-response), mistakes by interviewers when filling in survey documents, miscoding, etc. Methods exist to assess the influence of these non-sampling errors on the accuracy of the survey results, but being often costly, are not generally applied.

Experience shows that at national level the survey information provides sufficiently accurate estimates for the levels and structures of the various aggregates into which the labour force is divided, provided that analyses of this type are confined to levels of a certain size. Survey results at regional level may, however, be affected by considerable sampling errors, even for relatively large groups of the population. Reliability of the results is assured by the size of the samples and the sampling methods used, in addition to careful and thorough planning of the various survey operations and rigorous administration of all phases of the survey.

Comparability of results between countries

Perfect comparability among the countries is difficult to achieve, even were it to be by means of a single direct survey, i.e. a survey carried out at the same time, using the same questionnaire and a single method of recording.

Nevertheless, the degree of comparability of the EU Labour Force Survey results is considerably higher than that of any other existing set of statistics on employment or unemployment available for Member States. This is due to:

- (i) the recording of the same set of characteristics in each country;
- (ii) a close correspondence between the EU list of questions and the national questionnaires;
- (iii) the use of the same definitions for all countries;
- (iv) the use of common classifications (e.g. NACE for economic activity);
- (v) the synchronisation of the survey in spring;
- (vi) the data being centrally processed by EuroStat.

The EU Labour Force Survey, although subject to the constraints of the EU's statistical requirements, is a joint effort by Member States to co-ordinate their national employment surveys, which must serve their own national requirements. Therefore, in spite of the close co-ordination between the national statistical institutes and EuroStat, there inevitably remain some differences in the survey from country to country. This is especially the case for population coverage, labour status coverage, main economic activity definition, participation in education, highest educational level attainment and transition to a quarterly continuous survey. The new LFS Explanatory Notes developed for implementation from quarter 1, 2008, have been designed to ensure greater harmonisation and comparability of results between countries.

Comparability of results between successive surveys

Since 1983 improved comparability between results of successive surveys has been achieved, mainly due to the greater stability of content and the higher frequency of surveys. However, the following factors may somewhat detract from perfect comparability:

- (i) the population figures used for the population adjustment are revised at intervals on the basis of new population censuses;
- (ii) the reference period may not remain the same for a given country;
- (iii) in order to improve the quality of results, some countries may change the content or order of their questionnaire;
- (iv) countries may modify their sample designs;
- (v) the manner in which certain questions are answered may be influenced by the political or social circumstances at the time of interview.

EuroStat has provided the main factors affecting the comparability of the data for successive surveys in their publications containing the results.

Basic concepts and definitions

The main statistical objectives of the Labour Force Survey is to divide the population of working age (15 years and above) into three mutually exclusive and exhaustive groups - persons in employment, unemployed persons and inactive persons - and to provide descriptive and explanatory data on each of these categories. Respondents are assigned to one of these groups on the basis of the most objective information possible obtained through the survey questionnaire, which principally relates to their actual activity within a particular reference week.

The definitions of employment and unemployment used in the Labour Force Survey closely follow those adopted by the 13th International Conference of Labour Statisticians.

The relevant parts of these 'ILO definitions' are:

Employment

9.(1) The employed comprise all persons above a specified age who during a specified brief period, either one week or one day, were in the following categories:

- (a) "paid employment":
 - (al) "at work": persons who during the reference period performed some work for wage or salary, in cash or in kind;
 - (a2) "with a job but not at work": persons who, having already worked in their present job, were temporarily not at work during the reference period and had a formal attachment to their job. This formal job attachment should be determined in the light of national circumstances, according to one or more of the following criteria:
 - (i) the continued receipt of wage or salary;
 - (ii) an assurance of return to work following the end of the contingency, or an agreement as to the date of return;
 - (iii) the elapsed duration of absence from the job which, wherever relevant, may be that duration for which workers can receive compensation benefits
 - (bl) "at work": persons who during the reference period performed some work for profit or family gain, in cash or in kind;
 - (b2) "with an enterprise but not at work": persons with an enterprise, which may be a business enterprise, a farm or a service undertaking, who were temporarily not at work during the reference period for any specific reason.

9.(2) For operational purposes, the notion of "some work" may be interpreted as work for at least one hour.

Unemployment

10.(1) The "unemployed" comprise all persons above a specified age who, during the reference period, were:

- (a) "without work", i.e. were not in paid employment or self-employment, as defined in paragraph 9;
- (b) "currently available for work", i.e. were available for paid employment or self-employment during the reference period-;
- (c) "seeking work", i.e. had taken specific steps in a specified recent period to seek paid employment or self-employment.

In applying these definitions to the EU Labour Force survey, the following reference periods are implemented:

- (i) In paragraph 10(b) "currently available" should mean available to start work within two weeks of the reference period.
- (ii) In paragraph 10(c) the "specified recent period" is the four weeks preceding the survey interview. During this period at least one active method to find work should be undertaken in order to satisfy the criterion of "seeking work".

Unemployed persons can be classified by reason for unemployment into four major groups-.

- (1) job-losers are persons whose employment ended involuntarily and immediately began looking for work;
- (2) job-leavers are persons who quit or otherwise terminated their employment voluntarily and immediately began looking for work-;
- (3) re-entrants are persons who previously worked, but were inactive or on compulsory military service before beginning to look for work;
- (4) first job-seekers are persons who have never worked in a regular job.

Labour force

The labour force comprises persons in employment and unemployed persons.

Inactive persons

All persons who are not classified as employed or unemployed are defined as inactive. Apart from showing pupils and students separately, no further breakdown is provided for this group. Conscripts on compulsory military or community service are excluded from the compilation of the survey results.

The above groups are used to derive the following measures:

- (a) *Activity rates*
Activity rates represent the labour force as a percentage of the population of working age (15 years or more).

- (b) *Employment/ population ratios*

Employment / population ratios represent persons in employment as a percentage of the population of working age (15 years or more).

(c) *Unemployment rates*

Unemployment rates represent unemployed persons as a percentage of the labour force.

(d) *Duration of unemployment*

defined as the shorter of the following two periods (a)the duration of search for work, or (b)the length of time since last employment.

The above rates are usually calculated for sex-age groups and are sometimes further cross-classified by other demographic variables such as marital status or nationality.

SECTION 5a:

COUNCIL REGULATION 577/98 OF THE EUROPEAN UNION

Whereas, in order to carry out the tasks assigned to it, the Commission needs comparable statistical information on the level and pattern of and trends in employment and unemployment in the Member States;

Whereas the best method of obtaining such information at Community level is to conduct harmonised labour force surveys;

Whereas Council Regulation (EEC) No 3711/91 of 16 December 1991 on the organisation of an annual labour force sample survey in the Community laid down that, starting in 1992, a survey was to be conducted in the spring of each year;

Whereas, although a continuous survey is preferable to an annual spring survey for ensuring the availability and harmonisation of data and measuring the volume of work, it is difficult to implement a continuous survey on the same dates in all Member States.

Whereas the use of existing administrative sources should be encouraged insofar as they can usefully supplement the information obtained through interviews or serve as a sampling basis;

Whereas the date in the survey, as fixed by this Regulation, may be extended to include a further set of variables forming part of a programme of ad hoc modules which covers several years, and which will be drawn up under an appropriate procedure as part of the implementation arrangements;

Whereas the principles of relevance and cost-effectiveness, as these are defined in Council Regulation (EC) No 322/97 of 17 February 1997 on Community Statistics which constitutes the legislative framework for the production of Community statistics, will also apply to this Regulation;

Whereas statistical confidentiality is governed by the rules set out in Regulation (EC) No 322/97 and in Council Regulation (Euratom, EEC) No 1588/90 of 11 June 1990 on the transmission of data subject to statistical confidentiality to the Statistical Office of the European Communities;

Whereas the Statistical Programme Committee established by Decision 89/382/EEC, Euratom has been consulted by the Commission in accordance with Article 3 of the aforesaid Decision,
has adopted this regulation:

Article I **Frequency of the survey**

A labour force sample survey, hereinafter referred to as 'the survey', shall be conducted by the Member States each year.

The survey is a continuous survey providing quarterly and annual results; however, those Member States which are not in a position to implement a continuous survey may carry out an annual survey only, to take place in the spring.

The information collected during the survey relates generally to the situation during the course of the week (taken to run from Monday to Sunday) preceding the interview, known as the reference week.

In the case of a continuous survey:

the reference weeks are spread uniformly throughout the whole year;

- the interview normally takes place during the week immediately following the reference week. The reference week and the date of the interview may not be more than five weeks apart, except in the third quarter;
- the reference quarters and years are respectively groups of 13 or 52 consecutive weeks. A list of the weeks making up a given quarter or year is drawn up according to the procedure laid down in Article 8.

Article 2

Units and scope of the survey, observation methods

1. The survey shall be carried out in each Member State in a sample of households or of persons residing in the economic territory of that State at the time of the survey.
2. The principal scope of the survey consists of persons residing in private households on the economic territory of each Member State. If possible, this main population of persons living in private households is supplemented by persons living in Collective households.

Wherever possible, Collective households are covered by means of samples specially drawn to permit direct observation of the persons concerned. If this is not possible, then persons in these groups who continue to have an association with a private household are included in connection with that household.

3. The variables used to determine labour status and underemployment must be obtained by interviewing the person concerned, or, if this is not possible, another member of the household. Other information may be obtained from alternative sources, including administrative records, provided that the data obtained are of equivalent quality.
4. Regardless of whether the sampling unit is an individual or a household, information is usually collected for all individuals of the household. However, If the sampling unit is an individual, the information concerning the other members of the household
 - may exclude the characteristics listed under Article 4(1)(g), (h), (i) and (j),
 - and may be Collected from a sub-sample defined in such a way that:
 - the reference weeks are uniformly distributed throughout the whole year;
 - the number of observations (individuals sampled plus the members of their household) satisfies, for the annual estimates of levels, the reliability criteria defined in Article 3.

Article 3 **Representativeness of the sample**

1. For a group of unemployed people representing 5% of the working age population the relative standard error for the estimation of annual averages (or for the spring estimates in the case of an annual survey in the spring) at NUTS II level shall not exceed 8% of the sub-population in question. Regions with less than 300,000 inhabitants shall be exempt from this requirement.
2. In the case of a continuous survey, for sub-populations which constitute 5% of the working age population the relative standard error at national level for the estimate of changes between two successive quarters, shall not exceed 2 % of the sub-population in question.

For Member States with a population of between one million and twenty million inhabitants, this requirement is relaxed so that the relative standard error for the estimate of quarterly changes shall not exceed 3% of the sub-population in question.

Member States whose population is below one million inhabitants are exempt from these precision requirements concerning changes.

3. Where the survey is carried out only in the spring, at least a quarter of the survey units are taken from the preceding survey and at least a quarter form part of the following survey.

These two groups shall be identified by a code.

4. Where non-response to certain questions results in missing data, a method of statistical imputation shall be applied where appropriate.
5. The weighting factors we calculated taking into account in particular the probability of selection and external data relating to the distribution of the population being surveyed by sex, age (five-year age groups), and region (NUTS II level), where such external data are held to be sufficiently reliable by the Member States concerned.
6. Member States shall provide the Commission (EuroStat) with whatever information is required concerning the organisation and methodology of the survey, and in particular, they shall indicate the criteria adopted for the design and size of the sample.

Article 4 **Survey characteristics**

1. Data shall be provided on;
 - (a) demographic background:
 - sequence number in the household
 - sex
 - year of birth
 - date of birth in relation to the end of the reference period
 - marital status
 - relationship to reference person

- sequence number of spouse
 - sequence number of father
 - sequence number of mother
 - nationality
 - number of years of residence in the Member State
 - country of birth (optional)
 - nature of participation in the survey (direct participation or proxy through another member of the household);
- (b) labour status;
- labour status during the reference week
 - reason for not having worked though having a job
 - search for employment for person without employment
 - type of employment sought (self-employed or employee)
 - methods used to find a job
 - availability to start work;
- (c) employment characteristics of the main job:
- professional status
 - economic activity of local unit
 - occupation
 - number of persons working at the local unit
 - country of place of work
 - region of place of work
 - year and month when the person started working in current employment
 - permanency of the job (and reasons)
 - duration of temporary job or work contract of limited duration
 - full-time/part-time distinction (and reasons)
 - working at home;
- (d) hours worked:
- number of hours per week usually worked
 - number of hours actually worked
 - main reason for hours actually worked being different from person's usual hours;
- (e) second job:
- existence of more than one job
 - professional status
 - economic activity of the local unit
 - number of hours actually worked
- (f) visible underemployment:
- wish to work usually more than the current number of hours (optional in the case of an annual survey)
 - looking for another job and reasons for doing so
 - type of employment sought (as employee or otherwise)
 - methods used to find another job

- reasons why the person is not seeking another job (optional in the case of an annual survey)
- availability to start work
- number of hours of work wished for (optional in the case of an annual survey);
- (g) search for employment:
 - type of employment sought (full-time or part-time)
 - duration of search for employment
 - situation of person immediately before starting to seek employment
 - registration at public employment office and whether receiving benefits
 - willingness to work for person not seeking employment
 - reasons why person has not sought work;
- (h) education and training
 - participation in education or training during previous four weeks
 - purpose
 - level
 - type
 - total length
 - total number of hours
 - highest successfully completed level of education or training
 - year when this highest level was successfully completed
 - non-tertiary vocational qualification obtained;
- (i) previous work experience of person not in employment:
 - existence of previous employment experience
 - year and month in which the person last worked
 - main reason for leaving last job or business
 - professional status in last job
 - economic activity of local unit in which person last worked
 - occupation of last job;
- (j) situation one year before the survey (optional for quarters 1, 3, 4):
 - main labour status
 - professional status
 - economic activity of local unit in which person was working
 - country of residence;
 - region of residence;
- (k) main labour status (optional);
- (l) income (optional);
- (m) technical items relating to the interview
 - year of survey
 - reference week
 - interview week
 - member State

- region of household
 - degree of urbanisation
 - serial number of household
 - type of household
 - type of institution
 - weighting factor
 - sub-sample in relation to the preceding survey (annual survey)
 - sub-sample in relation to the following survey (annual survey)
 - sequence number of the survey wave.
2. A further set of variables, hereinafter referred to as an “ad hoc module”, may be added to supplement the information described above in paragraph 1.
- A programme of ad hoc modules covering several years shall be drawn up each year according to the procedure laid down in Article 8:
- this programme shall specify for each ad hoc module, the subject, the reference period, the sample size (equal to or less than the sample size determined according to Article 3) and the deadline for the transmission of the results (which may be different from the deadline according to Article 6);
 - the Member States and regions covered and the detailed list of information to be collected in an ad hoc module shall be drawn up at least twelve months before the beginning of the reference period for that module;
 - the volume of an ad hoc module shall not exceed the volume of the module described under paragraph 1
3. The definitions, the edits to be used, the codification of the variables, the adjustment of the list of survey variables made necessary by the evolution of techniques and concepts, and a list of principles for the formulation of the questions concerning the labour status, are drawn up according to the procedure laid down in Article 8.

Article 5 **Conduct of the survey**

The Member States may make it compulsory to reply to the survey.

Article 6 **Transmission of the results**

Within twelve weeks of the end of the reference period in the case of a continuous survey (and within nine months of the end of the reference period in the case of a survey in the spring), the Member States shall forward to EuroStat the results of the survey, without direct identifiers.

Article 7 **Reports**

A report on the implementation of this regulation shall be submitted to the commission to the Parliament and the Council every three years, beginning in the year 2000. This report shall

evaluate in particular the quality of the statistical methods envisaged by the member states to improve the results or to lighten the survey procedures.

Article 8 Procedure

The Commission shall be assisted by the Statistical Programme Committee, hereinafter referred to as "the Committee".

The representative of the Commission shall submit to the Committee a draft of the measures to be taken. The Committee shall deliver its opinion on the draft within a time limit which the chairman may lay down according to the urgency of the matter. The opinion shall be delivered by the majority laid down in Article 148(2) of the Treaty in the case of decisions which the Council is required to adopt on a proposal from the Commission. The votes of the representatives of the Member States within the Committee shall be weighted in the manner set out in that Article. The chairman shall not vote.

The Commission shall adopt the measures envisaged if they are in accordance with the opinion of the Committee.

If the measures envisaged are not in accordance with the opinion of the Committee, or if no opinion is delivered, the commission shall, submit to the council a proposal relating to the measures to be taken. The council shall act by a qualified majority.

If, on the expiry of a period of three months from the date of referral to the Council, the Council has not acted, the proposed measures shall be adopted by the Commission.

Note that Commission Regulation (EC) No 1575/2000 of 19 July 2000 implements Council Regulation (EC) No 577/98 on the organisation of a labour force sample survey in the Community concerning the codification to be used for data transmission from 2001 to 2005 (OJ No L 181/16).

The 2001 to 2005 codification can be found at
http://forum.europa.eu.int/irc/dsis/employment/info/data/eu_lfs/lfs_regulations.htm

Note that Commission Regulation (EC) No 430/2005 of 15 March 2005 implements Council Regulation (EC) No 577/98 on the organisation of a labour force sample survey in the Community concerning the codification to be used for data transmission from 2006 onwards.

Note that Commission Regulation (EC) No 377/2008 of 25 April 2008 implements Council Regulation (EC) No 577/98 on the organisation of a labour force sample survey in the Community concerning the codification to be used for data transmission from 2008 onwards.

SECTION 5b: COMMISSION REGULATION 2257/2003 OF THE EUROPEAN UNION

This is an amendment of Council Regulation (EC) No 577/98.

Whereas:

- (1) The labour force sample survey to be carried out under Council Regulation (EC) No 577/98 should adequately cover new and recently emerging features of the labour market.
- (2) According to the European social policy agenda adopted by the Nice European Council in December 2000, Council Decision 2002/177/EC of 18 February 2002 on guidelines for Member States' employment policies for the year 2002 and Council Recommendation 2002/549/EC of 21 June 2002 on the broad guidelines of the economic policies of the Member States and the Community, the way in which work is organised must be adapted to the needs of both businesses and individuals.
- (3) The survey characteristics laid down in Regulation (EC) No 577/98 were determined according to statistical needs and the labour market situation prevailing at the time.
- (4) Data collection should not impose on respondents a burden out of proportion with the results which users of the survey can reasonably expect.
- (5) The Statistical Programme Committee, established by Council Decision 89/382/EEC, Euratom of 19 June 1989 has been consulted by the Commission.
- (6) Regulation (EC) No 577/98 should therefore be amended accordingly,

HAVE ADOPTED THIS REGULATION:

Article 1

Article 4 of Regulation (EC) No 577/98 is hereby amended as follows:

1. Points (b), (c), (d) and (g) of paragraph 1 are replaced by the following:

‘(b) labour status:

- labour status during the reference week,
- continuing receipt of wages and salary,
- reason for not having worked though having a job,
- search for employment for person without employment,
- type of employment sought (self-employed or employee),
- methods used to find a job,
- availability to start work;

(c) employment characteristics of the main job:

- professional status,
- economic activity of the local unit,
- occupation,
- supervisory responsibilities,
- number of persons working at the local unit,
- country of place of work,
- region of place of work,
- year and month when the person started working in current employment,

- involvement of public employment service in finding the current job,
- permanency of the job (and reasons),
- duration of temporary job or work contract of limited duration,
- full-time/part-time distinction (and reasons),
- contract with a temporary work agency,
- working at home;

(d) hours worked:

- number of hours per week usually worked,
- number of hours actually worked,
- number of hours of overtime in the reference week,
- main reason for hours actually worked being different from usual hours;'

'(g) search for employment:

- type of employment sought,
- duration of search for employment,
- situation of person immediately before starting to seek employment,
- registration at public employment office and whether receiving benefits,
- for person not seeking employment, willingness to work,
- reasons why person has not sought work,
- lack of care facilities.'

2. The following point is added to paragraph 1:

'(n) atypical working times:

- shift work,
- evening work,
- night work,
- Saturday work,
- Sunday work.'

3. Paragraph 2, third indent, is replaced by the following:

- '— the volume of an ad hoc module shall be limited to 11 variables.'

4. The following paragraph shall be added:

'4. On a proposal from the Commission, a list of variables, hereinafter referred to as "structural variables", may be identified from among the survey characteristics specified in paragraph 1 which need to be surveyed only as annual averages with reference to 52 weeks rather than as quarterly averages. This list of structural variables, the minimum sample size and the survey frequency will be drawn up in accordance with the procedure laid down in Article 8. Spain, Finland and the United Kingdom may survey the structural variables with reference to a single quarter during a transition period until the end of 2007.'

Article 2

This Regulation shall enter into force on the 20th day following its publication in the *Official Journal of the European Union*.

This Regulation shall be binding in its entirety and directly applicable in all Member States.

SECTION 5c:

COMMISSION REGULATION 430/2005 OF THE EUROPEAN UNION

This regulation implements Council Regulation (EC) No 577/98 on the organisation of a labour force sample survey in the Community concerning the codification to be used for data transmission from 2006 onwards and the use of a sub-sample for the collection of data on structural variables.

Having regard to Council Regulation (EC) No 577/98 of 9 March 1998 on the organisation of a labour force sample survey in the Community, and in particular Articles 3, 4 and 4 thereof, Whereas:

(1) In accordance with Article 4 of Regulation (EC) No 577/98 implementing measures are necessary in order to define the codification of the variables to be used for the data transmission.

(2) Under Article 4 of Regulation (EC) No 577/98 a list of variables, hereinafter referred to as structural variables, may be identified from among the survey characteristics which need to be surveyed only as annual averages with reference to 52 weeks rather than as quarterly averages. Therefore the conditions for the use of a sub-sample for the collection of data on structural variables should be laid down.

(3) In view of the importance of data on employment and unemployment, the totals for these indicators should be consistent whether they are produced from the annual sub-sample or on the basis of an annual average of the four quarterly full samples.

(4) In view of the importance of data collected in ad hoc modules, this information should be combinable with any other variable from the survey.

(5) The measures provided for in this Regulation are in accordance with the opinion of the Statistical Programme Committee established by Council Decision 89/382/EEC, Euratom, has adopted this regulation:

Article 1

The conditions for the use of a sub-sample for the collection of data on structural variables are laid down (below)

Article 2

The codes for the variables to be used for data transmission for the years 2006 onwards are laid down in Annex II.

Article 3

This Regulation shall enter into force on the twentieth day following that of its publication in the *Official Journal of the European Union*.

This Regulation shall be binding in its entirety and directly applicable in all Member States.

Conditions for the use of a sub-sample for the collection of data on structural variables

1. Yearly/quarterly variables

The word 'yearly' in the 'Periodicity' column of the Codification laid down in the next section, identifies structural variables which optionally need only to be surveyed as annual averages, using a sub-sample of independent observations with reference to 52 weeks, rather than as quarterly averages. Core variables to be surveyed each quarter are identified as 'quarterly'.

2. Representativeness of the results

For structural variables, the relative standard error (without taking design effect into account) of any yearly estimate representing 1 % or more of the working age population shall not exceed:

- (a) 9 % for countries with a population between 1 million and 20 million inhabitants and
- (b) 5 % for countries with a population of 20 million or more.

Countries with less than 1 million inhabitants are exempted from these precision requirements and structural variables should be collected for the total sample unless the sample meets requirements expressed in (a).

For countries using a sub-sample for data collection on structural variables, if more than one wave is used, the total sub-sample used shall consist of independent observations.

3. Consistency of totals

Consistency between annual sub-sample totals and full sample annual averages shall be ensured for employment, unemployment and inactive population by sex and for the following age groups: 15 to 24, 25 to 34, 35 to 44, 45 to 54, 55 +.

4. Ad hoc modules

The sample used to collect information on ad hoc modules shall also provide information on structural variables.

SECTION 5d:

COMMISSION REGULATION 377/2008 OF THE EUROPEAN UNION

This regulation implements Council Regulation (EC) No 577/98 on the organisation of a labour force sample survey in the Community as regards the codification to be used for data transmission from 2009 onwards, the use of a sub-sample for the collection of data on structural variables and the definition of the reference quarters.

Having regard to Council Regulation (EC) No 577/98 of 9 March 1998 on the organisation of a labour force sample survey in the Community¹, and in particular Articles 1 and 4(3) thereof, Whereas:

(1) Article 1 of Regulation (EC) No 577/98 requires that, in the case of a continuous survey, a list of the weeks making up the reference quarters for the survey is drawn up by the Commission.

(2) In accordance with Article 4(3) of Regulation (EC) No 577/98, implementing measures are necessary in order to define the codification of the variables to be used for the data transmission.

(3) Under Article 4(4) of Regulation (EC) No 577/98, a list of variables, hereinafter referred to as structural variables, may be identified from among the survey characteristics which need to be surveyed only as annual averages with reference to 52 weeks rather than as quarterly averages. Therefore, the conditions for the use of a sub-sample for the collection of data on structural variables should be laid down.

(4) In view of the importance of data on employment and unemployment, the totals for these indicators should be consistent whether they are produced from the annual sub-sample or on the basis of an annual average of the four quarterly full samples.

(5) In view of the importance of data collected in ad hoc modules, this information should be combinable with any other variable from the survey.

(6) Regulation (EC) No 577/98 as amended by Regulation (EC) No 1372/2007 of the European Parliament and of the Council makes the transmission of the variable 'wages from the main job' compulsory. Therefore, the codification of the variables should be amended.

(7) Commission Regulation (EC) No 430/2005 implementing Council Regulation (EC) No 577/98 on the organisation of a labour force sample survey in the Community concerning the codification to be used for data transmission from 2006 onwards and the use of a sub-sample for the collection of data on structural variables² defines the codification to be used for the data transmission from 2006 onwards. However, it is necessary to amend the coding scheme from 2009 onwards in order to take account of changes in two variables (field of highest level of education or training successfully completed and monthly pay from main job), to adapt the transmission columns accordingly and to correct some filter errors and omissions for other

¹OJ L 77, 14.3.1998, p. 3. Regulation last amended by Regulation (EC) No 1372/2007 of the European Parliament and of the Council (OJ L 315, 3.12.2007, p. 42)

² OJ L 71, 17.3.2005, p. 36. Regulation last amended by Regulation (EC) No 973/2007 (OJ L 216, 21.8.2007, p. 10).

variables. Commission Regulation (EC) No 430/2005 should therefore be repealed with effect from 1 January 2009.

(8) The measures provided for in this Regulation are in accordance with the opinion of the Statistical Programme Committee established by Council Decision 89/382/EEC, Euratom³, has adopted this regulation:

Article 1

The conditions for the use of a sub-sample for the collection of data on structural variables are laid down in Annex I.

Article 2

The definition of the reference quarters to be applied from 2009 is laid down in Annex II.

Article 3

The codes for the variables to be used for the data transmission for the years 2009 onwards are laid down in Annex III.

Article 4

Regulation (EC) No 430/2005 shall be repealed with effect from 1 January 2009.

Article 5

This Regulation shall enter into force on the twentieth day following that of its publication in the *Official Journal of the European Union*.

It shall apply from 1 January 2009. This Regulation shall be binding in its entirety and directly applicable in all Member States.

ANNEX I

1. Yearly/quarterly variables

The word 'yearly' in the 'Periodicity' column of the Codification laid down in Annex III identifies structural variables which optionally need only to be surveyed as annual averages, using a sub-sample of independent observations with reference to 52 weeks, rather than as quarterly averages. Core variables to be surveyed each quarter are identified as 'quarterly'.

2. Representativeness of the results

For structural variables, the relative standard error (without taking design effect into account) of any yearly estimate representing 1 % or more of the working-age population shall not exceed:

(a) 9 % for countries with a population between 1 million and 20 million inhabitants and,

(b) 5 % for countries with a population of 20 million or more.

Countries with fewer than 1 million inhabitants are exempted from these precision requirements, and structural variables should be collected for the total sample unless the sample meets the requirements set out in (a).

³ OJL 181, 28.6.1989, p. 47

For countries using a sub-sample for data collection on structural variables, if more than one wave is used, the total subsample used shall consist of independent observations.

3. Consistency of totals

Consistency between annual sub-sample totals and full-sample annual averages shall be ensured for employment, unemployment and inactive population by sex and for the following age groups: 15 to 24, 25 to 34, 35 to 44, 45 to 54, 55 +.

4. Ad hoc modules

The sample used to collect information on ad hoc modules shall also provide information on structural variables.

ANNEX II

(a) Quarters of each year refer to the 12 months of the year, so that January, February and March belong to the first quarter, April, May and June to the second quarter, July, August and September to the third quarter and October, November and December to the fourth quarter.

(b) The reference weeks are allocated to the reference quarters so that a week belongs to the quarter as defined in (a) to which at least four days of that week belong, unless this results in the first quarter of the year consisting of only 12 weeks. When that occurs, the quarters of the year in question will be formed by consecutive blocks of 13 weeks.

(c) When, according to (b), a quarter consists of 14 weeks instead of 13 weeks the Member States should attempt to spread the sample over all of the 14 weeks.

(d) If it is not feasible to spread the sample to cover all 14 weeks of the quarter, the Member State concerned may skip one week of that quarter (i.e. not cover it). The week to be skipped should be typical with regard to unemployment, employment and average actual hours worked and should be part of a month containing five Thursdays.

(e) The first quarter of 2009 shall start on Monday, 29 December 2008. Until the end of 2011, Member States running the Labour Force Survey along with other surveys as one single integrated survey may define the start of reference quarters one week earlier than laid down in (a), (b) and (c).

**SECTION 6:
EU LABOUR FORCE SURVEY - DATA CODIFICATION 2009**

| Eurostat Name | Column | Periodicity | Code | Description | Filter/Remarks |
|---------------|--------|-------------|-------|---|----------------|
| HHSEQNUM | 1/2 | QUARTERLY | | DEMOGRAPHIC BACKGROUND | everybody |
| | | | | <i>Sequence number in the household (it should remain the same for all waves)</i> | |
| HHLINK | 3 | YEARLY | 01-98 | Two-digit sequence number allocated to each member of the household | HHTYPE =1,3 |
| | | | 1 | Reference person | |
| | | | 2 | Spouse (or cohabiting partner) of reference person | |
| | | | 3 | Child of reference person (or of his/her spouse or cohabiting partner) | |
| | | | 4 | Ascendant relative of reference person (or of his/her spouse or cohabiting partner) | |
| | | | 5 | Other relative | |
| | | | 6 | Other | |
| HHSPOU | 4/5 | YEARLY | | <i>Sequence number of spouse or cohabiting partner</i> | HHTYPE =1,3 |
| | | | 01-98 | Sequence number of spouse or cohabiting partner in the household | |
| | | | 99 | Not applicable (person does not belong to a private household, or has no partner, or the partner does not belong to this private household) | |
| HHFATH | 6/7 | YEARLY | | <i>Sequence number of father</i> | HHTYPE =1,3 |
| | | | 01-98 | Sequence number of father in the household | |
| | | | 99 | Not applicable (person does not belong to a private household, or the father does not belong to this private household) | |
| HHMOTH | 8/9 | YEARLY | | <i>Sequence number of mother</i> | HHTYPE =1,3 |
| | | | 01-98 | Sequence number of mother in the household | |
| | | | 99 | Not applicable (person does not belong to a private household, or the mother does not belong to this private household) | |
| SEX | 10 | QUARTERLY | | Sex | everybody |
| YEARBIR | 11/14 | QUARTERLY | | <i>Year of birth</i> | everybody |
| | | | | The 4 digits of year of birth are entered | |
| DATEBIR | 15 | QUARTERLY | | <i>Date of birth in relation to the end of reference period</i> | everybody |
| | | | 1 | Person's birthday falls between 1 January and the end of the reference week | |
| | | | 2 | Person's birthday falls after the end of the reference week | |
| MARSTAT | 16 | YEARLY | | <i>Marital status</i> | everybody |
| | | | 1 | Single | |
| | | | 2 | Married | |
| | | | 3 | Widowed | |
| | | | 4 | Divorced or legally separated | |
| | | | blank | No answer | |
| NATIONAL | 17/18 | QUARTERLY | | <i>Nationality</i> | everybody |

Labour Force Survey - United Kingdom

| | | | | | |
|----------|-------|-----------|-------|--|---------------------------------|
| YEARESID | 19/20 | YEARLY | | For coding, see ISO country classification (Annex IV) <i>Years of residence in this Country</i> | Everybody |
| | | | 00 | Born in this Country | |
| | | | 01-99 | Number of years of residence in this country | |
| | | | blank | No answer | |
| COUNTRYB | 21/22 | QUARTERLY | | <i>Country of birth</i> | YEARESID≠00 |
| | | | 99 | For coding, see ISO country classification (Annex IV) Not applicable (Col.19/20=00) | |
| | | | blank | No answer | |
| PROXY | 23 | QUARTERLY | | <i>Nature of participation in the survey</i> | everybody aged 15 years or more |
| | | | 1 | Direct participation | |
| | | | 2 | Participation via another member of the household | |
| | | | 9 | Not applicable (child less than 15 years old) | |
| | | | blank | No answer | |
| | | | | LABOUR STATUS | |
| WSTATOR | 24 | QUARTERLY | | <i>Labour status during the reference week</i> | everybody aged 15 years or more |
| | | | 1 | Did any work for pay or profit during the reference week - one hour or more (including family workers but excluding conscripts on compulsory military or community service) | |
| | | | 2 | Was not working but had a job or business from which he/she was absent during the reference week (including family workers but excluding conscripts on compulsory military or community service) | |
| | | | 3 | Was not working because on lay-off | |
| | | | 4 | Was a conscript on compulsory military or community service | |
| | | | 5 | Other (15 years or more) who neither worked nor had a job or business during the reference week | |
| | | | 9 | Not applicable (child less than 15 years old) | |
| NOWKREAS | 25/26 | QUARTERLY | | <i>Reason for not having worked at all though having a job</i> | WSTATOR=2 |
| | | | 00 | Bad weather | |
| | | | 01 | Slack work for technical or economic reasons | |
| | | | 02 | Labour dispute | |
| | | | 03 | School education or training | |
| | | | 04 | Own illness, injury or temporary disability | |
| | | | 05 | Maternity leave | |
| | | | 06 | Parental leave | |
| | | | 07 | Holidays | |
| | | | 08 | Compensation leave (within the framework of working time banking or an annualised hours contract) | |
| | | | 09 | Other reasons (e.g. personal or family responsibilities) | |
| | | | 99 | Not applicable (WSTATOR=1,3-5,9) | |
| | | | | EMPLOYMENT CHARACTERISTICS OF THE MAIN JOB | |
| STAPRO | 27 | QUARTERLY | | <i>Professional status</i> | WSTATOR=1,2 |
| | | | 1 | Self-employed with employees | |
| | | | 2 | Self-employed without employees | |
| | | | 3 | Employee | |
| | | | 4 | Family worker | |
| | | | 9 | Not applicable (WSTATOR=3-5,9) | |
| | | | blank | No answer | |

Labour Force Survey - United Kingdom

| | | | | | |
|----------|-------|-----------|--|--|---|
| SIGNISAL | 28 | QUARTERLY | 1 2 3 4 9 | <i>Continuing receipt of the wage or salary</i> Absent for up to and including 3 months Absent for more than 3 months and receiving a wage, salary or social allowances corresponding to half or more of the salary Absent for more than 3 months and receiving a wage, salary or social allowances corresponding to less than half of the salary Don't know Not applicable ((WSTATOR ≠2 or NOWKREAS = 04 or NOWKREAS = 05 or STAPRO ≠3) and WSTATOR ≠ 3) | (WSTATOR = 2 and NOWKREAS ≠04 and NOWKREAS≠ 05 and STAPRO=3) or WSTATOR = 3 |
| NACE3D | 29/31 | QUARTERLY | 000 blank | <i>Economic activity of the local unit</i> NACE Rev. 2 coded at 2 or if possible 3 digit level Not applicable (WSTATOR=3-5,9) No answer | WSTATOR=1,2 |
| ISCO4D | 32/35 | QUARTERLY | 9999 blank | <i>Occupation</i> ISCO-88 (COM) coded at 3 or if possible 4 digit level Not applicable (WSTATOR=3-5,9) No answer | WSTATOR=1,2 |
| SUPVISOR | 36 | YEARLY | 1 2 9 blank | <i>Supervisory responsibilities</i> Yes No STAPRO ≠ 3 No answer | STAPRO = 3 |
| SIZEFIRM | 37/38 | YEARLY | 01-10 11 12 13 14 15 99 blank | <i>Number of persons working at the local unit</i> Exact number of persons, if between 1 and 10 11 to 19 persons 20 to 49 persons 50 persons or more Do not know but less than 11 persons Do not know but more than 10 persons Not applicable (STAPRO=2,9) No answer | STAPRO=1,3,4, blank |
| COUNTRYW | 39/40 | QUARTERLY | 99 blank | <i>Country of place of work</i> For coding, see ISO country classification (Annex IV) Not applicable (WSTATOR=3-5,9) No answer | WSTATOR=1,2 |
| REGIONW | 41/42 | QUARTERLY | 99 blank | <i>Region of place of work</i> NUTS 2 Not applicable (WSTATOR=3-5,9) No answer | WSTATOR=1,2 |
| YSTARTWK | 43/46 | QUARTERLY | 9999 blank | <i>Year in which person started working for this employer or as self-employed</i> Enter the 4 digits of the year concerned Not applicable (WSTATOR=3-5,9) No answer | WSTATOR=1,2 |
| MSTARTWK | 47/48 | QUARTERLY | 01-12 99 blank | <i>Month in which person started working for this employer or as self-employed</i> Enter the number of the month concerned Not applicable (YSTARTWK=9999,blank or REFYEAR-YSTARTWK>2) No answer | YSTARTWK≠99 99, blank & REFYEAR - YSTARTWK<= 2 |
| WAYJFOUN | 49 | YEARLY | | <i>Involvement of the public employment office at any</i> | STAPRO = 3 & |

Labour Force Survey - United Kingdom

| | | | | | |
|----------|----|-----------|-------|---|--|
| | | | 0 | <i>moment in finding the present job</i> | has started this job in the last 12 months |
| | | | 1 | No | |
| | | | 9 | Yes | |
| | | | blank | STAPRO ≠ 3 or has started this job more than 1 year ago | |
| FTPT | 50 | QUARTERLY | | No answer | |
| | | | | <i>Full-time / Part-time distinction</i> | WSTATOR=1,2 |
| | | | 1 | Full-time job | |
| | | | 2 | Part-time job | |
| | | | 9 | WSTATOR≠1,2 | |
| | | | blank | No answer | |
| FTPTREAS | 51 | YEARLY | | <i>Reasons for the part-time work</i> | FTPT=2 |
| | | | | Part-time job is taken because: | |
| | | | 1 | Person is undergoing school education or training | |
| | | | 2 | Of own illness or disability | |
| | | | 3 | Looking after children or incapacitated adults | |
| | | | 4 | Other personal or family reasons | |
| | | | 5 | Person could not find a full-time job | |
| | | | 6 | Of other reasons | |
| | | | 9 | Not applicable (FTPT≠2) | |
| | | | blank | No answer | |
| TEMP | 52 | QUARTERLY | | <i>Permanency of the job</i> | STAPRO=3 |
| | | | 1 | Person has a permanent job or work contract of unlimited duration | |
| | | | 2 | Person has temporary job/work contract of limited duration | |
| | | | 9 | Not applicable (STAPRO≠3) | |
| | | | blank | No answer | |
| TEMPREAS | 53 | YEARLY | | <i>Reasons for having a temporary job/work contract of limited duration</i> | TEMP =2 |
| | | | | Person has temporary job/work contract of limited duration because: | |
| | | | 1 | It is a contract covering a period of training (apprentices, trainees, research assistants, etc.) | |
| | | | 2 | Person could not find a permanent job | |
| | | | 3 | Person did not want a permanent job | |
| | | | 4 | It is a contract for a probationary period | |
| | | | 9 | Not applicable (TEMP≠2) | |
| | | | blank | No answer | |
| TEMPDUR | 54 | QUARTERLY | | <i>Total duration of temporary job or work contract of limited duration</i> | TEMP=2 |
| | | | 1 | Less than one month | |
| | | | 2 | 1 to 3 months | |
| | | | 3 | 4 to 6 months | |
| | | | 4 | 7 to 12 months | |
| | | | 5 | 13 to 18 months | |
| | | | 6 | 19 to 24 months | |
| | | | 7 | 25 to 36 months | |
| | | | 8 | More than 3 years | |
| | | | 9 | Not applicable (TEMP≠2) | |
| | | | blank | No answer | |
| TEMPAGCY | 55 | YEARLY | | <i>Contract with a temporary employment agency</i> | STAPRO=3 |
| | | | 0 | No | |
| | | | 1 | Yes | |
| | | | 9 | Not applicable (STAPRO≠3) | |
| | | | blank | No answer | |

Labour Force Survey - United Kingdom

| | | | | ATYPICAL WORK | |
|----------|-------|-----------|-------|---|---------------------------|
| SHIFTWK | 56 | YEARLY | | <i>Shift work</i> | STAPRO=3 |
| | | | 1 | Person does shift work | |
| | | | 3 | Person never does shift work | |
| | | | 9 | Not applicable (STAPRO ≠ 3) | |
| | | | blank | No answer | |
| EVENWK | 57 | YEARLY | | <i>Evening work</i> | WSTATOR=1 or WSTATOR=2 |
| | | | 1 | Person usually works in the evening | |
| | | | 2 | Person sometimes works in the evening | |
| | | | 3 | Person never works in the evening | |
| | | | 9 | Not applicable (WSTATOR=3-5,9) | |
| | | | blank | No answer | |
| NIGHTWK | 58 | YEARLY | | <i>Night work</i> | WSTATOR=1 or WSTATOR=2 |
| | | | 1 | Person usually works at night | |
| | | | 2 | Person sometimes works at night | |
| | | | 3 | Person never works at night | |
| | | | 9 | Not applicable (WSTATOR=3-5,9) | |
| | | | blank | No answer | |
| SATWK | 59 | YEARLY | | <i>Saturday work</i> | WSTATOR=1 or WSTATOR=2 |
| | | | 1 | Person usually works on Saturdays | |
| | | | 2 | Person sometimes works on Saturdays | |
| | | | 3 | Person never works on Saturdays | |
| | | | 9 | Not applicable (WSTATOR=3-5,9) | |
| | | | blank | No answer | |
| SUNWK | 60 | YEARLY | | <i>Sunday work</i> | WSTATOR=1 or WSTATOR=2 |
| | | | 1 | Person usually works on Sundays | |
| | | | 2 | Person sometimes works on Sundays | |
| | | | 3 | Person never works on Sundays | |
| | | | 9 | Not applicable (WSTATOR=3-5,9) | |
| | | | blank | No answer | |
| | | | | HOURS WORKED | |
| HWUSUAL | 61/62 | QUARTERLY | | <i>Number of hours per week usually worked in the main job</i> | WSTATOR=1,2 |
| | | | 00 | Usual hours cannot be given because hours worked vary considerably from week to week or from month to month | |
| | | | 01-98 | Number of hours usually worked in the main job | |
| | | | 99 | Not applicable (WSTATOR=3-5,9) | |
| | | | blank | No answer | |
| HWACTUAL | 63/64 | QUARTERLY | | <i>Number of hours actually worked during the reference week in the main job</i> | WSTATOR=1,2 |
| | | | 00 | Person having a job or business and not having worked at all in the main activity during the reference week (WSTATOR=2) | |
| | | | 01-98 | Number of hours actually worked in the main job during the reference week | |
| | | | 99 | Not applicable (WSTATOR=3-5,9) | |
| | | | blank | No answer | |
| HWOVERP | 65/66 | QUARTERLY | | <i>Paid overtime in the reference week in the main job</i> | STAPRO=3 |
| | | | 00-98 | Number of paid overtime hours | |
| | | | 99 | Not applicable (STAPRO≠3) | |
| | | | blank | No answer | |
| HWOVERPU | 67/68 | QUARTERLY | | <i>Unpaid overtime in the reference week in the main job</i> | STAPRO=3 |
| | | | 00-98 | Number of unpaid overtime hours | |

Labour Force Survey - United Kingdom

| | | | | | |
|----------|---|-----------|-------|--|--|
| HOURREAS | 69/70 | QUARTERLY | 99 | Not applicable (STAPRO≠3) | HWUSUAL = 00-98 & HWACTUAL = 00-98 & WSTATOR = 1 |
| | | | blank | No answer | |
| | | | | <i>Main reason for hours actually worked during the reference week being different from the person's usual hours</i> | |
| | | | | Person has worked more than usual due to: | |
| | | | 01 | - variable hours (e.g. flexible working hours) | |
| | | | 16 | - overtime | |
| | | | 02 | - other reasons | |
| | | | | Person has worked less than usual due to: | |
| | | | 03 | - bad weather | |
| | | | 04 | - slack work for technical or economic reasons | |
| | | | 05 | - labour dispute | |
| | | | 06 | - education or training | |
| | | | 07 | - variable hours (e.g. flexible working hours) | |
| | | | 08 | - own illness, injury or temporary disability | |
| | | | 09 | - maternity or parental leave | |
| 10 | - special leave for personal or family reasons | | | | |
| 11 | - annual holidays | | | | |
| 12 | - bank holidays | | | | |
| 13 | - start of/change in job during reference week | | | | |
| 14 | - end of job without taking up a new one during reference week | | | | |
| 15 | - other reasons | | | | |
| 97 | Person having worked usual hours during the reference week (HWUSUAL=HWACTUAL=01-98) | | | | |
| 98 | Person whose hours vary considerably from week to week or month to month and who did not state a reason for a divergence between the actual and usual hours (HWUSUAL=00 & HOURREAS#01-16) | | | | |
| 99 | Not applicable (WSTATOR=2-5,9 or HWUSUAL=blank or HWACTUAL= blank) | | | | |
| blank | No answer | | | | |
| WISHMORE | 71 | QUARTERLY | | <i>Wish to work usually more than the current number of hours</i> | (WSTATOR=1 or WSTATOR=2) |
| | | | 0 | No | |
| | | | 1 | Yes | |
| | | | 9 | Not applicable (WSTATOR=3-5, 9) | |
| WAYMORE | 72 | YEARLY | blank | No answer | WISHMORE=1 |
| | | | | <i>Way how person wants to work more hours</i> | |
| | | | 1 | Through an additional job | |
| | | | 2 | Through a job working more hours than the present job | |
| | | | 3 | Only within the present job | |
| | | | 4 | In any of the above ways | |
| 9 | Not applicable (WISHMORE≠1) | | | | |
| HWWISH | 73/74 | QUARTERLY | blank | No answer | WSTATOR=1 or WSTATOR=2 |
| | | | | <i>Number of hours that the person would like to work in total</i> | |
| | | | 01-98 | Number of hours wished to work in total | |
| | | | 99 | Not applicable (WSTATOR=3-5,9) | |
| HOMEWK | 75 | YEARLY | blank | No answer | WSTATOR=1 or WSTATOR=2 |
| | | | | <i>Working at home</i> | |
| | | | 1 | Person usually works at home | |
| | | | 2 | Person sometimes works at home | |
| | | | 3 | Person never works at home | |
| 9 | Not applicable (WSTATOR=3-5,9) | | | | |

Labour Force Survey - United Kingdom

| | | | | | |
|----------|-------|-----------|-------|--|---------------------------|
| LOOKOJ | 76 | QUARTERLY | blank | No answer <i>Looking for another job</i> | WSTATOR=1 or WSTATOR=2 |
| | | | 0 | Person is not looking for another job | |
| | | | 1 | Person is looking for another job | |
| | | | 9 | Not applicable (WSTATOR=3-5,9) | |
| LOOKREAS | 77 | YEARLY | blank | No answer <i>Main reason for looking for another job</i> | LOOKOJ = 1 |
| | | | 1 | - risk or certainty of loss or termination of present job | |
| | | | 2 | - actual job is considered as a transitional job | |
| | | | 3 | - seeking an additional job to add more hours to those worked in present job | |
| | | | 4 | - seeking a job with more hours worked than in present job | |
| | | | 5 | - seeking a job with fewer hours worked than in present job | |
| | | | 6 | - wish to have better working conditions (e.g. pay, working or travel time, quality of work) | |
| | | | 7 | - of other reasons | |
| | | | 9 | Not applicable (LOOKOJ ≠ 1) | |
| | | | blank | No answer | |
| EXIST2J | 78 | QUARTERLY | | SECOND JOB <i>Existence of more than one job or business</i> | WSTATOR=1 or WSTATOR=2 |
| | | | 1 | Person had only one job or business during the reference week | |
| | | | 2 | Person had more than one job or business during the reference week (not due to change of job or business) | |
| | | | 9 | Not applicable (WSTATOR=3-5,9) | |
| STAPRO2J | 79 | QUARTERLY | blank | No answer <i>Professional status (in the second job)</i> | EXIST2J=2 |
| | | | 1 | Self-employed with employees | |
| | | | 2 | Self-employed without employees | |
| | | | 3 | Employee | |
| | | | 4 | Family worker | |
| | | | 9 | Not applicable (EXIST2J=1,9 blank) | |
| | | | blank | No answer | |
| NACE2J2D | 80/81 | QUARTERLY | | <i>Economic activity of the local unit (in the second job)</i> NACE Rev. 2 | EXIST2J=2 |
| | | | 00 | Not applicable (EXIST2J=1,9,blank) | |
| | | | blank | No answer | |
| HWACTUA2 | 82/83 | QUARTERLY | | <i>Number of hours actually worked during the reference week in the second job</i> | EXIST2J=2 |
| | | | 00 | Person not having worked in the second job during the reference week | |
| | | | 01-98 | Number of hours actually worked in the second job during the reference week | |
| | | | 99 | Not applicable (EXIST2J=1,9, blank) | |
| | | | blank | No answer | |
| EXISTPR | 84 | QUARTERLY | | PREVIOUS WORK EXPERIENCE OF PERSON NOT IN EMPLOYMENT <i>Existence of previous employment experience</i> | WSTATOR=3-5 |
| | | | 0 | Person has never been in employment (purely occasional work, such as vacation work, compulsory military or community service are not to be considered as employment) | |
| | | | 1 | Person has already been in employment (purely | |

Labour Force Survey - United Kingdom

| | | | | | |
|----------|-------|---|-------|---|--|
| YEARPR | 85/88 | QUARTERLY | 9 | occasional work, such as vacation work, compulsory military or community service are not to be considered as employment) | EXISTPR=1 |
| | | | blank | Not applicable (WSTATOR=1,2 or 9) No answer <i>Year in which person last worked</i> Enter the 4 digits of the year in which person last worked | |
| MONTHPR | 89/90 | QUARTERLY | 9999 | Not applicable (EXISTPR=0,9,blank) | YEARPR≠9999, blank & REFYEAR- YEARPR <= 2 |
| | | | blank | No answer <i>Month in which person last worked</i> Enter the number of the month in which person last worked | |
| LEAVREAS | 91/92 | YEARLY | 01-12 | Not applicable (YEARPR=9999, blank or REFYEAR-YEARPR>2) | EXISTPR=1 and REFYEAR - YEARPR<8 |
| | | | 99 | No answer <i>Main reason for leaving last job or business</i> | |
| | | | blank | Dismissed or made redundant | |
| | | | 00 | A job of limited duration has ended | |
| | | | 01 | Looking after children or incapacitated adults | |
| | | | 02 | Other personal or family responsibilities | |
| | | | 03 | Own illness or disability | |
| | | | 04 | Education or training | |
| | | | 05 | Early retirement | |
| | | | 06 | Normal retirement | |
| | | | 07 | Compulsory military or community service | |
| STAPROPR | 93 | QUARTERLY only if having worked in the last 12 months YEARLY otherwise | 08 | Other reasons | EXISTPR=1 and REFYEAR - YEARPR<8 |
| | | | 09 | Not applicable (EXISTPR=0,9,blank, or EXISTPR=1 and did not work in last 8 years) | |
| | | | 99 | No answer <i>Professional status in last job</i> | |
| | | | blank | Self-employed with employees | |
| | | | 1 | Self-employed without employees | |
| NACEPR2D | 94/95 | QUARTERLY if having worked in the last 12 months, YEARLY otherwise | 2 | Employee | EXISTPR=1 and REFYEAR - YEARPR<8 |
| | | | 3 | Family worker | |
| | | | 4 | Not applicable (EXISTPR=0,9,blank, or EXISTPR=1 and did not work in last 8 years) | |
| ISCOPR3D | 96/98 | QUARTERLY if having worked in the last 12 months, YEARLY otherwise | 9 | No answer <i>Economic activity of the local unit in which person last worked</i> NACE Rev. 2 | EXISTPR=1 and REFYEAR - YEARPR<8 |
| | | | blank | Not applicable (EXISTPR=0,9,blank, or EXISTPR=1 and did not work in last 8 years) | |
| | | | 00 | No answer <i>Occupation of last job</i> ISCO-88 (COM) | |
| SEEKWORK | 99 | QUARTERLY | 999 | Not applicable (EXISTPR=0,9,blank, or EXISTPR=1 and did not work in last 8 years) | EXISTPR=1 and REFYEAR - YEARPR<8 |
| | | | blank | No answer SEARCH FOR EMPLOYMENT <i>Seeking employment during previous four weeks</i> | |
| | | | 1 | Person has already found a job which will start within a period of at most 3 months | |
| | | | 2 | Person has already found a job which will start in more than 3 months and is not seeking employment | (WSTATOR=3-5 or SIGNISAL=3) and Age<75 |

Labour Force Survey - United Kingdom

| | | | | | |
|----------|-----|-----------|--|--|------------------------------|
| SEEKREAS | 100 | YEARLY | 3 4 9 | Person is not seeking employment and has not found any job to start later Person is seeking employment Not applicable (WSTATOR=1,2 or 9 and SIGNISAL ≠ 3) or Age equal or greater than 75 <i>Reasons for not searching an employment</i> <i>Person is not seeking employment because:</i> | SEEKWORK=3 |
| | | | 1 2 3 4 5 6 7 8 9 | - awaiting recall to work (persons on lay-off) - of own illness or disability - looking after children or incapacitated adults - of other personal or family responsibilities - of education or training - of retirement - of belief that no work is available - of other reasons | |
| SEEKTYPE | 101 | QUARTERLY | 9 blank | Not applicable (SEEKWORK≠3) No answer <i>Type of employment sought (or found)</i> The employment sought (for SEEKWORK=1, 2 the employment found) is: | SEEKWORK=1, 2, 4 or LOOKOJ=1 |
| | | | 1 2 3 4 5 6 9 | as self-employed as employee : - and only full-time job is looked for (or has already been found) - and full-time job is sought, but if not available, part-time job will be accepted - and part-time job is sought, but if not available, full-time job will be accepted - and only part-time job is looked for (or has already been found) - and person did not state whether full-time or part-time job is looked for (or has already been found) | |
| SEEKDUR | 102 | QUARTERLY | 9 Blank | Not applicable (SEEKWORK ≠ 1,2,4 and LOOKOJ ≠ 1) No answer <i>Duration of search for employment</i> | SEEKWORK=1, 4 or LOOKOJ=1 |
| | | | 0 1 2 3 4 5 6 7 8 9 | Search not yet started Less than 1 month 1-2 months 3-5 months 6-11 months 12-17 months 18-23 months 24-47 months 4 years or longer | |
| METHODA | 103 | QUARTERLY | 9 Blank | Not applicable (SEEKWORK ≠ 1,4 and LOOKOJ ≠ 1) No answer METHODS USED DURING PREVIOUS FOUR WEEKS TO FIND WORK <i>Contacted public employment office to find work</i> | SEEKWORK=4 or LOOKOJ=1 |
| | | | 0 1 | No Yes | |
| METHODB | 104 | QUARTERLY | 9 Blank | Not applicable (SEEKWORK ≠ 4 and LOOKOJ ≠ 1) No answer <i>Contacted private employment agency to find work</i> | SEEKWORK=4 or LOOKOJ=1 |
| | | | 0 1 9 | No Yes Not applicable (SEEKWORK ≠ 4 and LOOKOJ ≠ 1) | |

Labour Force Survey - United Kingdom

| | | | | | |
|----------|-----|-----------|-------------|---|---------------------------|
| METHODC | 105 | QUARTERLY | 0 1 9 | <i>Applied to employers directly</i> No Yes Not applicable (SEEKWORK ≠ 4 and LOOKOJ ≠ 1) | SEEKWORK=4 or LOOKOJ=1 |
| METHODD | 106 | QUARTERLY | 0 1 9 | <i>Asked friends, relatives, trade unions, etc.</i> No Yes Not applicable (SEEKWORK ≠ 4 and LOOKOJ ≠ 1) | SEEKWORK=4 or LOOKOJ=1 |
| METHODE | 107 | QUARTERLY | 0 1 9 | <i>Inserted or answered advertisements in newspapers or journals</i> No Yes Not applicable (SEEKWORK ≠ 4 and LOOKOJ ≠ 1) | SEEKWORK=4 or LOOKOJ=1 |
| METHODF | 108 | QUARTERLY | 0 1 9 | <i>Studied advertisements in newspapers or journals</i> No Yes Not applicable (SEEKWORK ≠ 4 and LOOKOJ ≠ 1) | SEEKWORK=4 or LOOKOJ=1 |
| METHODG | 109 | QUARTERLY | 0 1 9 | <i>Took a test, interview or examination</i> No Yes Not applicable (SEEKWORK ≠ 4 and LOOKOJ ≠ 1) | SEEKWORK=4 or LOOKOJ=1 |
| METHODH | 110 | QUARTERLY | 0 1 9 | <i>Looked for land, premises or equipment</i> No Yes Not applicable (SEEKWORK ≠ 4 and LOOKOJ ≠ 1) | SEEKWORK=4 or LOOKOJ=1 |
| METHODI | 111 | QUARTERLY | 0 1 9 | <i>Looked for permits, licences, financial resources</i> No Yes Not applicable (SEEKWORK ≠ 4 and LOOKOJ ≠ 1) | SEEKWORK=4 or LOOKOJ=1 |
| METHODJ | 112 | QUARTERLY | 0 1 9 | <i>Awaiting the results of an application for a job</i> No Yes Not applicable (SEEKWORK ≠ 4 and LOOKOJ ≠ 1) | SEEKWORK=4 or LOOKOJ=1 |
| METHODK | 113 | QUARTERLY | 0 1 9 | <i>Waiting for a call from a public employment office</i> No Yes Not applicable (SEEKWORK ≠ 4 and LOOKOJ ≠ 1) | SEEKWORK=4 or LOOKOJ=1 |
| METHODL | 114 | QUARTERLY | 0 1 9 | <i>Awaiting the results of a competition for recruitment to the public sector</i> No Yes Not applicable (SEEKWORK ≠ 4 and LOOKOJ ≠ 1) | SEEKWORK=4 or LOOKOJ=1 |
| METHODM | 115 | QUARTERLY | 0 1 9 | <i>Other method used</i> No Yes Not applicable (SEEKWORK ≠ 4 and LOOKOJ ≠ 1) | SEEKWORK=4 or LOOKOJ=1 |
| WANTWORK | 116 | QUARTERLY | 1 2 | <i>Willingness to work for person not seeking employment</i> Person is not seeking employment: - but would nevertheless like to have work - and does not want to have work | SEEKWORK=3 |

Labour Force Survey - United Kingdom

| | | | | | |
|-----------|-----|-----------|------------|---|----------------------------------|
| AVAILBLE | 117 | QUARTERLY | 9 Blank | Not applicable (SEEKWORK≠3) No answer | |
| | | | | <i>Availability to start working within two weeks</i> | |
| | | | | If work were found now: | |
| | | | 1 | Person could start to work immediately (within 2 weeks) | SEEKWORK=1, 4 or |
| | | | 2 | Person could not start to work immediately (within 2 weeks) | WANTWORK=1, blank or |
| | | | 9 | Not applicable (SEEKWORK≠1,4 and WANTWORK≠1,blank and WISHMORE≠1) | WISHMORE=1 |
| AVAIRESAS | 118 | YEARLY | 9 Blank | Not applicable (SEEKWORK≠1,4 and WANTWORK≠1,blank and WISHMORE≠1) No answer | |
| | | | | <i>Reasons for not being available to start working within 2 weeks</i> | AVAILBLE=2 |
| | | | | Person could not start to work immediately (within 2 weeks) because: | |
| | | | 1 | - he/she must complete education or training | |
| | | | 2 | - he/she must complete compulsory military or community service | |
| | | | 3 | - he/she cannot leave present employment within two weeks due to period of notice | |
| | | | 4 | - of personal or family responsibilities (including maternity) | |
| | | | 5 | - of own illness or incapacity | |
| | | | 6 | - of other reasons | |
| | | | 9 | Not applicable (AVAILBLE≠2) | |
| PRESEEK | 119 | YEARLY | Blank | No answer | |
| | | | | <i>Situation immediately before person started to seek employment (or was waiting for new job to start)</i> | SEEKWORK=1, 2, 4 |
| | | | 1 | Person was working (including apprentices, trainees) | |
| | | | 2 | Person was in full-time education (excluding apprentices, trainees) | |
| | | | 3 | Person was conscript on compulsory military or community service | |
| | | | 4 | Person had domestic/family responsibilities | |
| | | | 5 | Other (e.g. retired) | |
| | | | 9 | Not applicable (SEEKWORK=3, 9) | |
| | | | Blank | No answer | |
| NEEDCARE | 120 | YEARLY | Blank | No answer | |
| | | | | <i>Need for care facilities</i> | FTPTREAS=3 or SEEKREAS =3 |
| | | | | Person is not searching for a job or is working part time because: | |
| | | | 1 | suitable care services for children are not available or affordable | |
| | | | 2 | suitable care services for ill, disabled, elderly are not available or affordable | |
| | | | 3 | Suitable care services for both children and ill, disabled and elderly are not available or affordable. | |
| | | | 4 | Care facilities do not influence decision for working part time or not searching for a job | |
| | | | 9 | Not applicable (FTPTREAS≠3 and SEEKREAS ≠3) | |
| | | | Blank | No answer | |
| REGISTER | 121 | YEARLY | Blank | No answer | |
| | | | | <i>Registration at a public employment office</i> | everybody aged 15 to 74 years |
| | | | 1 | Person is registered at a public employment office and receives benefit or assistance | |
| | | | 2 | Person is registered at a public employment office but does not receive benefit or assistance | |
| | | | 3 | Person is not registered at a public employment office but receives benefit or assistance | |
| | | | 4 | Person is not registered at a public employment office and does not receive benefit or assistance | |
| | | | 9 | Not applicable (person aged less than 15 years or older than 75) | |
| | | | Blank | No answer | |

Labour Force Survey - United Kingdom

| | | | | MAIN LABOUR STATUS | |
|------------------------|---------|-----------|--|--|---|
| MAINSTAT (optional) | 122 | YEARLY | 1 2 3 4 5 6 7 8 9 blank | <i>Main status</i> Carries out a job or profession, including unpaid work for a family business or holding, including an apprenticeship or paid traineeship, etc. Unemployed Pupil, student, further training, unpaid work experience In retirement or early retirement or has given up business Permanently disabled In compulsory military service Fulfilling domestic tasks Other inactive person Not applicable (child less than 15 years) No answer | everybody aged 15 years or more |
| EDUCSTAT | 123 | QUARTERLY | 1 3 2 9 blank | EDUCATION AND TRAINING <i>Student or apprentice in regular education during the last four weeks</i> Has been a student or an apprentice Person in regular education but on holidays Has not been a student or apprentice Not applicable (child less than 15 years) No answer | everybody aged 15 years or more |
| EDUCLEVL | 124 | QUARTERLY | 1 2 3 4 5 6 9 blank | <i>Level of this education or training</i> ISCED 1 ISCED 2 ISCED 3 ISCED 4 ISCED 5 ISCED 6 Not applicable (EDUCSTAT = 2, 9, blank) No answer | EDUCSTAT = 1 or 3 |
| EDUCFILD (optional) | 125/127 | YEARLY | 000 100 200 222 300 400 420 440 460 481 482 500 600 700 800 900 999 blank | <i>Field of this education or training</i> General programmes Teacher training and education science Humanities, languages and arts Foreign languages Social sciences, business and law Science, mathematics and computing Life science (including biology and environmental science) Physical science (including physics, chemistry and earth science) Mathematics and statistics Computer science Computer use Engineering, manufacturing and construction Agriculture and veterinary Health and welfare Services Unknown Not applicable (EDUCSTAT = 2, 9, blank or EDUCLEVL ≠ (3 to 6)) No answer | EDUCSTAT = 1 or 3 and EDUCLEVL = 3 to 6 |
| COURATT | 128 | QUARTERLY | | <i>Did you attend any courses, seminars, conferences or receive private lessons or instructions outside the regular education system (hereafter referred to as taught</i> | Everybody aged 15 years or more |

Labour Force Survey - United Kingdom

| | | | | | |
|---------------------|---------|-----------|--------|---|---------------------------------|
| | | | 1 | Yes | |
| | | | 2 | No | |
| | | | 9 | Not applicable (child less than 15 years) | |
| | | | blank | No answer | |
| COURLEN | 129/131 | QUARTERLY | | <i>learning activities) within the last four weeks</i> | |
| | | | | <i>Number of hours spent on all taught-learning activities within the last four weeks</i> | COURATT = 1 |
| | | | 3 | Number of hours | |
| | | | digits | | |
| | | | 999 | Not applicable (COURATT = 2, 9, blank) | |
| | | | blank | No answer | |
| COURPURP (optional) | 132 | YEARLY | | <i>Purpose of the most recent taught learning activity</i> | COURATT = 1 |
| | | | 1 | Mostly job related (professional) | |
| | | | 2 | Mostly personal/social | |
| | | | 9 | Not applicable (COURATT = 2, 9, blank) | |
| | | | blank | No answer | |
| COURFILD (optional) | 133/135 | YEARLY | | <i>Field of the most recent taught learning activity</i> | COURATT = 1 |
| | | | 000 | General programmes | |
| | | | 100 | Teacher training and education science | |
| | | | 200 | Humanities, languages and arts | |
| | | | 222 | Foreign languages | |
| | | | 300 | Social sciences, business and law | |
| | | | 400 | Science, mathematics and computing | |
| | | | 420 | Life science (including biology and environmental science) | |
| | | | 440 | Physical science (including physics, chemistry and earth science) | |
| | | | 460 | Mathematics and statistics | |
| | | | 481 | Computer science | |
| | | | 482 | Computer use | |
| | | | 500 | Engineering, manufacturing and construction | |
| | | | 600 | Agriculture and veterinary | |
| | | | 700 | Health and welfare | |
| | | | 800 | Services | |
| | | | 900 | Unknown | |
| | | | 999 | Not applicable (COURATT = 2, 9, blank) | |
| | | | blank | No answer | |
| COURWORH (optional) | 136 | YEARLY | | <i>Did the most recent taught learning activity take place during paid working hours?</i> | COURATT = 1 |
| | | | 1 | Only during paid working hours | |
| | | | 2 | Mostly during paid working hours | |
| | | | 3 | Mostly outside paid working hours | |
| | | | 4 | Only outside paid working hours | |
| | | | 5 | No job at that time | |
| | | | 9 | Not applicable (COURATT = 2, 9, blank) | |
| | | | blank | No answer | |
| HATLEVEL | 137/138 | QUARTERLY | | <i>Highest level of education or training successfully completed</i> | Everybody aged 15 years or more |
| | | | 00 | No formal education or below ISCED 1 | |
| | | | 11 | ISCED 1 | |
| | | | 21 | ISCED 2 | |
| | | | 22 | ISCED 3c (shorter than two years) | |
| | | | 31 | ISCED 3c (two years and more) | |
| | | | 32 | ISCED 3 a, b | |
| | | | 30 | ISCED 3 (without distinction a, b or c possible, 2 y+) | |

Labour Force Survey - United Kingdom

| | | | | | |
|----------|---------|--------|-------|--|---------------------------------|
| | | | 41 | ISCED 4a, b | |
| | | | 42 | ISCED 4c | |
| | | | 43 | ISCED 4 (without distinction a, b or c possible) | |
| | | | 51 | ISCED 5b | |
| | | | 52 | ISCED 5a | |
| | | | 60 | ISCED 6 | |
| | | | 99 | Not applicable (child less than 15 years) | |
| | | | Blank | No answer | |
| HATFIELD | 139/141 | YEARLY | | <i>Field of highest level of education or training successfully completed</i> | HATLEVEL = 22 to 60 |
| | | | 000 | General programmes ⁴ | |
| | | | 100 | Teacher training and education science ¹ | |
| | | | 200 | Humanities, languages and arts ¹ | |
| | | | 222 | Foreign languages ¹ | |
| | | | 300 | Social sciences, business and law ¹ | |
| | | | 400 | Science, mathematics and computing ¹ | |
| | | | 420 | Life science (including biology and environmental science) ¹ | |
| | | | 440 | Physical science (including physics, chemistry and earth science) ¹ | |
| | | | 460 | Mathematics and statistics ¹ | |
| | | | 481 | Computer science | |
| | | | 482 | Computer use | |
| | | | 500 | Engineering, manufacturing and construction ¹ | |
| | | | 600 | Agriculture and veterinary ¹ | |
| | | | 700 | Health and welfare ¹ | |
| | | | 800 | Services ¹ | |
| | | | 900 | Unknown | |
| | | | 999 | Not applicable (HATLEVEL = 00, 11, 21, 99, Blank) | |
| | | | blank | No answer | |
| HATYEAR | 142/145 | YEARLY | | <i>Year when highest level of education or training was successfully completed</i> | HATLEVEL = 11-60 |
| | | | | The 4 digits of year when highest level of education or training was successfully completed are entered | |
| | | | 9999 | Not applicable (HATLEVEL = 00, 99, blank) | |
| | | | blank | No answer | |
| | | | | SITUATION ONE YEAR BEFORE SURVEY | |
| WSTAT1Y | 146 | YEARLY | | <i>Situation with regard to activity one year before survey</i> | everybody aged 15 years or more |
| | | | 1 | Carries out a job or profession, including unpaid work for a family business or holding, including an apprenticeship or paid traineeship, etc, | |
| | | | 2 | Unemployed | |
| | | | 3 | Pupil, student, further training, unpaid work experience | |
| | | | 4 | In retirement or early retirement or has given up business | |
| | | | 5 | Permanently disabled | |
| | | | 6 | In compulsory military service | |
| | | | 7 | Fulfilling domestic tasks | |
| | | | 8 | Other inactive person | |
| | | | 9 | Not applicable (child less than 15 years) | |
| | | | blank | No answer | |
| STAPRO1Y | 147 | YEARLY | | <i>Professional status one year before survey</i> | WSTAT1Y=1 |
| | | | 1 | Self-employed with employees | |
| | | | 2 | Self-employed without employees | |

⁴ Or subdivisions of ISCED 1997 – field of education – coded on 3 digits

Labour Force Survey - United Kingdom

| | | | | | | |
|-----------|---------|-----------|----------------------|---|---|-----------|
| NACE1Y2D | 148/149 | YEARLY | 3 4 9 blank | Employee Family-worker Not applicable (WSTAT1Y≠1) No answer | Economic activity of local unit in which person was working one year before survey NACE Rev. 2 | WSTAT1Y=1 |
| | | | 00 blank | Not applicable (WSTAT1Y≠1) No answer | | |
| COUNTRY1Y | 150/151 | YEARLY | | Country of residence one year before survey For coding, see ISO country classification | Everybody aged 1 year or more | |
| | | | 99 blank | Not applicable (child less than one year old) No answer | | |
| REGION1Y | 152/153 | YEARLY | | Region of residence one year before survey NUTS 2 | Everybody aged 1 year or more | |
| | | | 99 blank | Not applicable (person who has changed country of residence or child less than one year old) No answer | | |
| INCDECIL | 154/155 | YEARLY | | INCOME Monthly (take home) pay from main job | STAPRO=3 | |
| | | | 01-10 99 Blank | Deciles order Not applicable (STAPRO ≠ 3) No answer | | |
| REFYEAR | 156/159 | QUARTERLY | | TECHNICAL ITEMS RELATING TO THE INTERVIEW Year of survey | everybody | |
| | | | | Last 4 digits of the year | | |
| REFWEEK | 160/161 | QUARTERLY | | Reference week Number of the week running from Monday to Sunday | everybody | |
| INTWEEK | 162/163 | QUARTERLY | | Interview week Number of the week running from Monday to Sunday | everybody | |
| COUNTRY | 164/165 | QUARTERLY | | Country For coding, see ISO country classification (Annex IV) | everybody | |
| REGION | 166/167 | QUARTERLY | | Region of household NUTS 2 | everybody | |
| DEGURBA | 168 | QUARTERLY | | Degree of urbanisation | everybody | |
| | | | 1 2 3 | Densely-populated area Intermediate area Thinly-populated area | | |
| HHNUM | 169/174 | QUARTERLY | | Serial number of household Serial numbers are allocated by the national statistical institutes and remain the same for all waves. Records relating to different members of the same household carry the same serial number | everybody | |
| HHTYPE | 175 | QUARTERLY | | Type of household | everybody | |
| | | | 1 2 3 | Person living in private household (or permanently in a hotel) and surveyed in this household Person living in an institution and surveyed in this institution Person living in an institution but surveyed in this private household | | |

Labour Force Survey - United Kingdom

| | | | | | |
|----------|---------|-----------|-----------|--|-------------|
| HHINST | 176 | QUARTERLY | 4 | Person living in another private household on the territory of the country but surveyed in this household of origin | HHTYPE =2,3 |
| | | | | <i>Type of institution</i> | |
| | | | 1 | Educational institution | |
| | | | 2 | Hospital | |
| | | | 3 | Other welfare institution | |
| | | | 4 | Religious institution (not already included in 1-3) | |
| | | | 5 | Workers' hostel, working quarters at building sites, student hostel, university accommodation, etc. | |
| | | | 6 | Military establishment | |
| | | | 7 | Other (e.g. prison) | |
| | | | 9 | Not applicable (HHTYPE =1,4) | |
| COEFFY | 177/182 | YEARLY | blank | No answer | everybody |
| | | | | <i>Yearly weighting factor</i> | |
| | | | 0000-9999 | Cols 177-180 contain whole numbers | |
| COEFFQ | 183/188 | QUARTERLY | 00-99 | Cols 181-182 contain decimal places | everybody |
| | | | | <i>Quarterly weighting factor</i> | |
| | | | 0000-9999 | Cols 183-186 contain whole numbers | |
| COEFFH | 189/194 | YEARLY | 00-99 | Cols 187-188 contain decimal places | everybody |
| | | | | <i>Yearly weighting factor of the sample for household characteristics (in the case of a sample of individuals)</i> | |
| | | | 0000-9999 | Cols 189-192 contain whole numbers | |
| INTWAVE | 195 | QUARTERLY | 00-99 | Cols 193-194 contain decimal places | everybody |
| | | | | <i>Sequence number of the survey wave</i> | |
| INTQUEST | 196 | QUARTERLY | 1-8 | Sequence number of the wave | everybody |
| | | | | <i>Questionnaire used</i> | |
| | | | 1 | Only core variables | |
| | | | 2 | Whole questionnaire | |

Section 7:

EXPLANATORY NOTES TO THE LFS LIST OF VARIABLES

Demographic background

Col 1/2: (HHSEQNUM) Sequence number within household

A two-digit sequence number should be allocated to each member of the household. It should remain the same for all waves. Persons re-entering the household should retain the original sequence number.

Col 3: (HHLINK) Relationship to reference person in the household

Code 1: Each private household should contain one and only one person coded as 'reference person', who must be a person aged 15 and over.

Code 2 should reflect the “de facto” situation in terms of co-habitation arrangements. It therefore does not necessarily correspond with the “de jure” situation of the household in terms of co-habitation arrangements, as recorded in Col 16 (*Marital status*).

Code 3 should not include sons and daughters in law, who should be coded 5.

Code 4 means the father or the mother of the reference person or of his/her cohabiting partner.

Col 4/5: (HHSPOU) Sequence number of spouse or cohabiting partner

The identification should be done using the sequence number which was allocated to these persons in Col 1/2 (*Sequence number in the household*).

It should reflect the “de facto” situation in terms of co-habitation arrangements. It therefore does not necessarily correspond with the “de jure” situation of the household in terms of co-habitation arrangements, as recorded in Col. 16 (*Marital status*).

Col 6/7: (HHFATH) Sequence number of father

The identification should be done using the sequence number which was allocated to these persons in Col 1/2 (*Sequence number in the household*).

No distinction should be made between biological and non-biological children in the case of adopted children or step children. Father and mother in law should be coded 99.

In case of homoparentality (parents of the same sex) the sequence number of the parents should appear in Col 6/7 and Col 8/9.

Col 8/9: (HHMOTH) Sequence number of mother

The identification should be done using the sequence number which was allocated to these persons in Col 1/2 (*Sequence number in the household*).

No distinction should be made between biological and non-biological children in the case of adopted children or step children. Father and mother in law should be coded 99.

In case of homoparentality (parents of the same sex) the sequence number of the parents should appear in Col 6/7 and Col 8/9.

Col 11/14: (YEARBIR) Year of birth

In case the respondent does not know the exact date of birth (e.g. in case of a proxy) or refuses to answer this question, an estimate should be provided.

Col 15: (DATEBIR) Date of birth in relation to the end of reference period

For persons born in the same year, those coded 1 (birthday falling between 1 January and the end of the reference week) will be, for the purpose of analysing survey results, effectively one year older than those persons coded 2 (birthday falling after the end of the reference week). This definition of age should be applied in all filters that use age.

Col 16: (MARSTAT) Marital status

Marital status is the conjugal status of each individual in relation to the marriage laws of the country (i.e. de jure status). It therefore does not necessarily correspond with the actual situation of the household in terms of co-habitation arrangements, as recorded in Col 3.

In case of borderline situations, e.g., trial separations, or registered cohabitation bestowing some but not full marital rights or duties, the prevailing national statistical convention should apply.

Some countries have a legal framework for registering partnerships (in most countries these are same-sex partnership and they have a legal status parallel to married couples). Such information has also to be treated in a harmonised way so they should be treated as married and classified under group 2 when the partnership still exists, else as 3-4 as appropriate (legal separation or death of one of the partners).

In some countries, children under a certain age cannot have a legal marital status different from “single”. To ask them this question would not be necessary, nevertheless they should be coded 1.

Col 17/18: (NATIONAL) Nationality

See country classification in Annex IV (derived from ISO)

Nationality should be interpreted as citizenship. Citizenship is defined as the particular legal bond between an individual and his/her State acquired by birth or naturalisation, whether by declaration, option, marriage or other means according to national legislation. It corresponds to the country issuing the passport.

The concept of nationality should not be mixed up with any concept of ethnic origin. For persons with dual or multiple citizenships, and who hold the citizenship of the country of residence, that citizenship should be coded.

This should be provided according to the coding given in Annex IV. If possible the exact country should be indicated; where this is not possible, one of the general groupings in bold print should be used. EU and EFTA Member States but also candidate and other European countries must be coded individually.

In case of multiple citizenship, including one citizenship of a member state of the European Union, that citizenship should be coded. In other situations the first answer of the respondent should be coded.

This should be provided according to the coding given in Annex IV. If possible the exact country should be indicated; where this is not possible, one of the general

groupings in bold print should be used. EU and EFTA Member States but also candidate and other European countries must be coded individually.

Col 19/20: (YEARESID) Years of residence in this country for persons not born in the country

The years of residence should be calculated taking as starting point the year in which the person last established his or her usual residence in the country (or, in other words, when the person last moved to the country in order to live there).

In case of an interruption in the period of residence, the starting point should be the end of this interruption only if the length of this interruption was at least one year.

For persons with less than one year's residence in this Member State, 01 should be coded; between one year and less than two years, 02; and so on. Up to 2007, people with 10 years of residence and more were coded 11. This is no longer the case from 2008 onwards.

Col 21/22: (COUNTRYB) Country of birth

In case of doubt, the country of birth should be defined as the country of residence of the mother at the time of birth. This definition could help to identify cases where the person was born abroad in exceptional circumstances.

For the purpose of this question, current national boundaries should be considered, rather than any applying at the time of the respondent's birth.

This should be provided according to the coding given in Annex IV. If possible the exact country should be indicated; where this is not possible, one of the general groupings in bold print should be used. European States must be coded individually.

Col 23: (PROXY) Nature of participation in the survey

Code 1 includes all cases where the person is responding directly, even with the assistance of a third person (e.g. interpreter).

Labour status

Col 24: (WSTATOR) Labour status during the reference week

Information provided here determines whether a person is considered as being in employment or not, following the guidelines of International Labour Organisation (ILO). Persons in employment are those coded 1 or 2.

Code 1: Did any work for pay or profit during the reference week

"Work" means any work for pay or profit during the reference week, even for as little as one hour. Pay includes cash payments or "payment in kind" (payment in goods or services rather than money), whether payment was received in the week the work was done or not. Also counted as working is anyone who receives wages for on-the-job training which involves the production of goods or services. Self-employed persons with a business, farm or professional practice are also considered to be working if one of the following applies:

- (i) A person works in his own business, professional practice or farm for the purpose of earning a profit, even if the enterprise is failing to make a profit.
- (ii) A person spends time on the operation of a business, professional practice or farm even if no sales were made, no professional services were rendered, or

nothing was actually produced (for example, a farmer who engages in farm maintenance activities; an architect who spends time waiting for clients in his/her office; a fisherman who repairs his boat or nets for future operations; a person who attends a convention or seminar).

- (iii) A person considered as self-employed is in the process of setting up a business, farm or professional practice; this includes the buying or installing of equipment, and ordering of supplies in preparation for opening a new business.

Unpaid family workers: Persons working in a family business or on a family farm without pay should be living in the same household as the owner of the business or farm, or in a slightly broader interpretation, in a house located on the same plot of land and with common household interests. Such people frequently receive remuneration in the form of fringe benefits and payments in kind. However, this applies *only* when the business is owned or operated by the individual themselves or by a relative. Thus, unpaid voluntary work done for charity should *not* be included.

The category includes:

- A son or daughter living inside the household and working in the parents' business or on the parents' farm without pay.
- A wife who assists her husband in his business, e.g. a haulage contractor, without receiving any formal pay.

Persons who work on their own agriculture farm should be considered as employed (code 1 if he worked during the reference week, otherwise code 2) only in case at least part of their production is sold, whichever the total amount of the products. What is considered here is the usual destination of the production, and not whether a sale took place in the reference week. A person who worked in agricultural production during the reference week, did not sale anything because harvesting will take place in few weeks or months, should be consider as having worked for pay or profit in the reference week (code 1). Persons who work on their own small agriculture farm, who do not sell their products, and produce only for their own consumption should not be considered as employed (code 5).

Persons who are obliged to perform some work to keep receiving unemployment benefits
In some countries, unemployed (under special circumstances) have to perform some work to keep receiving the unemployment allowances. If they have performed some work during the reference week, they should be coded 1.

Persons who are building a house

If a person is building a house in order to earn a future financial profit (renting or selling it), he should be considered as employed (code 1 if he worked during the reference week, otherwise code 2). Building a house for only a family use is not enough to be considered as employed.

Conscripts performing some work for pay or profit during the reference week should always be coded 4.

Persons in paid employment who were on training during the whole reference week should be coded 1 if one of the three following statements is true:

- the participation of the employee is required by the employer
- the training takes place inside normal working hours
- the training is directly connected to the current job

Code 2: Was not working but had a job or business from which he/she was absent during the reference week

In general, the notion of temporary absence from work refers to situations in which a period of work is interrupted by a period of absence. This implies that persons are generally to be considered as having been temporarily absent from work and therefore employed, if they had already worked at their current activity and were expected to return to their work after the period of absence. Persons without work who had made arrangements to take up paid employment or to engage in some self-employment activity at a date subsequent to the reference period, but who had not yet started work, are not to be considered as temporarily absent from work.

For employees

A job exists if there is a definite and pre-scheduled arrangement between an employer and employee for regular work (that is, every week or every month), whether the work is full-time or part-time. The number of hours of work done each week or each month may vary considerably, but as long as some work is done on a regular and scheduled basis, a job is considered to exist.

In the case of employees, a person absent from work should be considered as employed if there is a formal attachment to the job, for example if at least one of the following criteria is fulfilled:

- the continued receipt of wage or salary, and an assurance of a return to work (or an agreement as to the date of return) following the end of the contingency..
- the elapsed duration of absence from the job which, wherever relevant, may be that duration for which workers can receive compensation benefits without obligation to accept other jobs.

Seasonal workers

During the off-season, seasonal workers cannot be considered as having a formal attachment to their high-season job if they have an assurance to come back to work with the same employer at the beginning of the next season and the employer continues to pay at least 50% of their wage or salary during the off-season. In this case they have to be coded 2 during the off-season. In other cases, they have to be considered as not employed (code 5).

Maternity and paternity leave

Maternity leave is first given to the mother (but may include the leave of the father in the case of a transfer of the entitlements) and corresponds to the compulsory or statutory period of the leave stipulated by national legislation to ensure that mothers before and after childbirth have sufficient rest, or for a period to be specified according to national circumstances.

People on maternity leave should always be coded 2 in Col 24. Paternity leave is also included under this code.

For unpaid family workers

The unpaid family worker can be said to have a job but not be at work if there is a definite commitment by the employer (a related household member) to accept his/her return to work and the total absence do not exceed a period of 3 months. In this point

EuroStat diverges from the ILO recommendation. If the period of absence exceeds 3 months they should be coded 5 in Col 24.

For self-employed persons

If self-employed persons are classified as being absent from work, then they are regarded as in employment only if they can be said to have a business, farm or professional practice. This is the case if one or more of the following conditions are met:

- (i) Machinery or equipment of significant value, in which the person has invested money, is used by him or his employees in conducting his business.
- (ii) An office, store, farm or other place of business is maintained.
- (iii) There has been some advertisement of the business or profession by listing the business in the telephone book, displaying a sign, distributing cards or leaflets, etc.

If none of these conditions is met, then the person is regarded as not being in employment and therefore should be coded 5 in Col 24.

Code 3: Was not working because on lay-off.

A person on lay-off is one whose written or unwritten contract of employment, or activity, has been suspended by the employer for a specified or unspecified period at the end of which the person concerned has a recognised right or recognised expectation to recover employment with that employer.

Lay-offs are classified as employed if they have an assurance of return to work within a period of 3 months or receive $\geq 50\%$ of their wage or salary from their employer.

Lay-offs are classified as unemployed if they receive less than 50% of their wage or salary from their employer, don't have assurance of return to work or have an agreed date but this date falls after a period of 3 months and if they are "available to start work in 2 weeks" and have "actively searched for a job in the last 4 weeks".

Otherwise they are considered as inactive.

In case respondents can't say if they receive more or less than 50% of the salary and if they don't have an assurance of return to work within a period of 3 months the code 3 should be used.

Persons without employment during the reference week but who have found a job to start in the future should always be coded 5 in this column.

Col 25/26: (NOWKREAS) Reason for not having worked at all although having a job

Code only one reason. If the respondent gives more than one reason, code the one that explains the greatest number of hours away from work.

Code 01: This includes difficulties such as plant breakdown or materials shortage; see also note below on Code 02. A person in slack work for technical or economic reasons should have a formal attachment to his/her job.

Code 02: This code only applies to persons who were directly involved in a labour dispute. Other persons who did not work because production in the establishment was

impeded by a labour dispute outside the establishment (thus causing a shortage in material supplies for example) are coded 01.

Code 03: It refers to all kind of school education or training, inside or outside the workplace.

Code 05: Maternity leave corresponds to the compulsory or statutory period of the leave stipulated by national legislation to ensure that mothers before and after childbirth have sufficient rest, or for a period to be specified according to national circumstances. Paternity leave is also included under this code.

Code 06: Parental leave can be taken either by the mother or the father and is the interruption of work to bring up a child of young age. This code is used only for those persons on statutory parental leave (legal or contractual). Any other leave taken for reasons of child-bearing or rearing is coded 09.

Code 08: This code includes all absences that are related to working time flexibility. Examples are time off as a compensation of overtime, as a compensation of credit hours within a system of working time banking or within the framework of an annualised hours contract (This category is a parallel to code 07 in Column 69/70). Cases of people who work full-time one week, and not at all the following week are included here.

Employment characteristics of main job

Col 27: (STAPRO) Professional status

The professional status requested here refers to the main job. For the purposes of Col. 27 to 77, multiple job holders decide for themselves which job is to be considered as the first job. In doubtful cases, the first job should be the one with the greatest number of hours usually worked. Persons having changed jobs during the reference week should regard the job held at the end of the reference week as their main job.

Code 1: Self-employed with employees

If people working in the business, professional practice or farm, are not paid then he/she should be considered as self employed without staff.

Code 2: Self-employed without employees

People who engage members of his/her own family or apprentices without payment should be classified in code 2. In this category one can find farmers working alone or using the assistance of members of family.

A person who looks after one or more children that are not his/her own on a private basis and receiving a payment for this service should be considered as self-employed, except when he/she works for a single employer and receives employment rights from that employer (e.g. holiday pay) he/she should be classified as an employee (code 3).

A freelancer should in general be classified as self-employed. However in situations where freelancer works for a single employer and receives employment rights from that employer (e.g. holiday pay) he should be classified as an employee (code 3).

A person who gives private lessons should be considered as self-employed if he/she is directly paid by his/her students.

Members of producers' co-operatives should be considered as self-employed. In the case co-operative hired workers and these workers have an employment contract that gives them a basic remuneration (which is not directly dependent upon the revenue of the co-operative), these workers are identified as employees of the co-operative. Even if the co-operative has employees (e.g. an accountant) the members of the co-operative should be considered as "self-employed without employees" because the co-operative as an institution (and not any of its members) is the employer.

Code 3: Employee

An employee is usually working for an outside employer, but a son or daughter, for example, who is working in a parent's firm and receives a regular monetary wage is classified here as an employee.

A person looking after children in his/her own home is classified as an employee if he/she is paid to do this by the local authority (or any other public administration) and if he/she doesn't take any decision affecting the enterprise (e.g. schedules or number of children) but should be classified as self-employed if he/she does it privately (code 2).

Apprentices or trainees receiving remuneration should be considered as employees.

Priests (of any kind of religion) are considered employees

Code 4: Family worker

Persons working in a family business or on a family farm without pay should be living in the same household as the owner of the business or farm, or in a slightly broader interpretation, in a house located on the same plot of land and with common household interests. Such people frequently receive remuneration in the form of fringe benefits and payments in kind. However, this applies *only* when the business is owned or operated by the individual themselves or by a relative. Thus, unpaid voluntary work done for charity should *not* be included.

The category includes:

- A son or daughter living inside the household and working in the parents' business or on the parents' farm without pay.
- A wife who assists her husband in his business, e.g. a haulage contractor, without receiving any formal pay.

The category does not include:

- A relative living elsewhere but coming to help with the business, e.g. during the harvesting season, without pay in money or kind should not be included. If the relative receives any remuneration (including benefits in kind) the professional status should be coded as 3 (Employee).

Col 28: (SIGNISAL) Continuous receipt of the wage or salary

The total duration of the absence should be calculated. If the person does not know the total duration, it should be calculated as the elapsed time between the moment the person last worked and the end of the reference week.

The salary to be considered in this variable is the current salary from the main job and net salary should be preferred unless gross salary is easier to collect. Salary can be paid by the employer or by the social security (or both). It includes any compensation

of wages (e.g. parental leave allowance linked to the job) but excludes any other benefit which the person would receive even without a job (e.g. family allowances).

The main target groups for this variable are the persons in long term absences:

- the parental leave
- the paid or unpaid leave initiated by the employer or the administration
- the educational or training leave
- other kinds of career breaks

Col 29/31: (NACE3D) Economic activity of the local unit

The local unit is an enterprise or part thereof (e.g. a workshop, factory, warehouse, office, mine or depot) situated in a geographically identified place. At or from this place economic activity is carried out for which one or more persons work (even if only part-time) for one and the same enterprise.

The NACE codes in Annex II are derived from the Statistical Classification of Economic Activities.

If a person works in more than one place (transport, construction, maintenance, surveillance, peripatetic work...) or at home, or in the consumer's place (e.g. surveillance, security, cleaning ...), the local unit is taken to be the place from where instructions emanate or from where the work is organised.

The economic activity of the local unit for persons with a contract with a temporary employment agency should be coded as the activity of the local unit where they actually work and not in the industry of the agency which employs them.

For those countries that are not able to provide information at a 3 digit level the third digit should be coded '0'.

Col 32/35: (ISCO4D) Occupation

This should be coded according to the classification provided in Annex III.

For those countries that are not able to provide information at a 4 digit level the fourth digit should be coded '0'.

Col 36: (SUPERVISOR) Supervisory responsibilities

A person is considered to have supervisory responsibilities when they supervise the work of at least one (other) person. He/she takes charge of the work of other employees, directs their work and sees that is satisfactorily carried out.

Supervisory responsibility includes formal responsibility for directing other employees (other than apprentices), whom they supervise directly, sometimes doing some of the work they supervise and excludes quality control (check output of services but not the work produced by other persons) and consultancy.

It should be considered the usual situation and not the situation only during the reference week.

Sometimes job titles can be misleading. For example, a 'playground supervisor' supervises children not employees and so should be coded 2. Similarly, a 'store manager' may be a storekeeper and not a supervisor of employees.

In some cases the person is cumulating supervising responsibilities with other functions; even if the supervising responsibilities only constitute a part of their job, they should be coded 1.

Persons having supervisory responsibilities only because they are temporarily replacing an absent superior should not be considered as having supervisory responsibilities. The definition of temporarily here is left to the respondent.

Members of groups with Collective responsibility (groups where there is a rotating leadership in a continuous way taking charge of the work of other employees, directing their work and seeing that is satisfactorily carried out) should be considered as having supervisory responsibilities.

Col 37/38: (SIZEFIRM) Number of persons working at the local unit

The number of persons working at the local unit is defined as the total number of persons who work inside the unit (inclusive of working proprietors, partners working regularly in the unit and unpaid family workers), as well as persons who work outside the unit who belong to it and are paid by it (e.g. sales representatives, delivery personnel, repair and maintenance teams). It includes persons absent for a short period (e.g. sick leave, paid leave or special leave), and also those on strike, but not those absent for an infinite period. It also includes part-time workers who are regarded as such under the laws of the country concerned and who are on the payroll, as well as seasonal workers, apprentices and home workers on the payroll (definition of the regulation on Structural Business Surveys).

For the term "local unit", see notes to Col 29/31 (*Economic activity of the local unit*). The codes provided permit either an exact number to be indicated for units with 10 people or less (codes 01-10), broad classes for units with more than 10 (codes 11-13), or simply an indication of whether it is greater or less than ten (codes 14 and 15).

This variable should reflect the current situation but including people temporarily absent. The interviewed person should be included as well.

The number of persons employed should exclude manpower supplied to the unit by other enterprises, persons carrying out repair and maintenance work in the enquiry unit on behalf of other enterprises, as well as those on compulsory military service.

For pragmatic reasons, persons working for a temporary employment agency should provide the numbers of persons working in the local unit where they perform their work.

Codes 14 and 15 should only be used in case 1-13 cannot be coded.

Col 39/40: (COUNTRYW) Country of place of work

This should be provided according to the coding shown in Annex IV. If possible the exact country should be indicated; where this is not possible, one of the general groupings in bold print should be used. Member States must be coded individually.

If you have varied places of work, the country of work is the one where the local unit is settled.

Person working in embassies should be coded as working in the host country.

Col 41/42: (REGIONW) Region of place of work

This should be provided according to the coding system in Annex I, which is based upon the Classification of Territorial Units (NUTS).

Col 43/46 & Col 47/48: (YSTARTWK & MSTARTWK) Year/Month in which person started working for this employer or as self-employed in their current occupation

Renewed contracts

If a respondent has a contract that is renewed, for example yearly, without interruption, the year and the month should be those of the first contract. If there is a legal obligation that an interruption for a certain period of time is necessary before the renewal, this should nonetheless be considered as renewal (and not as a separate spell).

Separate spells of employment

For employees, we are interested in continuous employment with their current employer. Any previous separate spells of work with their current employer with an interruption of the contract should be ignored. The year which the person started the most recent spell should be coded (e.g. seasonal workers).

Company changed ownership

If the respondent's company or firm changed ownership, but his or her conditions of employment did not change, it should be treated as one continuous period of employment. However, if the respondent was made redundant and then re-employed by the new owners, enter the date on which they were re-employed.

Employment agencies

People employed by employment agencies should answer when they started working continuously for this employment agency (despite the fact that in the case of temporary workers the branch of economic activity and the staff category should be based on the current local unit).

Secondment

An employee who has been seconded to another organisation (public or private) should be treated as having no break in employment, IF they have signed a contract that is exactly the same as their existing contract.

Self-employment

For the self-employed make it clear that we are interested in the length of time the respondent has been continuously self employed in the occupation of his current main job.

Col 49: (WAYJFOUN) Involvement of the public employment office at any moment in finding the present job

The involvement of the public employment office should be effective, i.e. having contributed to the finding of the current job. It should be a role of putting in contact the employer and the employee by informing one of the existence of the other. "Putting in contact" should be interpreted broadly, and could simply involve the respondent seeing a job vacancy on the website of the employment office.

Jobs found through the home page of the public employment office have also to be coded as 1.

When the action of public employment office is only to send the person to training courses or any other activities that improve the skills of job searchers and which had allowed the person to take this job, without putting the person in contact with his current employer, then the code 0 applies.

Col 50: (FTPT) Full-time/Part-time distinction

This variable refers to the main job. A part-time worker is “an employed person whose normal hours of work are less than those of comparable full-time workers” (International Labour Conference, 81st session, 1994).

The distinction between full-time and part-time work should be made on the basis of a spontaneous answer given by the respondent. It is impossible to establish a more exact distinction between part-time and full-time work, due to variations in working hours between Member States and also between branches of industry.

Col 51: (FTPTREAS) Reasons for part-time work

The current main reason for working part-time should be coded.

Code 3: Care includes all care responsibilities:

- For own children or spouse children living inside or outside the household
- For other children (up to 14) living inside or outside the household
- For adult ill/elderly/incapacitated/disabled relatives/friends (aged 15 or more)

But excludes:

- Care as a job (it means that care done in a professional capacity is excluded).
- Care as a volunteer work (e.g. for a charity organisation)

In both cases, they should be coded as 6.

Col 52: (TEMP) Permanency of the job

Employees with a limited duration job/contract (code 2) are employees whose main job will terminate either after a period fixed in advance, or after a period not known in advance, but nevertheless defined by objective criteria, such as the completion of an assignment or the period of absence of an employee temporarily replaced.

Code 2 includes:

- Persons with a seasonal job
- persons engaged by a temporary employment agency or business and hired out to a third party for the carrying out of a "work mission" (unless there is a work contract of unlimited duration with the employment agency or business)
- Persons with specific training contracts.

What is involved is the actual employment being time-limited under an agreement - not that he/she has, for example, considered stopping work in order to travel or attend College.

Respondents who have a contract to do their job, which is expected to be renewed, for example, once a year, should be coded according to whether or not the respondents themselves consider their job to be of an unlimited duration.

A person having a contract for a probationary period should be coded 2 (see definition of probationary period in the explanatory note of col 53 (*Reasons for having a temporary job/work contract of limited duration*)).

In case of secondment from a permanent job, the person should be considered as having a contract of unlimited duration, if the person has an assurance to go back to his previous job.

Col 53: (TEMPREAS) Reasons for having a temporary job/work contract of limited duration
The probationary period is part of a selection process during which an employee new to a job is required to demonstrate fitness for the job by actual performance of the job's duties.

In the case where more than one category applies temporary work in relationship with a period of training or trial period (Col. 53= 1 or 4) are priority reasons for a temporary job.

The current reason of having a temporary job should be coded, even if it differs from the starting reason.

Col 54: (TEMPDUR) Total duration of temporary job or work contract of limited duration
This refers to the total of the time already elapsed plus the time remaining until the end of the current contract.

Code 2 should be interpreted as 1 month to less than 4 months, code 3 as 4 to less than 7 months and so on.

Persons who have a contract to perform a task should be prompted for a best estimate for how long it would take.

Respondents who have a contract to do their job, which is renewed, for example, once a year, should be coded referring to the current contract.

Col 55: (TEMPAGCY) Contract with a temporary employment agency
A temporary employment agency is a firm which places workers with whom it has entered contracts of employment at the temporary disposal of user firms.

Work for a temporary employment agency involves a triangular employment relationship between an employee who is paid by the employment agency but performs work for and under the supervision of a user enterprise.

Staff leasing is excluded here; staff leasing applies in the case when the type of expert knowledge or experience needed by the user enterprise is matched by the economic activity of the service provider. The service provider has not a general intermediary function on the labour market.

Staff working directly for the temporary employment agency (administrative tasks), i.e. not employed to perform any work for and under the supervision of a user enterprise, should be coded 0.

Persons employed by an agency to perform work for and under the supervision of a user enterprise, but not performing any work during the reference week for and under the supervision of a user enterprise and who are asked to perform administrative or

other tasks for the agency should anyway be coded as working for a temporary employment agency because this situation do not correspond to their usual situation. If a country has this information from other sources this variable can be imputed and the information does not have to be collected by interview.

The "Economic activity of the local unit" (NACE3D) for persons with a contract with a temporary employment agency should be coded as the activity of the enterprise where they actually work and not in the industry of the agency which employs them.

Atypical work

Col 56: (SHIFTWK) Shift work

"Shift work" means any method of organising work in shifts whereby workers succeed each other at the same work stations according to a certain pattern, including a rotating pattern, and which may be continuous or discontinuous, entailing the need for workers to work at different times over a given period of days or weeks (definition of the directive 2003/88/EC).

Shift work usually involves work on unsocial hours in the early morning, at night or in the weekend and the weekly rest days do not always coincide with the normal rest days.

Shift work should imply changes in the working schedule. Persons having fixed assignment to a given shift should not be considered as shift-workers, even if their working schedules are defined in their establishment in terms of shift work.

Col 57: (EVENWK) Evening work

The definitions of evening and night vary considerably so that it is not easy to establish a strictly common basis for all Member States. Generally speaking, however, "evening work" must be considered to be work done after the usual hours of working time in this Member State, but before the usual sleeping hours. This implies the possibility of sleeping at normal times (whereas "night work" implies an abnormal sleeping pattern).

Code 1: "Usually" in this context should be interpreted to mean:

- for self-employed, working during the evenings at least half of the days worked in a reference period of four weeks preceding the end of the reference week.
- for employees, having a formal working time arrangement to work in the evenings and working during the evenings at least half of the days worked in a reference period of four weeks preceding the end of the reference week.

Code 2: "Sometimes" in this context should be interpreted to mean:

- for self-employed, working during the evenings less than half of the days worked, but a least in one occasion in a reference period of four weeks preceding the end of the reference week.
- for employees, having a formal working time arrangement to work in the evenings and working during the evenings less than half of the days worked in a reference period of four weeks preceding the end of the reference week.

Code 3: "Never" in this context should be interpreted to mean:

- for self-employed, working during the evenings on no occasion in a reference period of four weeks preceding the end of reference week.
- for employees, having no formal working arrangement to work in the evening.

Col 58: (NIGHTWK) Night work

Bearing in mind the definitional problems discussed under Col 57 (Evening work), "night work" must be generally considered to be work done during the usual sleeping hours. This implies an abnormal sleeping pattern (whereas "evening work" implies the possibility of sleeping at normal times). As foreseen by directive 2003/88/EC, the definition of usual sleeping hours can vary by country but, in any case, it should include hours between midnight and 5 a.m.

Code 1: "Usually" in this context should be interpreted to mean:

- for self-employed, working during the nights at least half of the days worked in a reference period of four weeks preceding the end of the reference week.
- for employees, having a formal working time arrangement to work in the nights and working during the nights at least half of the days worked in a reference period of four weeks preceding the end of the reference week.

Code 2: "Sometimes" in this context should be interpreted to mean:

- for self-employed, working during the nights less than half of the days worked, but at least in one occasion in a reference period of four weeks preceding the end of the reference week.
- for employees, having a formal working time arrangement to work in the nights and working during the nights less than half of the days worked in a reference period of four weeks preceding the end of the reference week.

Code 3: "Never" in this context should be interpreted to mean:

- for self-employed, working during the nights on no occasion in a reference period of four weeks preceding the end of reference week.
- for employees, having no formal working arrangement to work in the nights.

Col 59: (SATWK) Saturday work

Code 1: "Usually" in this context should be interpreted to mean:

- for self-employed, working on Saturdays at least half of the days worked in a reference period of four weeks preceding the end of the reference week.
- for employees, having a formal working time arrangement to work on Saturdays and working during on Saturdays at least half of the days worked in a reference period of four weeks preceding the end of the reference week.

Code 2: "Sometimes" in this context should be interpreted to mean:

- for self-employed, working on Saturdays less than half of the days worked, but at least in one occasion in a reference period of four weeks preceding the end of the reference week.
- for employees, having a formal working time arrangement to work on Saturdays and working during on Saturdays less than half of the days worked in a reference period of four weeks preceding the end of the reference week.

Code 3: "Never" in this context should be interpreted to mean:

- for self-employed, working on Saturdays on no occasion in a reference period of four weeks preceding the end of reference week.
- for employees, having no formal working arrangement to work on Saturdays.

Col 60: (SUNWK) Sunday work

Code 1: "Usually" in this context should be interpreted to mean:

- for self-employed, working on Sundays at least half of the days worked in a reference period of four weeks preceding the end of the reference week.
- for employees, having a formal working time arrangement to work on Sundays and working during on Sundays at least half of the days worked in a reference period of four weeks preceding the end of the reference week.

Code 2: "Sometimes" in this context should be interpreted to mean:

- for self-employed, working on Sundays less than half of the days worked, but at least in one occasion in a reference period of four weeks preceding the end of the reference week.
- for employees, having a formal working time arrangement to work on Sundays and working during on Sundays less than half of the days worked in a reference period of four weeks preceding the end of the reference week.

Code 3: "Never" in this context should be interpreted to mean:

- for self-employed, working on Sundays on no occasion in a reference period of four weeks preceding the end of reference week.
- for employees, having no formal working arrangement to work on Sundays.

Hours worked

Col 61/62: (HWUSUAL) Number of hours per week usually worked in the main job

Usual hours worked are the modal value of the actual hours worked per week (see definition of Col 63/64) over a long reference period, excluding weeks when an absence from work occurs (e.g. holidays, leaves, strikes ...). For employees covered by an employment contract, it should include contractual hours of work plus overtime that the employee is expected to work regularly according to his or her contract.

The "long reference period" mentioned here is at least the last four weeks and at most the three last months without counting any absence from work. When such a long reference period cannot be identified (because the working hours vary too much, or the person has just started a new job), a proxy can be accepted:

- the contractual hours of work in the reference week, for those who have an employment contract, plus regular overtime if the worker is expected to work overtime
- an average of the actual hours worked in the last four weeks, plus the hours of absence of work in the last four weeks.

The implementation rules mentioned for Col 63/64 about main meal breaks, on-call time, travelling time, training time, working at home, teachers and farmers also apply for HWUSUAL.

People absent for a long period:

For people in employment who last worked before the long reference period of at least four weeks, the usual hours worked should refer to the situation immediately before the start of the extended absence from work. Thus the usual hours of work of persons on maternity leave refer to the usual hours as they would have been identified had the person been asked in the week before starting the maternity leave.

For people who have different working time arrangement depending on seasons, the usual hours worked should refer to the current season.

Col 63/64: (HWACTUAL) Number of hours actually worked during the reference week (main job)

Actual hours worked in the reference week are the hours the person spends in work activities during the reference week.

Work activities should include:

- production activities: activities when directly engaged in the production of good or services as defined in the European System of Accounts.
- ancillary activities: activities not directly intended for the production of goods or services but which are necessary to enable such production (such as travel between places of work, personnel management)
- short pauses: interruptions in the production or ancillary activities that are the necessary consequence of the organisation of the work activities or the use of labour, such as short rest periods (incl. coffee breaks)
- education and training which is necessary for successfully carrying out of either the production or ancillary activities.

Actual hours worked should exclude:

- travel time between home and the place of work
- the main meal breaks
- education and training hours which are not directly necessary for carrying out the production or ancillary activities
- absences from work within the working period for personal reasons (such as visits to the doctor).

Actual hours worked should include time spent at the place of work such as preparing the site, repair and maintenance work, the preparation and cleaning of the tools, and the making-out of receipts, invoices, records of the length of time worked and other reports.

Working hours not paid by the employer (including unpaid overtime)

For employees, the hours have not to be explicitly required by the employer, but it has to be hours spent in activities related to the job that the employee is paid for. The hours spent in such activities but not recognised by the employer should be included in actual hours worked.

On-call time

The directive 2003/88/EC defines on-call time as the “period during which the worker has the obligation to be available at the workplace in order to intervene, at the employer's request, to carry out his activity or duties”⁵.

⁵ Remark: There are two definitions of “on-call” The working time directive essentially refers to what is called “stand-by” in the US. In the 2001 and 2004 ahm on working time arrangements “on-call” was defined differently as a contractual arrangement when the worker only works when called without the obligation either to perform the duty or for the

The workplace is defined as “the place or places where the worker normally carries out his activities or duties and which is determined in accordance with the terms laid down in the relationship or employment contract applicable to the worker”.

The inactive part of on-call time is the “period during which the worker is on-call, but not required by his employer to carry out his activity or duties”.

The active part of on-call time should be obviously included in the working hours.

The idle part at the workplace (e.g. sleeping hours in a hospital for a doctor) should be included in the working hours, as the worker must be in a state of readiness.

The inactivity outside the normal workplace is not work activity unless the burden or the restrictions placed on the worker are too high, such requirement to wear uniforms, to stay in a special accommodations outside the workers home.

Training time inside/outside the workplace

For employees, training time should be included if one of the following statements is true:

- the participation of the employee is required by the employer
- the training takes place inside normal working hours
- the training is directly connected to the current job

Treatment of travelling time for business trips

For purely business trips, related to the current job, travelling time has to be considered as time spent in ancillary activities, and then to be included in actual hours worked.

Working at home

The time spent at home in working activities directly related to the current job has to be taken into account in the actual working hours (and also in the usual, if they occur regularly).

Teachers

Usually the teachers' employment contract refers to weekly hours spent in the classroom. However, all actual hours worked directly related to teaching have to be considered. It particularly includes teaching in or out the class, preparation and planning the course, marking, attending meetings and conferences related to teaching. Supervision of school trips where attendance is required should be included (sleeping hours during school trips should be excluded).

Farmers

Hours spent in running the farm, preparing the production for selling, supervising employees, as well as hours spent in commercial and administrative tasks linked to the farm should be counted here.

Hours spent in production only designated to own consumption, and hours spent in the farm without doing anything connected to the agricultural business should be excluded.

employer to guarantee the work. In UK English this would be called zero-hours arrangement (example: babysitters).

Col 65/66: (HWOVERP) Paid overtime in the reference week in the main job

Overtime hours are the number of hours actually worked by an employee in excess of his or her contractual hours of work.

Contractual hours of work are the hours the employee is expected to work in the reference week as predetermined (by order of preference) by convention at the enterprise level, by collective agreement or by the legislation.

Paid overtime hours are the number of hours actually worked by an employee in excess of his or her contractual or normal daily or weekly hours of work for which the employee is entitled to compensation, in pay, kind or compensatory leave.

When the person does not know his contractual hours the benchmark should be the general number of hours foreseen by the legislation for full-time workers.

Contractual hours used as benchmark to calculate the overtime hours (contractual or normal hours) should exclude the hours of absence from work during the reference week (free days, leaves, holidays, ...).

Flexitime arrangement is an agreement between the employer and the employee that requires an employee to be at work during a specified core period, but lets them otherwise arrange their hours to suit themselves. During a specific period (a fortnight, a month, a year), the employer and the employee agree on a given number of hours, but the pattern of work can vary from week to week. In this case, only hours outside the flexitime arrangement should be overtime hours. If these working hours are paid as overtime hours, then they should be included here.

Working time banking: extra working hours (hours in addition to contractual hours of work) performed in the reference week, and recuperated later (additional leave or period of rest after the reference week) should be included in overtime hours in the reference week. As there are entitled to compensatory leave, then they should be considered as paid overtime. Daily overtime compensated by time off during the reference week should be excluded here.

For teachers, paid overtime is time spent in paid courses in excess of their regular contract.

Col 67/68: (HWOVERPU) Unpaid overtime in the reference week in the main job

Unpaid overtime hours are the number of hours actually worked by an employee in excess of his or her contractual or normal daily or weekly hours of work for which the employee is not entitled to compensation, in pay, kind or compensatory leave.

For employees, the hours have not to be explicitly required by the employer, but it has to be hours spent in activities related to the job that the employee is paid for. The hours spent in such activities but not recognised by the employer should be included in unpaid overtime.

Flexitime arrangement is an agreement between the employer and the employee that requires an employee to be at work during a specified core period, but lets them otherwise arrange their hours to suit themselves. During a specific period (a fortnight, a month, a year), the employer and the employee agree on a given number of hours, but the pattern of work can vary from week to week. In this case, only hours outside the flexitime arrangement should be overtime hours. If these working hours are not paid as overtime hours, then they should be included here.

Working time banking: extra working hours (hours in addition to contractual hours of work) performed in the reference week, and recuperated later (additional leave or period of rest after the reference week) should be considered as paid overtime and excluded for this variable. Daily overtime compensated by time off during the reference week should also be excluded here.

For teachers, unpaid overtime are hours spent in the preparation of the courses done in addition to their regular contract.

Col 69/70: (HOURREAS) Main reasons for hours actually worked during the reference week being different from the person's usual hours

This question should also be asked of those persons who did not state their usual hours (Col 61/62 = 00). They may know if they have worked considerably more or less than usual even if they cannot give a number for their usual hours.

In a case where more than one reason applies, the reason to be coded is that which explains the greatest number of hours. In the case where the same number of hours is justified by different reasons, the following rule should be applied: if one of these reasons is "overtime" then code 16 should be coded, otherwise the lowest code should be coded.

Code 01: Applies in case of flexitime arrangement.

Code 04: This includes difficulties such as plant breakdown or materials shortage; see also note below on Code 05.

Code 05: This code only applies to persons who were directly involved in a labour dispute. Other persons who did not work because production in the establishment was impeded by a labour dispute (thus causing a shortage in material supplies, for example) are coded 04.

Code 09: Maternity leave is first given to the mother (but may include the leave of the father in the case of a transfer of the entitlements) and corresponds to the compulsory or statutory period of the leave stipulated by national legislation to ensure that mothers before and after childbirth have sufficient rest, or for a period to be specified according to national circumstances. Paternity leave should be included here.

Code 09: Parental leave can be taken either by the mother or the father and is the interruption of work in the case of childbirth or to bring up a child of young age. It should correspond to the statutory period provided by the national legislation. This code is used only for those persons on statutory parental leave (legal or contractual). Any other leave taken for reasons of child-bearing or rearing is coded 10: "special leave for personal or family reasons".

Code 16: Overtime includes paid and unpaid overtime as defined for variables HWOVERP (Col 65/66) and HWOVERPU (Col 67/68).

Col 71: (WISHMORE) Wish to work more hours than the current numbers of hours

Persons in time-related underemployment comprise all persons in employment, as defined in current international guidelines regarding employment statistics, who satisfy the following three criteria during the reference period used to define employment:

- a) "willing to work additional hours", i.e. wanted another job (or jobs) in addition to their current job (or jobs) to increase their total hours of work; to replace any of their current jobs with another job (or jobs) with increased hours of work; to increase the hours of work in any of their current jobs; or a combination of the above. In order to show how "willingness to work additional hours" is expressed in terms of action which is meaningful under national circumstances, those who have actively sought to work additional hours should be distinguished from those who have not. Actively seeking to work additional hours is to be defined according to the criteria used in the definition of job search used for the measurement of the economically active population, also taking into account activities needed to increase the hours of work in the current job;
- b) "available to work additional hours", i.e. are ready, within a specified subsequent period, to work additional hours, given opportunities for additional work. The subsequent period to be specified when determining workers' availability to work additional hours should be chosen in light of national circumstances and comprise the period generally required for workers to leave one job in order to start another;
- c) "worked less than a threshold relating to working time", i.e. persons whose "hours actually worked" in all jobs during the reference period, as defined in current international guidelines regarding working time statistics, were below a threshold, to be chosen according to national circumstances. This threshold may be determined by e.g. the boundary between full-time and part-time employment, median values, averages, or norms for hours of work as specified in relevant legislation, collective agreements, agreements on working time arrangements or labour practices in countries.

The question should refer to the usual situation in all the jobs. In the same resolution as the definition mentioned above, it is stated that: "To provide analytical flexibility for policy formulation and evaluation, as well as for international comparability, countries should endeavour to identify all workers who during the reference period were willing and available to work additional hours, regardless of the hours they actually worked during the reference period".

Col 72: (WAYMORE) Way that a person can work more

Code 4: This code applies to those persons who would like to work a greater number of hours with none of the restrictions set out in codes 1 to 3.

Col 73/74: (HWWISH) Number of hours that the person would like to work in total

This variable should include the total number of working hours the person would like to work.

Col 75: (HOMEWK) Working at home

This concept applies also to self-employed people, for example in artistic or professional activities, who work wholly or partly at home, often in a part of their living accommodation set aside for the purpose.

However, if the place of work comprises a separate unit (for example, a doctor's surgery or tax consultant's practice) which is adjacent to the person's home but contains a separate entrance, then work performed there should not be considered to

be done "at home". Similarly, a farmer is not to be regarded as working "at home" when he is occupied in fields or buildings adjacent to his house.

In the case of employees, "working at home" should be interpreted strictly in terms of formal working arrangements, where it is mutually understood by the employee and the employer that a certain part of the work is to be done at home. Such an arrangement may be explicitly included in the terms of employment, or may be recognised in other ways (for example, if the employee explicitly notifies the employer of this work by completing a timesheet, or by requesting additional payment or other form of compensation). This arrangement is also recognised if an employee is equipped with a computer in his home in order to perform his work.

Other typical examples of "working at home" include travelling salesmen who prepare at home for appointments with clients which are then held at the clients' offices or homes, or persons who do typing or knitting work which on completion is sent to a central location.

"Working at home" does not cover cases where employees carry out tasks at home (because of personal interest or pressure of time), which under their working arrangements might equally have been performed at their place of work.

Code 1: "Usually" in this context should be interpreted to mean that during a reference period of four weeks preceding the interview, the person did work at home within the framework of an agreement as described above, and the number of occasions on which he did so amounted to half or more of the days worked in this period.

Code 2: "Sometimes" in this context should be interpreted to mean that during a reference period of four weeks preceding the interview, the person did work at home within the framework of an agreement as described above, but the number of occasions on which he did so amounted to less than half of the days worked in this period.

Code 3: "Never" in this context should be interpreted to mean that during a reference period of four weeks preceding the interview, the person did not on any occasion work at home within the framework of an agreement as described above.

Col 76: (LOOKOJ) Looking for another job

The reference period of the question should be the four weeks preceding the end of the reference week.

Should be considered as searching for employment (code 1). It includes people who are looking for a different job at the current employer, as well as people who have applied for a permanent position on the same job that they are now performing.

Self-employed people may interpret 'looking for additional job' as trying to increase their present business. Looking for additional clients is not enough to be coded 1 here. Self-employed people should be coded 1 for this question if they were looking for a job as employee or if they were looking for a *different business* in the reference week.

Col 77: (LOOKREAS) Main reason for looking for another job

When more than one reason had been mentioned the order of priority should be 1, 3, 4, 5, 6, 2, and 7, with 1 being the highest priority.

Information about second jobs

Col 78: (EXIST2J) Existence of more than one job or business

The same rules as for main job applies to determine whether the person is employed in his second job or not.

Col 79: (STAPRO2J) Professional status (in the second job)

See notes to Col 27 (Professional Status).

Col 80/81: (NACE2J2D) Economic activity of the local unit (in the second job)

The NACE codes in Annex II are derived from the Statistical Classification of Economic Activities. For the term "local unit" see notes to Col 29/31.

Col 82/83: (HWACTUA2) Number of hours actually worked during the reference week in the second job

See notes to Col 63/64. The number of hours given here corresponds to the number of hours the person actually worked during the reference week in the second job. This includes all hours including extra hours regardless of whether they were paid or not. Travel time between home and the place of work as well as the main meal breaks (normally taken at midday) are excluded.

Persons who have also worked at home (within the definitions given in the notes to Col 75) are asked to include the number of hours they have worked at home. Apprentices, trainees and other persons in vocational training are asked to exclude the time spent in school or other special training centres.

If the number of hours given by the respondent is not a complete number of hours the number should be rounded (ex: 37.5 hours should be coded 38).

Previous work experience of person not in employment

Col 84: (EXISTPR) Existence of previous employment experience

The previous employment experience should be an employment for pay or profit.

A person who only has in his work experience non-paid traineeships should be coded 0 here.

For people on lay-off (WSTATOR= 3), this question refers to the job that they have been laid-off.

In the case of a student who had been continuously performing PAID work alongside with studies, then that experience should be looked upon as a previous work experience, even if the amount of hours was limited.

Col 85/88: (YEARPR) Year in which person last worked

Although compulsory military or community service is not regarded as employment in the framework of the survey, respondents who, after having left their last job, were conscripts on compulsory military or community service should indicate the month and year in which they completed this service in order that this period is not counted in the unemployment duration.

For people on lay-off, this question refers to the job that they have been laid-off. Purely occasional job or vacation work does not include small jobs that are extended over a longer period of time, such as students working few hours every weekend during the school-year.

Col 89/90: (MONTHPR) Month in which person last worked

Although compulsory military or community service is not regarded as employment in the framework of the survey, respondents who, after having left their last job were conscripts on compulsory military or community service should indicate the month and year in which they completed this service in order that this period is not counted in the unemployment duration.

For people on lay-off, this question refers to the job that they have been laid-off.

Col 91/92: (LEAVREAS) Main reason for leaving last job or business

Due to recall problems this variable is restricted to those who had stopped work within the last 8 years, nevertheless if the person has not answered in which year they have last worked, he/she should answer the present question.

Code 00: Dismissed or made redundant

This code is used for employees whose employment ended involuntarily. It includes those employees who were dismissed, made redundant, or lost their job because their employer either went out of business, or sold or closed down the business.

Code 01: A job of limited duration has ended

This code is used for employees who declare that their last job was temporary and came to an end, or that they had a formal work contract which was completed. This also applies to seasonal and casual jobs.

Code 02: Looking after children or incapacitated adults

Care includes all care responsibilities:

- For own children or spouse children living inside or outside the household
- For other children (up to 14) living inside or outside the household
- For adult ill/elderly/incapacitated/disabled relatives/friends (aged 15 or more)

But excludes:

- Care as a job (it means that care done in a professional capacity is excluded).
- Care as a volunteer work (e.g. for a charity organisation)

In both cases, they should be coded as 09.

Code 03: Other personal or family responsibilities

Other personal or family responsibilities may include marriage, pregnancy, long vacation etc. However, if the respondent left his/her job because of personal health-related reasons then code 04 should be used.

Code 06: Early retirement

This code applies to those employees who have taken the early retirement option due to economic factors (labour market problems, difficulties in specific sectors of the economy, etc.), before the normal retirement age in his activity. If the respondent retired from his/her job at the normal retirement age then code 07 should be used.

Code 09: Other reasons

This code is used where none of the codes 00-08 applies, including cases where the person has resigned from his job for reasons (such as personal dissatisfaction) not covered by any of the other codes. Self-employed persons who went out of business, or sold or closed down the business should also be coded 09. People on lay-off should also belong to this category.

Col 93: (STAPROPR) Professional status in last job

See notes for Col 27. Due to recall problems this variable is restricted to those who had stopped work within the last 8 years, nevertheless if the person has not answered in which year they have last worked, he/she should answer the present question.

For people on lay-off, this question refers to the job that they have been laid-off.

Col 94/95: (NACEPR2D) Economic activity of the local unit in which person last worked

See notes for Col 29/31. The NACE codes in Annex II are derived from the Statistical Classification of Economic Activities. For the term "local unit", see notes to Col 29/31.

Due to recall problems this variable is restricted to those who had stopped work within the last 8 years, nevertheless if the person has not answered in which year they have last worked, he/she should answer the present question.

For people on lay-off (Col 24 = 3), this question refers to the job that they have been laid-off.

Col 96/98: (ISCOPR3D) Occupation of last job

See notes for Col 32/35. This should be coded according to the ISCO-COM classification provided in Annex III.

Due to recall problems this variable is restricted to those who had stopped work within the last 8 years, nevertheless if the person has not answered in which year they have last worked, he/she should answer the present question.

For people on lay-off, this question refers to the job that they have been laid-off.

Search for employment

Col 99: (SEEKWORK) Seeking employment during previous four weeks

The period of reference for this variable is the last four weeks ending with the reference week, in order to remain consistent with the variables concerning the methods used during the previous four weeks.

Due to the importance of this question in defining the unemployed, every effort should be made to ensure that an answer is given to this question. 'Blanks' are not allowed.

Those people not seeking employment are questioned on their willingness to work at Col 116.

Persons coded 2 are considered as 'not searching anymore' since they have already found a job. In case they are still searching for a work, they should be coded as 4.

Code 1 and 2: Person has already found a job to start later

This applies to all persons without a job during the reference week, and who have already found a job which will start later. Persons who were coded 1 in this variable

are considered as unemployed when they are available for work in the two weeks after the reference week. Those coded 2 are considered inactive because they were not looking for a job (otherwise they would have been coded 4). The period of 3 months considered follows the week of reference.

Code 4: Person is seeking employment

Also considered as seeking employment is a person who seeks an opportunity of professional training within an enterprise, e.g. as an apprentice or trainee.

Col 100: (SEEKREAS) Reasons for not seeking employment

Code 1: Awaiting recall to work (persons laid-off)

This code is to re-identify those persons who in Col 24 state they are laid-off and not seeking employment.

Code 03: Looking after children or incapacitated adults

Care includes all care responsibilities:

- For own children or spouse children living inside or outside the household
- For other children (up to 14) living inside or outside the household
- For adult ill/elderly/incapacitated/disabled relatives/friends (aged 15 or more)

But excludes:

- Care as a job (it means that care done in a professional capacity is excluded).
- Care as a volunteer work (e.g. for a charity organisation)

In both cases, they should be coded as 8.

Code 7: Belief that no work is available.

This code permits the estimation of the number of "discouraged workers".

Col 101: (SEEKTYPE) Type of employment sought (or found)

Code 1: As self-employed

Persons seeking self-employment, who are without employment during the reference week, are also asked under Col 110-111 whether they have taken any active steps during the past 4 weeks to set up a business, farm or professional practice.

Codes 2/5: Only full-time/part-time job is looked for (or has already been found)

Persons having already found a job as employee which will start later should be coded either 2 or 5 depending on whether the job found is full-time or part-time. Codes 3 and 4 do not apply for this group.

When the person does not know which type of employment he is looking for, it is as to be coded 6 unless he took active steps to be self-employed (code 1 in this case).

Col 102: (SEEKDUR) Duration of search for employment

The period of search should be the last continuous period of active search without significant interruption (in this case significant means at least four weeks).

For people who have found a job which will start later the period of search starts at the beginning of the search and ends when the person finds the job.

Methods used during previous weeks to find work

Col 103 to 115: (METHOD(A-M))

The 11th principle for the formulation of the question of the labour status (Commission Regulation 1897/2000) states that: "Questions are enumerated until at least three active methods have been mentioned".

Blanks are not allowed. If a person does not know or refuses to answer this should be coded as 0.

Only the methods used during the four weeks ending with the reference week are to be recorded

Col 103: (METHODA) Contacted public employment office to find work

"The 'contact with the public employment office to find work' only involves:

- putting the respondent's names in the employment office files for the first time (after a spell of employment or inactivity)
- finding out about possible job vacancies, or
- 'at the initiative of the employment office a suggestion of a job opportunity', which may be accepted or refused by the job searcher."

Contacts through the website of the public employment office with the objective of finding a job should be coded 1 (yes).

Col 107: (METHODD) Inserted or answered advertisements in newspapers or journals

The insertion or the answer of advertisements from a website (excepted website of public employment service) should be coded 1 here.

Col 108: (METHODF) Studied advertisements in newspapers or journals

The consultation of job advertisements in internet and the consultation of list of job vacancies in the entrance of the factories should be coded as 1 (yes).

Col 115: (METHODM) Other method used

In this Column, the answer "yes" should be recorded only if the person has used an active method not covered by Col 103 to 111. Passive methods not coded before should be coded no.

Use of Internet should not be considered as a separate method, but as a mode of the relevant methods in Col 103 to 111. Browsing the internet to look for available job openings is thus a mode of reading advertisements in journals and newspapers.

Sending an inquiry through a web-side form or e-mail to a public employment office in order to find a job is thus contact with a public employment office for the purpose of finding a job, etc.

Col 116: (WANTWORK) Willingness to work for person not seeking employment

This question is intended to permit a more exact measure for "discouraged workers". It is put to persons coded 3 Col 99, i.e. without employment and not seeking employment. Discouraged workers are persons who are not seeking work because they believe that none is available (Col 100=7) but would nevertheless like to have a job (Col 116=1).

The reference period of this question is the reference week, but it is not necessary to mention it in the questionnaire. The person is asked whether he/she would like to have a paid employment, whatever the number of hours worked.

Col 117: (AVAILBLE) Availability to start working within two weeks

'Immediately available' means that if a job were found at the time of the interview, the person would be able to start work within two weeks.

Testing for availability in the two weeks following the reference week is considered more appropriate than testing during the reference week, because some persons may be unavailable for work during the reference week due to obstacles that might have been overcome had they known that a job was available to them.

Col 118: (AVAIRESAS) Main reason for not being available to start working within two weeks

The variable is used to set the position of inactive people with respect to the labour market. Ask spontaneous reasons. Main reason should be collected.

Col 119: (PRESEEK) Situation immediately before person started to seek employment

If more than one category applies, the main situation should be coded.

If the person did not search employment because the job was offered, the situation to be coded is the one when the job was offered.

Col 120: (NEEDCARE) Need for care facilities

Care includes all care responsibilities:

- for own children or spouse children living inside or outside the household
- for other children (up to 14) living inside or outside the household
- for adult ill/elderly/incapacitated/disabled relatives/friends (aged 15 or more)

But excludes:

- Care as a job (it means that care done in a professional capacity is excluded).
- Care as a volunteer work (e.g. for a charity organisation)

The need for care services can be a need for normal working hours or for special periods of day (very early in the morning or late evening) or for special periods of the year (e.g. school holidays).

Care services exclude the unpaid help by relatives, friends or neighbours. The care services can be private or subsidised by the State or the employers and consequently paid or not paid.

Some examples of care services could be crèche, day care centre, organised family care (e.g. family crèches, home-based care by childminders affiliated to a child minding service), after school centre, paid carers, specialised centres for persons with disabilities, institutions, assistance at home.

The word "suitable" means the minimum standards of quality that the person requests from a care service. This notion of quality involves schedules, quality of the personnel, specific expertise to care for the particular care needs (e.g. disability) in question, etc.

The word “available” means at a reasonable distance, taking into account also the means of transport and currently open/available for use to the respondent.

The word “affordable” should take into account the relation/balance between:

- an eventual future salary for the person who would work or work more if care services were available
- and the cost of the care service.

Col 121: (REGISTER) Registration at public employment office

Only people who are registered at a public employment office as job-seekers should be coded 1 or 2.

For persons having declared themselves to be seeking employment this question should be the last in the section on seeking employment, as it is important not to give the subject of registration too much emphasis in defining the unemployed.

Since unemployment will basically be defined by the criteria of job search and availability for work the respondents' answer to these questions should not be conditioned by whether or not they are registered at an official employment exchange.

Persons who are in employment and who register in a public employment office to find another job should be coded 2 or 1 (for those who receive complementary unemployment benefits).

Benefits, in this context should be limited to allowances linked with unemployment status (not other social benefits).

The reference period of this question should be end of the reference week.

Main status

Col 122: (MAINSTAT) Main status

The “main activity status” gives each person’s self-perception regarding his/her activity status; for instance, students with small jobs will in general present themselves as students. The reference period for this variable is the reference week.

This question shouldn’t in any case precede the questions on the labour status according to the ILO definition or the questions on the registration at the public employment office.

Code 8 should also be used to classify persons who cannot say they are “carrying out a job or profession” nor fit into other groups but on an extended leave from such a job.

Education and training

Col 123: (EDUCSTAT) Student or apprentice in regular education during the last four weeks

Regular (formal education) is defined as education and training with the following characteristics:

- purpose and format are predetermined
- provided in the system of schools, colleges, universities and other educational institutions
- it normally constitutes a continuous ladder of education.

- it is structured in terms of learning objectives, learning time and learning support
- it is normally intended to lead to a certification recognised by national authorities (qualifying for a specific education/programme).
- corresponds to the programmes covered by the UOE-questionnaires.

The list of national programmes covered by the UOE-questionnaire is found at the address:

http://forum.europa.eu.int/Public/irc/dsis/edtc/library?l=/public/unesco_Collection/programmes_isced97&vm=detailed&sb=Title

Apprentice: student in regular education but completing his/her studies by apprenticeship foreseen in the educational programme (even if paid).

This variable only covers the regular education system (formal education, including schools, Colleges and universities) and which the respondent has attended sometime during the last 4 weeks period ending with the reference week.

If the interviewee is enrolled as a student or an apprentice in a programme within the regular education system the answer is code 1. This includes modules (short programmes/courses) which may be part of a longer regular education programme and are taken and completed, giving to their graduates the corresponding academic credit, independent of whether the person continues to complete the full programme or not. The field and level of the short programmes/courses will be the same as the programme of which they form part.

For apprentices who in the past 4 weeks are in a period of only 'on-the-job training' or alternate 'on-the-job' and 'in-school learning' within the framework of an alternate (e.g. dual) programme, the answer is code 1, since the person is enrolled in a qualifying programme.

Code 3 (person in regular education but on holidays) applies for students enrolled but on school holidays and for those who will continue their studies after holidays.

The purpose of this code is to eliminate to minimum in the summer interviews doubts about being in regular education (codes 1 and 3 to be considered together). It is very difficult to give precise rules for each case but it could be recommended to take into account the situation of the person in the previous educational period (in spring), what corresponds probably to a natural answer from respondents. The subjective perception of this situation has to be respected in the case if the respondent does not know yet about his/her situation after holidays (exams to be passed in the second session, not yet reply received from the educational institution concerning the new studies, etc).

Col 124: (EDUCLEVL) Level of the current education or training

Level refers to the programme mentioned in Col 123.

Level is coded according to the International Standard Classification of Education 1997 and consists of only levels without destination (educational or labour market: A-C) or orientation (general, pre-vocational, vocational).

- ISCED 1 Primary education
- ISCED 2 Lower secondary education
- ISCED 3 Upper secondary education
- ISCED 4 Post secondary education, non-tertiary
- ISCED 5 Tertiary education

- ISCED 6 Postgraduate education

Level 4 may not exist in some countries. Please check your ISCED-mapping.

For the persons coded 3 in Col 123 (*Student or apprentice in regular education during the last four weeks*), the educational level of the education or training attended before their holidays.

If the respondent has been enrolled in several educational programmes during the reference period he/she should only give information on the highest level of educational programme.

Col 125/127: (EDUCFILD) Field of the current education or training

If the respondent has been enrolled in several educational programmes during the reference period he/she should only give information on the field in the highest level of educational programme.

Col 128: (COURATT) Did you attend any courses, seminars, conferences or receive private lessons or instructions outside the regular education system (hereafter mentioned as taught learning activities, job-related or for personal purposes) within the last four weeks

This variable covers all taught organised learning activities outside the regular education system and which the respondent has attended during the last four weeks ending with the reference week. This is what may be called non-formal education and training.

A non-formal learning activity is defined as being organised like a course, a conference or seminar for which the interviewee has applied and has participated in. It could be for a short or a longer period also with minor breaks.

A non-formal learning activity may exceed the reference period (starting before or finishing later). It includes the following activities:

- Attending a course or a seminar to acquire or to improve skills, knowledge and competence. This includes both courses leading to certificates and courses not leading to certificates. The courses can be attended to improve job related knowledge or improve skills for social and personal purposes.
- Attending a seminar, a course or a lecture to gain vocational guidance and to give a first step to working life (but outside formal education). This includes measures which show and analyse the labour market, his or hers needs and possibilities and which help to choose a job and also measures which improve basic skills/key skills in public or private institutions. The training is taught and within a group on full time basis (or maybe part time) for a shorter period.
- Doing a correspondence course, a tele-teaching or a comparable measure of teacher-supported distance learning to improve skills, knowledge or competence.
- Taking private lessons to improve skills, knowledge and competence, especially as a supplement to formal education. This includes supplementary course by a private tutor. Leisure classes for example studying a language for 'leisure' purposes, even if the qualifications achieved may correspond to (part of) A-level, the attendance should be considered as a non-formal 'course'.

Col 129/131: (COURLEN) Number of hours spent on all taught learning activities within the last four weeks

Duration in number should reflect the number of taught hours only. The definition of total time spent in taught learning by the individual is the total number of hours that the individual has spent on participating in classes, seminars, conferences, lectures, tutorials etc. or receiving instruction or advice. Only the hours of instruction should be included in the total time spent in taught learning, which means that travelling time and homework should be excluded.

Col 132: (COURPURP) Purpose of the most recent taught learning activity

Job-related (professional): the respondent takes part in this activity in order to obtain knowledge and/or learn new skills for a current or a future job, increase earnings, improve job- and/or carrier opportunities in a current or another field and generally improve his/her opportunities for advancement and promotion.

Non job-related (personal/social): the respondent takes part in this activity in order to develop competencies required for personal, community, domestic, social or recreational purposes.

Col 133/135: (COURFILD) Field of the most recent taught learning activity

Although the classification used does not cover the very broad offer of subjects in courses, conferences, seminars etc, it is coded in the same way as programmes under HATFIELD (Col 139/141) and EDUCFIELD (Col 125/127) to facilitate implementation and allow aggregation.

Col 136: (COURWORH) Did the most recent taught learning activity take place during paid working hours?

This variable informs on the support to the course by the employer. It refers to the degree that the activity takes place during paid working hours meaning that the working hours are used to attend the activity instead of working. It also includes the case of where a number of working hours are being replaced by learning activity even if the activity itself takes place outside normal working time of the respondent.

If the learning activity takes place outside normal working time and the respondent has received payment for the hours or additional leisure hours, the activity should be coded as during paid working hours.

The answer should only reflect the participation in the course itself and not homework.

For self-employed normal working time instead of paid hours should be taken into account.

Contributing family workers (those workers who hold a 'self-employment' job in a market-oriented establishment operated by a related person living in the same household), who cannot be regarded as partners, voluntary social workers and others working without being paid but attending a course within that area should be coded as "4: Only outside paid hours", as there are no paid working hours.

If a person attends a long course (within the reference period) and does not have a job all the time of the course, there will be two periods of the course: the period where the person is in job and the period where the person is not in job. The answer and coding

should reflect the situation in the longest period of the course (again within the reference period).

Col 137/138: (HATLEVEL) Highest level of education or training successfully completed
Level is coded according to the International Standard Classification of Education (ISCED 97).

Persons with no education (illiterate) should be coded 00.

The expression "level successfully completed" must be associated with obtaining a certificate or a diploma, when there is a certification. In cases where there is no certification, successful completion must be associated with full attendance.

When determining the highest level, both general and vocational education/training should be taken into consideration.

Persons who have not completed their studies should be coded according to the highest level they have completed and should not be coded with a blank.

Code 30 should only be used in those cases in which a distinction a, b, c of ISCED 3 is not possible.

Col 139/141: (HATFIELD) Field of highest level of education or training successfully completed

Field is coded according to the "Manual on fields of education and training", EUROSTAT 1999.

ISCED 97 contains 25 two-digit fields of education. The classification used here goes up to a three-digit code in a hierarchical system for classifying fields of education, where the two-digit level is the ISCED 97 fields of education. It is mainly the first two digits that are used in international data collection. However, the third digit gives a more flexible system, and other aggregations based on the third digit may be used in ad hoc data collections to suit specific purposes.

The rule for coding is that the respondents should be coded with the most detailed code possible and only with one code.

Col 142/145: (HATYEAR) Year when highest level of education or training was successfully completed

The expression "level successfully completed" must be associated with obtaining a certificate or a diploma, when there is a certification. In cases where there is no certification, successful completion must be associated with full attendance.

Situation one year before survey

The information collected through the following questions in this section, are used to assess mobility of various types: between employment, unemployment and inactivity; of professional status; of economic activity; geographical mobility. Clearly such mobility measures, based upon the respondent's situation at two points in time, can only indicate at most one change in each case (for example, from unemployed to

employed), whereas in fact several changes may have taken place over this period (for example, unemployed - employed - inactive - employed). Also, the International Labour Organisation definitions used elsewhere in the survey cannot be applied here, since not all the questions necessary can be asked (for example, availability for work, job search, etc.). The variables “current main status” and “main status one year before the survey” have exactly the same structure in order to permit these comparisons.

Col 146: (WSTAT1Y) Situation with regard to activity one year before survey

The reference period of this question is the week one year before the reference week.

Code 6: Person was conscripted on compulsory military or community service

Although conscripts on compulsory military or community service are excluded from the survey results, this code identifies persons who were conscripts a year before the survey. This is important in identifying labour force entrants.

Col 147: (STAPRO1Y) Professional status one year before survey

For the codification, see variable STAPRO (Col 27)

Col 148/149: (NACE1Y2D) Economic activity of local unit in which person was working one year before survey

See variable NACE3D (Col 29/31). The NACE codes in Annex II are derived from the Statistical Classification of Economic Activities.

Col 150/151: (COUNTRY1Y) Country of residence one year before survey

For coding, see ISO country classification (see Annex IV). This refers to the usual residence one year before.

Col 152/153: (REGION1Y) Region of residence one year before survey

This is based on NUTS 2 (see Annex 1). This refers to the usual residence one year before.

Income

Col 154/155: (INCDECIL) Monthly (take-home) pay from main job

The monthly (take-home) pay is the pay after (provisional, subject to revision later) deduction of income tax and National Insurance Contributions. It includes regular overtime, extra compensation for shift work, seniority bonuses, regular travel allowances and per diem allowances, tips and commission, compensation for meals. Income from investments – assets, savings, stocks and shares... should not be included in monthly wages and salaries.

Holiday bonuses (13th and/or 14th month) and fringe benefits should be considered dividing their amount by 12.

If the job is an occasional job for a short period, the amount should be an estimate of the total earnings from all similar jobs in that month.

The deciles should be calculated and provided once data for the whole year are collected, checked, and corrected from the non-response.

The first decile (code 01) should refer to people with lowest wages, the 10th (code 10) should refer to people with highest wages.

Technical items relating to the interview

Col 156/159: (REFYEAR) Year of survey

This variable refers to the year in which the Thursday of the reference week belongs.

Col 160/161: (REFWEEK) Reference week

The reference weeks should follow the Norm ISO 8601 which indicates that, according to the Gregorian calendar, the first week of the year is the one that includes the first Thursday of that year.

Concretely:

- Week 1 of 2008 starts the 31st December 2007
- Week 1 of 2009 starts the 29th December 2008
- Week 1 of 2010 starts the 4th January 2010
- Week 1 of 2011 starts the 3rd January 2011

As the year has 365 days (except leap years which have 366 days) and the quarterly survey covers 364 days ($52 \times 7 = 364$), every year the Thursday of the first week of the first quarter moves (backward) to the previous day of the month. After some years that Thursday will be the 31st of December of year Y-1. In this case the sample should be spread over 14 weeks.

Col 162/163: (INTWEEK) Interview week

This information used with reference week gives an indication of the recall period and information on the quality of the answer.

Col 164/165: (COUNTRY) Country

This should be provided according to the coding in Annex IV.

Col 166/167: (REGION) Region of household

This should be provided to the coding system in Annex I, which is based on the Classification of Territorial Units (NUTS). The third and fourth digits of the NUTS code (that is, the level II regional code) should be provided.

Col 168: (DEGURBA) Degree of urbanisation

The concept of "urbanisation" has been introduced to indicate the character of the area where the respondent lives. Three types of area have been identified, as follows:

- densely-populated (Code 1)
- intermediate (Code 2)
- thinly-populated (Code 3)

In the definition of "Degree of urbanisation" there is a criterion of geographical contiguity together with a population threshold. Harmonised, comparable correspondence between the Degree of Urbanisation and NUTS 5 regions has been (re-)defined on the basis of 2001 census data (for Member States and Candidate countries) in 2005.

An "area" consists of a group of contiguous "local areas" where a "local area" corresponds to the following entities in the respective countries:

Labour Force Survey - United Kingdom

| | | |
|-----------------|--|--------|
| Belgium | Gemeenten/Communes | |
| Czech Republic | Obce | 6,249 |
| Denmark | Kommuner | 271 |
| Germany | Gemeinden | 13,176 |
| Estonia | Vald, Inn | 241 |
| Greece | Demotiko diamerisma/Koinotiko diamerisma | 6,130 |
| Spain | Municipios | 8,108 |
| France | Communes | 36,678 |
| Ireland | DEDs/Wards | 3,440 |
| Italy | Comuni | 8,100 |
| Cyprus | Dimoi, koinotites | 614 |
| Latvia | Pilsētas, novadi, pagasti | 530 |
| Lithuania | Seniūnijos | 515 |
| Luxembourg | Communes | 118 |
| Hungary | Települések | 3,145 |
| Malta | Kunsilli | 68 |
| The Netherlands | Gemeenten | 489 |
| Austria | Gemeinden | 2,381 |
| Poland | Gminy | 2,478 |
| Portugal | Freguesias | 4,257 |
| Slovenia | Občine | 193 |
| Slovakia | Obce | 2,928 |
| Finland | Kunnat /Kommuner | 446 |
| Sweden | Kommuner | 290 |
| United Kingdom | Wards (or parts thereof) | 10,679 |
| Bulgaria | Naseleni Mesta | 5,340 |
| Croatia | | |
| Romania | Communes+ Municipiu +Orajse | 2,951 |
| Turkey | Köy | 37,675 |
| Iceland | Sveitarfélag | 101 |
| Norway | Kommuner | 433 |
| Switzerland | Gemeinden / Communes / Comuni | 2,815 |

The three types of area described above are defined as follows:

Code 1: Densely-populated area

This is a contiguous set of local areas, each of which has a density superior to 500 inhabitants per square kilometre, where the total population for the set is at least 50,000 inhabitants.

Code 2: Intermediate area

This is a contiguous set of local areas, not belonging to a densely-populated area, each of which has a density superior to 100 inhabitants per square kilometre, and either with a total population for the set of at least 50,000 inhabitants or adjacent to a densely-populated area.

Code 3: Thinly-populated area

This is a contiguous set of local areas belonging neither to a densely-populated nor to an intermediate area.

A set of local areas totalling less than 100 square kilometres, not reaching the required density, but entirely enclosed within a densely-populated or intermediate area, is to be considered to form part of that area. If it is enclosed within a densely-populated area and an intermediate area it is considered to form part of the intermediate area.

Col 169/174: (HHNUM) Serial number of the household

Serial numbers are allocated by the national statistical institutes and remain the same for all waves. Records relating to different members of the same household carry the same serial number.

Col 175: (HHTYPE) Type of household

A private household (housekeeping unit concept) is either:

- a) a one-person household, i.e. a person who lives alone in a separate housing unit or who occupies, as a lodger, a separate room (or rooms) of a housing unit but does not join with any of the other occupants of the housing unit to form part of a multi-person household as defined below, or
- b) a multi-person household, i.e. a group of two or more persons who combine to occupy the whole or part of a housing unit and to provide themselves with food and possibly other essentials for living. Members of the group may pool their incomes to a greater or lesser extent.

The household-dwelling concept (the aggregate number of persons occupying a housing unit) can equally be accepted.

These definitions comprise all persons living in the households surveyed during the reference week, and those persons absent from the household for short periods due to studies, holidays, illness, business trips, etc. In this context short period means less than one year in total (time already elapsed plus the time remaining until the foreseen return).

An institutional household comprises persons whose need for shelter and subsistence are being provided by an institution.

Col 176: (HHINST) Type of institution

This gives information on the distribution of the population by type of collective household.

Col 177/182: (COEFFY) Yearly weighting factor

Each person in the survey sample may be considered to be "representative" of a certain number of other persons not in the sample. The record for each responding individual is therefore assigned a weighting indicating how many persons are in this sense "represented" by this individual.

In order to have consistency between individual and household statistics the same weighting factor should be allocated to all the members of the household.

The '4 first digits' should correspond to whole numbers and the '2 last digits' should correspond to decimal places (without any coma before).

Col 183/188: (COEFFQ) Quarterly weighting factor

In order to have a measure of each variable at quarterly level a quarterly weighting factor should also be calculated. See also notes for Col 183/188 (*Yearly weighting factor*).

Countries still having a yearly survey are requested to fill these columns with the Yearly weighting factor.

Col 189/194: (COEFFH) Yearly weighting factor of the sample for household characteristics (in the case of a sample of individuals)

According to Article 2, § 4. of the regulation for a continuous labour force survey, if the sampling unit is the individual, information can be collected for a sub-sample defined in such way that:

- The reference weeks are uniformly distributed throughout the whole year;
- The number of observations (individuals sampled plus the members of their household) satisfies, for the annual estimates of levels, the reliability criteria.

For countries providing household data using this kind of sub-sample (and only for these countries) this weighting factor should be calculated for each person composing the sub-sample.

Col 195: (INTWAVE) Sequence number of the survey wave

The sequence number of the wave should correspond to the number of times that the individual/household is in the sample. The quarters where the individual/household is not in the sample should be excluded from the counting.

For countries where the sample unit is the household, the sequence number of the survey wave is attached to the household. Therefore it should follow the same pattern for all individuals of the same household. For instance a new person joining the household (and the sample) in wave 2 would be assigned number 2. A person present in wave 1, absent in wave 2 but present in wave 3 would be assigned number 3 when interviewed in wave 3.

Col 196: (INTQUEST) Questionnaire used

Code 1 applies for interviews that do not use the whole questionnaire (yearly + quarterly variables).

Levels of Education and Training

ISCED 0 - Pre-primary Education

Programs at level 0, (pre-primary) defined as the initial stage of organised instruction is designed primarily to introduce very young children to a school-type environment, i.e. to provide a bridge between the home and a school based atmosphere. Upon completion of these programs, children continue their education at level I (primary education).

ISCED I - Primary Education or First Stage of Basic Education

Programmes at level I are normally designed on a unit or project basis to give students a sound basic education in reading, writing and mathematics along with an elementary understanding of other subjects such as history, geography, natural science, social science, art and music. In some cases religious instruction is featured. The core at this level consists of education provided for children, the customary or legal age of entrance being not younger than five years or older than seven years. This level covers, in principle, six years of full-time schooling.

ISCED 2 - Lower Secondary Education or Second Stage of Basic Education

The contents of education at this stage are typically designed to complete the provision of basic education which began at ISCED level 1. In many, if not most countries, the educational aim is to lay the foundation for lifelong learning and human development. The programmes at this level are usually on a more subject oriented pattern using more specialised teachers and more often several teachers conduct classes in their field of specialisation. The full implementation of basic skills occurs at this level. The end of this level often coincides with the end of compulsory schooling where it exists.

ISCED 3 - (Upper) Secondary Education

This level of education typically begins at the end of full-time compulsory education for those countries that have a system of compulsory education. More specialisation may be observed at this level than at ISCED level 2 and often teachers need to be more qualified or specialised than for ISCED level 2. The entrance age to this level is typically 15 to 16 years. The educational programmes included at this level typically require the completion of some 9 years of full-time education (since the beginning of level 1) for admission or a combination of education and vocational or technical experience.

ISCED 3A: Programmes designed to provide direct access to ISCED 5A;

ISCED 3B: Programmes designed to provide direct access to ISCED 5B;

ISCED 3C: Programmes not designed to lead to ISCED 5A or 5B.

ISCED 4 - Post-Secondary Non Tertiary Education

ISCED 4 captures programmes that straddle the boundary between upper secondary and post-secondary education from an international point of view, even though they might clearly be considered as upper secondary or post-secondary programmes in a national context. These programmes can, considering their content, not be regarded as tertiary programmes. They are often not significantly more advanced than programmes at ISCED 3 but they serve to broaden the knowledge of participants who have already completed a programme at level 3.

Typical examples are programmes designed to prepare students for studies at level 5 who, although having completed ISCED level 3, did not follow a curriculum which would allow entry to level 5, i.e. pre-degree foundation courses or short vocational programmes. Second cycle programmes can be included as well.

ISCED 4A: See text for ISCED 3

ISCED 4B: See text for ISCED 3

ISCED 4C: See text for ISCED 3

LEVEL 5 - First Stage of Tertiary Education (not leading directly to an advanced research qualification)

This level consists of tertiary programmes having an educational content more advanced than those offered at levels 3 and 4. Entry to these programmes normally requires the successful completion of ISCED level 3A or 3B or a similar qualification at ISCED level 4A. They do not lead to the award of an advanced research qualification (ISCED 6). These programmes must have a cumulative duration of at least two years.

ISCED 5A: Programmes that are largely theoretically based and are intended to provide sufficient qualifications for gaining entry into advanced research programmes and professions with high skills requirements.

ISCED 5B: Programmes that are practically oriented/ occupationally specific and are mainly designed for participants to acquire the practical skills and know-how needed for employment in a particular occupation or trade or class of occupations or trades, the successful completion of which usually provides the participants with a labour-market relevant qualification

ISCED 6 - Second Stage of Tertiary education (leading to an advanced research qualification)

This level is reserved for tertiary programmes which lead to the award of an advanced research qualification. The programmes are therefore devoted to advanced study and original research and not based on course-work only.

They typically require the submission of a thesis or dissertation of publishable quality which is the product of original research and represents a significant contribution to knowledge. They prepare graduates for faculty posts in institutions offering ISCED 5A programmes, as well as research posts in government, industry, etc.

Programme Orientation

General Education

Education which is mainly designed to lead participants to a deeper understanding of a subject or group of subjects, especially, but not necessarily, with a view to preparing participants to higher (additional) education at the same or a higher level. Successful completion of these programmes may or may not provide the participants with a labour-market relevant qualification. These programmes are typically school-based. Programmes with a general orientation and not focusing on a particular specialisation should be classified in this category.

Pre-vocational and Pre-technical education

Education which is mainly designed to introduce participants to the world of work and to prepare them for entry into vocational and technical education programmes. Successful completion of such programmes does not yet lead to a labour-market relevant vocational or technical qualification. For a programme to be considered as pre-vocational or pre-technical education, at least 25% of its content has to be vocational or technical. This minimum is necessary to ensure that the vocational subject or the technical subject is not only one among many others.

Vocational and technical education

Education which is mainly designed to lead participants to acquire the practical skills, know-how and understanding necessary for employment in a particular occupation or trade or class of occupations or trades. Successful completion of such programmes leads to a labour-market relevant vocational qualification recognised by the competent authorities in the country in which it is obtained (e.g. Ministry of Education, employers' associations, etc.).

SECTION 8: EUROSTAT AD HOC MODULES

Under Regulation (EC) No 577/98, EuroStat includes a number of variables each year which provide information on aspects of the labour market that do not form part of the standard questionnaire. This set of variables, constitute an "ad hoc module".

| Regulations adopting the programme of ad hoc modules | Regulations adopting the specifications | Ad hoc module description | Year |
|--|--|---|------|
| <u>Commission Regulation (EC) No 365/2008</u> of 23 April 2008 adopting the programme of ad hoc modules covering the years 2010 to 2012 | * | Transition from work into retirement | 2012 |
| | * | Employment of disabled people | 2011 |
| | <u>Commission Regulation (EC) No 20/2009</u> | Reconciliation between work and family life | 2010 |
| <u>Commission Regulation (EC) No 384/2005</u> of 7 March 2005 adopting the programme of ad hoc modules, covering the years 2007 to 2009 | <u>Commission Regulation (EC) No 207/2008</u> | Transition from school to work life | 2009 |
| | <u>Commission Regulation (EC) No 102/2007</u> | Labour Market situation of migrants and the immediate descendants of migrants | 2008 |
| | <u>Commission Regulation (EC) No 391/2008</u> (amendment concerning BG and RO) | | |
| | <u>Commission Regulation (EC) No 341/2006</u> | Accidents at work and work-related health problems | 2007 |
| <u>Commission Regulation (EC) No 246/2003</u> of 10 February 2003 adopting the programme of ad hoc modules, covering the years 2004 to 2006 | <u>Commission Regulation (EC) No 388/2005</u> | Transition from work into retirement | 2006 |
| | <u>Commission Regulation (EC) No 29/2004</u> | Reconciliation between work and family life | 2005 |
| | <u>Commission Regulation (EC) No 247/2003</u> | Work organisation and working time arrangements | 2004 |
| <u>Commission Regulation (EC) No 1626/2000</u> of 24 July 2000 adopting the programme of ad hoc modules, covering the years 2001 to 2004 | <u>Commission Regulation (EC) No 1313/2002</u> | Lifelong learning | 2003 |
| | <u>Commission Regulation (EC) No 1566/2001</u> | Employment of disabled people | 2002 |
| | <u>Commission Regulation (EC) No 1578/2000</u> | Length and patterns of working time | 2001 |
| <u>Commission Regulation (EC) No 1924/1999</u> of 8 September 1999 adopting the programme of ad hoc modules, covering the years 2000 to 2002 | <u>Commission Regulation (EC) No 1925/1999</u> | Transition from school to working life | 2000 |
| | <u>Commission Regulation (EC) No 1571/98</u> | Accidents at work and occupational diseases | 1999 |

* Under discussion

For more information on Eurostat ad hoc modules: -
http://circa.europa.eu/irc/dsis/employment/info/data/eu_lfs/LFS_MAIN/LFS/lfs_regulations.htm

Specifications of the 2010 ad hoc module on the entry of young people into the labour market

| Column | Code | Description | Filters/remarks |
|--------|----------|---|--|
| 197 | REGCARE | <i>Person regularly takes care of other children up to 14 (other than own/spouse's children living in the household) or of ill, disabled, elderly relatives/friends aged 15 or more in need of care</i> | Everybody aged 15 to 64 |
| | 1 | Yes, of other children up to 14 | |
| | 2 | Yes, of relatives/friends aged 15 or more in need of care | |
| | 3 | Yes, of other children up to 14 and of relatives/friends aged 15 or more in need of care | |
| | 4 | No | |
| | 9 | Not applicable (not included in the filter) | |
| | Blank | No answer | |
| 198 | CHILDCAR | <i>Use of childcare services per week for the youngest child living in the household (including paid childminders, pre-school; apart from compulsory school)</i> <i>Childcare services are used for ... per week</i> | Everybody aged 15 to 64 with at least one own/spouse's child up to 14 living in the household |
| | 1 | — up to 10 hours | |
| | 2 | — more than 10 hours and up to 20 hours | |
| | 3 | — more than 20 hours and up to 30 hours | |
| | 4 | — more than 30 hours and up to 40 hours | |
| | 5 | — more than 40 hours | |
| | 6 | — No use of childcare services | |
| | 9 | — Not applicable (not included in the filter) | |
| | Blank | No answer | |
| 199 | IMPFACIL | <i>Impact of availability and affordability of care facilities on not working or working part-time</i> | Everybody aged 15 to 64 and (FTPTREAS ≠ 3 and SEEKREAS ≠ 3 and (REGCARE = 1-3 or has at least one own/spouse's child up to 14 living in the household)) and FTPT ≠ 1 |
| | 1 | Suitable care services for children are not available or affordable | |
| | 2 | Suitable care services for ill, disabled, elderly are not available or affordable | |
| | 3 | Suitable care services for both children and ill, disabled and elderly are not available or affordable. | |
| | 4 | Care facilities do not influence decision for labour market participation | |
| | 9 | Not applicable (not included in the filter) | |
| | Blank | No answer | |

Labour Force Survey - United Kingdom

| Column | Code | Description | Filters/remarks |
|--------|----------|---|--|
| 200 | NOWRECHI | <i>Main reason (linked with childcare) for not working or working part-time</i> | Everybody aged 15 to 64 and (NEEDCARE = 1,3 or IMPFACIL = 1,3) |
| | 1 | No childcare services available | |
| | 2 | Available childcare services are too expensive | |
| | 3 | Available childcare services are not of sufficient quality | |
| | 4 | Other reasons linked with the lack of suitable childcare services | |
| | 9 | Not applicable (not included in the filter) | |
| | Blank | No answer | |
| 201 | NOWRECAR | <i>Main reason (linked with care of other dependants) for not working or working part-time</i> | Everybody aged 15 to 64 and (NEEDCARE = 2,3 or IMPFACIL = 2,3) |
| | 1 | No care services available | |
| | 2 | Available care services are too expensive | |
| | 3 | Available care services are not of sufficient quality | |
| | 4 | Other reasons linked with the lack of suitable care services | |
| | 9 | Not applicable (not included in the filter) | |
| | Blank | No answer | |
| 202 | VARHOURS | <i>Variable working hours</i> | Everybody aged 15 to 64 and STAPRO = 3 |
| | 1 | Fixed start and end of a working day or varying working time as decided by the employer <i>Schedule decided by the employee within one of the following schemes:</i> | |
| | 2 | Flexitime/Working time banking | |
| | 3 | Daily number of hours fixed, but some flexibility within the day | |
| | 4 | Determines own work schedule (no formal boundaries at all) | |
| | 5 | Other | |
| | 9 | Not applicable (not included in the filter) | |
| | Blank | No answer | |
| 203 | POSSTEND | <i>Possible to vary start and/or end of working day for family reasons (at least one hour)</i> | VARHOURS = 1,3,5,blank |
| | 1 | Generally possible | |
| | 2 | Rarely possible | |
| | 3 | Not possible | |
| | 9 | Not applicable (not included in the filter) | |
| | Blank | No answer | |
| 204 | POSORGWT | <i>Possible to organise working time in order to take whole days off for family reasons (without using holidays)</i> | Everybody aged 15 to 64 and STAPRO = 3 |
| | 1 | Generally possible | |
| | 2 | Rarely possible | |
| | 3 | Not possible | |
| | 9 | Not applicable (not included in the filter) | |
| | Blank | No answer | |

| Column | Code | Description | Filters/remarks |
|---------|--|---|--|
| 205 | REDWORK 1 2 9 Blank | <i>Reduced working hours to take care of the youngest child in the household for at least one month (excluding maternity leave)</i> Yes No Not applicable (not included in the filter) No answer | Everybody aged 15 to 64 with at least one own/spouse's child up to the 8th birthday living in the household and (WSTATOR = 1,2 or (EXISTPR = 1 and REFYEAR-YEARPR <= age of the youngest child + 1)) |
| 206 | STOPWORK 1 2 3 4 5 6 9 Blank | <i>Stopped working to take care of the youngest child in the household for at least one month (excluding maternity leave)</i> No <i>Yes, stopped working for a completed period of:</i> — up to 3 months — more than 3 months and up to 6 months — more than 6 months and up to 1 year — more than 1 year Has not returned to work yet Not applicable (not included in the filter) No answer | Everybody aged 15 to 64 with at least one own/spouse's child up to the 8th birthday living in the household and (WSTATOR = 1,2 or (EXISTPR = 1 and REFYEAR-YEARPR <= age of the youngest child + 1)) |
| 207 | PARLEAVE 1 2 3 4 5 6 9 Blank | <i>Full-time parental leave of at least one month taken to care for the youngest child in the household (excluding maternity leave)</i> No, has not taken full-time parental leave for at least one month <i>Yes, has taken full-time parental leave for a completed period of:</i> — up to 3 months — more than 3 months and up to 6 months — more than 6 months and up to 1 year — more than 1 year Leave is still ongoing Not applicable (not included in the filter) No answer | Everybody aged 15 to 64 with at least one own/spouse's child up to the 8th birthday living in the household |
| 210/215 | 0000 - 9999 00 - 99 | <i>Weighting factor for the 2010 ad hoc module (optional)</i> Columns 210-213 contain whole numbers Columns 214-215 contain decimal places | Everybody aged 15 to 64 |

Explanatory Notes for LFS 2010 ad hoc module

Col 197: Person regularly takes care of other children up to 14 (other than own spouse's children living in the household) or of ill, disabled, elderly relatives/friends aged 15 or more in need of care.

The aim of REGCARE is to identify all care responsibilities undertaken by the person interviewed since all care responsibilities are susceptible to pose an obstacle for the labour market participation of the person. As it is generally assumed that parents with children up to 14 years (living in the household) have care responsibilities for those children, REGCARE addresses regular care for other children up to 14 and for relatives/friends aged 15 or more in need of care only. Care provided as professional care minder, as voluntary work or pure financial support are excluded.

Definition

“Caring”, “care”, and “carer”: the variable focuses on the carers and not on the persons who are cared for (employment perspective linked with care responsibilities). Carers are defined as people who look after or provide help to children or to friends/relatives in need of care because they are sick/elderly/incapacitated/disabled (help, assistance, support, surveillance).

Examples of caring tasks for other children up to 14: personal care, homework, playing games, reading, taking out, and surveillance.

Examples of caring tasks for friends/relatives in need of care aged 15 or more: personal care (e.g. dressing, washing), physical help (e.g. walking), helping with paperwork or financial matters, domestic help (e.g. housework, laundry) and company.

“Regularly” is defined as on a fixed pattern (every day, every week ...) and frequently (not only occasionally, for instance not only once in 3 months). The reference period is the current situation.

“Other children” correspond to other than own/spouse’s children living in the household that is to say to:

- own/spouse’s children living outside the household
- other children (not own/spouse’s) living inside or outside the household.

Implementation rule

- For own/spouse's children living in the household see the general remark above. Adopted children should be considered as own children, foster children as other children.
- Children aged 14 years old should be considered.
- Care for children aged 15 or more who are not ill/disabled is out of the scope of this variable.
- The adults taken care of can live inside or outside the household.
- If the care consists only of financial support or if the care is a volunteer work for a charity or for another organisation, then it should not be considered for this variable.
- Care as a job should be excluded (this means that care done in a professional capacity is excluded). Persons who provide care as a job, even if it is only a few hours per week, should be coded “No” unless they care for people in their spare time as well.
- Persons who receive allowances to take care of disabled relatives should be considered as carers (codes 2 or 3).
- Children up to 14 who have a handicap, a disability or a health problem are considered as “children” (code 1, or 3 if also care of dependant adults takes place).

Note: Disabled persons who are obviously not able to take regularly care of others need not to be asked as this could be annoying for them. The respective coding '4' could be assigned automatically.

Col 198: Use of childcare services per week for the youngest child living in the household (including paid childminders, pre-school; apart from compulsory school).

- The variable addresses the standard situation outside holidays or other particular arrangements (e.g. emergency arrangements due to sick child or other problems).
- If the youngest child is a school-going child only services outside compulsory school hours are to be considered.
- Children aged 14 years old should be considered.
- Codes 1 to 5: Average total number of hours per week for all childcare services used during a typical week (omitting school holidays or emergency arrangements).
- Code 6: Generally, no childcare services are used. This includes situations where partners/relatives/neighbours/friends (unpaid) care for the child OR if children up to 14 always take care of themselves/each other OR if the person works at home/cares for the child at the work place OR if no childcare is used at all (e.g. compulsory school hours correspond to working hours).

Note: if a child (sister/brother) aged more than 14 takes care of the children up to 14, then no childcare services are used and the coding should be 6.

Note: for consistency reasons at household level father and mother should give the same answer. In a situation where both father and mother are available for a direct interview, it might be recommendable to ask only one of the two persons and to fill the variable CHILDCAR for the other person with the information already collected.

Note: countries should decide at national level on the use of different formulations for families with at least one younger and families with only older children, where the latter might not need normal childcare any more.

Col 199: Impact of availability and affordability of care facilities on not working or working part-time.

This variable extends the coverage of the core-variable NEEDCARE in the context of this module to further groups and is therefore defined in the same way as NEEDCARE.

The intention of IMPFACIL and NEEDCARE is the identification of (negative) impacts of missing suitable care facilities on the labour market participation. If it is considered to be more appropriate for the national implementation to add a positive code, for instance for respondents who decide to work part-time because of the availability of childcare, this is of course possible. For the transmission to Eurostat these answers should be coded as '4' – Care facilities do not influence decision for labour market participation. Positive codes of this kind might be added to NEEDCARE in the future after a review of the variable in the light of the 2010 ad hoc module results.

Col 200: Main reason (linked with childcare) for not working or working part-time.

- Code 1: this code should be used when the care is not available as needed. This means that there is no childcare service for the children in the area (accessible) at all (including: available services are too far away) OR no childcare service available (no place available / full ...) OR not enough care service for children who need more time of care (e.g. a child is cared for in the morning but lack of care services in the afternoon) OR the opening hours are in general not convenient. This code should therefore also be used if childcare services are available at normal times, e.g. approximately from 7h00 to 19h00, but the care would be needed at special times, that is to say approximately before 7h00 in the morning, at night, after 19h00 in the evening, during the weekend or during school holidays.
- Code 2: a person who is not working and who might expect a salary which is not high enough compared to the cost of the care should be coded here (the salary can be higher than the cost of the care but not high enough to encourage the person to work).
- Code 3: “quality not sufficient” from the person’s point of view includes educational contents not sufficient, too many children and not enough carers, person not confident (does not trust), ... Should also be used in case of lack of suitable childcare services for children (up to 14) with special needs.
- Code 4: This is a residual category and it applies only when the conditions in the cases 1 – 3 do not apply.

Col 201: Main reason (linked with care of other dependants) for not working or working part-time.

- Code 1: this code should be used when the care is not available as needed. This means that there is no care service for the person at all (including: available services are too far away) OR no care service available (no place available / full ...) OR not enough care (need of a prolongation of the care service) OR the opening hours are in general not convenient. This code should therefore also be used if care services are available at normal times, e.g. approximately from 7h00 to 19h00, but the care would be needed at special times, that is to say approximately before 7h00 in the morning, at night, after 19h00 in the evening, during the weekend, during holidays, 24 hours/24 hours.
- Code 2: too expensive for the person helped OR for the person who helps. A person who could expect a salary which is not high enough compared to the cost of the care he/she would have to support should be coded here (the salary can be higher than the cost of the care but not high enough to encourage the person to work).
- Code 3: “quality not sufficient” from the interviewed person’s point of view OR from the helped person’s point of view. Includes persons not confident (do not trust).
- Code 4: This is a residual category and it applies only when the conditions in the cases 1 – 3 do not apply.

Col 202: Variable working hours.

- Code 1: Fixed start and end are defined as a regular (not necessarily constant) long-term pattern of fixed daily working times without the possibility to start or end the working day later/earlier. All schemes which allow the employer but not the employee to vary the working hours should be coded 1 as well. In particular, shift work should be coded 1, even if the employee can change shifts, as the varying pattern is basically defined by the employer and not the employee. The same applies to annualised hours contracts.
- Code 2: Flexitime / working time banking is a system of accumulation and settlement of debit and credit hours around a standard number of weekly or monthly working hours. Over a longer period, the average number of working hours is equal to the number of contractually agreed working hours. Working time banking as an arrangement of total autonomy when to start and finish work.
- Code 3: This code covers the concept of staggered working hours, a situation where workers may start earlier and finish later outside a range of hours according to regulation or collective agreement when presence is compulsory. Contrary to flexitime / working time banking there are no account systems of credit and debit hours allowing employees to take time off. The number of hours worked each day is equal to the contractual number. Staggered working allows the normal working hours to be varied to suit an individual’s needs (as long as service needs/requirements are assured), whilst working the daily contracted hours for the post. Banded start/end, for instance working from 10am-6pm rather than 9am-5pm, is one special example of staggered working hours. This code also includes cases where the daily working hours can be considered as fixed, but in practice some flexibility regarding the daily working hours is given, and it is not controlled whether a person works exactly the daily number of hours. One example of this is work done mainly during office hours because at that time clients have to be served, but outside these hours some flexibility is given.
- Code 4: This code should be used if the employee can define his own work schedule without any formal boundaries.
- Code 5: This is a residual category and it applies only when the patterns described in codes 1 - 4 do not apply. One example is the frequent case of a fixed start of the day with a variable end, i.e. a worker has to work until the work is finished (no other category precisely matches this case). Another example is teachers for whom the teaching hours are defined, whereas the preparation and follow-up working hours can be organised by the teachers themselves. Other individual agreements which do not fit into one of the other categories should also be coded here.

Note: the order of codes reflects the expected frequency of occurrence. The order of increasing flexibility is 1, 3, 2 and 4. The coding should always reflect the maximum flexibility given, e.g. respondents with staggered working hours combined with a system of credit and debit hours should be coded as 2. Countries are of course free to use the order of flexibility in the questionnaires to highlight this.

Note: National Statistical Institutes should adapt the concepts described above further to the national situation if they consider this as necessary to get good results. They should in particular find descriptions of the different types of varying working time arrangements which are easily understandable for the respondents in their country. If certain arrangements listed do not exist in a country, this should be taken into account when designing the questionnaire in order not to confuse respondents.

Note: even if self-employed might face similar problems as employed, it would be too difficult to cover them. Many self-employed might also be annoyed or puzzled by questions on variable working hours.

Col 203: Possible to vary start and/or end of working day for family reasons (at least one hour).

- Code 1: the person can generally start later and/or finish earlier for family reasons (outside particular periods of urgent work ...).
- Code 2: the person can start later and/or finish earlier for family reasons, but rarely and not generally. This covers cases of emergencies.
- Code 3: the person can not start later and/or finish earlier for family reasons. Respondents for whom this question is not relevant because of their special workplace, e.g. oil-platform workers, should also be coded here.

Col 204: Possible to organise working time in order to take whole days off for family reasons (without using holidays).

- Code 1: the person can generally organise the working time in order to take whole days off for family reasons (outside particular periods of urgent work ...; even if a limit for the number of days exists). Persons who have the general possibility to organise their working time in order to take whole days off should be coded 1 because they can do it in particular for family reasons.
- Code 2: the person can organise the working time in order to take whole days off for family reasons, but rarely and not generally. This covers cases of emergencies.
- Code 3: this code applies to persons who can not organise the working time in order to take whole days off, e.g. teachers.

Col 205: Reduced working hours to take care of the youngest child in the household for at least one month (excluding maternity and paternity leave).

- Code 1: All forms of reduction of working hours on a daily or weekly basis are covered (for instance, persons taking every Monday off during two months using a parental leave). Standard holidays or flexitime systems (balance of overtime) are excluded if these are the only arrangements used. The reduction should however be relatively significant and regular, i.e. occur for at least one month (exceptional cases do not need to be surveyed). Arrangements of less than one month duration are not included. Special cases such as separated parents who alternately spend one week with their child (reducing working hours or not working at all) and work e.g. full-time the next week (when the separated partner cares for the child) should also be coded here in case this corresponds to a reduction of working hours as defined above.

The long reference period (child up to the 8th birthday living in the household) allows covering parental leave rights: replies are therefore not only expected from persons currently working, but also from persons unemployed or inactive who worked in the past. In case of multiple jobs, the reduction concerns any or all jobs (reduction of working hours in the main or second job only, total interruption of the second job and same patterns for the main job, etc.).

- Code 2: this code should also include the following cases:

- Persons on maternity or paternity leave,
- Persons having reduced their working time only using standard holidays or flexitime systems (balance of overtime).

Note: reductions of working time caused by temporary care absence should be included if they can be considered as regular reduction as defined above. It is not relevant whether the care absence is paid or unpaid. The only arrangements which are definitely excluded in REDWORK are those based entirely on standard holidays and flexitime compensation.

Col 206: Stopped working to take care of the youngest child in the household for at least one month (excluding maternity and paternity leave).

One month can also be defined as 4 consecutive weeks.

Persons who left their job (with or without fixed duration) and who stopped working or looking for a job in order to look after the youngest child are included.

Col 207: Full-time parental leave of at least one month taken to care for the youngest child in the household (excluding maternity and paternity leave).

The focus of PARLEAVE is on full-time parental leave for the youngest child. It might be combined with the variable STOPWORK for persons who are working or who worked after or shortly before the birth of the youngest child (cp the respective filter), but as parental leave entitlements are not in all Member States linked to employment, the filter of PARLEAVE is not restricted to these groups. However, the filter used during the interviews might be restricted to those employed or not employed with work experience (as in STOPWORK) if parental leave is strictly related to employment in a given country. For countries in which parental leave is not restricted to employment a similar approach is recommended: a split into two questions, namely one targeting the same group as STOPWORK and another one for the remainder of the persons to cover all other cases.

– Code 1: this code applies in particular to persons who never took any parental leave or who took only part-time parental leave. It should also include the following cases:

- Persons who never worked (in countries in which parental leave entitlements are linked to employment),
- Persons on maternity or paternity leave,
- Persons having interrupted their work entirely with standard holidays or flexitime systems (balance of overtime).

– Codes 2 to 6: the duration of the full-time parental leave should be relatively significant, i.e. at least one month in a block. Interruptions of less than one month, standard holidays or flexitime systems (balance of overtime) are excluded if these are the only arrangements used. However, the codes 2 to 6 would cover persons who took at least one month, combining fulltime parental leave with other arrangements, e.g. standard holidays or flexitime systems (balance of overtime), as it might be difficult for the respondent to distinguish all different concepts and periods exactly.

In case several parental leave periods of more than one month exist, in general the length of the longest period should be provided in line with the provisions for STOPWORK. However, the total duration of all periods of this kind can be provided if this gives a clearer picture of the situation of the respondent (cp. STOPWORK above). The parental leave take-up rate is not affected by this approach, and the results should be better comparable with STOPWORK as the same criteria are applied. In case of multiple jobs, the parental leave might concern one job only. The exact duration of the parental leave is not asked from persons who are still on full-time parental leave, as they might not know the date of its termination yet.

Specifications of the 2009 ad hoc module on the entry of young people into the labour market

| Column | Code | Description | Filter |
|---------------------|--|---|---|
| 203 (PARHAT) | 1 2 3 9 Blank | Highest level of education successfully completed by father or mother Low: ISCED 0, 1, 2 and 3c short Medium: ISCED 3-4 (without 3c short) High: ISCED 5-6 Not applicable (persons aged less than 15 or more than 34) No answer | Everybody aged 15-34 |
| 204-207 PARFOR | 9999 Blank | Country of birth of father and mother (For Germany: nationality/former nationality of father and mother when they have in the reference week the German nationality) For coding, see ISO country classification 4 digits (father - 2 first digits, mother - 2 last digits) Not applicable No answer | Everybody aged 15-34 |
| 208 HATVOC | 1 2 3 4 5 9 Blank | Orientation of the highest level of formal education attained (HATLEVEL) General education Vocational education mainly (or solely) school based Combination of school and work place based vocational education Vocational education mainly work place based Vocational education, with no distinction possible between 2, 3 and 4 Not applicable No answer | Everybody aged 15-34 and HATLEVEL=21-43 |
| 209-214 STOPDATE | ... 999999 Blank | Month and year of leaving formal education for the last time Month and year Not applicable No answer | Everybody aged 15-34 and EDUCSTAT=2 and HATLEVEL≠00 |
| 215 WORKEDUC | 0 1 2 3 4 5 6 7 9 Blank | Work during studies in formal education No work or work less than 1 month per year Work (only) as part of educational programme Work while studying but outside educational programmes Work (only) during an interruption of studies Work as combination of 1 and 2 Work as combination of 1 and 3 Work as combination of 2 and 3 Work as combination of 1, 2 and 3 Not applicable No answer | Everybody aged 15-34 |
| 216-221 JOBSTART | 000000 000001 999999 Blank | Month and year of start of the first job of more than 3 months after leaving formal education for the last time Never had a job of more than 3 months Current job is my first job Month and year Not applicable No answer | Col.209-214 ≠ 999999 and blank |
| 222-224 JOB DUR | ... 999 Blank | Duration of the first job of more than 3 months (after leaving formal education for the last time) Number of months Not applicable No answer | Col. 216-221 ≠ 000000 and 000001 and 999999 |
| 225 FINDMETH | 1 2 3 | Method which allowed to find the first job of more than 3 months (after leaving formal education for the last time) Via educational institution Via PES (Public Employment Services) Via ads in press or on the Internet | Col. 216-221 ≠ 000000 and 999999 |

Labour Force Survey - United Kingdom

| Column | Code | Description | Filter |
|--------------------|--|---|--|
| | 4 5 6 7 8 9 Blank | Submission of direct (spontaneous) job application to employer Via family and friends Job found after previous experience (summer/student job, apprenticeship, traineeship, voluntary job) in the same company Launching private business Other Not applicable No answer | |
| 226-229 JOB OCC | 9999 Blank | Occupation of the first job of more than 3 months (after leaving formal education for the last time) ISCO-88 (COM) coded at 3 or if possible 4 digits level Not applicable No answer | Col. 216-221 ≠ 000000 and 000001 and 999999 |
| 230 JOB CONTR | 1 2 3 4 5 6 9 Blank | Type of contract of the first job of more than 3 months (after leaving formal education for the last time) Self-employed Employee, permanent full-time Employee, permanent part-time Employee, temporary full-time Employee, temporary part-time Family worker Not applicable No answer | Col. 216-221 ≠ 000000 and 000001 and 999999 |
| 231 TRANSACT | 1 2 3 4 5 6 7 8 9 Blank | Main activity after leaving formal education for the last time and before starting the first job of a duration of at least 3 months Employed - work in job(s) of short duration (maximum 3 months) Compulsory military or community service Not employed, actively looking for the job Not employed, not looking actively for a job because of: Family responsibilities Participation in non-formal education Voluntary activities Health problems Other reasons Not applicable No answer | Col.209-214 ≠ 999999 and blank and {first job started more than 3 months after the date in Col.209-214 or Col.216-221 =000000} |
| 232/237 | 0000-9999 00-99 | Weighting factor for the LFS module 2009 (optional) Columns 232-235 contain whole numbers Columns 236-237 contain decimal places | Everybody aged 15-34 |
| 238 (PARFOR) | 9999 Blank | Nationality at birth of parents (optional) For coding, see ISO country classification Not applicable No answer | Everybody aged 15-34 |

Explanatory Notes for LFS 2009 ad hoc module

Col 203: Highest level of education successfully completed by father or mother

This variable will need two questions (about father and mother separately).

Parents:

- If the father and the mother belong to the household, the information on their highest level of education can be taken from the core LFS without asking the question.
- Response to this question should be spontaneous.

Labour Force Survey - United Kingdom

If interviewee asks about which parents (biological or not) should be considered, the interviewer should ask him firstly on those with whom the person grew up (e.g. step mother/father rather than biological one not living in the same household). This question can also concern other persons with whom the interviewee spent most childhood (e.g. grandparents).

In the case of doubts, parents could be defined as those living with the person around the age of 15 (the information on the educational level of parents should however correspond to the highest level achieved and not to the level achieved at the time the child was 15 years old). If the interviewee grew up with a single person, his/her educational level should be considered as "highest". People brought up in institutions should be coded blank.

- The level of education is coded according to the International Standard Classification of Education (ISCED 97). The NEACs (National Educational Attainment Classification) or other national classifications provide information about educational attainment according to the specific national situation. They constitute the basis for the recoding of national levels into the ISCED.
- At the European level, data on educational attainment of parents will only be coded according to three broad categories (low - medium - high). However, in the national questionnaires countries should collect the information at a sufficient level of detail in educational attainment that allows the allocation to the three categories, e.g. with regard to ISCED 3C short (less than 2 years of duration) which should be considered as low educational attainment.
- The expression "level successfully completed" must be associated with obtaining a certificate or a diploma, when there is a certification. Persons who have not completed their studies should be coded according to the highest level they have completed and should not be coded with a blank.

Col 204/207: Country of birth of father and mother

The first 2 digits correspond to the country of birth of the father and the 2 others to the country of birth of the mother. In the case of unknown country, code 00 for the mother or father should be used. The definition of parents should be the same as the one used in the previous variable.

This variable should be provided according to the coding given in Annex IV of the LFS explanatory notes (derived from ISO). If possible the exact country should be indicated; where this is not possible, one of the general groupings in bold print should be used. EU and EFTA Member States but also candidate and other European countries must be coded individually.

For the purpose of this question, current national boundaries should be considered, rather than any applying at the time of the respondent parents' birth. Some countries (those with colonial past or tradition of emigration) could add a variable on nationality at birth of parents with the aim to identify better foreign background of the young person: This variable is however optional.

Col 208: Orientation of the highest level of formal education attained (HATLEVEL)

This information will be collected only for persons with educational attainment at ISCED levels 2, 3 and 4.

Coding for this variable should be done together with the variables HATLEVEL and HATFIELD, using national classification of educational programmes, and preferably without asking any further questions.

The categories proposed are established according to the ISCED definitions applied in the UOE data collection and the VET (Vocational Education and Training) data collection as agreed by Member States (EUROSTAT/E3/2000/VET02, incl. a definition for VET).

1. General education: less than 25% of the programme content was vocational.
2. Vocational (and pre-vocational education): at least 25% of the programme content is vocational (specifically oriented towards a specific class of occupations or trades and leading to a labour-market relevant qualification).
 - *Vocational education and training mainly school-based*: at least 75% of the vocational education/training hours spent in a school, college or a training centre; the rest in a working environment (enterprise or other).

- *Vocational education and training mainly workplace based*: at least 75% of the vocational education/training hours spent in a working environment (enterprise or other); the rest in a school, college or a training centre.
- *Combination of school and workplace based vocational education and training* (e.g. dual system, alternate programmes): less than 75% of the vocational education/training hours spent in a school, college or a training centre, the rest in a working environment (enterprise or other) - remainder of the two above

If the information about the orientation of education can not be obtained directly from the list of programmes used for the variable HATLEVEL, indication done above on the criteria of distinction of different types of vocational education will be adopted to national situation with the aim to help the respondent. At least basic distinction between general and vocational education (code 1 versus 5) should be assured.

Col 209/214: Month and year of leaving formal education for the last time

"Leaving" means leaving studies in formal education for the last time before the interview, regardless of whether the programme was successfully completed or not and even though the interviewee can have the intention to return to education in the future ("interruption").

Due to the difficulties faced by some countries for the identification of the date of leaving formal education for the last time, bilateral contacts between National Statistical Institutes and Eurostat are strongly encouraged. Examples or remarks which might be of interest for other Member States are uploaded on the FAQ webpage in reference at the beginning of this document.

As this variable serves as a reference point and filter for the variables concerning the first job, it is very important to obtain this information and to reduce non-answers to minimum.

The first 2 digits should be used for the month and the 4 following digits for the year (example: 052005 corresponds to May 2005). In the case of unknown month, code 00 for the month should be used.

Col 215: Work during studies in formal education

The question should be asked to the persons who have already finished their formal education as well as to the current students. The whole period of studies should be taken into account (not only the last level of education).

"Work" means here a job for pay or profit, of a minimal duration of about 1 month per year, on average: this can be expressed as approximately 4 weeks full-time, 8 weeks part-time or 150 hours within a year (not as 1 month adding up all employment spells for the whole period of studies). The purpose being to avoid reporting on very minor jobs but without increasing the burden on respondents, a reference to at least one month for a given year would be acceptable.

Two main purposes justify this variable:

- to detect the 1st experience in the labour market (search for a job, schedules, pay..) which can have a positive impact on the entry into the labour market after the studies
- to distinguish the work performed as a part of the educational programmes completed (since this will not be possible for all countries via the variable HATVOC)

Code 1: "Work as part of educational programme" means that a workplace based element is a compulsory part of the curriculum, such as in apprenticeship or dual system programmes or compulsory internships. Working during school holidays should be coded 2.

Interruptions of studies should be those of at least one school/academic year.

Col 216/221: Month and year of start of the first job of more than 3 months after leaving formal education for the last time

Only jobs for pay or profit of more than 3 months should be taken into account. This job could have started before leaving education although it was still the first job after leaving education. In that case JOBSTART will be before STOPDATE. If the current job is a first job but of the duration of less than 3 months (counted in the reference week), code 000000 should be used. Apprenticeship/unpaid traineeship, compulsory military or community service and summer jobs should be excluded.

Labour Force Survey - United Kingdom

The first 2 digits should be used for the month and the 4 following digits for the year (ex: 052005 correspond to May 2005). In the case of unknown month code 00 for the month should be used.

Col 222/224: Duration of the first job of more than 3 months (after leaving formal education for the last time)

Only jobs for pay or profit of more than 3 months should be taken into account. This job could have started before leaving education although it was the first job after leaving education. In that case, the duration should be counted from JOBSTART. Apprenticeship/unpaid traineeship, compulsory military or community service and summer jobs should be excluded.

The question could be asked in terms of exact months first and in case of difficulties in time bands of 3 months could be proposed and the average point of the band could be provided.

Col 225: Method which allowed to find the first job of more than 3 months (after leaving formal education for the last time)

We are asking about the main successful method which allowed to find the first job.

Code 2 means that the person was informed of the existence of this first job by the Public Employment Services. The information can come directly or via the internet site of the PES.

Col 226/229: Occupation of the first job of more than 3 months (after leaving formal education for the last time)

The variable should be coded according to the ISCO 88-COM classification, at 3- or 4-(optional)-digits-level. For those countries that are not able to provide information at a 4 digit level the fourth digit should be coded '0'. We ask for the occupation when the first job started.

Col 230: Type of contract of the first job of more than 3 months (after leaving formal education for the last time)

Please see explanatory notes for the 2008 LFS explanatory notes for the variable STAPRO (professional status).

Employees with a temporary contract are employees whose main job will terminate either after a period fixed in advance, or after a period not known in advance, but nevertheless defined by objective criteria, such as the completion of an assignment or the period of absence of an employee temporarily replaced. In case that there was a probationary period when starting the job followed by a contract of unlimited duration, the job should nevertheless be reported as a permanent job.

This variable is about the type of the 1st contract, even it has changed after, but excluding probationary periods (see previous bullet). The distinction between full-time and part-time work should be made on the basis of a spontaneous answer given by the respondent.

Col 231: Main activity after leaving formal education for the last time and before starting the first job of a duration of at least 3 months

We are asking about the main activity. In case of various activities, respondent could choose the activity with the longest duration. Holidays after stopping education should be excluded (the question asks about the period after stopping formal education and after holidays if the person took them).

“Work” means a job for pay or profit. Unpaid apprenticeship should be included in "other reasons".

Col 232/237: Weighting factor

Columns 232/237 should be filled for the countries where the weighting factor for the LFS module 2009 is different to the weighting factor for the core LFS (e.g. proxies allowed in the core LFS but not for the module, specific non-response rate high for the module compared to the core LFS ...).

Col 238: Nationality at birth of father and mother (optional)

The first 2 digits correspond to the nationality of the father and the 2 others to the nationality of the mother. Nationality should be interpreted as citizenship. Citizenship is defined as the particular legal bond between an individual and his/her state acquired by birth or naturalisation, whether by declaration, option, marriage or other means according to national legislation. It corresponds to the country issuing the passport. The concept of nationality should not be mixed up with any concept of ethnic origin.

For persons with dual or multiple citizenships, and who hold the citizenship of the country of residence, that citizenship should be coded. In case of multiple citizenship, where it includes one citizenship of a member state of the European Union, that citizenship should be coded. In other situations the first answer of the respondent should be coded.

This variable should be provided according to the coding given in Annex IV of the LFS explanatory notes (derived from ISO). If possible the exact nationality should be indicated; where this is not possible, one of the general groupings in bold print should be used. EU and EFTA Member States but also candidate and other European countries must be coded individually.

Specifications of the 2008 ad hoc module on the labour market situation of migrants and their immediate descendants

| Column | Code | Description | Filter |
|---------|-------|---|---|
| 203/206 | | <i>Year of acquisition of citizenship</i> 4 digits | Everybody aged 15-74 and C17/18 = C170/171 |
| | 9996 | Year unknown but national by acquisition | |
| | 9997 | National at birth | |
| | 9998 | National since the creation of the country/redefinition of borders | |
| | 9999 | Not applicable (person aged under 15 or over 74 or (person aged 15-74 and C17/18 ≠ C170/171)) | |
| | Blank | No answer | |
| 207/208 | | <i>Country of birth of father</i> <i>(For Germany: nationality/former nationality of father when he has in the reference week the German nationality)</i> For coding see ISO classification | Everybody aged 15-74 |
| | 98 | Country unknown but father born abroad | |
| | 99 | Not applicable (person aged under 15 or over 74) | |
| | blank | No answer | |
| 209/210 | | <i>Country of birth of mother</i> <i>(For Germany: nationality/former nationality of father when he has in the reference week the German nationality)</i> For coding see ISO classification | Everybody aged 15-74 |
| | 98 | Country unknown but father born abroad | |
| | 99 | Not applicable (person aged under 15 or over 74) | |
| | blank | No answer | |
| 211/212 | | <i>Total number of years of residence in host country</i> | Everybody aged 15-74 and C19/20 ≠ 00 |
| | 01-98 | 2 digits | |
| | 99 | Not applicable (person aged under 15 or over 74 and C19/20 = 00)) | |
| | Blank | No answer | |
| 213 | | <i>Main reason the person had for migrating (last migration)</i> | Everybody aged 15-74 and C19/20 ≠ 00 and (C162/165 – C11/14 – C19/20) ≥ 15 |
| | 1 | Employment, intra-corporate transfer | |
| | 2 | Employment, job found before migrating other than code 1 | |
| | 3 | Employment, no job found before migrating | |
| | 4 | Study | |
| | 5 | International protection | |
| | 6 | Accompanying family/family reunification | |
| | 7 | Family formation | |
| | 8 | Other | |
| | 9 | Not applicable (person aged under 15 or over 74 or (person aged 15-74 and C19/20 = 00) or (person aged 15-74 and C19/20 ≠ 00 and (C162/165 – C11/14 – C19/20) < 15)) | |
| | Blank | No answer | |
| 214 | | <i>Whether the duration of the current residence permit/visa/certificate is limited (optional for France)</i> | Everybody aged 15-74 and C17/18 ≠ C170/171 |
| | 0 | Yes, less than 1 year | |

Labour Force Survey - United Kingdom

| Column | Code | Description | Filter |
|--------|-------|--|---|
| | 1-5 | Yes, number of years | |
| | 6 | Yes, limited duration of more than 5 years | |
| | 7 | Yes, but do not know the duration | |
| | 8 | No | |
| | 9 | Not applicable (person aged under 15 or over 74 or (person aged 15-74 and C17/18 = C170/171)) | |
| | Blank | No answer | |
| 215 | | <i>Whether current legal access to the labour market is restricted</i> | Everybody aged 15-74 and C17/18 ≠, C170/171 and (C24 = 1, 2 or C99 = 1, 2, 4 or (C99 = 3 and C116 = 1)) |
| | 1 | Yes, access restricted to employment for specific employers/sectors/occupations | |
| | 2 | Yes, access restricted to self-employment | |
| | 3 | Yes, access not allowing self-employment | |
| | 4 | Yes, combination of 1 and 2 | |
| | 5 | Yes, combination of 1 and 3 | |
| | 6 | Yes, combination of 1 and 3 | |
| | 7 | No | |
| | 8 | Does not know | |
| | 9 | Not applicable (person aged under 15 or over 74 or (person aged 15-74 and C17/18 = C170/171) or (person aged 15-74 and C17/18 ≠ C170/171 and C116 = 2, blank)) | |
| | Blank | No answer | |
| 216 | | <i>Use of facilities for establishing what highest qualification equates to in the host country system</i> | Everybody aged 15-74 and C19/20 ≠ 00 and (C24 = 1, 2 or C99 = 1, 2, 4 or (C99 = 3 and C116 = 1)) |
| | 1 | Yes, established what qualification equates to | |
| | 2 | Yes, but not established what qualification equates to or procedure not yet completed | |
| | 3 | No, no need because highest qualification obtained in the host country | |
| | 4 | No, no need for reason other than code 3 | |
| | 5 | No for other reason | |
| | 9 | Not applicable (person aged under 15 or over 74 or (person aged 15-74 and C19/20 = 00) or (person aged 15-74 and C19/20 ≠ 00 and C116 = 2, blank)) | |
| | Blank | No answer | |
| 217 | | <i>Need to improve host country language skills to get an appropriate job</i> | Everybody aged 15-74 and C19/20 ≠ 00 and (C24 = 1, 2 or C99 = 1, 2, 4 or (C99 = 3 and C116 = 1)) |
| | 1 | Yes | |
| | 2 | No | |
| | 9 | Not applicable (person aged under 15 or over 74 or (person aged 15-74 and C19/20 = 00) or (person aged 15-74 and C19/20 ≠ 00 and C116 = 2, blank)) | |
| | Blank | No answer | |
| 218 | | <i>Main help received in the host country in finding the current job or setting up own business</i> | Everybody aged 15-74 and C24 = 1, 2 |
| | 1 | Relatives/friends | |
| | 2 | Public employment office | |
| | 3 | Private employment agencies | |
| | 4 | Migrant or ethnic organisation | |
| | 5 | Other | |
| | 6 | None | |
| | 9 | Not applicable (person aged under 15 or over 74 or (person aged 15-74 and C24 = 3, 4, 5)) | |
| | Blank | No answer | |

Labour Force Survey - United Kingdom

| Column | Code | Description | Filter |
|---------|-------------|---|--|
| 219/220 | | <i>Use of services for labour market integration in the two years following the last arrival</i> | Everybody aged 15-74 and C19/20 ≠ 00 and C19/20 ≤ 10 and (C162/165 – C11/14 – C19/20) ≥ 15 |
| | 01 | Yes, contact with an adviser for job guidance/counselling or job search assistance | |
| | 02 | Yes, participation to labour market training/programmes | |
| | 03 | Yes, participation to host country language tuition | |
| | 04 | Yes, combination of 1 and 2 | |
| | 05 | Yes, combination of 1 and 3 | |
| | 06 | Yes, combination of 2 and 3 | |
| | 07 | Yes, combination of 1, 2 and 3 | |
| | 08 | No, not entitled to | |
| | 09 | No, for reason other than code 8 | |
| | 99 | Not applicable (person aged under 15 or over 74 or (person aged 15-74 and C19/20 = 00) or (person aged 15-74 and C19/20 ≠ 00 and C19/20 > 10) or (person aged 15-74 and C19/20 ≠ 00 and C19/20 ≤ 10 and (C162/165 – C11/14 – C19/20) < 15)) | |
| | Blank | No answer | |
| 221/226 | | <i>Weighting factor for the 2008 LFS module (optional)</i> | Everybody aged 15-74 |
| | 0000 - 9999 | Columns 220-223 contain whole numbers | |
| | 00 - 99 | Columns 224-226 contain decimal places | |

Explanatory notes for LFS 2008 ad hoc module

Col 203/206: Year of citizenship acquisition

Citizenship is defined as the particular legal bond between an individual and his/her State, acquired by birth or naturalization, whether by declaration, option, marriage or other means according to the national legislation. Reference should always be made to existing citizenships.

Code 9998: expected in case of break-up of countries, redefinition of borders ...

About dual citizenship: This variable aims to know only about the citizenship of the host country. In case a migrant has a foreign citizenship but also acquired the citizenship of the host country, then the year of citizenship acquisition should be filled. In case a person had a dual citizenship at birth -a foreign and the host country citizenship-, then code 9997 (national at birth) applies.

Note: "National/non national" and "citizen/non citizen" of the host country have exactly the same meaning (legal aspect).

Col 207/208 and Col 209/210: Country of birth of father and mother

Information on the country of birth of parents (father and mother) should be asked for following the same indications given in the core LFS for the variable *Country of birth*. Current borders apply.

For coding, see Annex IV of the LFS explanatory notes. The coding to be used for columns 207/208 and 209/210 shall be the same as for columns 17/18, 21/22, 39/40 and 150/151 of the core LFS (Annex II to Commission Regulation (EC) No 430/2005).

Reference should be made to legal parents. In case of adoption, this recommendation would favour the parents of adoption. Indeed, adopted children are brought up in the host country and live in a family with "native" culture and traditions (perspective of integration).

Col 211/212: Total number of years of residence in the host country

Labour Force Survey - United Kingdom

Years during which person had residence (taking up residence, establishment) in the host country should be taken into account. For example, short visits for tourism or to see family should be excluded.

For persons with up to one year's residence in total in this Member State, 01 should be coded; between one year and two years, 02; ... (may be revised – see PL comment).

Only interruptions of residence of more than one year should be considered as an exit of the host country.

E.g.

* a person took up residence for 6 months and then went back to his/her country for 2 years and then took up residence again in the host country 2 years ago: the total duration is 2 ½ years and should be coded '03'.

* a person took up residence for 6 months and then went back to his/her country for 9 months and then took up residence again in the host country 5 years ago: the total duration is 6 years and 3 months and should be coded '07'.

Control of the data: C19/20 <= C211/212. In case the last arrival in order to take up residence is also the first one, the same code should be used for C19/20 and C211/212.

Col 213: Reason the person mostly had for migrating (last migration)

Main reason for migrating for the last migration (the most recent) should be recorded.

The individual reason that the person interviewed had for migrating is requested. Different reasons in the same household are expected (e.g. father = employment, mother and child = family).

In case where multiple reasons apply, the main reason should be recorded (spontaneous choice from the person interviewed). The main reason for migrating at the moment of the migration should be recorded.

'Real' reason for migrating (i.e. the one declared by respondents) should be asked for (and not legal reason). All response options should be shown/read out to the interviewed persons for a better harmonisation of the data collected.

Codes 1, 2 and 3: Entering the country with or without any job perspective has probably not the same impact on the labour market integration. It is important to have this information separately.

Code 3: Including search for job and including persons who intended to set up own business.

Code 4: Including trainees, apprentices, interns.

Code 5: "Forced" migration - Humanitarian migration, including political refugees, asylum seekers, other populations under protection (1951 Geneva Convention on refugee status; Other forms of international protection -temporarily protected, persons in asylum procedure etc.).

Code 6: It includes accompanying family (e.g. spouse/children) of an entering worker/student, entry of spouse and/or children of a resident. Nuclear family (parents, dependant children) is taken into account as well as other dependant parents and dependant close children relatives (the main criteria is the dependency criteria).

Code 7: Family formation, creation (marriage).

Code 8: "Other" should refer to other voluntary migration. E.g. retired persons who came in the host country for their retirement, migrations for the climate, for health reasons, for better medical or health services, less insecurity (outside code 5), "housing" reasons for frontier-worker migrants...

Col 214: Whether the duration of the current resident permit/visa/certificate is limited

Codes 1 to 6 are of most interest.

Any kind of authorisation issued by the authorities of a Member State allowing to stay legally in its territory should be taken into account (e.g. residence permit/visa/certificate). Visas often refer to short duration (normally less than 3 months but can be less than 1 year).

The duration refers to the total duration of the authorisation (total length of validity) and not to the duration which is still valid. In case of successive permits, the duration of the current permit should be taken into account.

Coding for situations where residence permits are formally limited but automatically prolonged: the formal situation (limitation) should be taken into account.

EU citizens are often allowed to stay in the MS for unlimited duration (sometimes with the establishment of a certificate). Code 7 should apply in these cases.

Countries should be able to filter out nationals of countries that are free to live in the host country without authorisation for unlimited durations. These cases should be coded 7.

When designing the questionnaire, special care has to be taken due to the sensitivity of the topic.

No recommendation is made at the European level concerning the coding of illegal migrants because of the sensitivity of this issue in some countries. Codes 1 to 6 are of most interest, the MS are free to leave the coding of illegal migrants as their legal statistical rules allow them.

Col 215: Whether current legal access to the labour market is restricted

Codes 1 to 5 have priority on code 6 'Other legal access restrictions'.

Code 6 includes any other kinds of legal restrictions not included in codes 1 to 5 (e.g. geographical restrictions, no access ...), except time restrictions (see C214).

The MS have the possibility to build this variable using information from the core LFS, when feasible and when information is available. E.g. national rules on migrants' legal access to the labour market may be specific for some kinds of population that may be identified using variables from the core LFS. The use of administrative data is also possible to the extent that information can be linked with LFS data.

When designing the questionnaire, special care has to be taken due to the sensitivity of the topic.

No recommendation is made at the European level concerning the coding of illegal migrants or legal migrants working illegally because of the sensitivity of this issue in some countries. The MS are free to leave the coding as their legal statistical rules allow them.

Col 216: Use of means for establishing what highest qualification equates to in the host country system

"Use of means": all national or international reputable providers of certificates clarifying what qualifications (obtained abroad) equate to in the host country system should be taken into account. E.g. national authorities, professional or university bodies, NARIC (National Academic Recognition Information Centre) ... Such procedures are included whether they are free or not.

"Qualification": including educational qualifications and professional qualifications (vocational/training) - as in the ISCED system.

Code 1: persons obtained a certificate/document establishing what qualification equates to in the host country system.

Code 4: e.g. person does not need such a certificate for the work he/she does/wishes to do ...

Code 5: e.g. person was not aware of any such possibility, person thought it is too complicated, procedure too expensive or time consuming ...

Col 217: Need to improve host country language skills to get an appropriate job

All host nation languages should be taken into account as well as other co-official languages.

Time dimension: current situation applies.

"Appropriate job": type of job person would normally do/search for if language skills were not an issue (i.e. more in line with their qualifications/skills/previous work experiences).

"Need": the need should be the focus and not the willingness.

Code 2 includes:

* Cases where persons' abilities in host country language(s) are good

* Cases where persons' abilities in host country language(s) are not good but where it is not a problem because his/her job is appropriate, or their language skills would, in their view, not affect their ability to get an appropriate job.

Col 218: Main help received in the host country in finding the current job or setting up own business

Codes 1 to 5:

* Should only be recorded help provided by persons living/organisations set up IN the host country. E.g. migrants helped by relatives living in the country of origin should be coded 6.

* Migrants that were helped by persons/organisations of the host country but before they arrived in the host country should be included. E.g. a migrant who found his job in the host country before migrating thanks to a relative living in the host country.

Code 6 includes:

* Cases where persons were helped by persons/organisations in the country of origin

* Cases where persons were not helped at all (including those who didn't need any help)

Public employment office: including private organisations mandated by public employment office.

'Other': e.g. employers, business contacts, commune ...

Col 219: Use of services for labour market integration in the 2 years following the last arrival

"Participation to labour market training/programmes": including work experience schemes, professional training programmes/integration programmes. Training programmes/measures to assist integration in labour market, including that specific to helping migrants adapt to the labour market in the host country (e.g. participation in work experience schemes, vocational training).

"Participation to host country language tuition": reading/writing/speaking/understanding.

Public and private services should be included. E.g. services provided by public employment office or by other public services, services provided by associations, employers, Trade Unions ...

"Use of services for labour market integration": e.g. students who were in school without having used services for labour market integration are excluded from codes 1 to 7.

Code 8 'No, not entitled to': means no due to legal barriers.

Col 220/225: Weighting factor for the LFS module 2008

Columns 220/225 should be filled for the countries where the weighting factor for the LFS module 2008 is different to the weighting factor for the core LFS (e.g. proxies allowed in the core LFS but not for the module, specific non-response rate high for the module compared to the core LFS ...).

**Section 9:
EUROSTAT DERIVED VARIABLE FLOWCHARTS**

In order to meet EuroStat regulations described earlier, the UK LFS dataset is delivered to agreed specification. The EuroStat variables are derived from the domestic LFS variables. This section explains how the EuroStat variables are derived using flow charts. Other LFS User Guides that are related to the EuroStat variables can be found at: www.statistics.gov.uk/StatBase/Product.asp?vlnk=1537&Pos=1&ColRank=2&Rank=272

| Column | Description |
|---------------|--|
| 1/2 | Sequence number within household |
| 3 | Relationship to reference person in the household |
| 4/5 | Sequence number of spouse or cohabiting partner |
| 6/7 | Sequence number of father |
| 8/9 | Sequence number of mother |
| 10 | Sex |
| 11/14 | Year of birth |
| 15 | Date of birth in relation to end of reference week |
| 16 | Marital Status |
| 17/18 | Nationality |
| 19/20 | Years of residence in this country |
| 21/22 | Country of birth |
| 23 | Nature of participation in survey |
| 24 | Labour status during reference week |
| 25/26 | Reason for not having worked at all though having a job |
| 27 | Professional status |
| 28 | Continuing receipt of wage or salary |
| 29/31 | Economic activity of the local unit |
| 32/35 | Occupation |
| 36 | Supervisory responsibilities |
| 37/38 | Number of persons working at local unit |
| 39/40 | Country of place of work |
| 41/42 | Region of place of work (NUTS2) |
| 43/46 | Year which person started working for employer or self-employed |
| 47/48 | Month started with current employer or self-employed |
| 49 | Involvement of public employment office in finding present job |
| 50 | Full-time/part-time distinction |
| 51 | Reasons for the part-time work |
| 52 | Permanency of first job |
| 53 | Reasons for having temporary job/work contract of limited duration |
| 54 | Total duration of temporary job or work contract of limited duration |
| 55 | Contract with a temporary employment agency |
| 56 | Shift work |
| 57 | Evening work |
| 58 | Night work |
| 59 | Saturday work |
| 60 | Sunday work |
| 61/62 | Number of hours per week usually worked in the main job |

| Variable | Description |
|-----------------|---|
| 63/64 | Number of hours actually worked during reference week in the main job |
| 65/66 | Paid overtime in reference week in the main job |
| 67/68 | Unpaid overtime in reference week in the main job |
| 69/70 | Main reason hours actually worked differed from usual hours worked |
| 71 | Willingness to work more hours |
| 72 | Way that a person can work more hours |
| 73/74 | Number of hours would like to work in total |
| 75 | Working at home |
| 76 | Looking for another job |
| 77 | Main reason for looking for another job |
| 78 | Existence of more than one job or business |
| 79 | Professional status in second job |
| 80/81 | Economic activity of the establishment in second job |
| 82/83 | Number of hours actually worked during reference week in second job |
| 84 | Previous employment experience |
| 85/88 | Year in which person last worked |
| 89/90 | Month in which person last worked |
| 91/92 | Main reason for leaving last job or business |
| 93 | Professional status in last job |
| 94/95 | Economic activity of the local unit in last job |
| 96/98 | Previous job occupation |
| 99 | Seeking employment during previous four weeks |
| 100 | Reasons for not seeking employment |
| 101 | Type of employment sought (or found) |
| 102 | Duration of search for employment |
| 103 | Contacted public employment office to find work |
| 104 | Contacted private employment office to find work |
| 105 | Applied to employers directly |
| 106 | Asked friends, relatives, trade unions etc. |
| 107 | Inserted or answered adverts in newspapers or journals |
| 108 | Studied adverts in newspapers or journals |
| 109 | Took a test, interview or examination |
| 110 | Looked for land, premises or equipment |
| 111 | Looked for permits, licenses or financial resources |
| 112 | Awaiting results of job application |
| 113 | Waiting for a call from a public employment office |
| 114 | Awaiting results of a competition for recruitment to public sector |
| 115 | Other job search method used |
| 116 | Willingness to work for persons not seeking employment |
| 117 | Availability to start work within two weeks |
| 118 | Reasons for not being available to start work within two weeks |
| 119 | Situation immediately before seeking work |
| 120 | Need for care facilities |
| 121 | Registration at a public employment office |
| 122 | Main status |
| 123 | Student or apprentice in regular education during last 4 weeks |

| Variable | Description |
|-----------------|---|
| 124 | Level of the current education or training |
| 125/127 | Field of this education or training |
| 128 | Attendance at taught learning activities in last four weeks |
| 129/131 | Number of hours spent on all taught learning activities within last four week |
| 132 | Purpose of the most recent taught learning activity |
| 133/135 | Field of the most recent taught learning activity |
| 136 | Whether the most recent taught learning activity took place during paid working hours |
| 137/138 | Highest level of education or training successfully completed |
| 139/141 | Field of highest level of education or training successfully completed |
| 142/145 | Year when highest level of education or training successfully completed |
| 146 | Situation with regard to economic activity one year ago |
| 147 | Professional status one year ago |
| 148/149 | Economic activity of the local unit which person was working one year ago |
| 150/151 | Country of residence one year before survey |
| 152/153 | Region of residence one year ago (NUTS2) |
| 154/155 | Monthly (take home) pay from main job |
| 156/159 | Year of survey |
| 160/161 | Reference week |
| 162/163 | Interview week |
| 164/165 | Country |
| 166/167 | Region of household (using NUT2) |
| 168 | Degree of urbanisation |
| 169/174 | Serial number of household |
| 175 | Type of household |
| 176 | Type of institution |
| 177/182 | Yearly weighting factor |
| 183/188 | Quarterly weighting factor |
| 189/194 | Household yearly weighting factor |
| 195 | Sequence number of the survey wave |
| 196 | Questionnaire used |

HHSEQNUM (EPERSNO): Sequence number within household

Columns 1/2
PAGE 1 OF 1

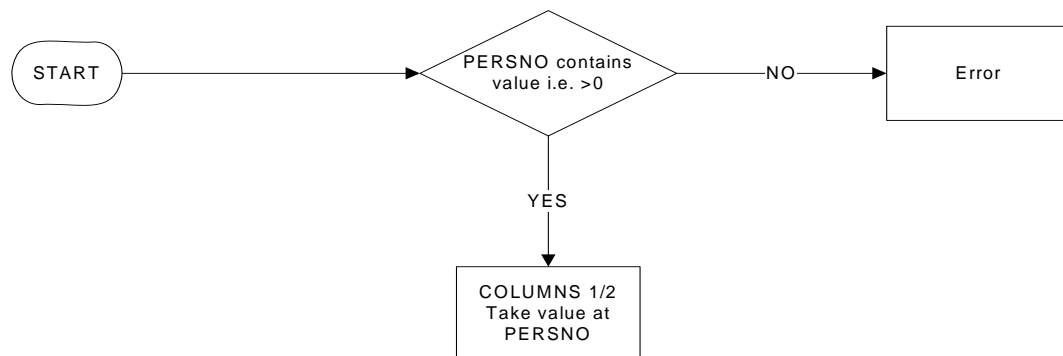

| | |
|------------|---|
| KEY | |
| 01 - 98 | Two-digit sequence number allocated to each member of the household |

HHLINK (ERELHOH): Relationship to reference person in the household

Column 3

PAGE 1 OF 2

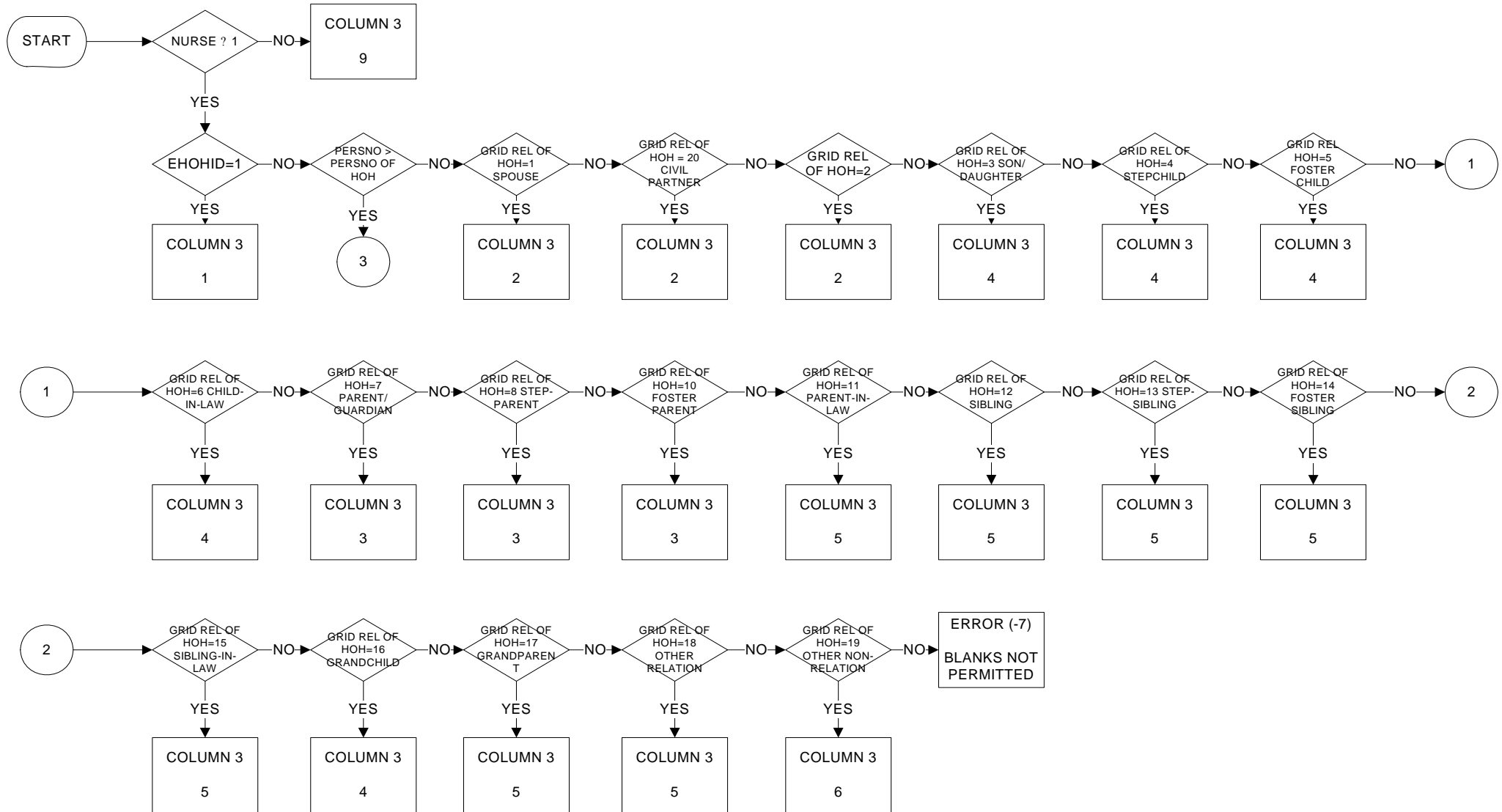

HHLINK (ERELHOH): Relationship to reference person in the household

Column 3

PAGE 2 OF 2

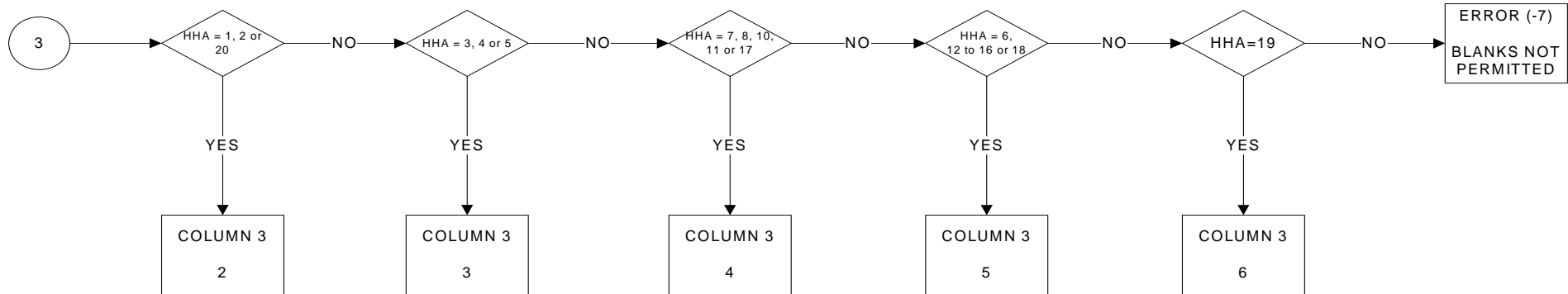

| KEY | |
|-----|---|
| 1 | Reference person |
| 2 | Spouse (or cohabiting partner) of reference person |
| 3 | Child of reference person (or of his/her spouse or cohabiting partner) |
| 4 | Ascendent relative of reference person (or of his/her spouse or cohabiting partner) |
| 5 | Other relative |
| 6 | Other |
| 9 | Not applicable (HHTYPE ? 1, 3) |

HHSPOU (ESPOUSE): Sequence number of spouse or partner

Columns 4/5

PAGE 1 OF 2

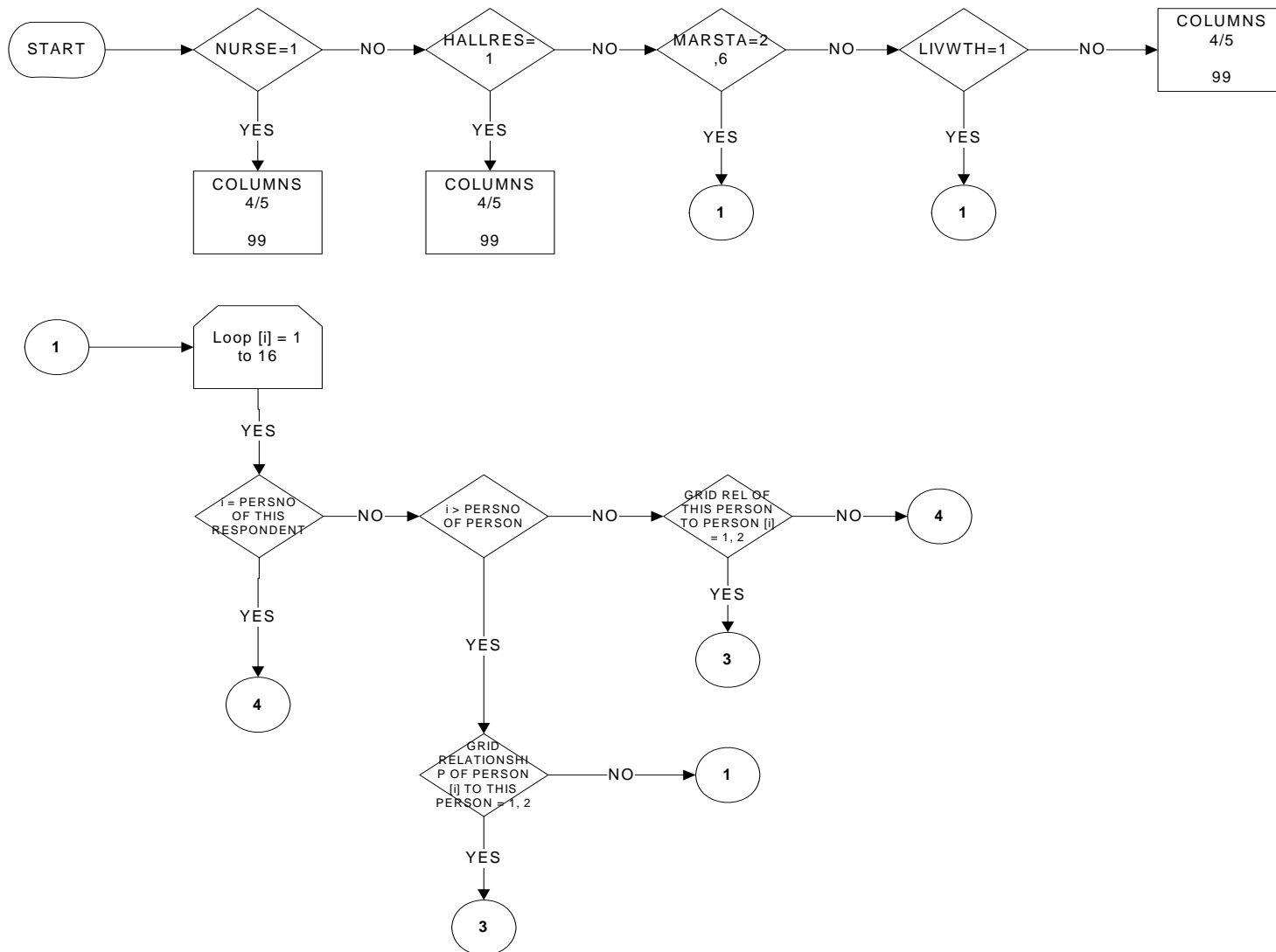

HHSPOU (ESPOUSE): Sequence number of spouse or partner

Columns 4/5
PAGE 2 OF 2

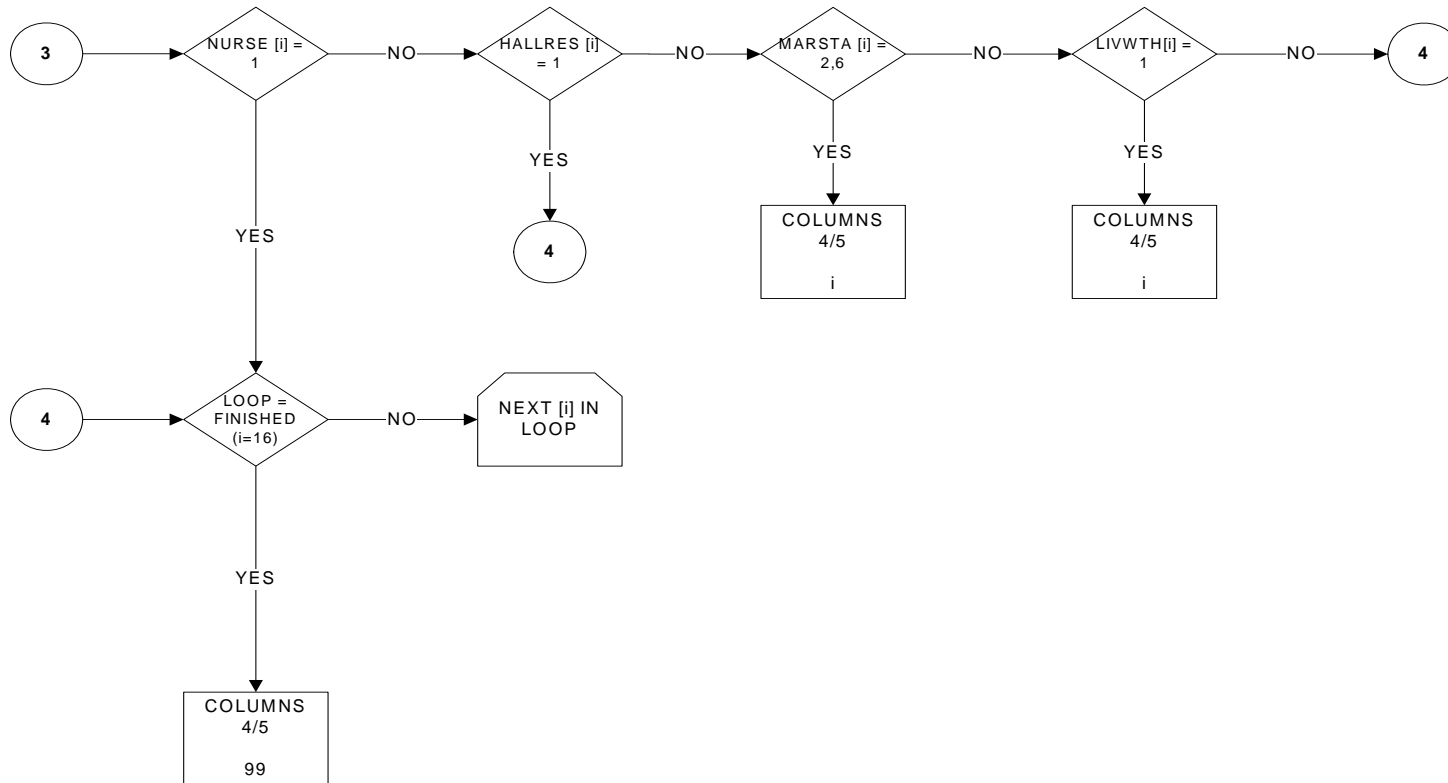

| KEY | |
|-------|---|
| 01-98 | Sequence number of spouse or cohabiting partner in the household |
| 99 | Not applicable (person does not belong to a private household, or has no partner, or the partner does not belong to this private household) |

HHFATH (EFATHER): Sequence number of father

Columns 6/7

PAGE 1 OF 1

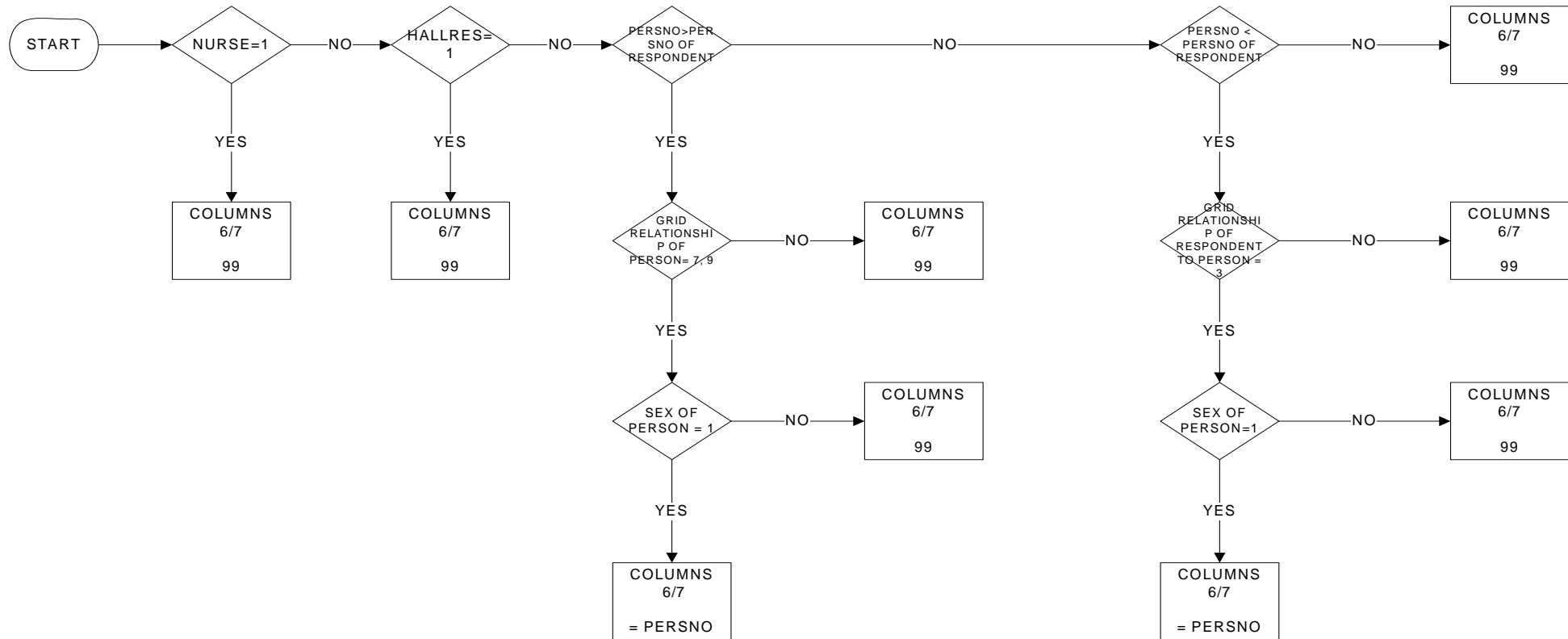

| KEY | |
|---------|---|
| 01 - 98 | Sequence number of father in the household |
| 99 | Not applicable (person does not belong to a private household, or the father does not belong to this private household) |

HHMOTH (EMOTHER): Sequence number of mother

Columns 8/9
PAGE 1 OF 1

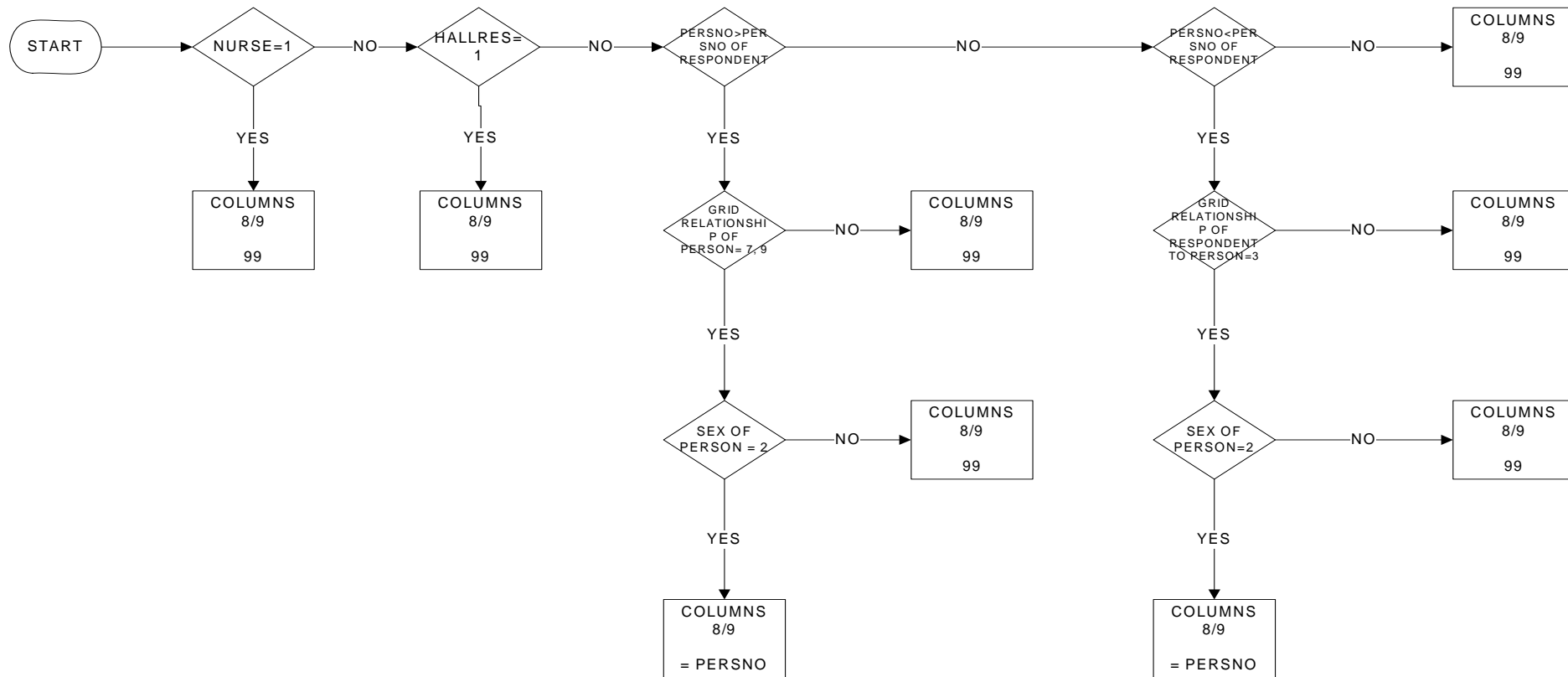

| KEY | |
|---------|---|
| 01 - 98 | Sequence number of mother in the household |
| 99 | Not applicable (person does not belong to a private household, or the mother does not belong to this private household) |

SEX (ESEX): Sex
Column 10
PAGE 1 OF 1

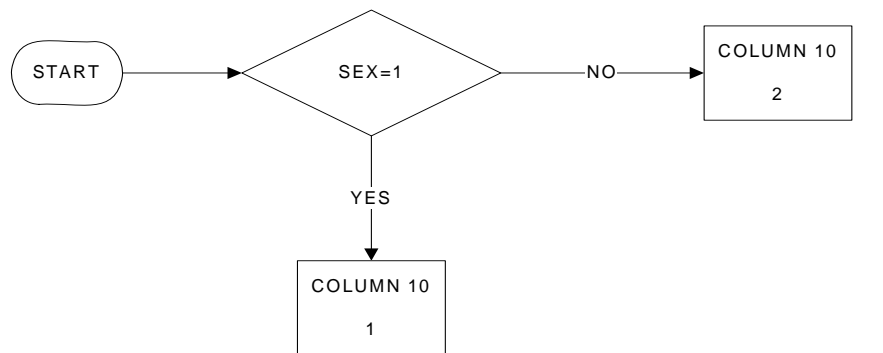

| KEY | |
|-----|--------|
| 1 | Male |
| 2 | Female |

YEARBIR (EYOB): Year of birth

Column 11/14

PAGE 1 OF 1

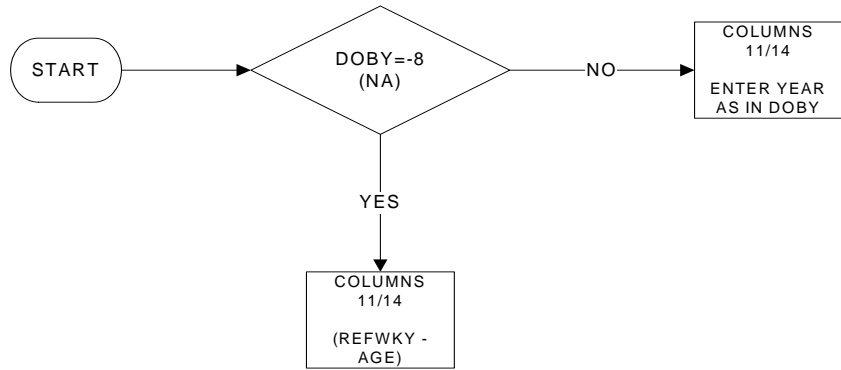

Notes:

The 4 digits of year of birth are entered

DATEBIR (EDOB): Date of birth in relation to end of reference week

Column 15

PAGE 1 OF 1

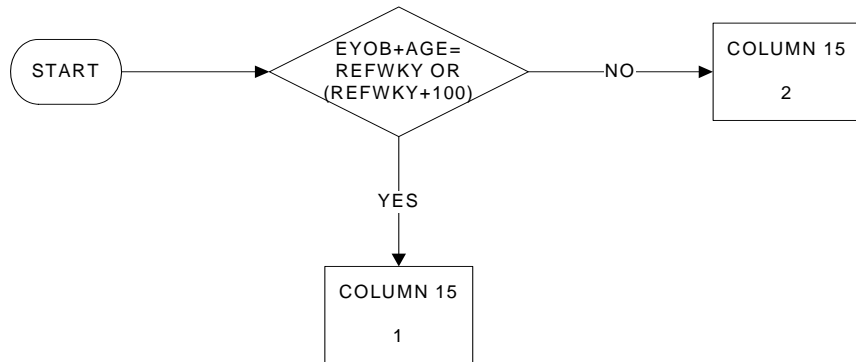

KEY

- 1 Person's birthday falls between 1 January and the end of the reference week.
- 2 Person's birthday falls after the end of the reference week.

Notes

Derive EYOB first

MARSTAT (EMARSTAT): Marital Status

Column 16

PAGE 1 OF 1

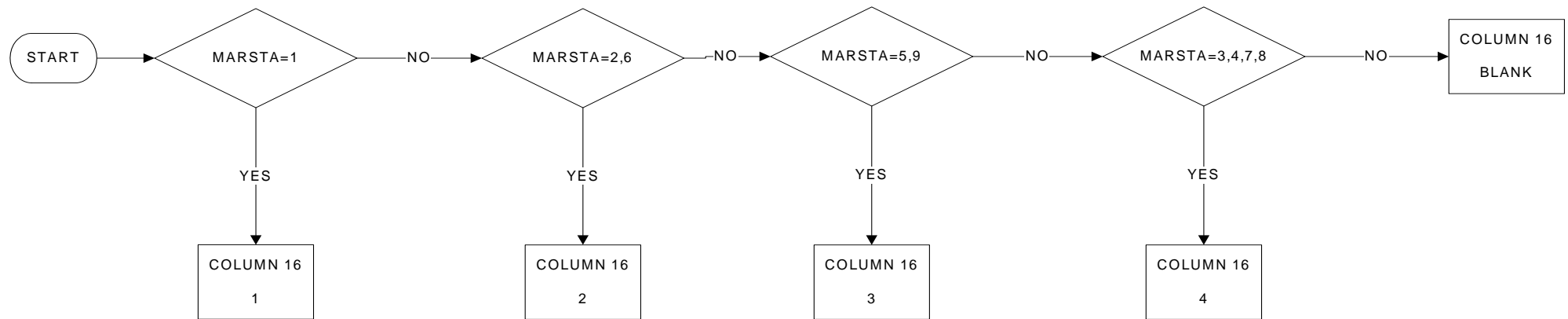

| KEY | |
|-------|-------------------------------|
| 1 | Single |
| 2 | Married |
| 3 | Widowed |
| 4 | Divorced or legally separated |
| Blank | No answer |

NATIONAL (ENAT): Nationality

Columns 17/18

PAGE 1 OF 7

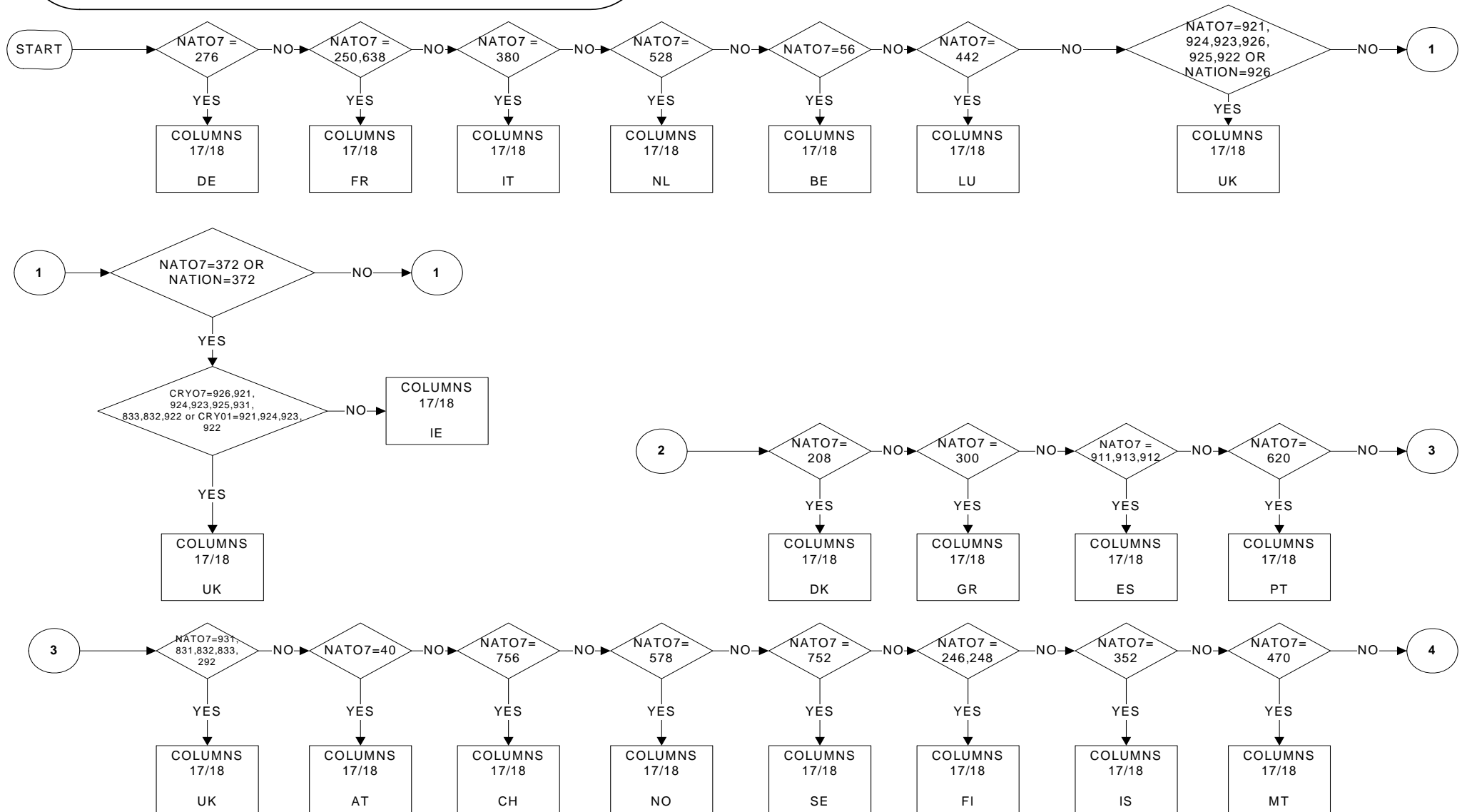

NATIONAL (ENAT): Nationality

Columns 17/18

PAGE 2 OF 7

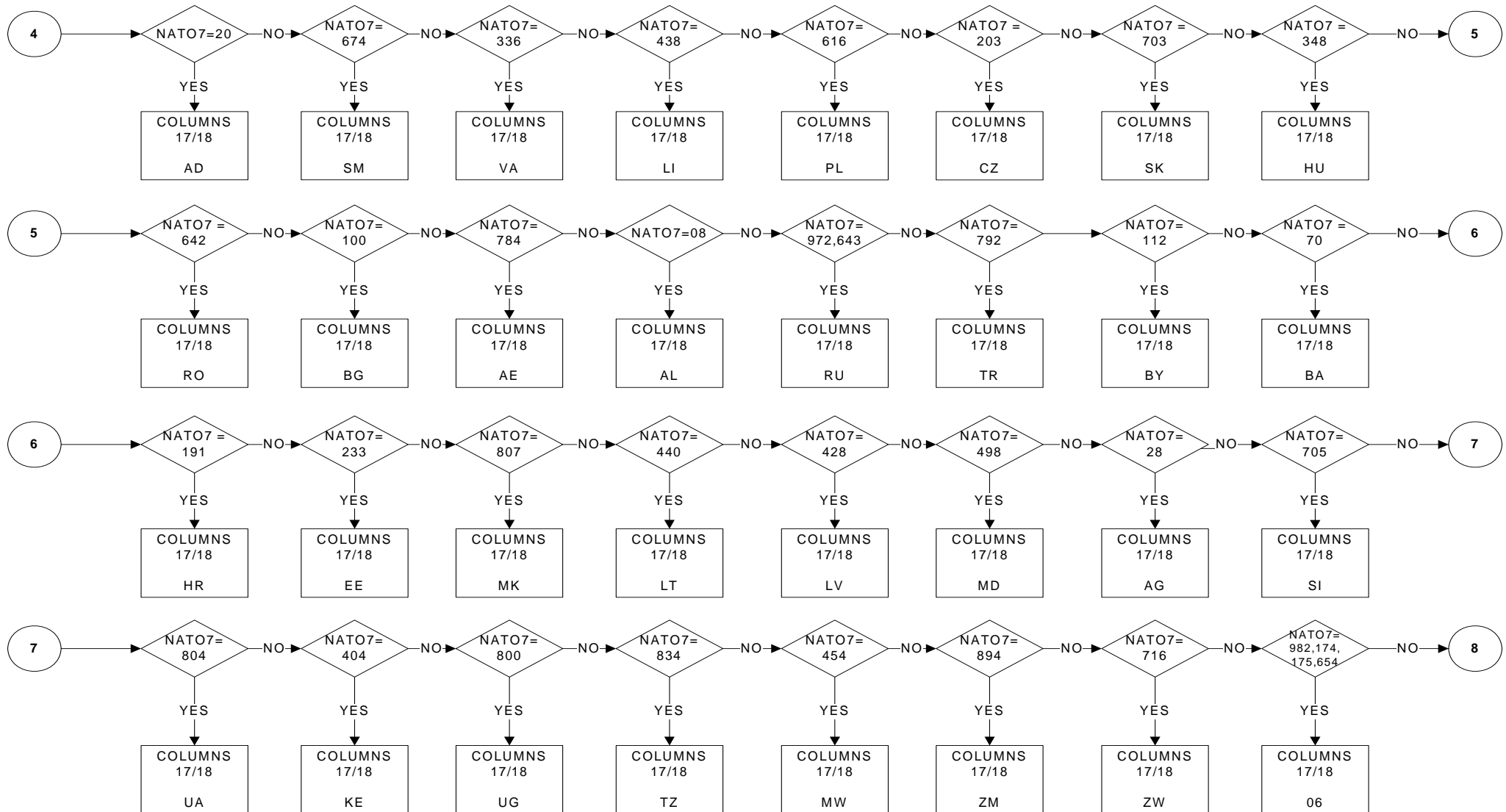

NATIONAL (ENAT): Nationality

Columns 17/18

PAGE 3 OF 7

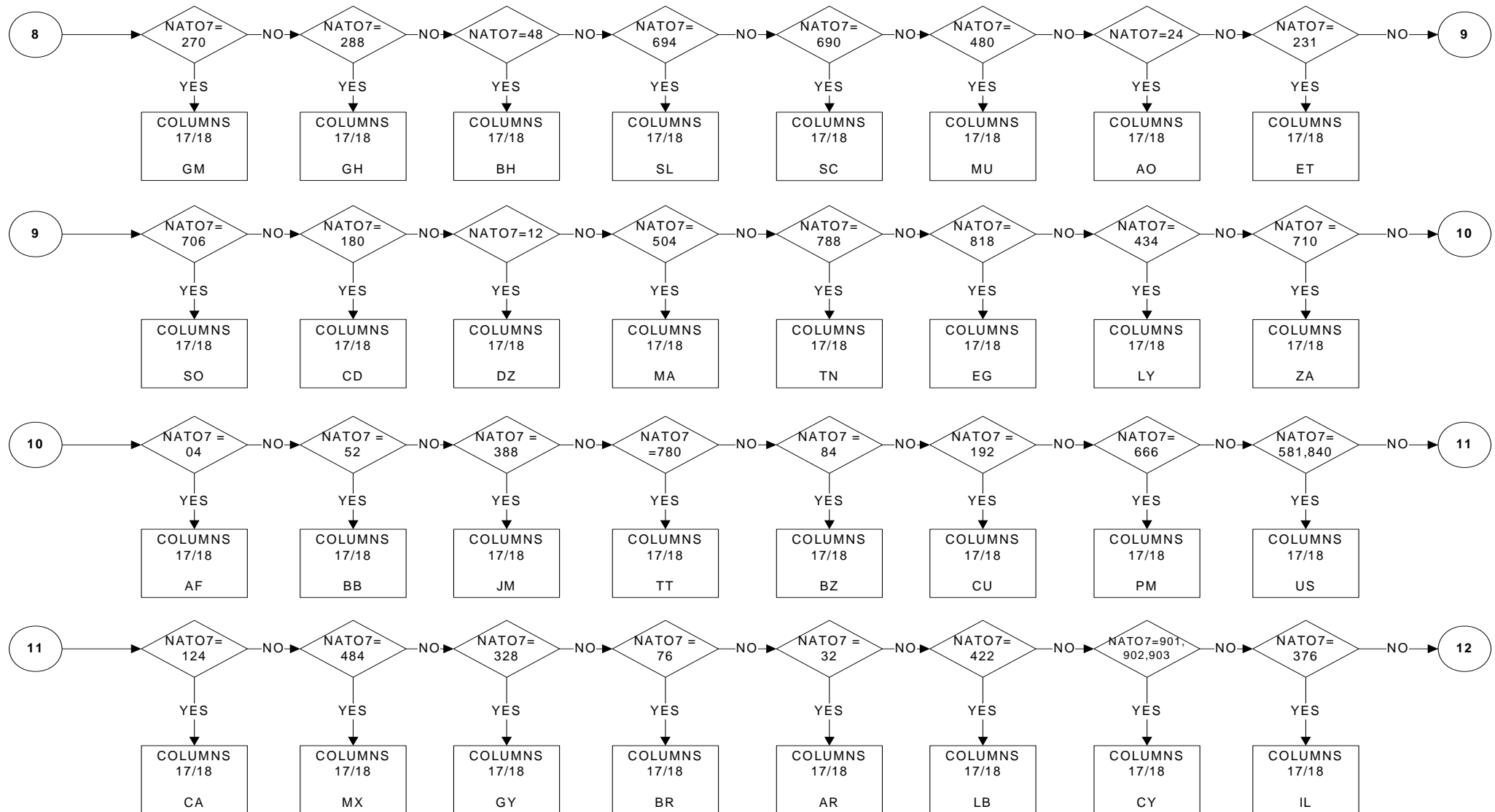

NATIONAL (ENAT): Nationality

Columns 17/18

PAGE 4 OF 7

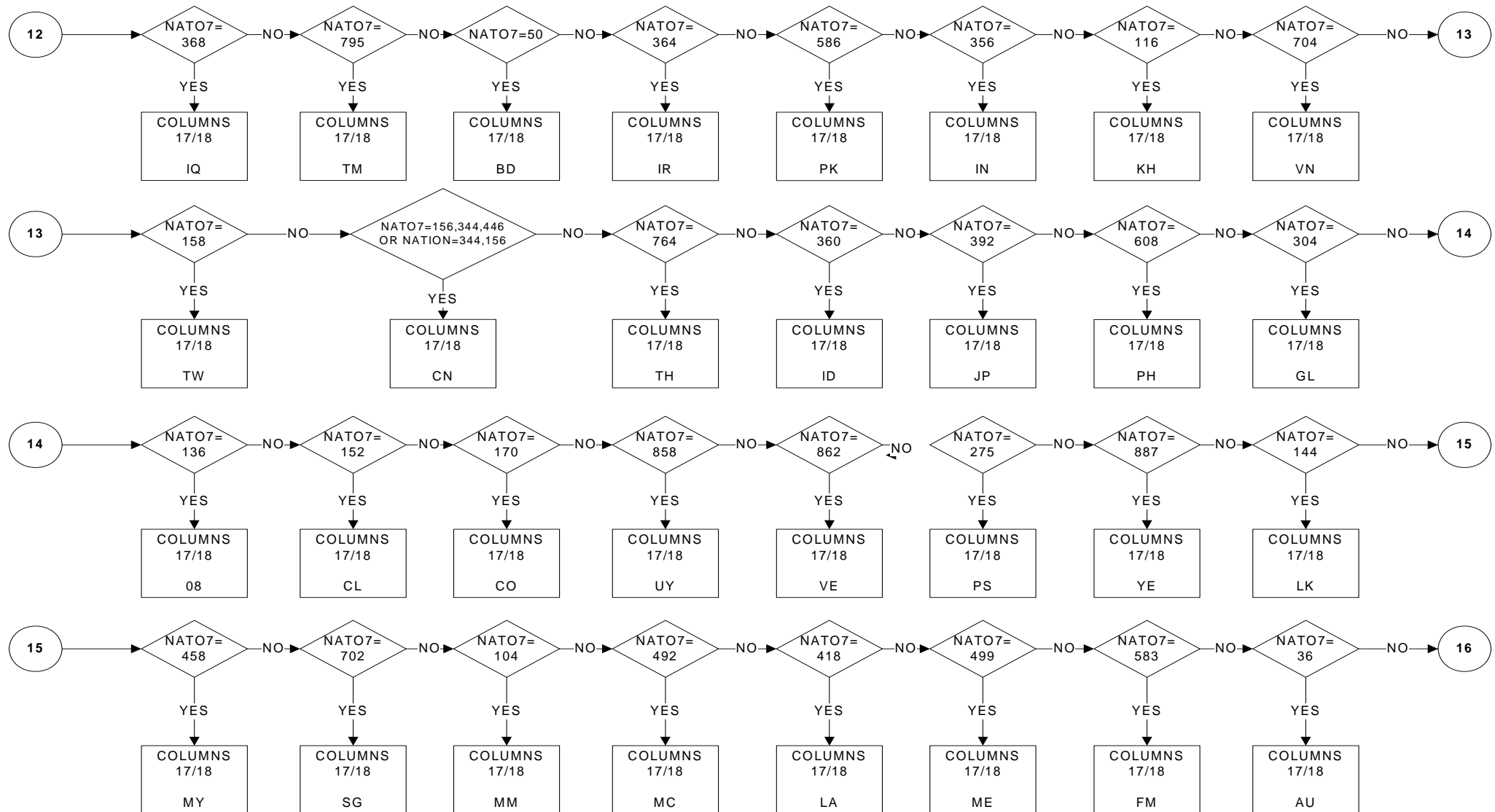

NATIONAL (ENAT): Nationality

Columns 17/18

PAGE 5 OF 7

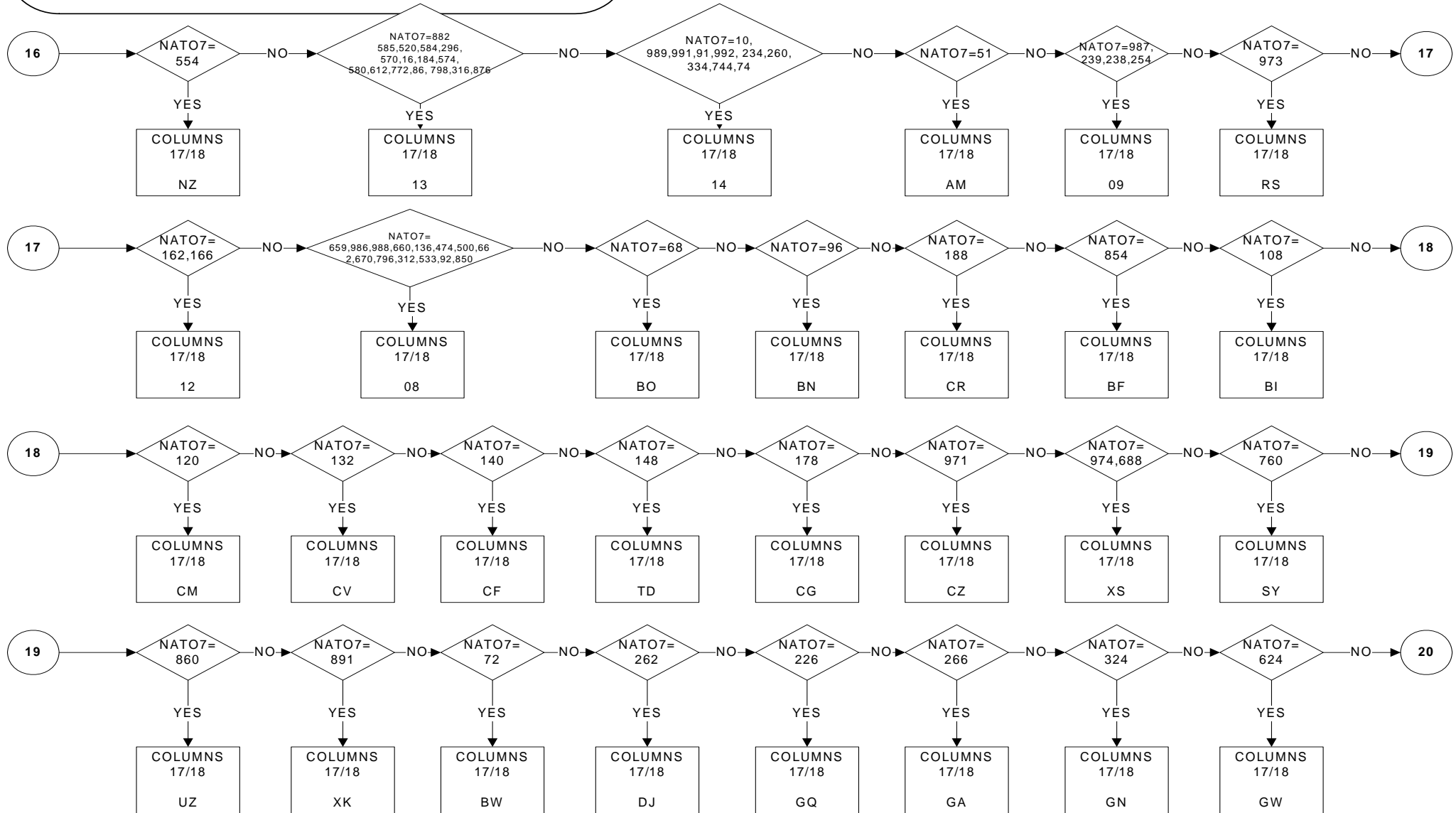

NATIONAL (ENAT): Nationality
Columns 17/18
 PAGE 6 OF 7

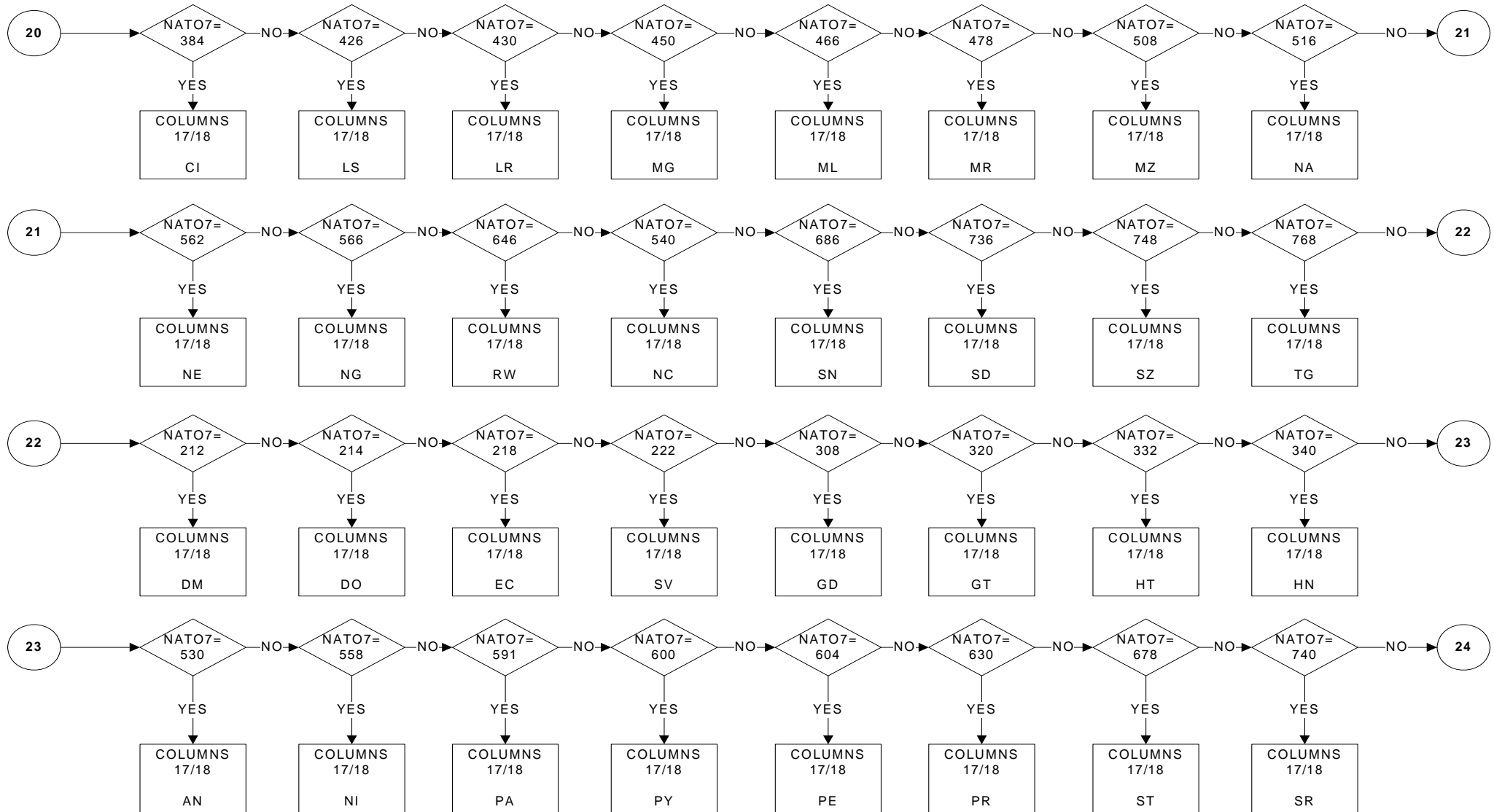

NATIONAL (ENAT): Nationality

Columns 17/18

PAGE 7 OF 7

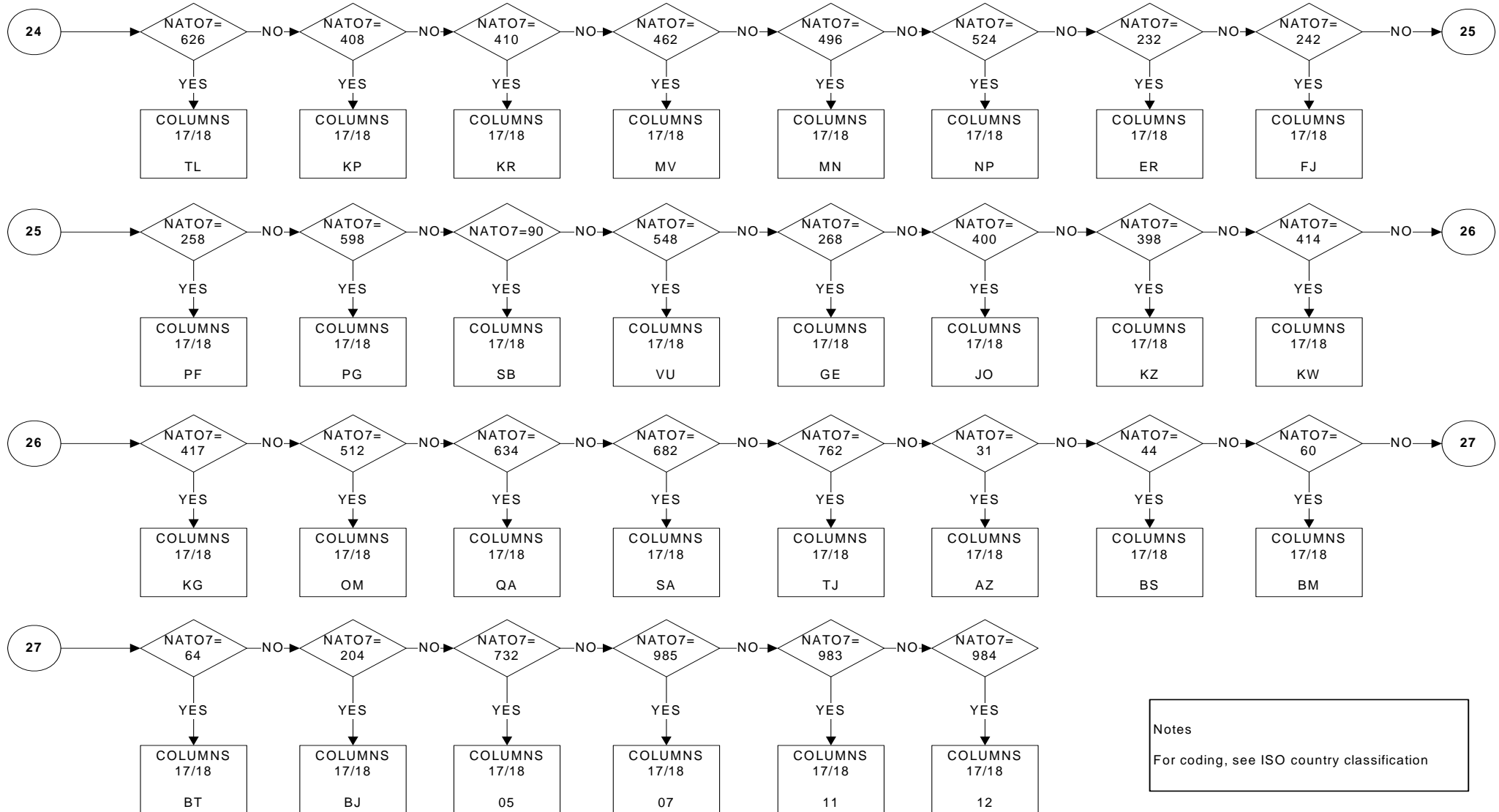

Notes

For coding, see ISO country classification

YEARESID (EYRSRES): Years of residence in this country

Column 19/20

PAGE 1 OF 2

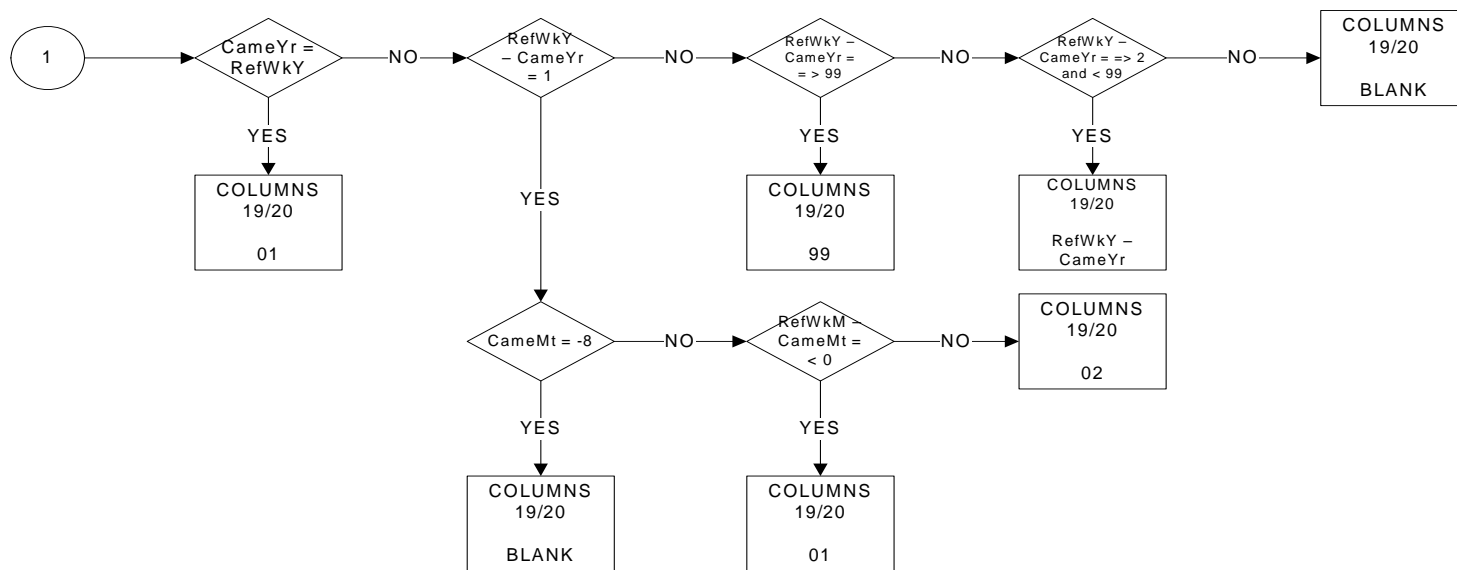
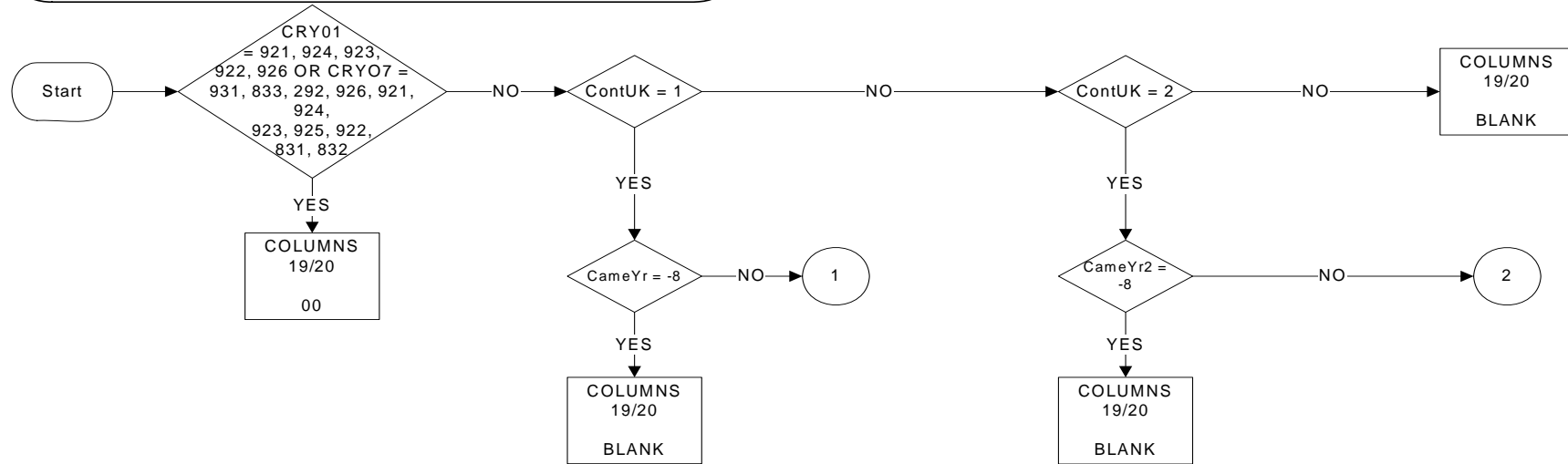

YEARESID (EYRSRES): Years of residence in this country

Column 19/20

PAGE 2 OF 2

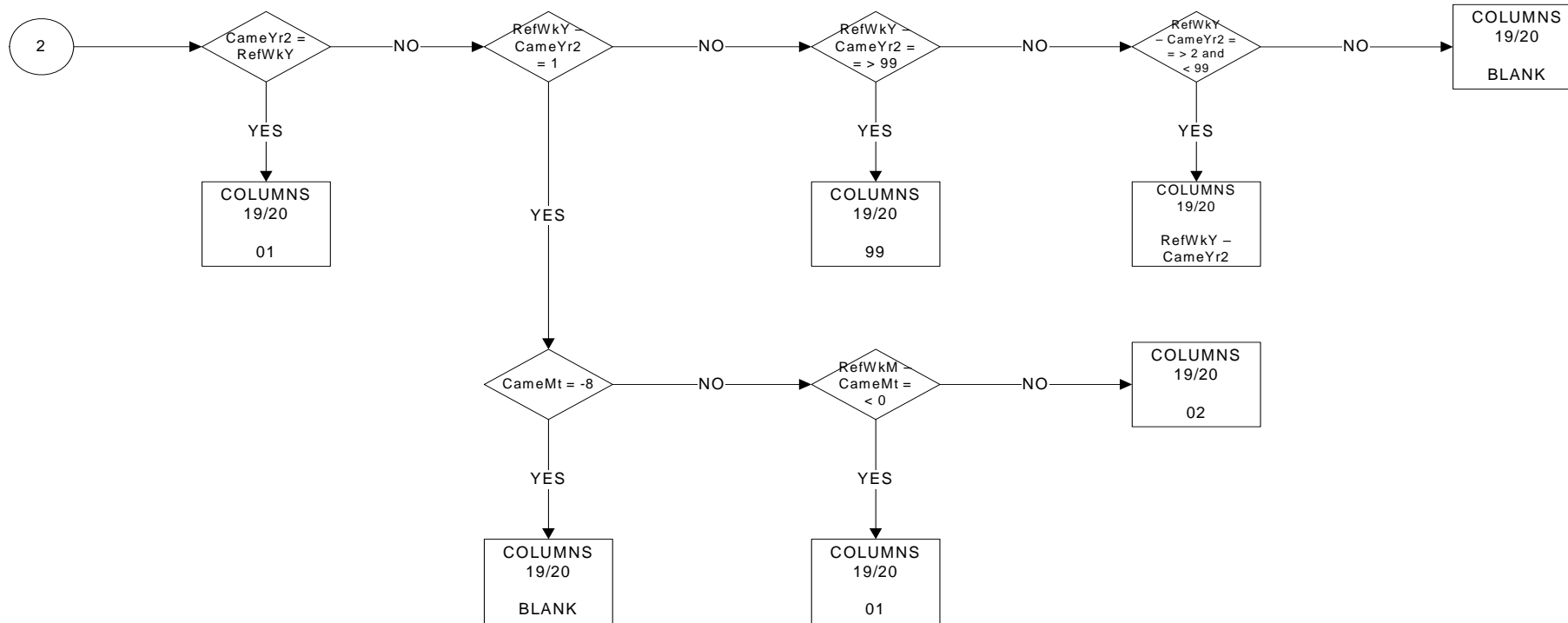

KEY

00 Born in this country
 01-99 Number of years of residence in this country
 BLANK No answer

Notes

Channel Island (7), Isle of Man (8) & Gibraltar (40) have been added to UK because they are not specified in 2006 codification

COUNTRYB (ECOB): Country of Birth

Columns 21/22

PAGE 1 OF 7

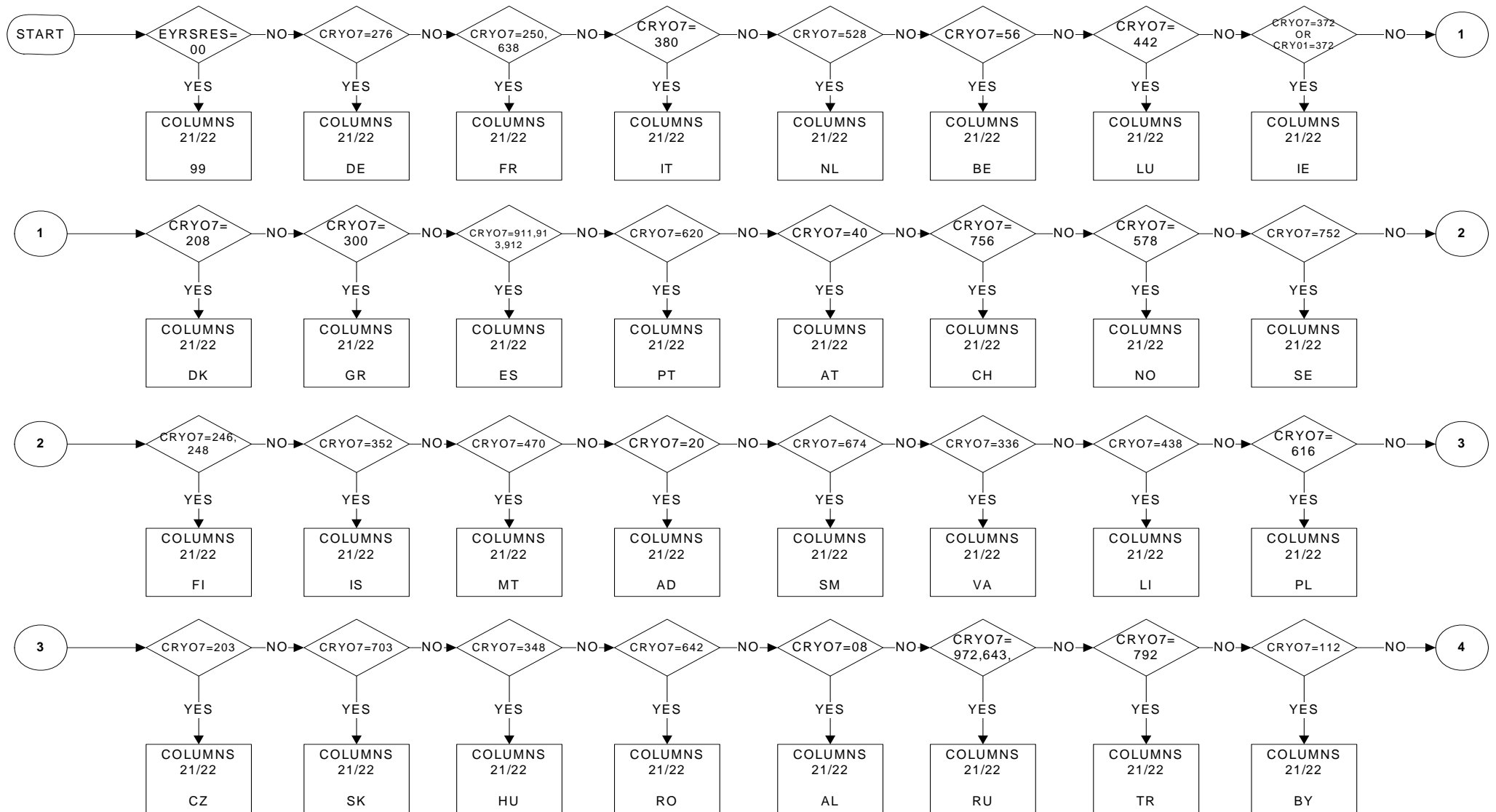

COUNTRYB (ECOB): Country of Birth

Columns 21/22

PAGE 2 OF 7

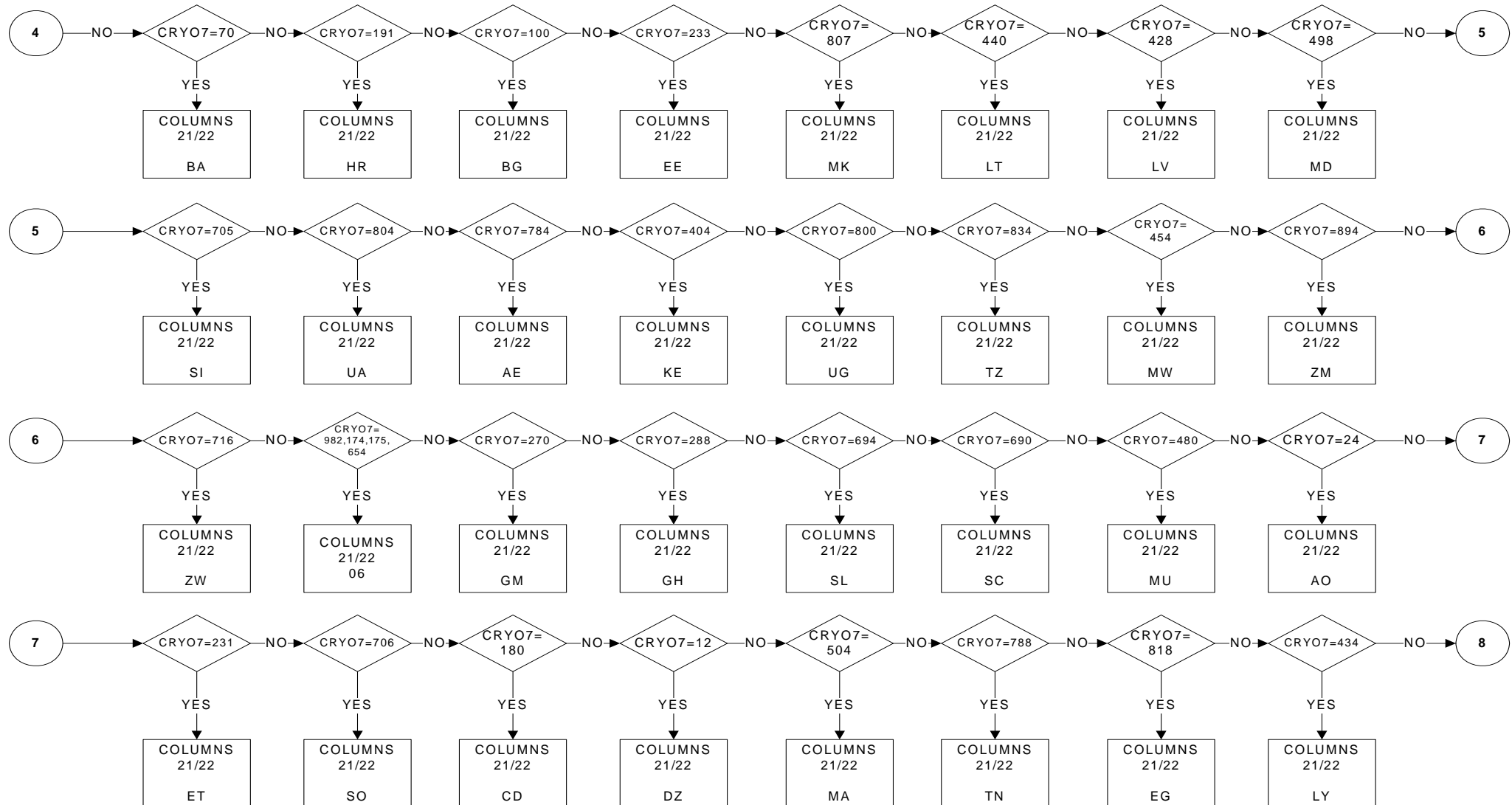

COUNTRYB (ECOB): Country of Birth

Columns 21/22

PAGE 3 OF 7

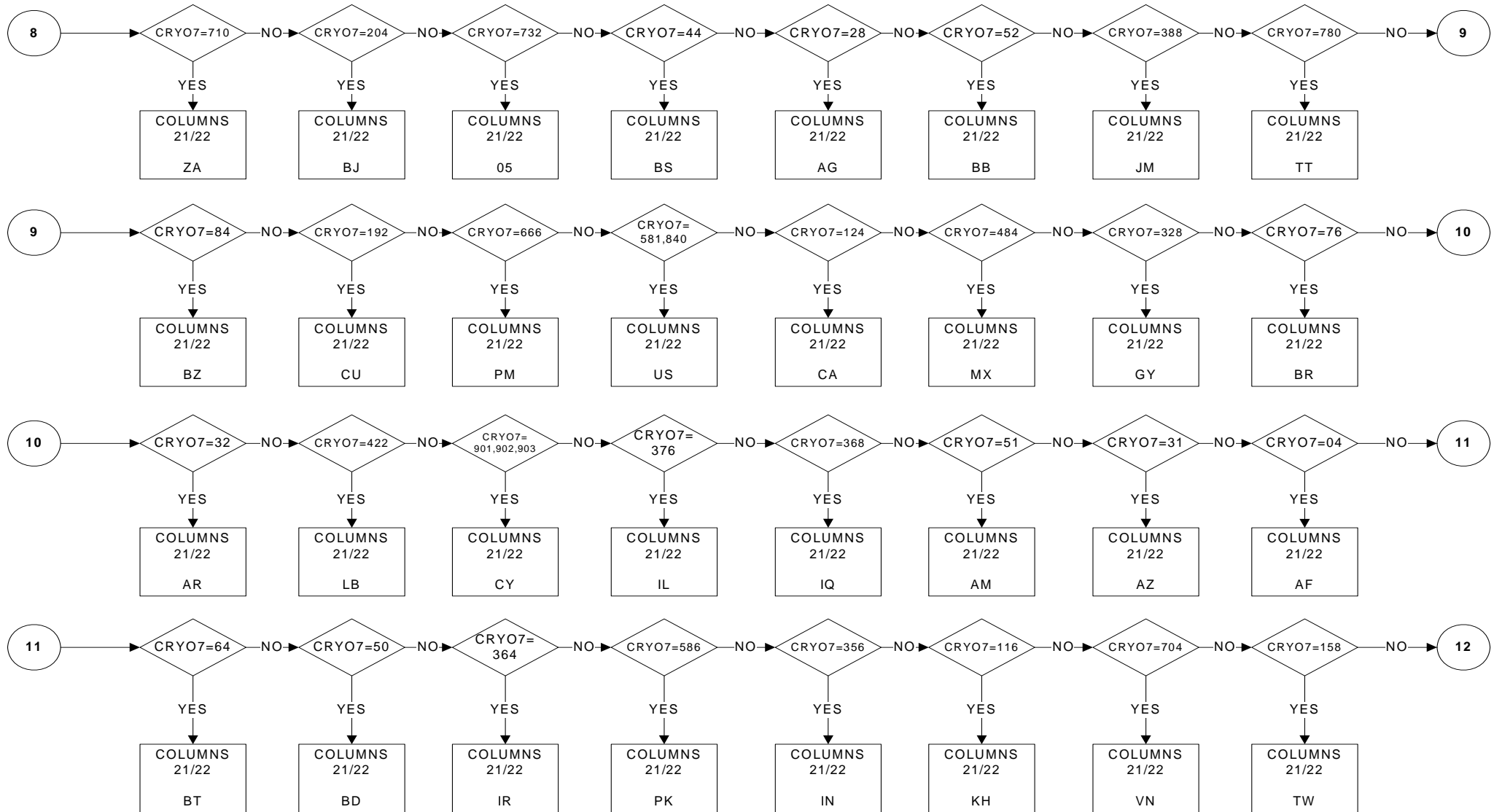

COUNTRYB (ECOB): Country of Birth

Columns 21/22

PAGE 4 OF 7

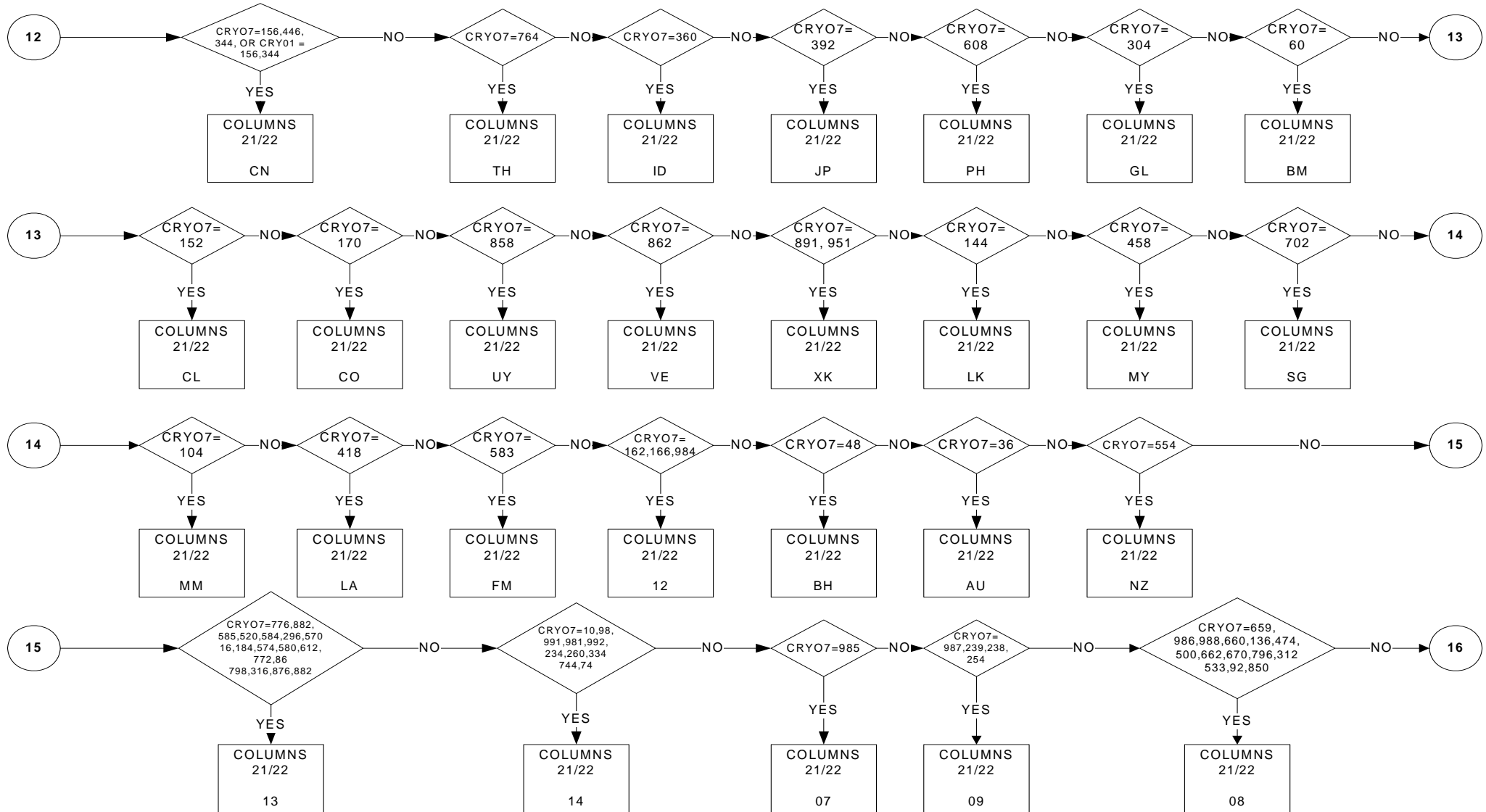

COUNTRYB (ECOB): Country of Birth

Columns 21/22

PAGE 5 OF 7

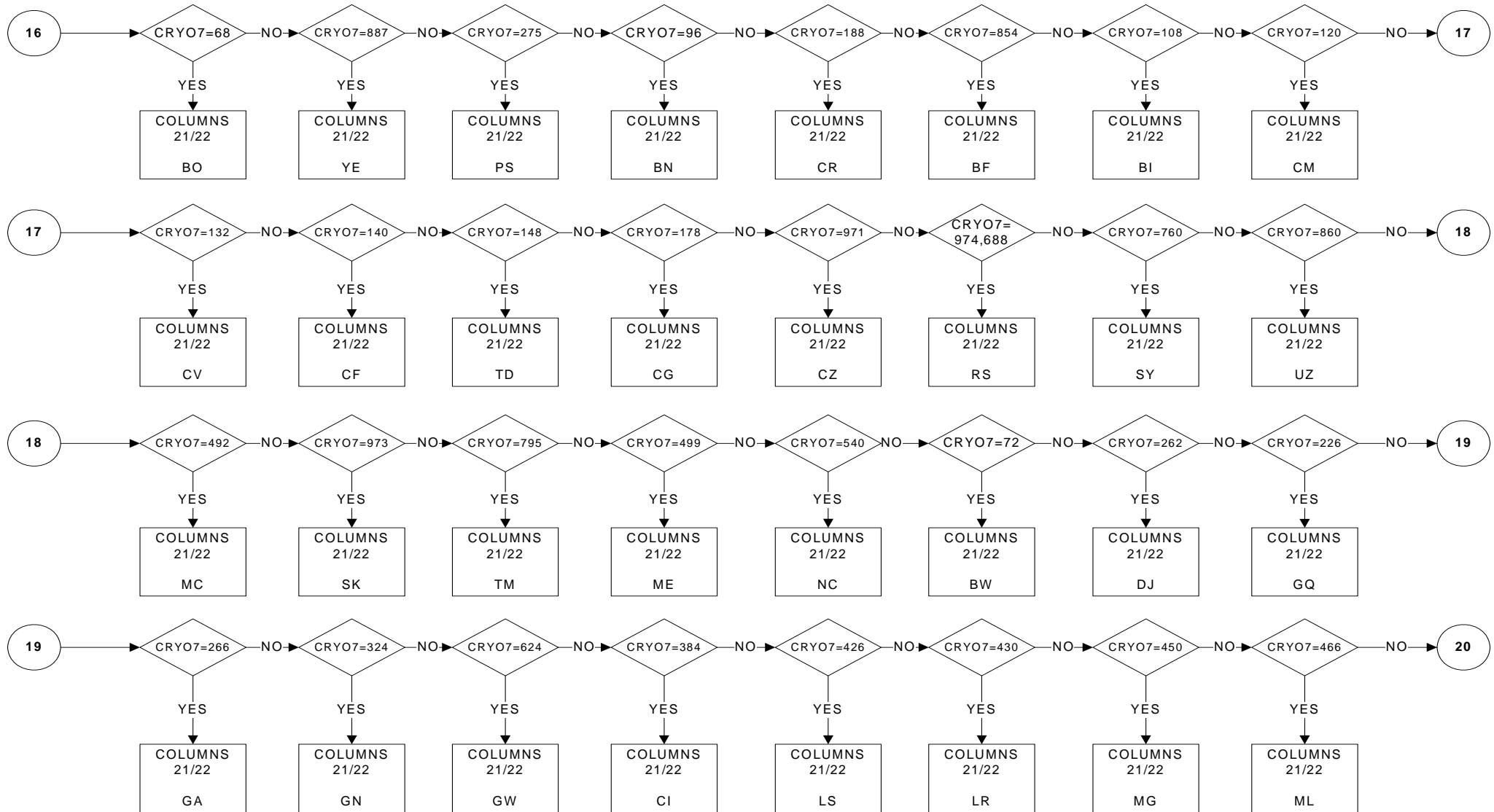

COUNTRYB (ECOB): Country of Birth

Columns 21/22

PAGE 6 OF 7

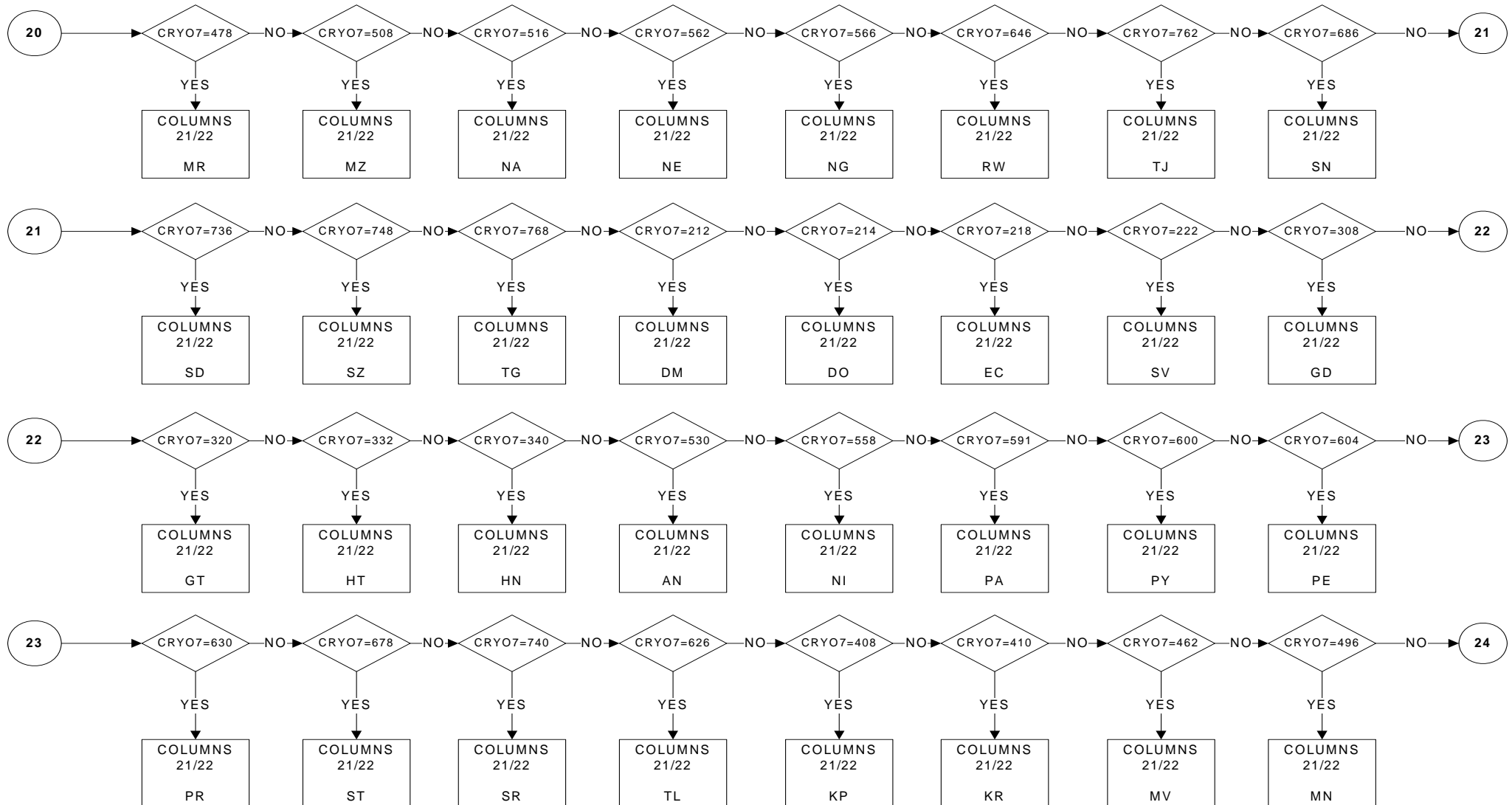

COUNTRYB (ECOB): Country of Birth

Columns 21/22

PAGE 7 OF 7

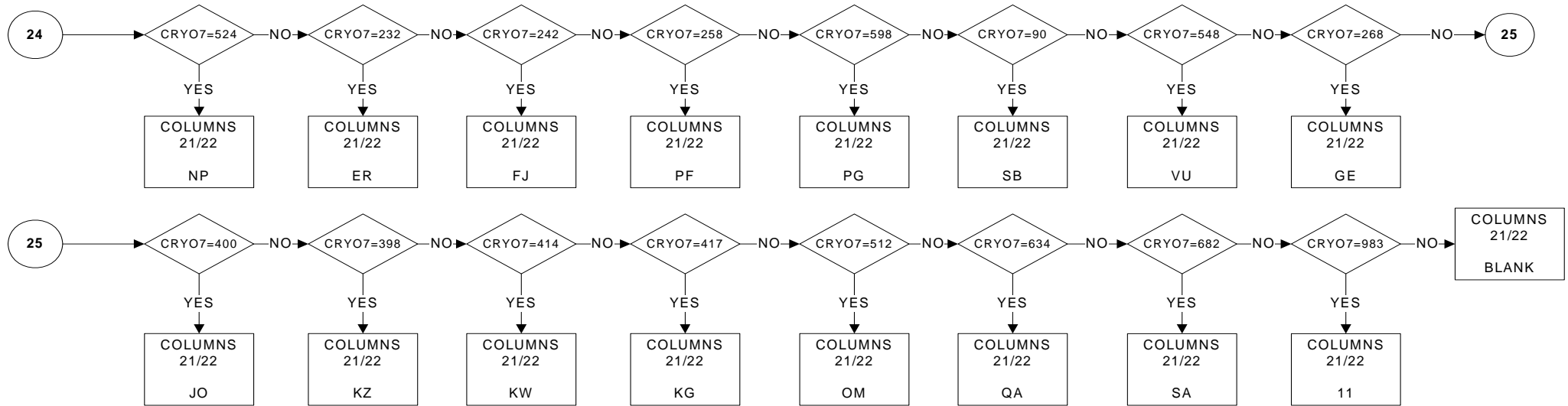

KEY

99 Not Applicable (Col 19/20 = 00)
 BLANK No Answer

Notes

For coding, see ISO country classification

PROXY (EPROXY): Nature of participation in survey

Column 23
PAGE 1 OF 1

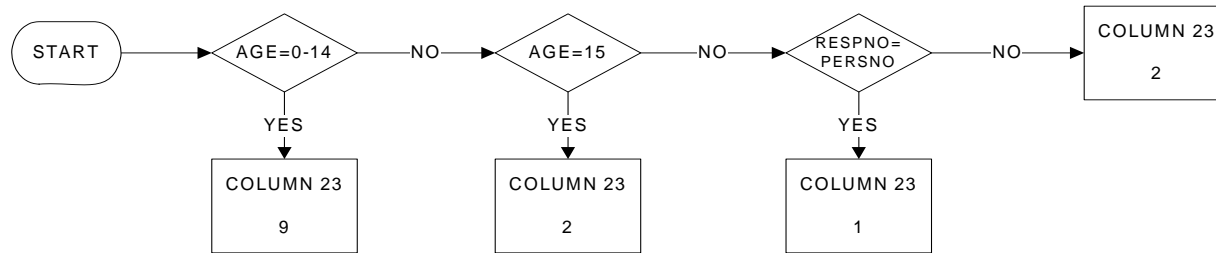

| KEY | |
|-------|---|
| 1 | Direct participation |
| 2 | Participation via another member of the household |
| 9 | Not applicable (child less than 15 years old) |
| BLANK | No answer |

WSTATOR (EWKSTATR): Labour status during the reference week
 Column 24
 PAGE 1 OF 2

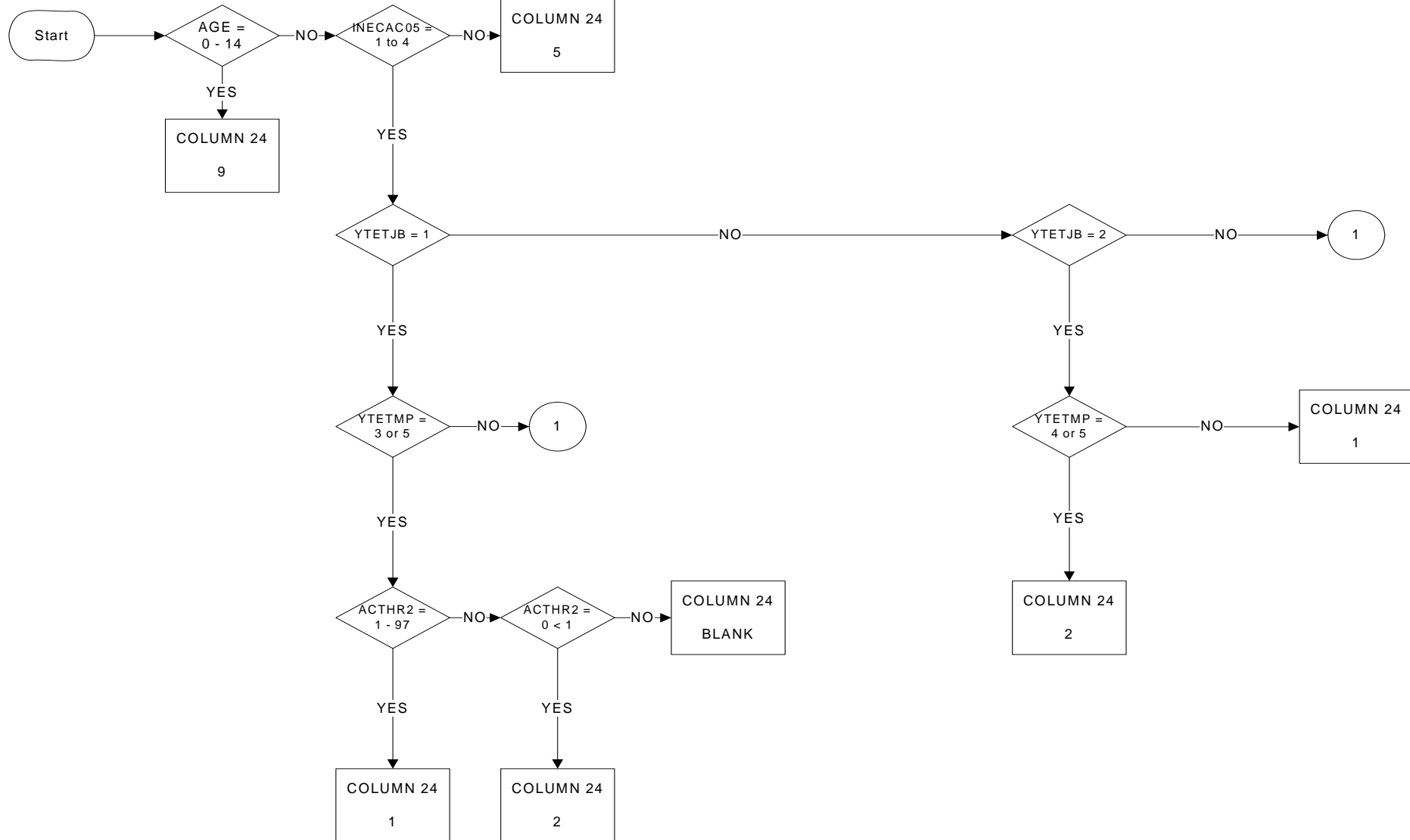

WSTATOR (EWKSTATR): Labour status during the reference week

Column 24

PAGE 2 OF 2

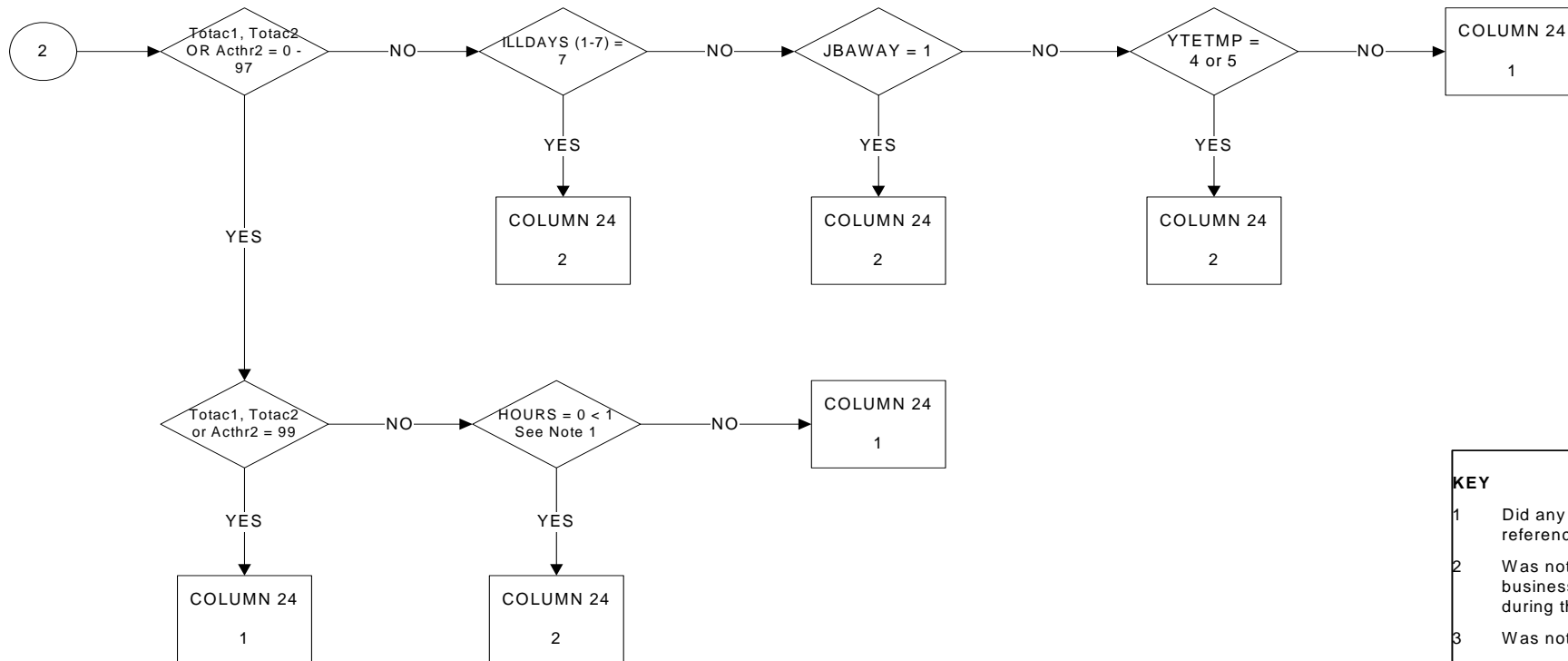

KEY

- 1 Did any work for pay or profit during the reference week - one hour or more
- 2 Was not working but had a job or business from which he/she was absent during the reference week
- 3 Was not working because on lay-off
- 4 Was a conscript on compulsory military or community service
- 5 Other (15 years or more) who neither worked nor had a job or business during the reference week
- 9 Not applicable (child less than 15 years old)

Note 1:

(TOTAC1 (if TOTAC1 >=0 and <= 97) +
TOTAC2 (if TOTAC2 >=0 and <= 97) +
ACTHR2 (if ACTHR2 >=0 and <= 97) =

0 to less than 1

NOWKREAS (ERESAWYR): Reason for not having worked at all though having a job

Column 25/26

PAGE 1 OF 2

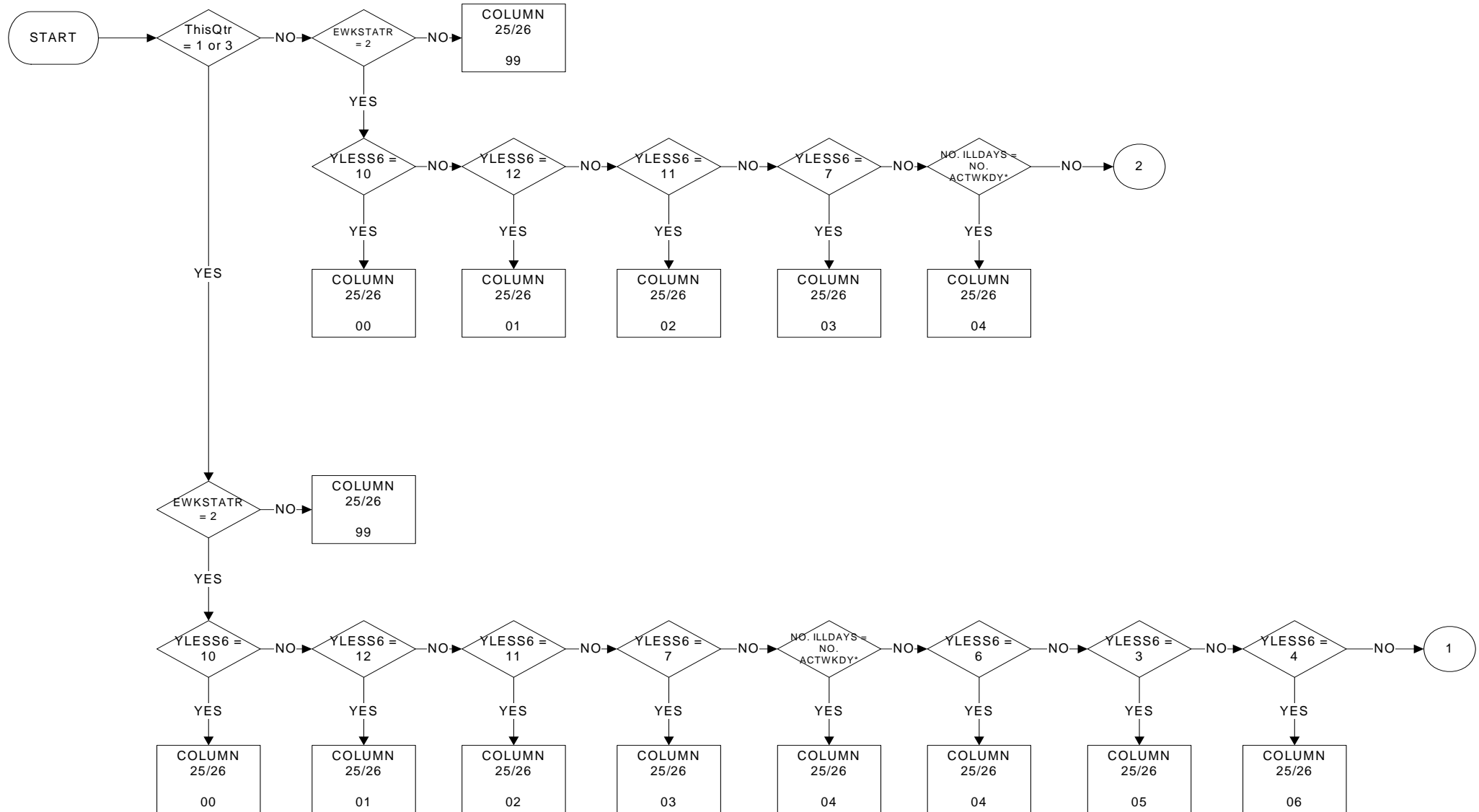

NOWKREAS (ERESAWYR): Reason for not having worked at all though having a job

Column 25/26

PAGE 2 OF 2

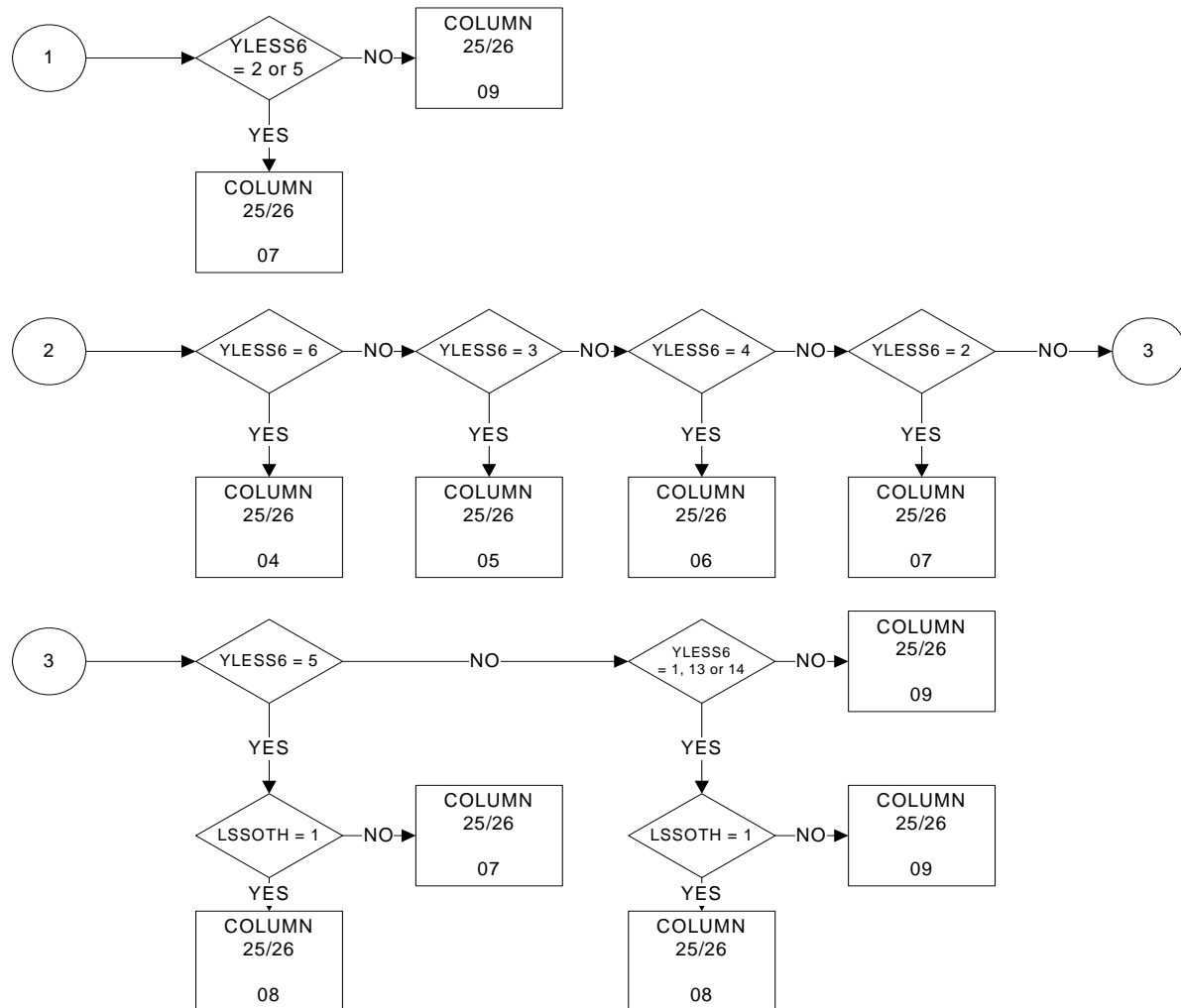

KEY

- 00 Bad weather
- 01 Slack work for technical or economic reasons
- 02 Labour dispute
- 03 School education or training
- 04 Own illness, injury or temporary disability
- 05 Maternity leave
- 06 Parental leave
- 07 Holidays
- 08 Compensation leave (within the framework of working time banking or an annualised hours contract)
- 09 Other reasons (e.g. personal or family responsibilities)
- 99 Not applicable (WSTATOR = 1, 3-5, 9)

Notes

LSSOTH asked in AJ and OD quarters only

* No. of positive replies in ILLDAYS(1-7) and ACTWKDY(1-7), and illdays > 0

STAPRO (ESTATR): Professional status

Column 27
PAGE 1 OF 1

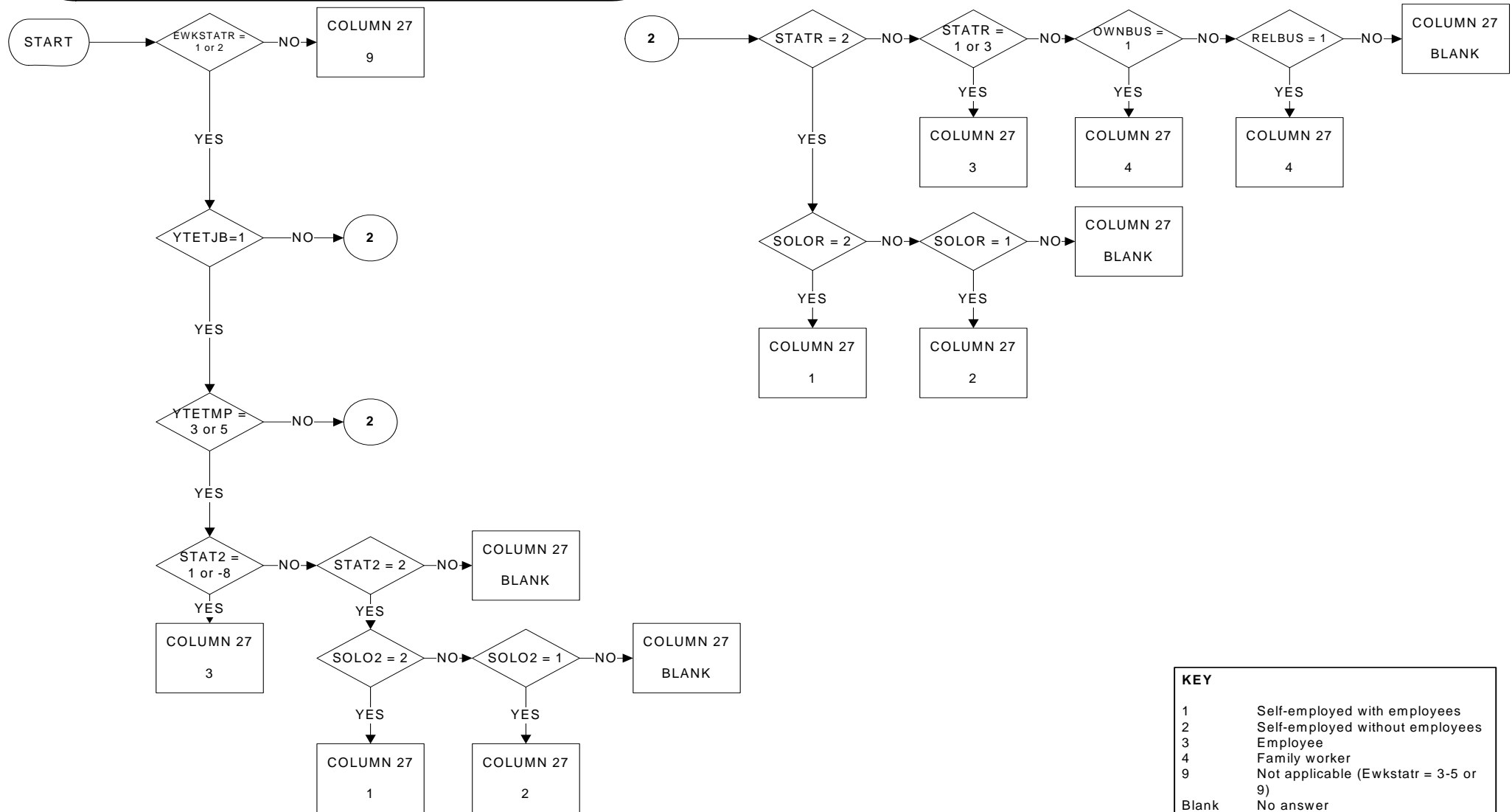

| KEY | |
|-------|--------------------------------------|
| 1 | Self-employed with employees |
| 2 | Self-employed without employees |
| 3 | Employee |
| 4 | Family worker |
| 9 | Not applicable (Ewkstatr = 3-5 or 9) |
| Blank | No answer |

SIGNISAL (EFISAL): Continuing receipt of wage or salary

Column 28
PAGE 1 OF 1

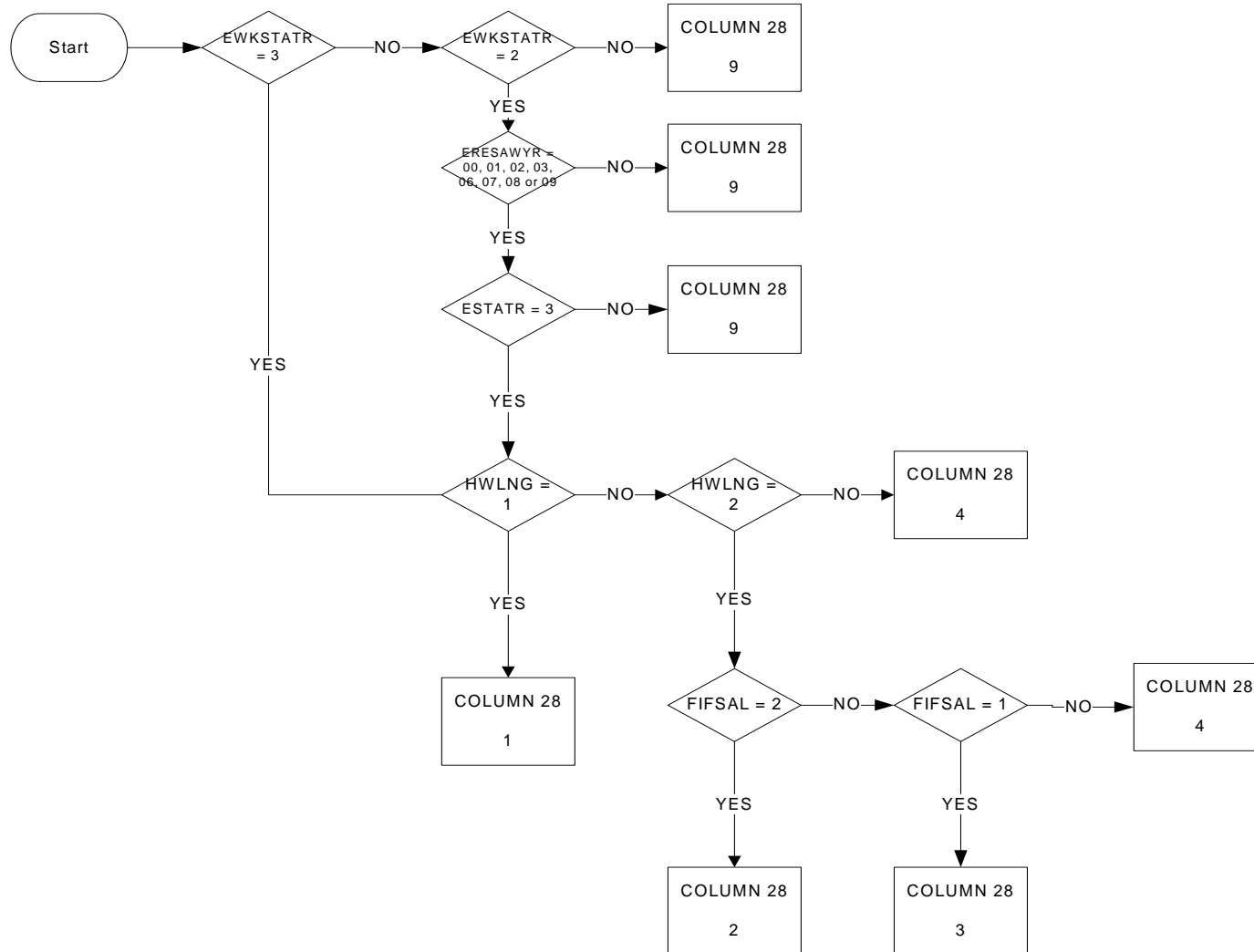

KEY

- 1 Absent for up to and including 3 months
- 2 Absent for more than 3 months and receiving a wage, salary or social allowances corresponding to half or more of the salary
- 3 Absent for more than 3 months and receiving a wage, salary or social allowances corresponding to less than half of the salary
- 4 Don't know
- 9 Not applicable ((WSTATOR ? 2 or NOWKREAS = 04 or NOWKREAS = 05 or STAPRO ? 3) and WSTATOR ? 3)

NACE3D (ENACE08): Economic activity of the local unit

Column 29/31

PAGE 1 OF 1

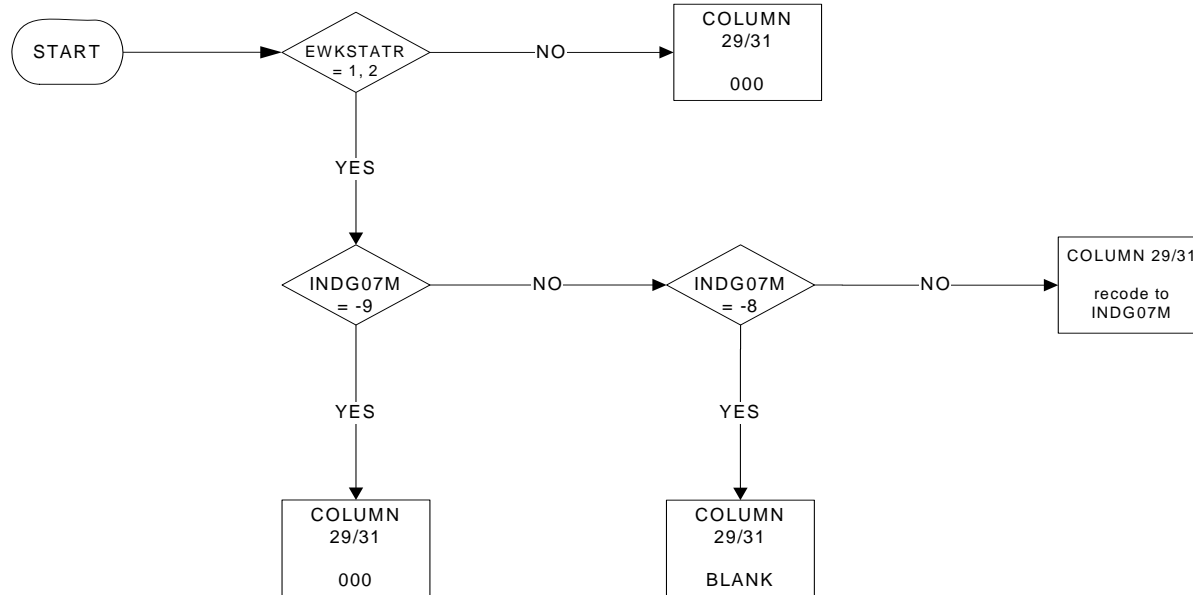

KEY

NACE Rev. 2 coded at 2 or if possible 3 digit level

000 Not applicable (WSTATOR = 3-5, 9)

Blank No answer

ISCO4D (EISCOMR): Occupation

Columns 32/35

PAGE 1 OF 3

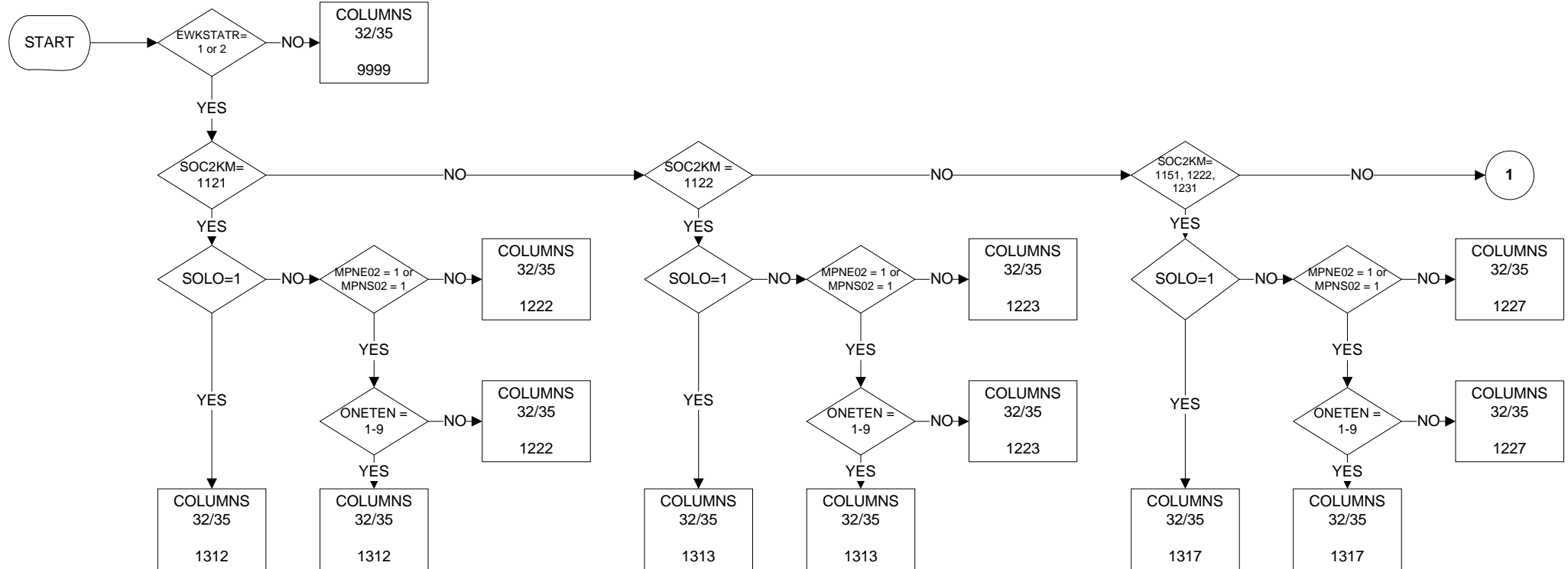

ISCO4D (EISCOMR): Occupation

Columns 32/35

PAGE 2 OF 3

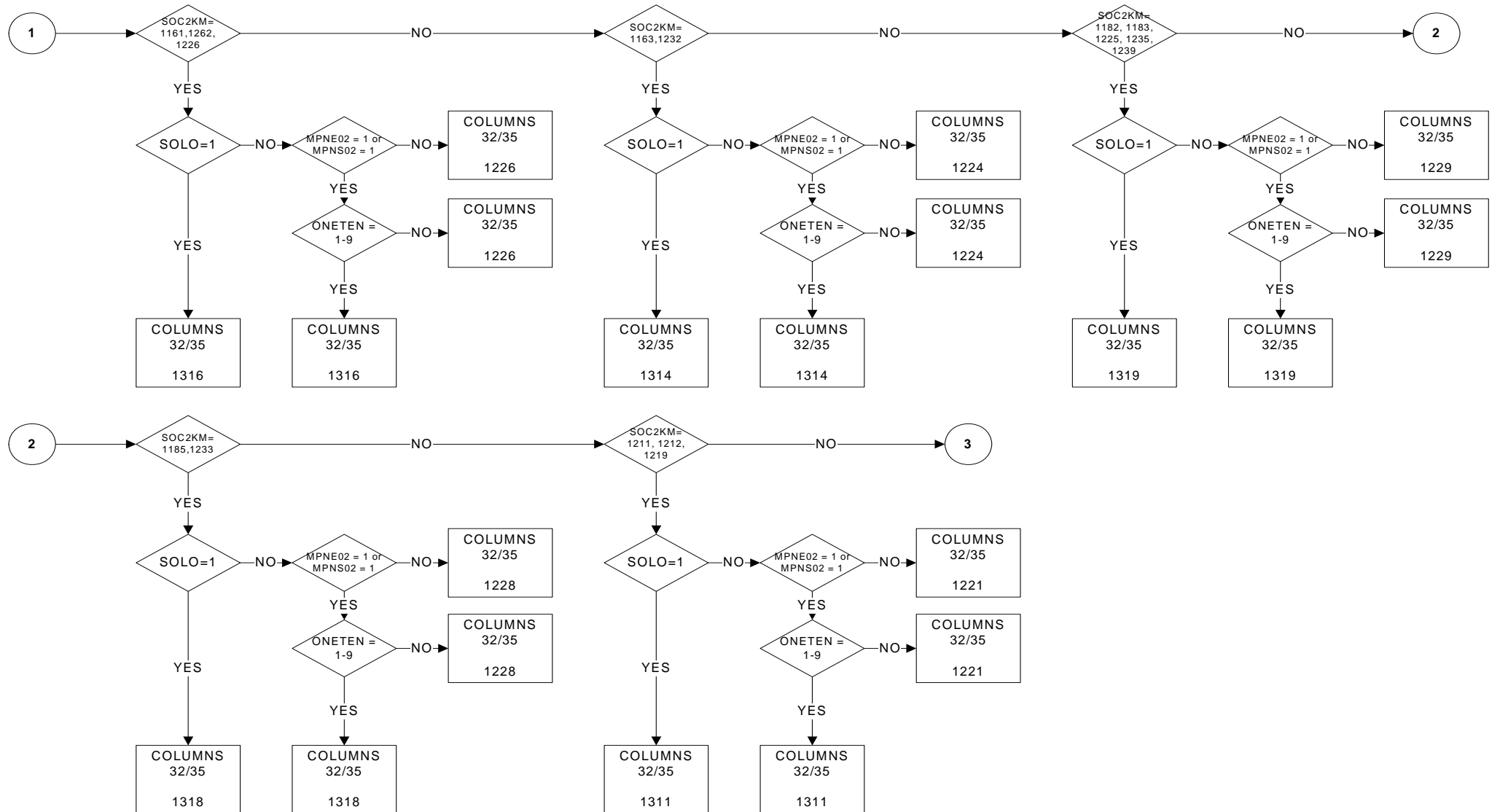

ISCO4D (EISCOMR): Occupation

Columns 32/35

PAGE 3 OF 3

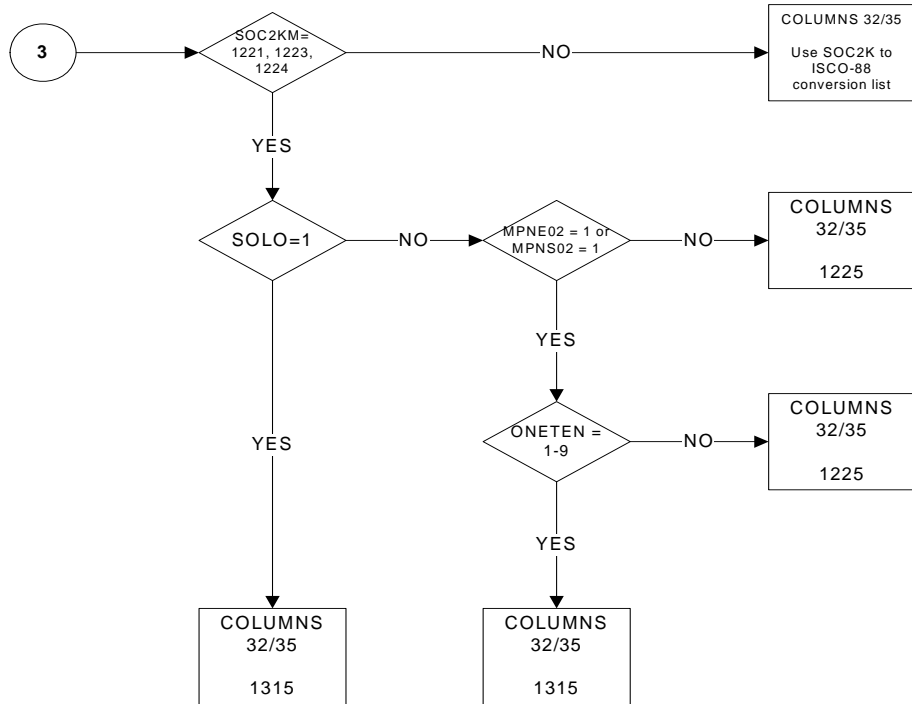

KEY

9999 Not applicable (WSTATOR = 3-5,9)

blank No answer

Notes

ISCO-88 (COM) coded at 3 or if possible 4 digit level

The questionnaire variables SOLO and MPNE/MPNS can be used as EWKSTATR filters for current job only.

SUPVISOR (ESUPVIS): Supervisory responsibilities

Column 36

PAGE 1 OF 1

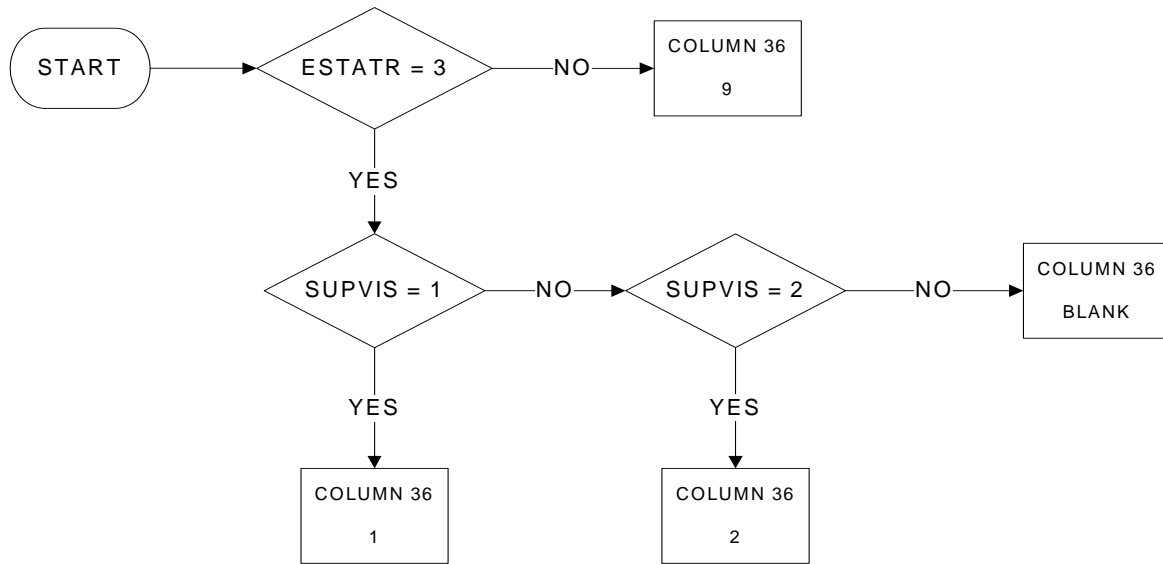

| KEY | |
|-------|--------------------------|
| 1 | Yes |
| 2 | No |
| 9 | STAPRO is not equal to 3 |
| blank | No answer |

SIZEFIRM (ENUMPR): Number of persons working at the local unit

Columns 37/38

PAGE 1 OF 1

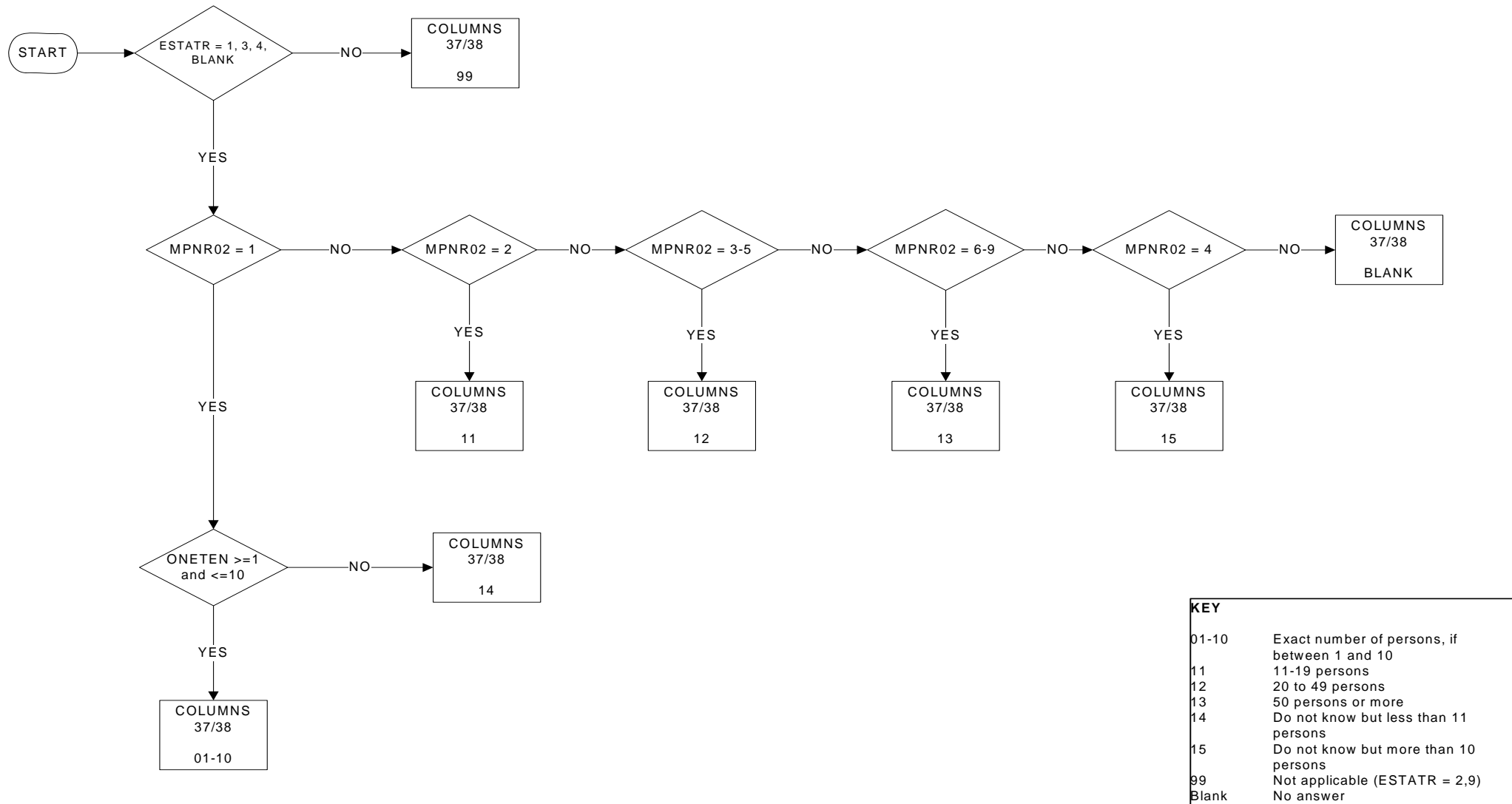

| KEY | |
|-------|--|
| 01-10 | Exact number of persons, if between 1 and 10 |
| 11 | 11-19 persons |
| 12 | 20 to 49 persons |
| 13 | 50 persons or more |
| 14 | Do not know but less than 11 persons |
| 15 | Do not know but more than 10 persons |
| 99 | Not applicable (ESTATR = 2,9) |
| Blank | No answer |

COUNTRYW (ECONWRK): Country of place of work

Columns 39/40

PAGE 1 OF 7

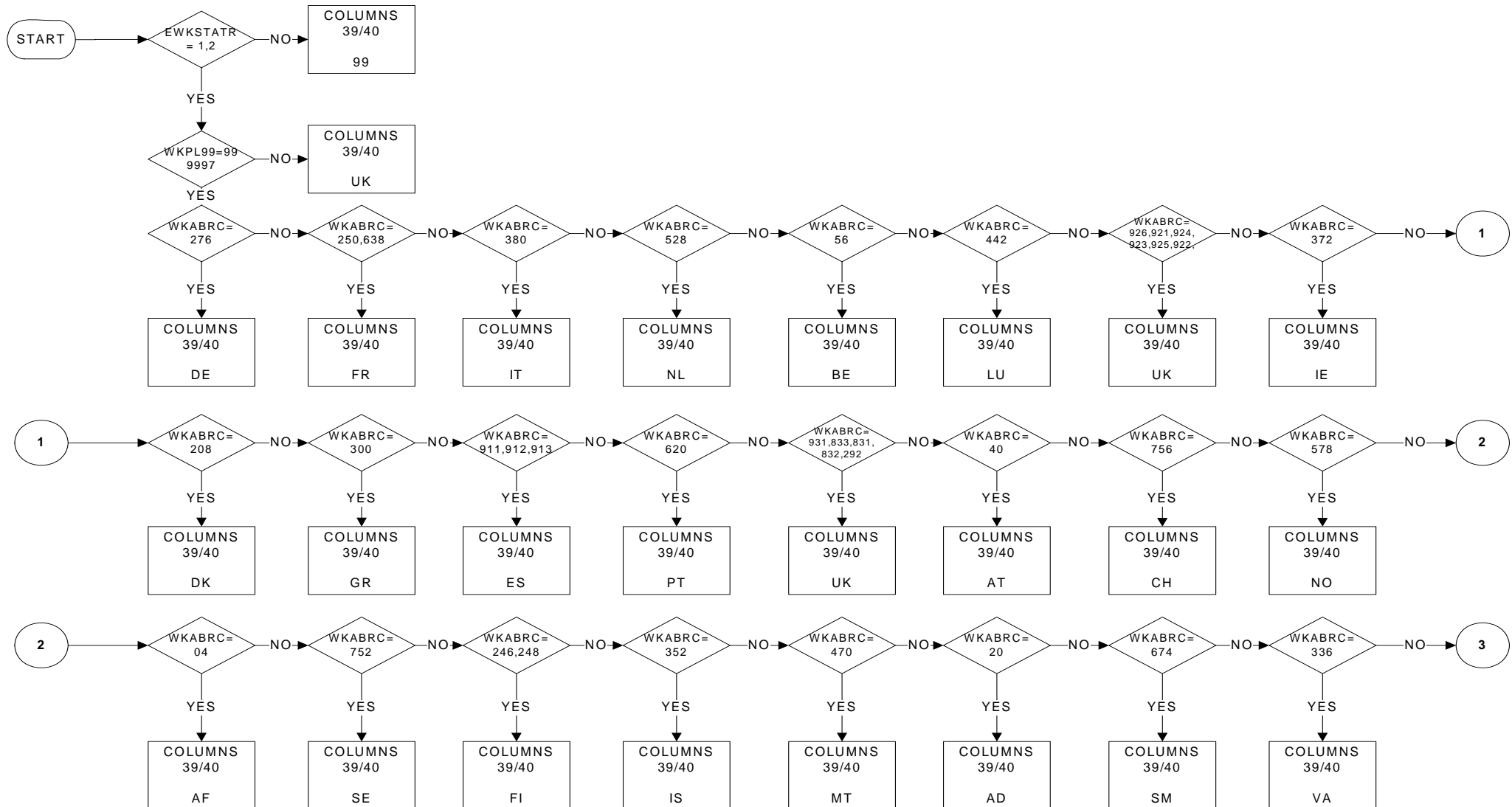

COUNTRYW (ECONWRK): Country of place of work

Columns 39/40

PAGE 2 OF 7

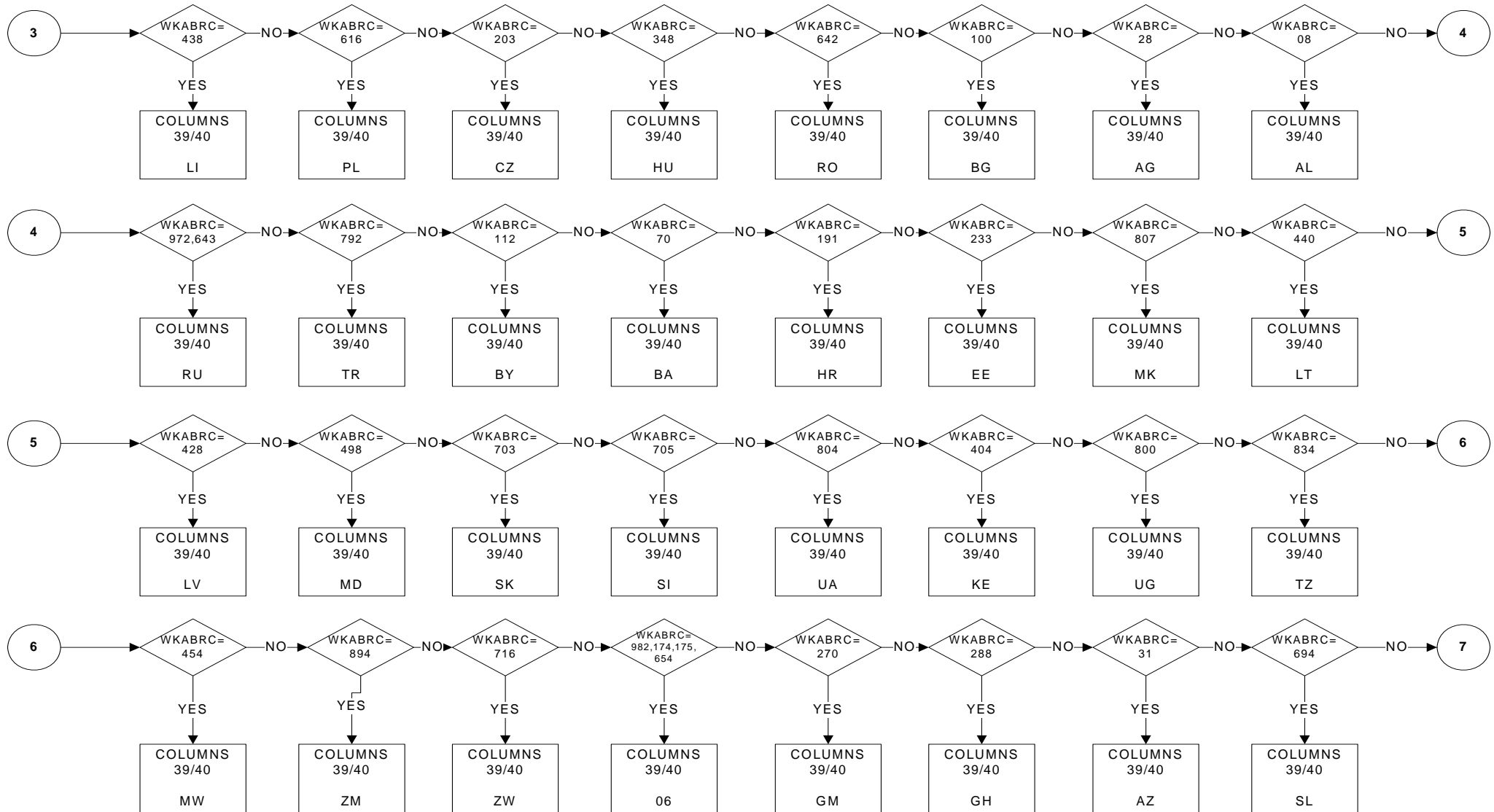

COUNTRYW (ECONWRK): Country of place of work

Columns 39/40

PAGE 3 OF 7

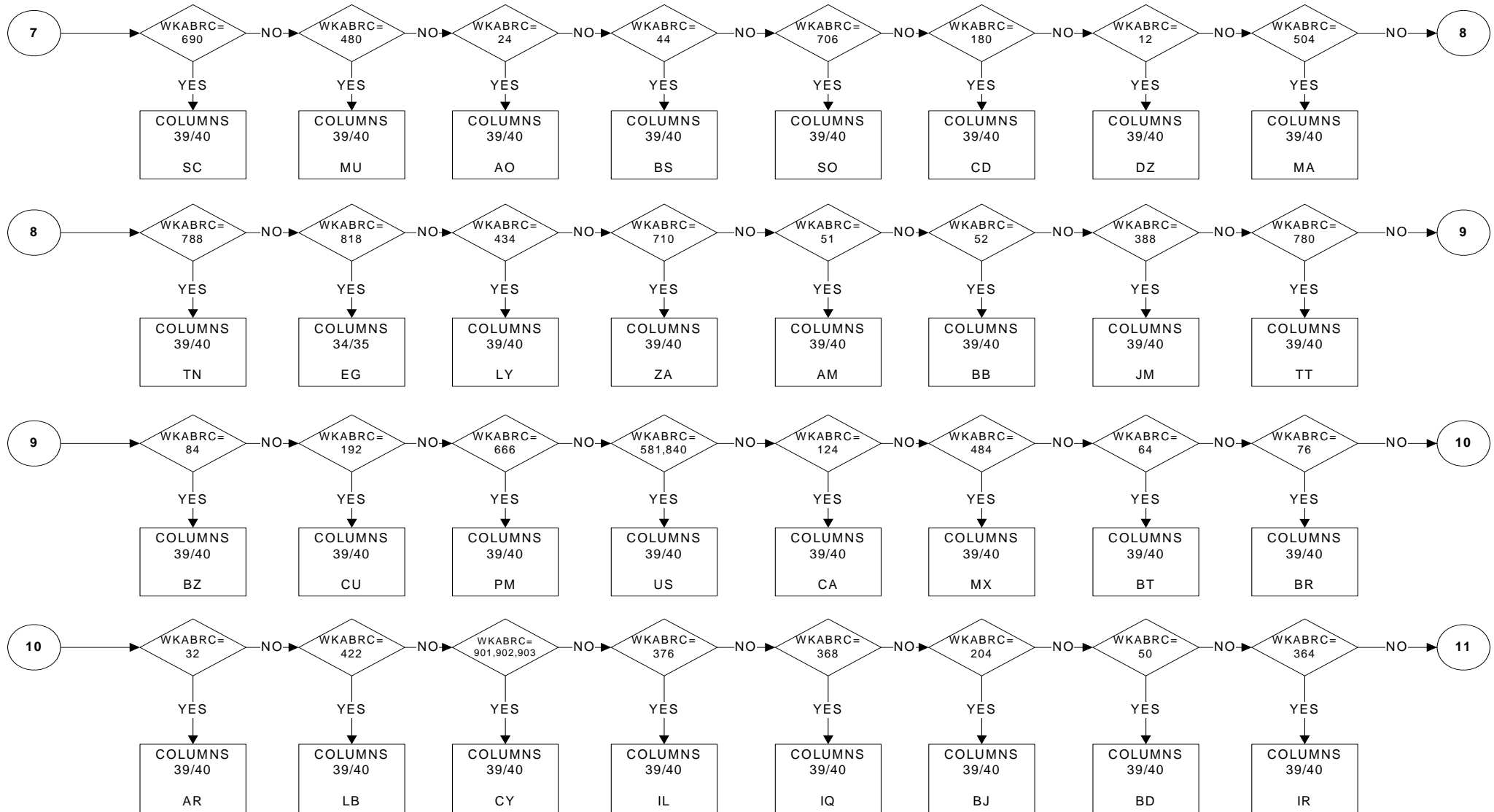

COUNTRYW (ECONWRK): Country of place of work

Columns 39/40

PAGE 4 OF 7

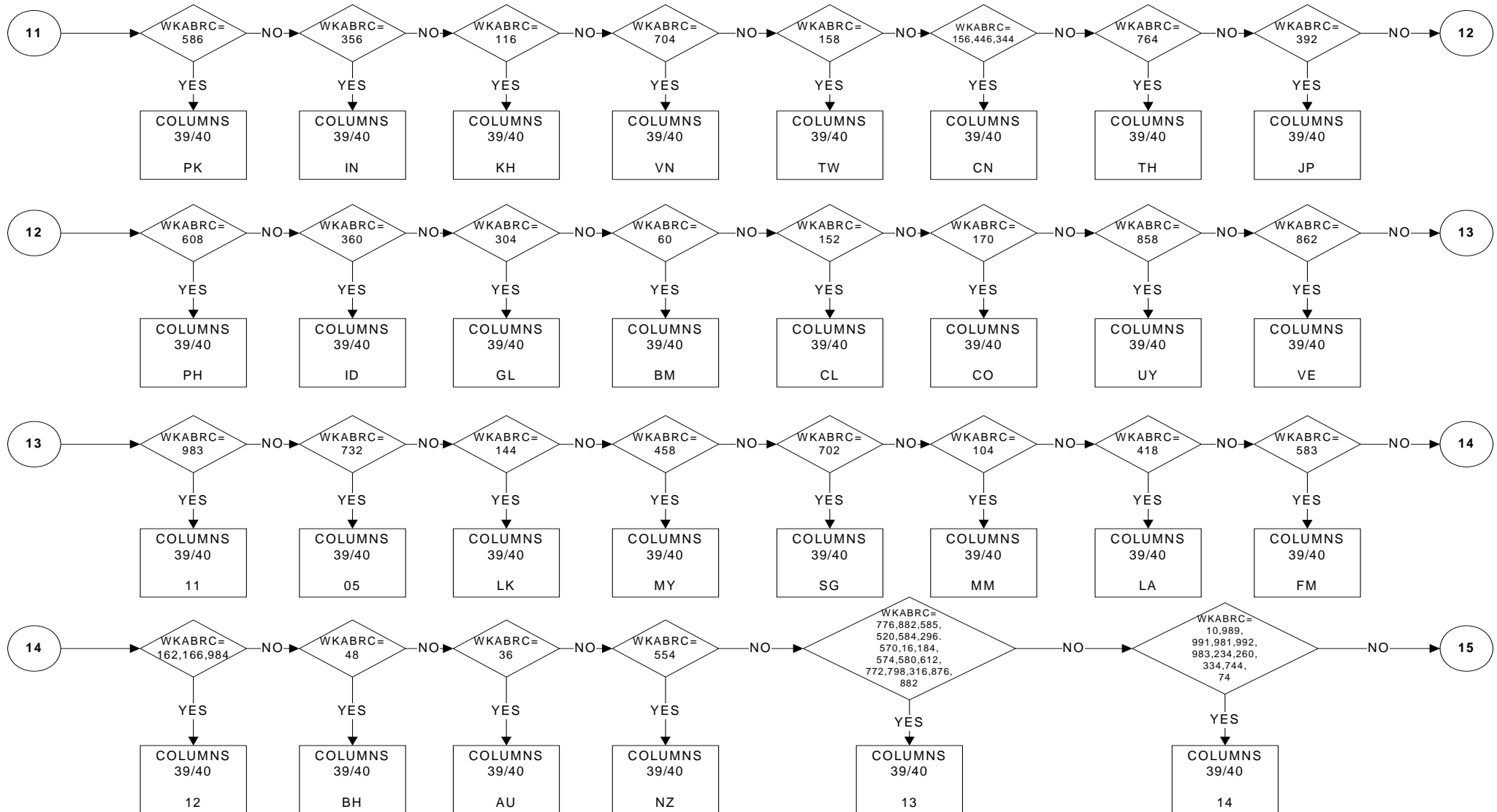

COUNTRYW (ECONWRK): Country of place of work

Columns 39/40

PAGE 5 OF 7

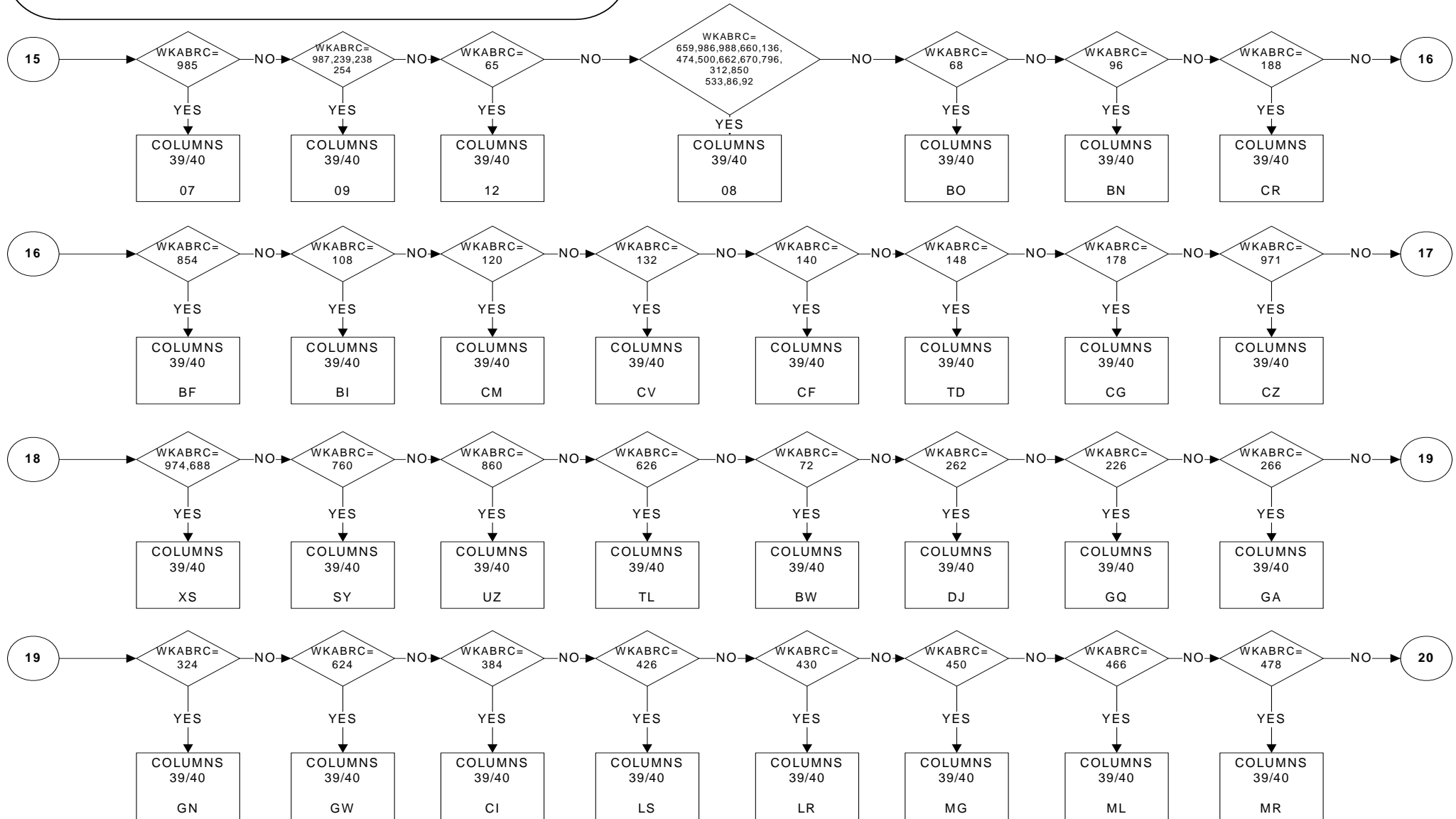

COUNTRYW (ECONWRK): Country of place of work

Columns 39/40

PAGE 6 OF 7

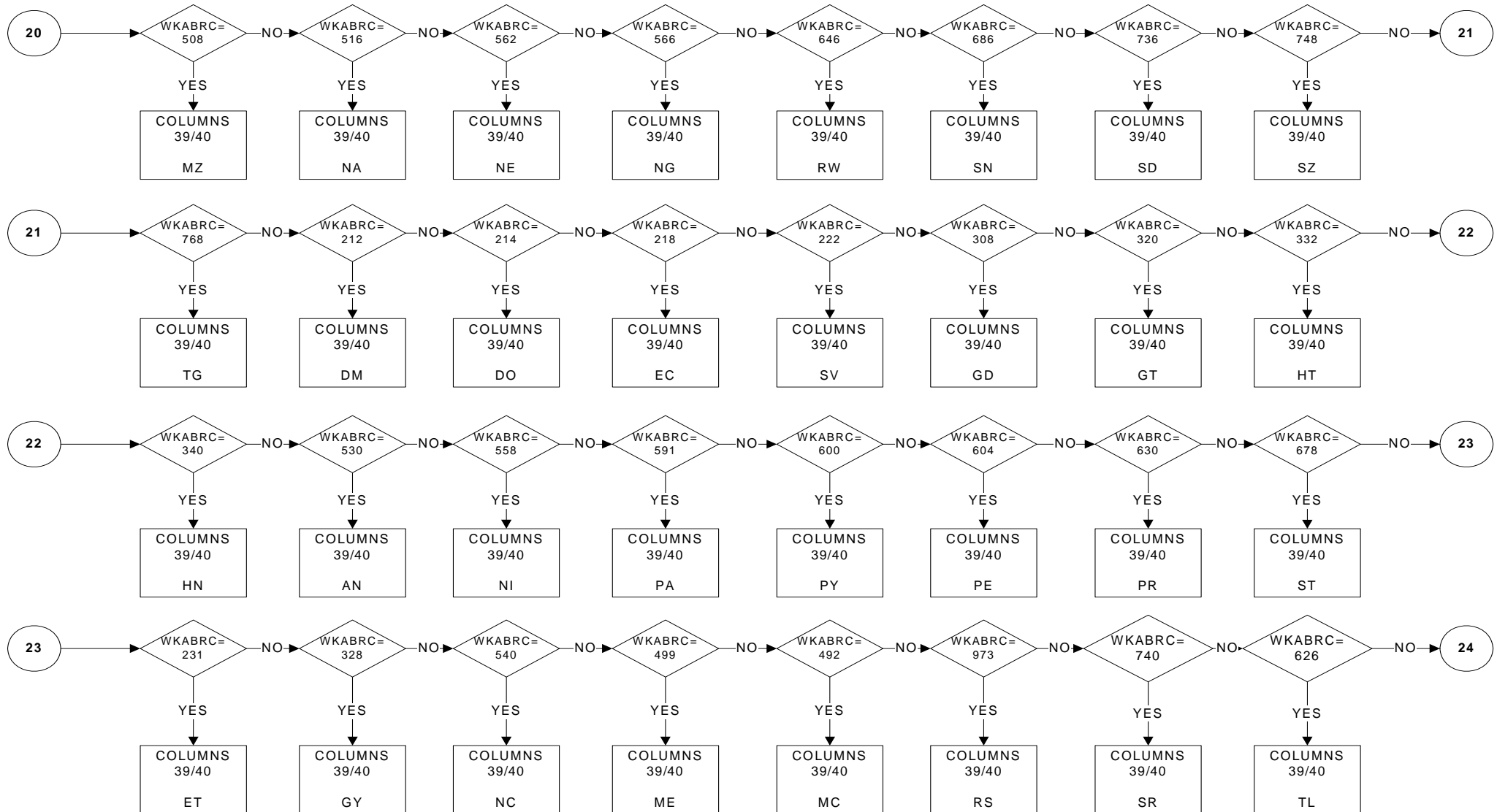

COUNTRYW (ECONWRK): Country of place of work

Columns 39/40

PAGE 7 OF 7

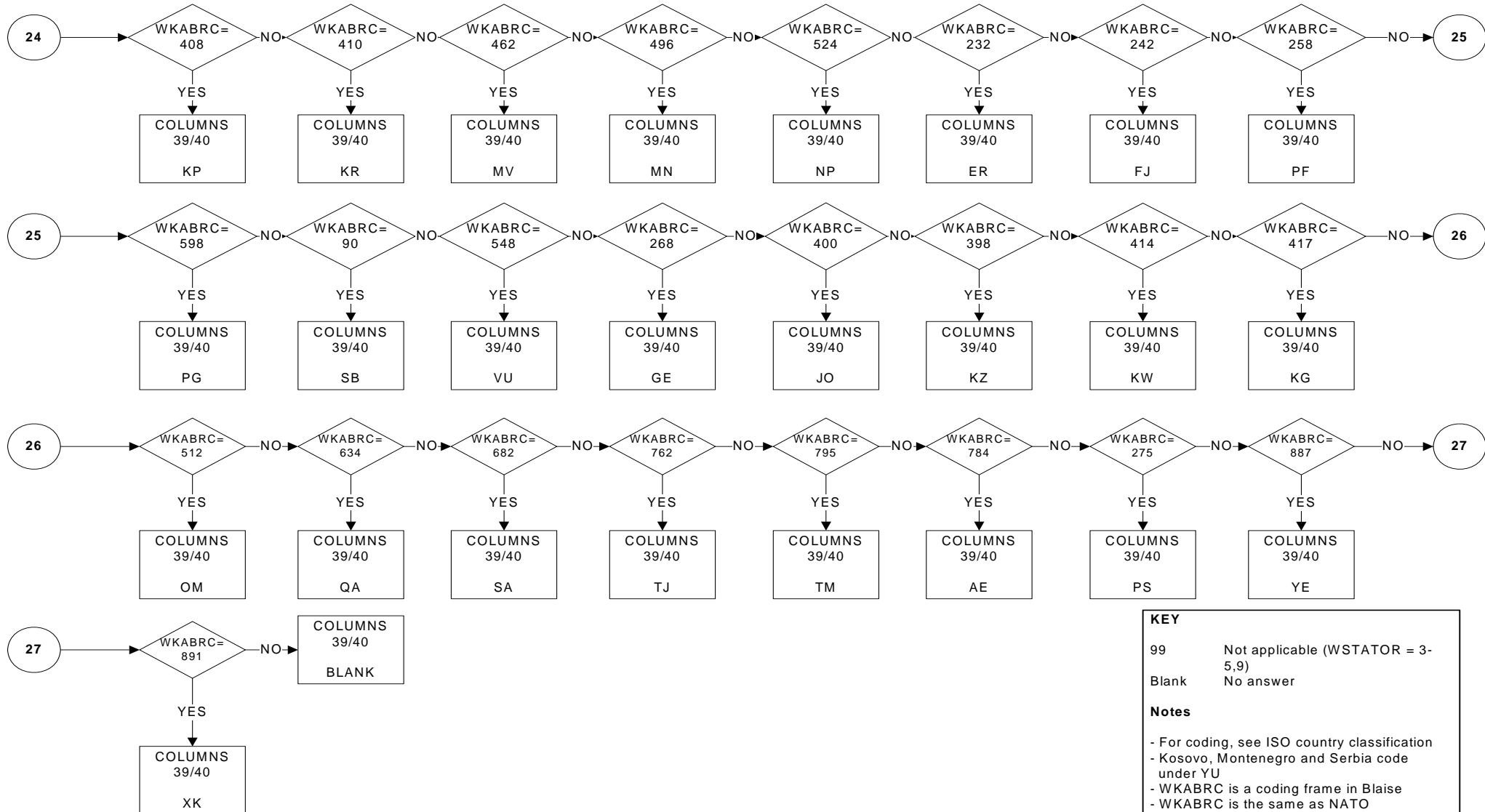

KEY

99 Not applicable (WSTATOR = 3-5,9)
Blank No answer

Notes

- For coding, see ISO country classification
- Kosovo, Montenegro and Serbia code under YU
- WKABRC is a coding frame in Blaise
- WKABRC is the same as NATO

REGIONW (EREGWKR): Region of place of work

Columns 41/42

PAGE 1 OF 5

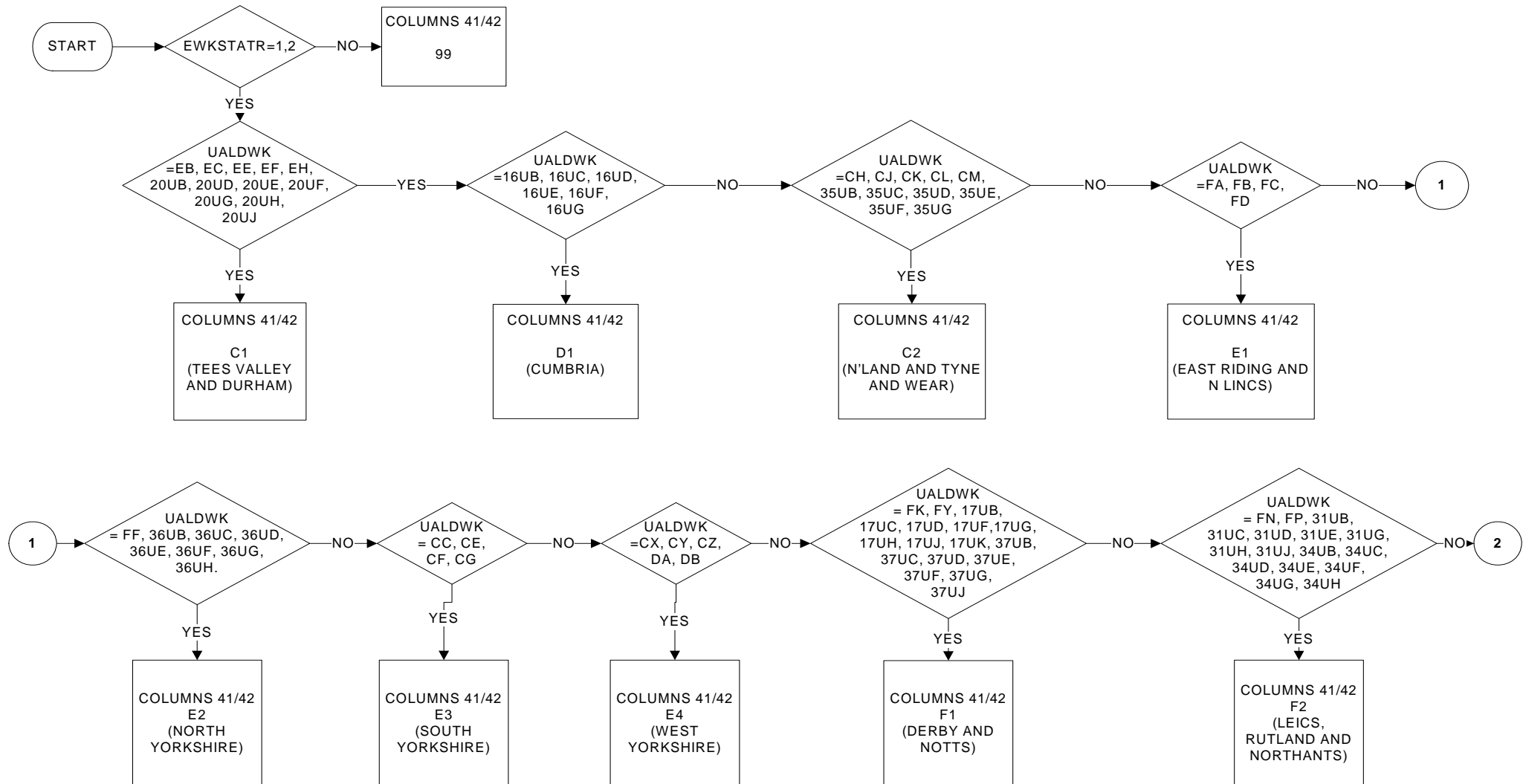

REGIONW (EREGWKR): Region of place of work

Columns 41/42

PAGE 2 OF 5

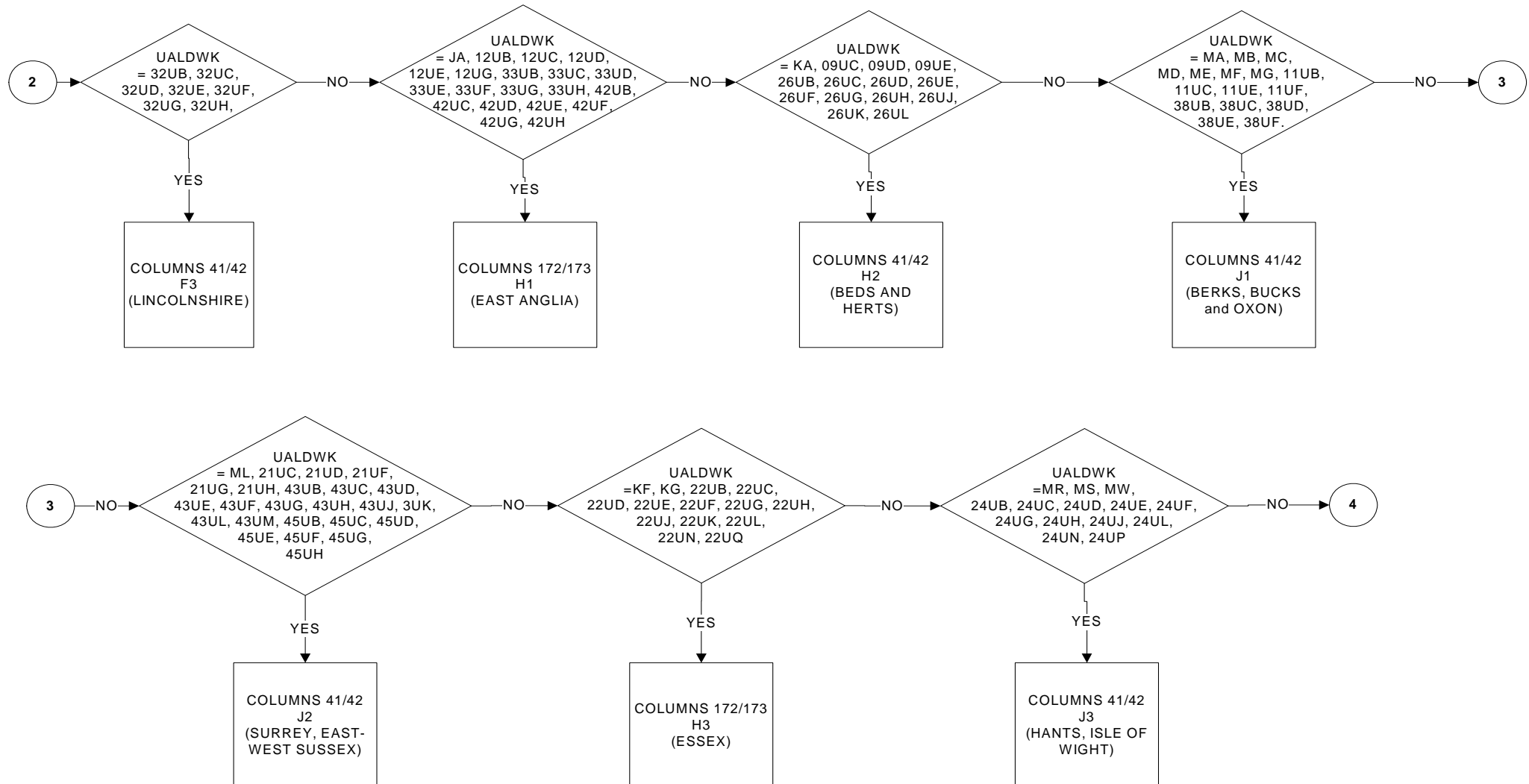

REGIONW (EREGWKR): Region of place of work

Columns 41/42

PAGE 3 OF 5

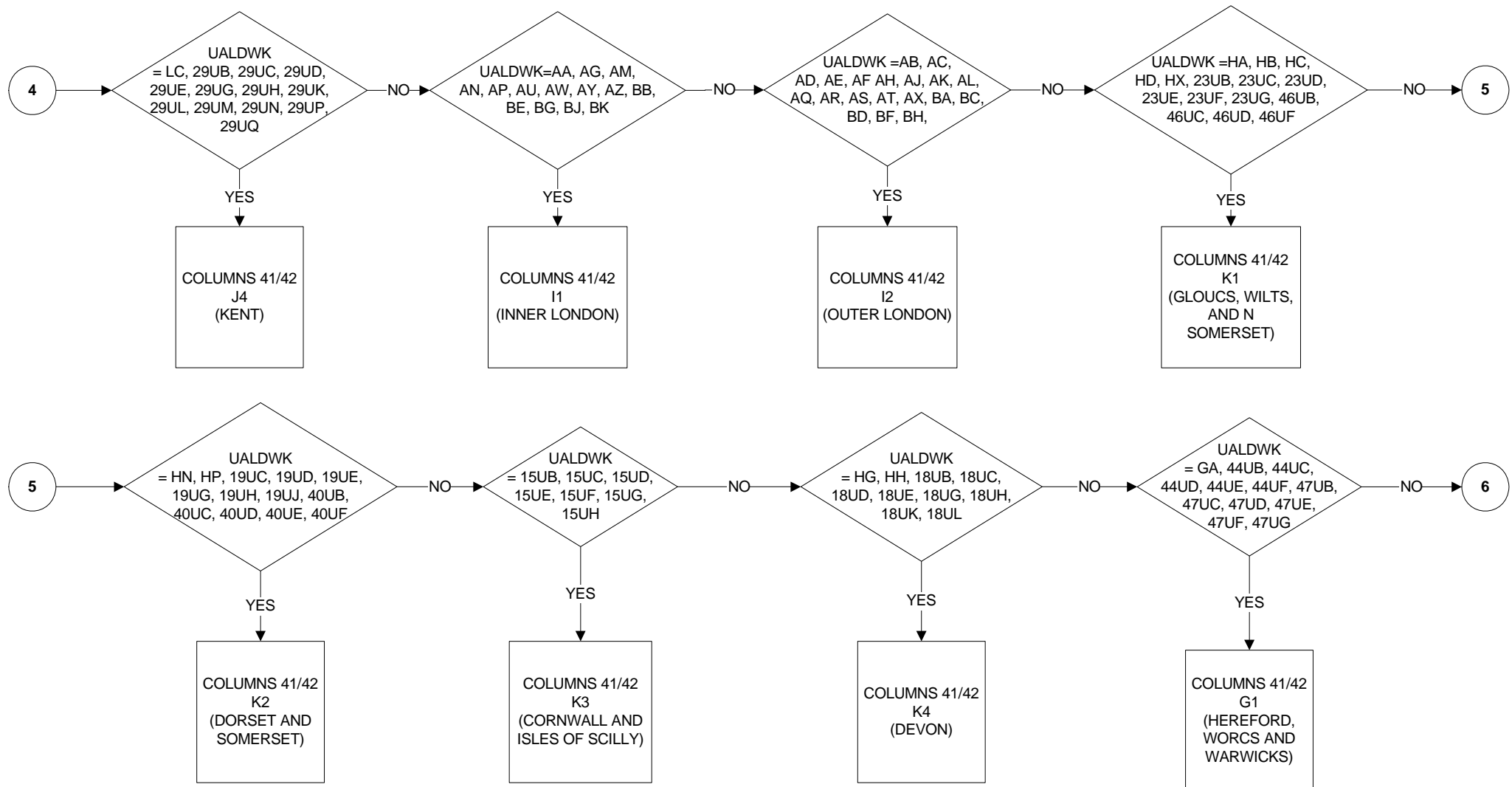

REGIONW (EREGWKR): Region of place of work

Columns 41/42

PAGE 4 OF 5

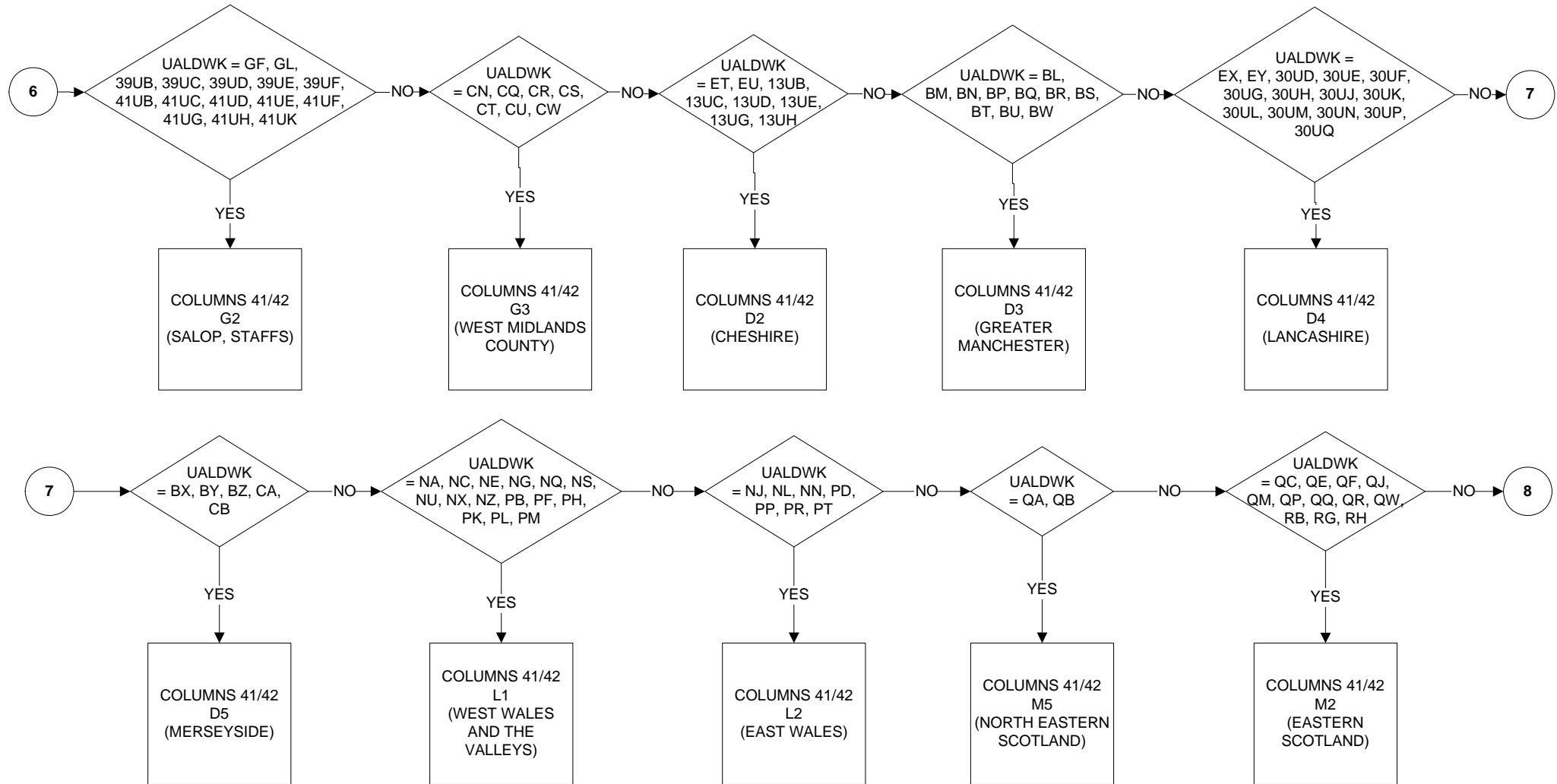

REGIONW (EREGWKR): Region of place of work

Columns 41/42

PAGE 5 OF 5

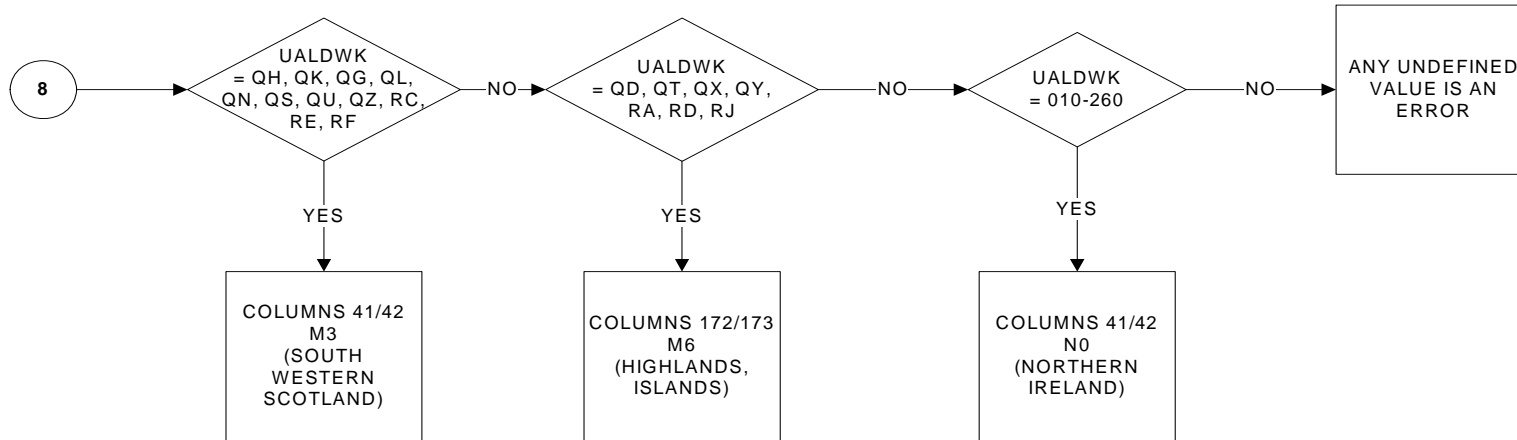

| KEY | |
|-------|----------------------------------|
| 99 | Not applicable (WSTATOR = 3-5,9) |
| blank | No answer |

YSTARTWK (EYRSTRTR): Year in which person started working for this employer or as self-employed

Columns 43/46

PAGE 1 OF 1

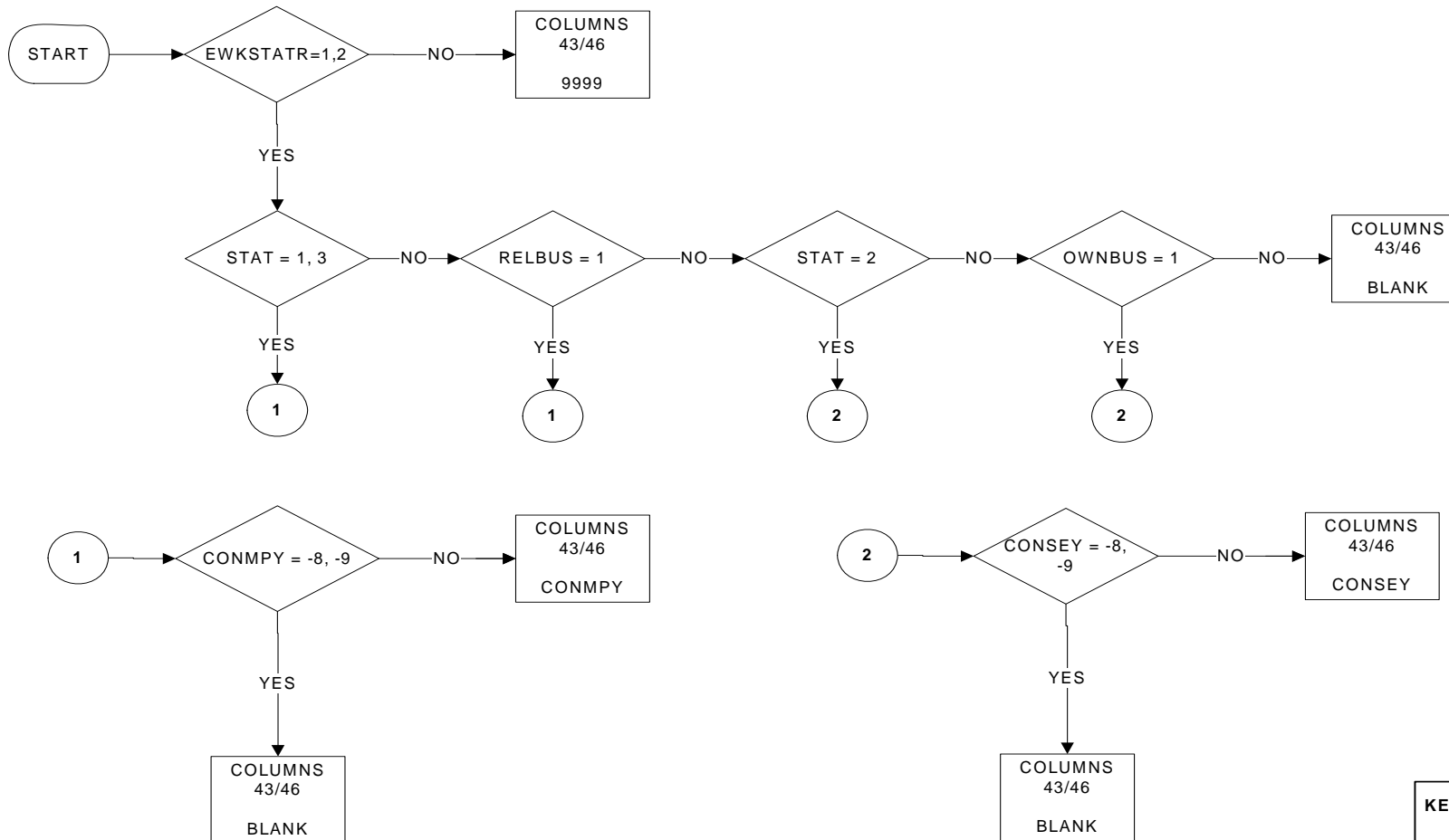

| KEY | |
|-------|--|
| | Enter the 4 digits of the year concerned |
| 9999 | Not applicable (WSTATOR = 3-5,9) |
| blank | No answer |

MSTARTWK (EMNSTRTR): Month started with current employer/self-employed

Columns 47/48

PAGE 1 OF 1

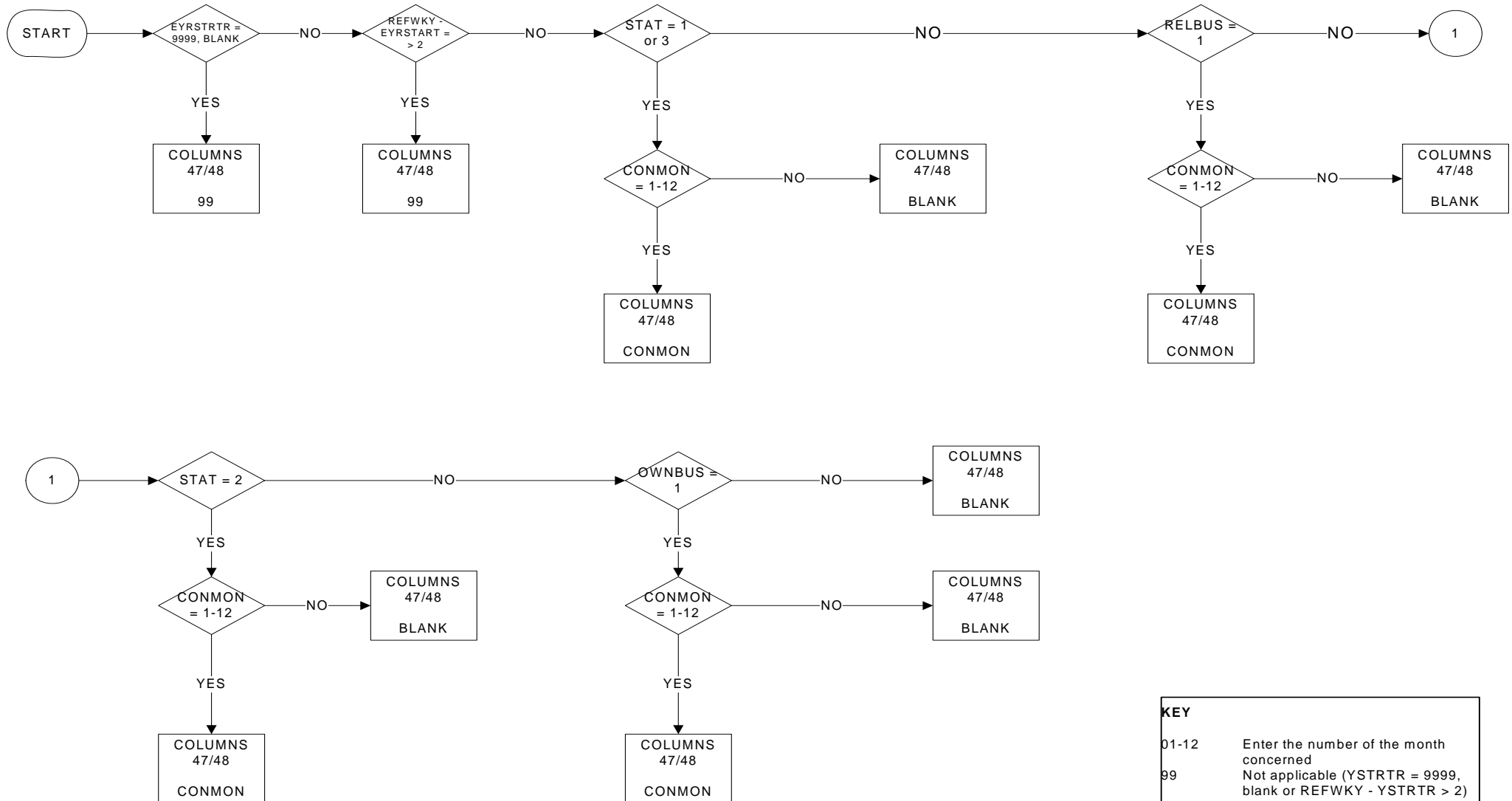

| KEY | |
|-------|--|
| 01-12 | Enter the number of the month concerned |
| 99 | Not applicable (YSTRTR = 9999, blank or REFWKY - YSTRTR > 2) |
| blank | No answer |

WAYJFOUN (EHOWGET): Involvement of the public employment office at any moment in finding the present job

Column 49

PAGE 1 OF 1

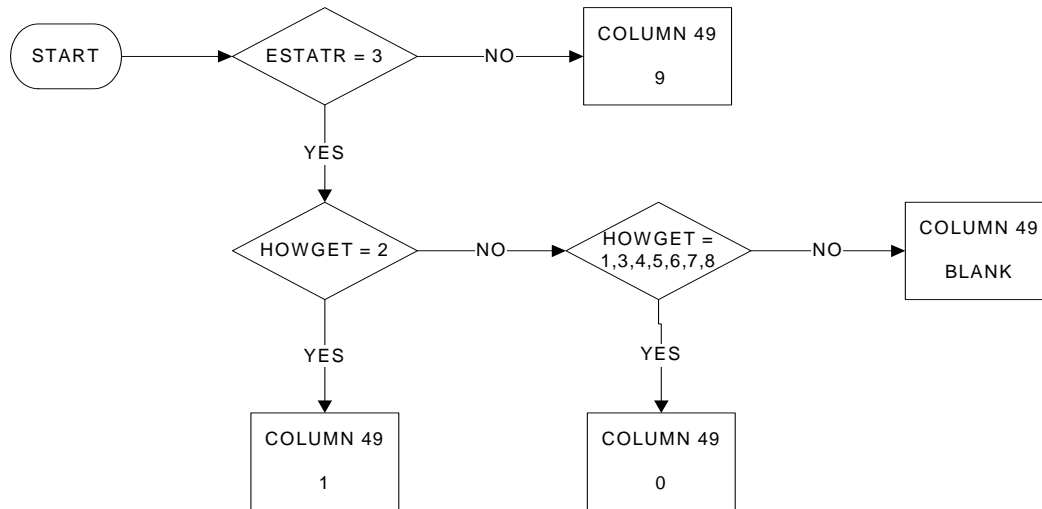

| KEY | |
|-------|--|
| 0 | No |
| 1 | Yes |
| 9 | Not Applicable (STAPRO is not equal to 3 or has started this job more than 1 year ago) |
| blank | No answer |

FTPT (EFTPTWKR): Full-time/part-time distinction

Column 50
PAGE 1 OF 1

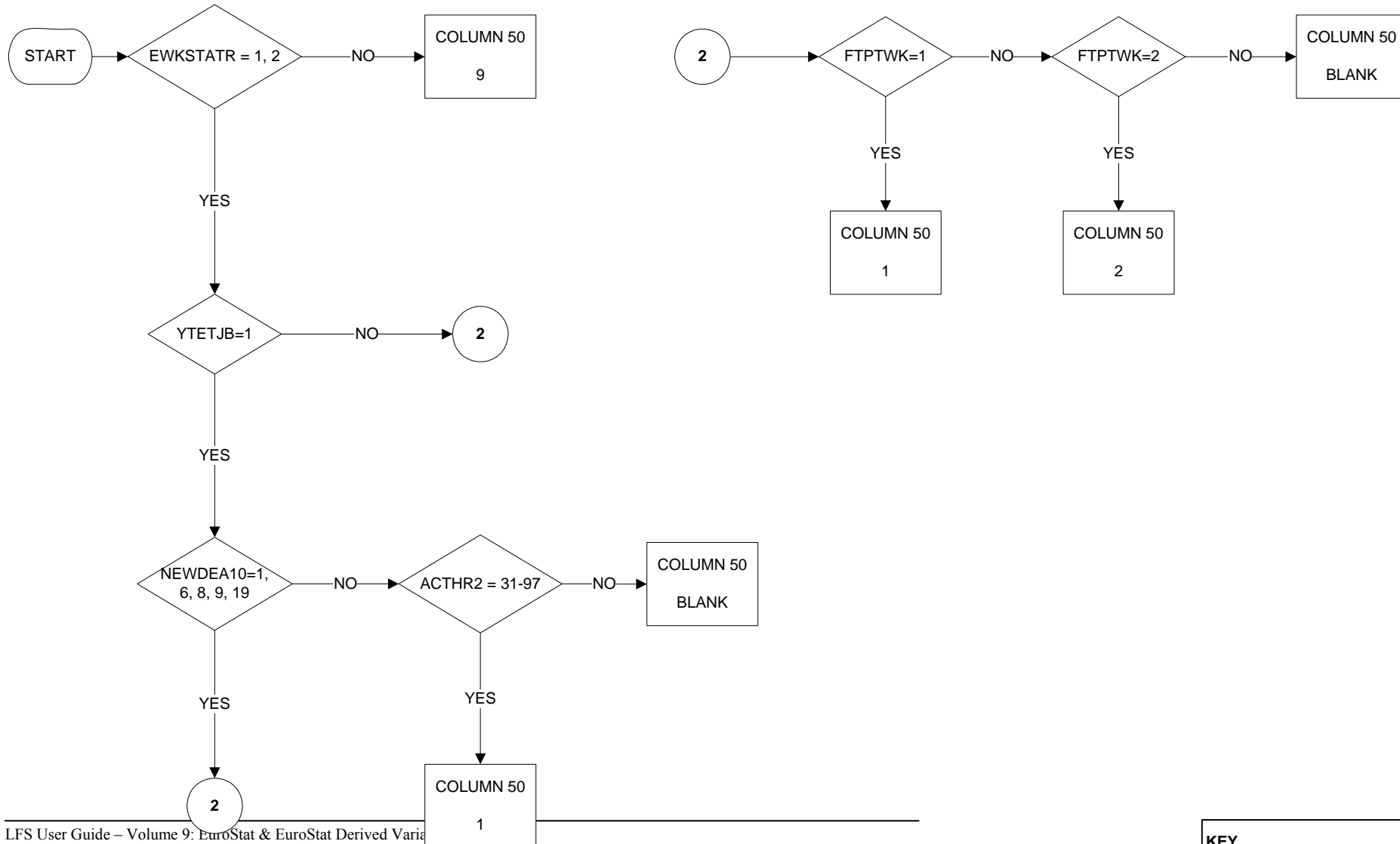

FTPTREAS (EYPTJOB): Reasons for part-time work

Column 51
PAGE 1 OF 1

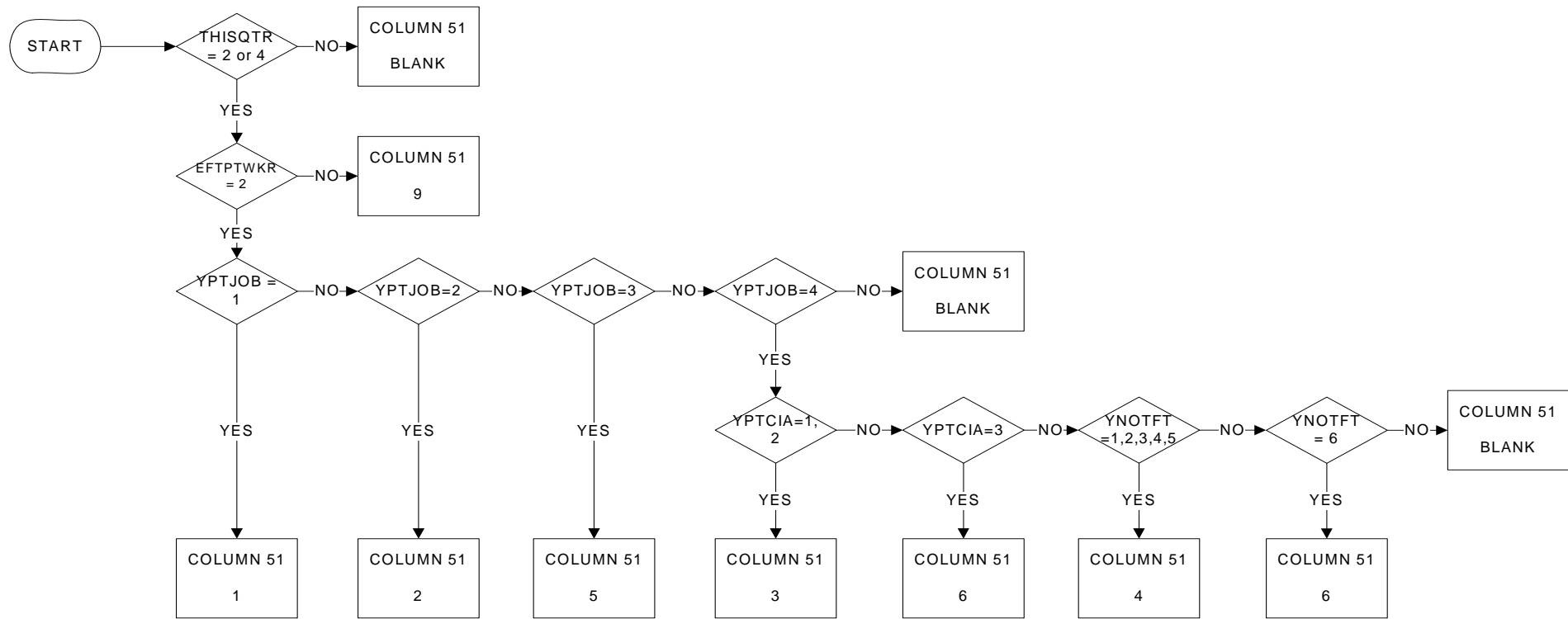

KEY

- 1 Person is undergoing school education or training
- 2 Of own illness or disability
- 3 Looking after children or incapacitated adults
- 4 Other personal or family reasons
- 5 Person could not find a full-time job
- 6 Of other reasons
- 9 Not applicable (FTPT ? 2)
- BLANK No answer

TEMP (EPERMR): Permanency of first job

Column 52

PAGE 1 OF 1

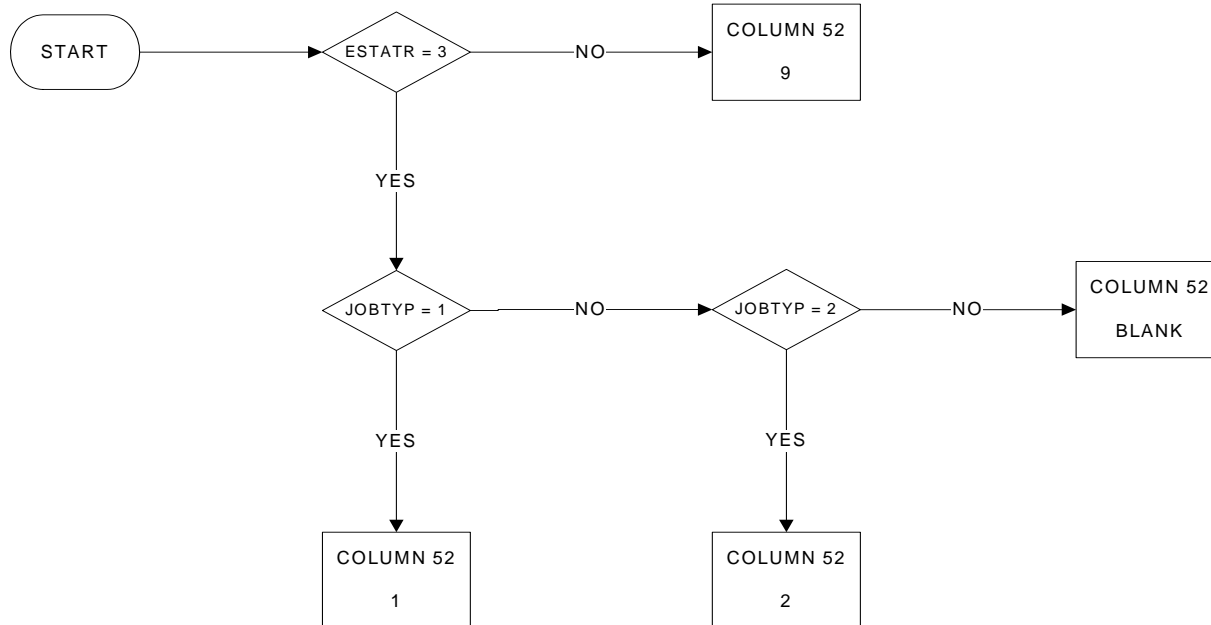

KEY

- 1 Person has a permanent job or work contract of unlimited duration
- 2 Person has temporary job/work contract of limited duration
- 9 Not applicable (ESTATR ? 3)
- Blank No answer

TEMPREAS (EWHYTMP): Reasons for having a temporary job/work contract of limited duration

Column 53

PAGE 1 OF 1

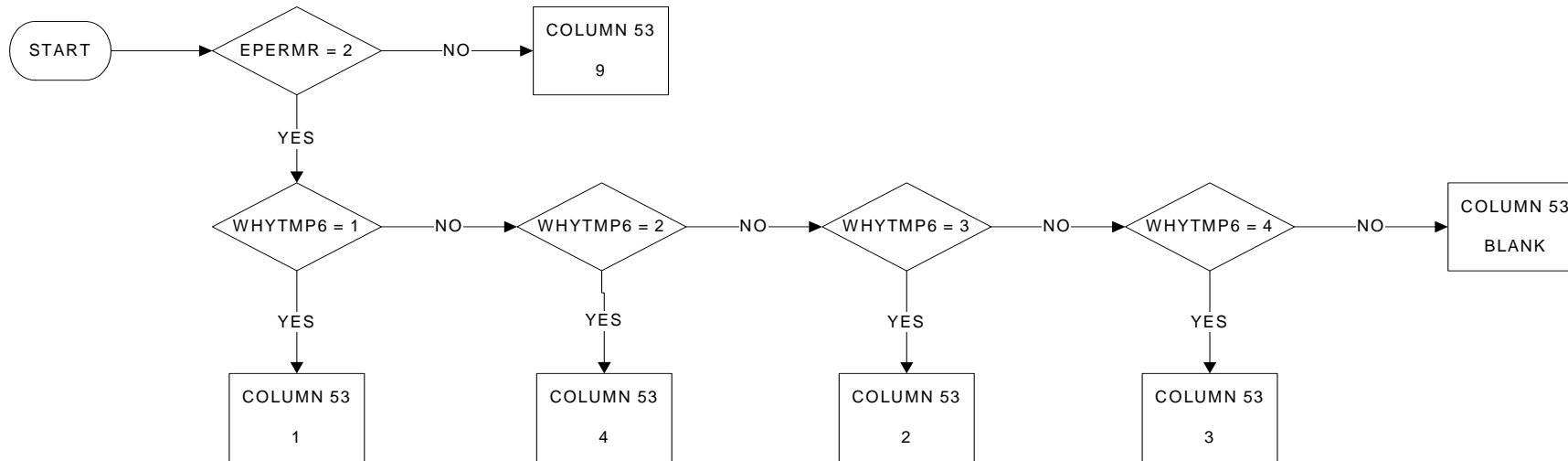

| KEY | |
|-------|---|
| 1 | It is a contract covering a period of training (apprentices, trainees, research assistants, etc.) |
| 2 | Person could not find a permanent job |
| 3 | Person did not want a permanent job |
| 4 | It is a contract for a probationary period |
| 9 | Not applicable (TEMP ? 2) |
| blank | No answer |

TEMPDUR (EDURTPR): Duration of temporary job

Column 54
PAGE 1 OF 1

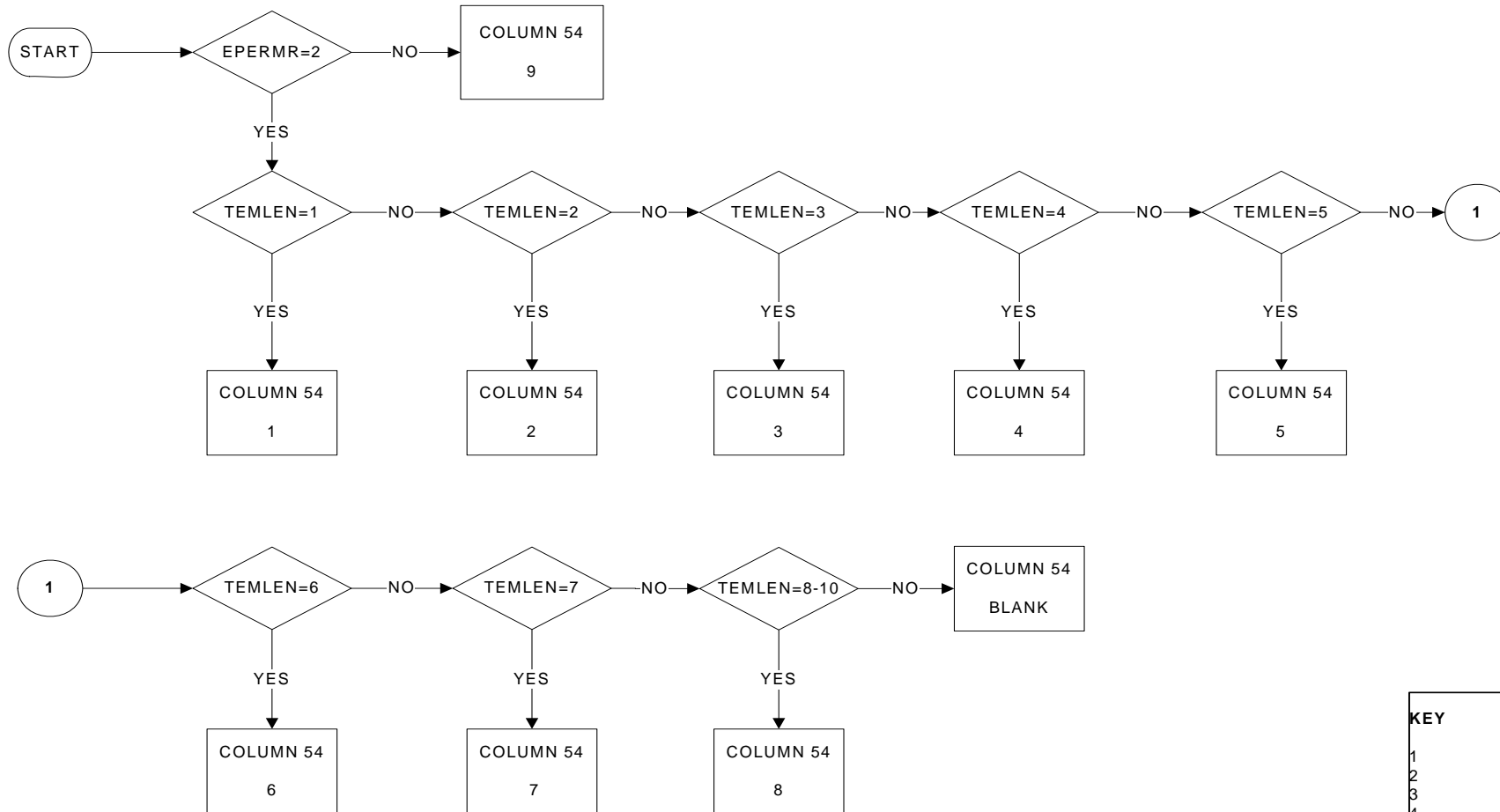

KEY

| | |
|-------|---|
| 1 | Less than one month |
| 2 | 1 to 3 months |
| 3 | 4 to 6 months |
| 4 | 7 to 12 months |
| 5 | 13 to 18 months |
| 6 | 19 to 24 months |
| 7 | 25 to 36 months |
| 8 | More than 3 years |
| 9 | Not applicable (TEMP is not equal to 2) |
| Blank | No answer |

TMPAGCY (ETMPCON): Contract with a temporary employment agency

Column 55

PAGE 1 OF 1

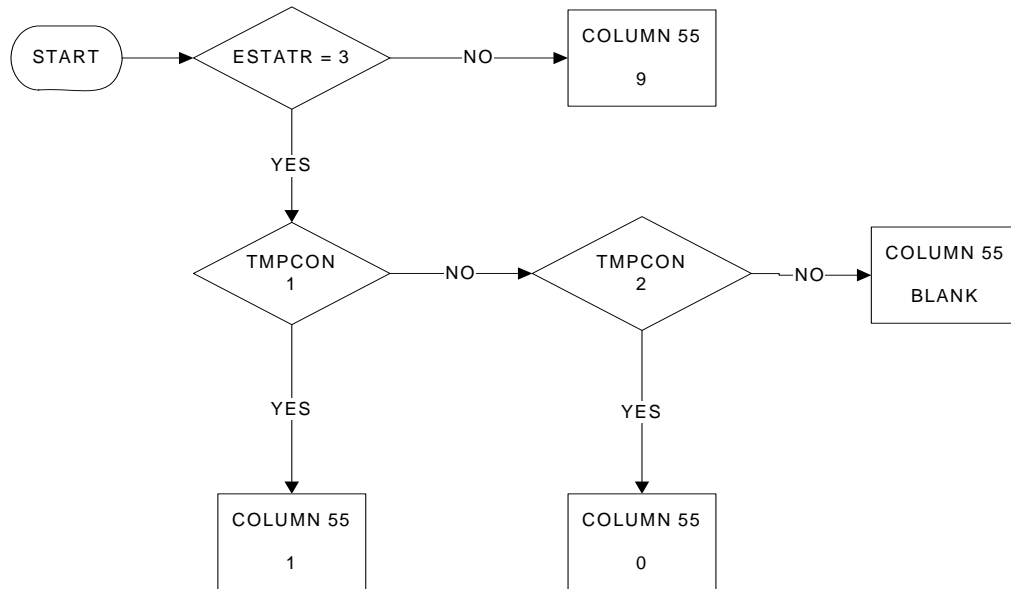

| KEY | |
|-------|-----------------------------|
| 0 | No |
| 1 | Yes |
| 9 | Not applicable (STAPRO ? 3) |
| blank | No answer |

SHIFTWK (ESHIFTR): Shift work

Column 56
PAGE 1 OF 1

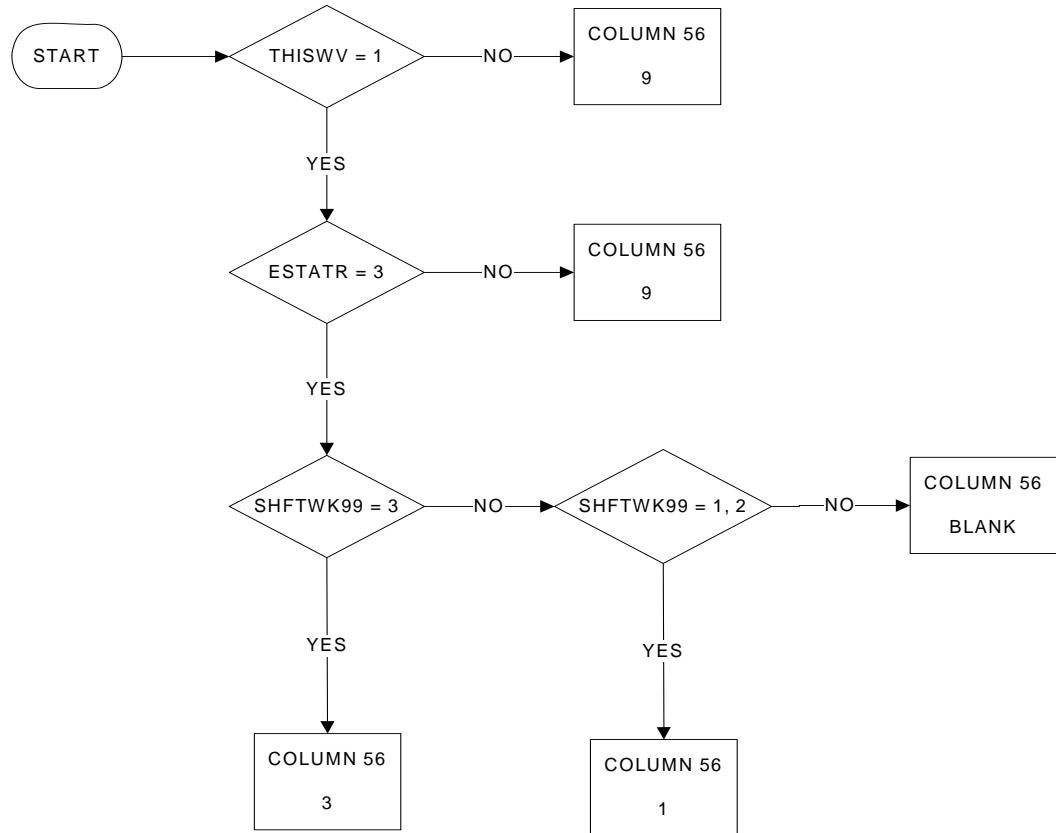

| KEY | |
|-------|------------------------------|
| 1 | Person does shift work |
| 3 | Person never does shift work |
| 9 | Not applicable (STAPRO ? 3) |
| Blank | No answer |

EVENWK (EEVENR): Evening work in main job

Column 57
PAGE 1 OF 1

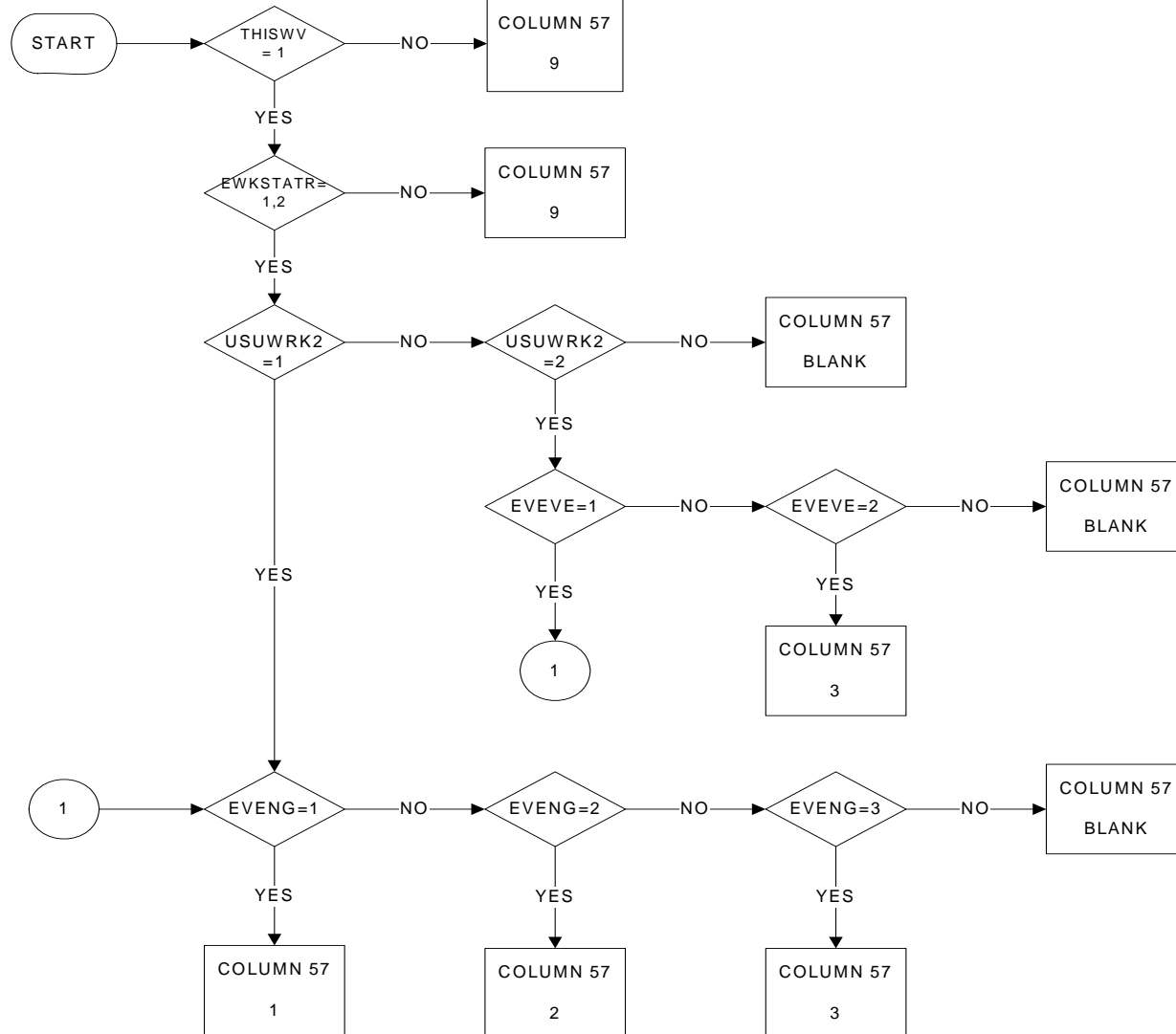

| KEY | |
|-------|---------------------------------------|
| 1 | Person usually works in the evening |
| 2 | Person sometimes works in the evening |
| 3 | Person never works in the evening |
| 9 | Not applicable (WSTATOR = 3-5,9) |
| BLANK | No Answer |

NIGHTWK (ENIGHTR): Night work in main job

Column 58
PAGE 1 OF 1

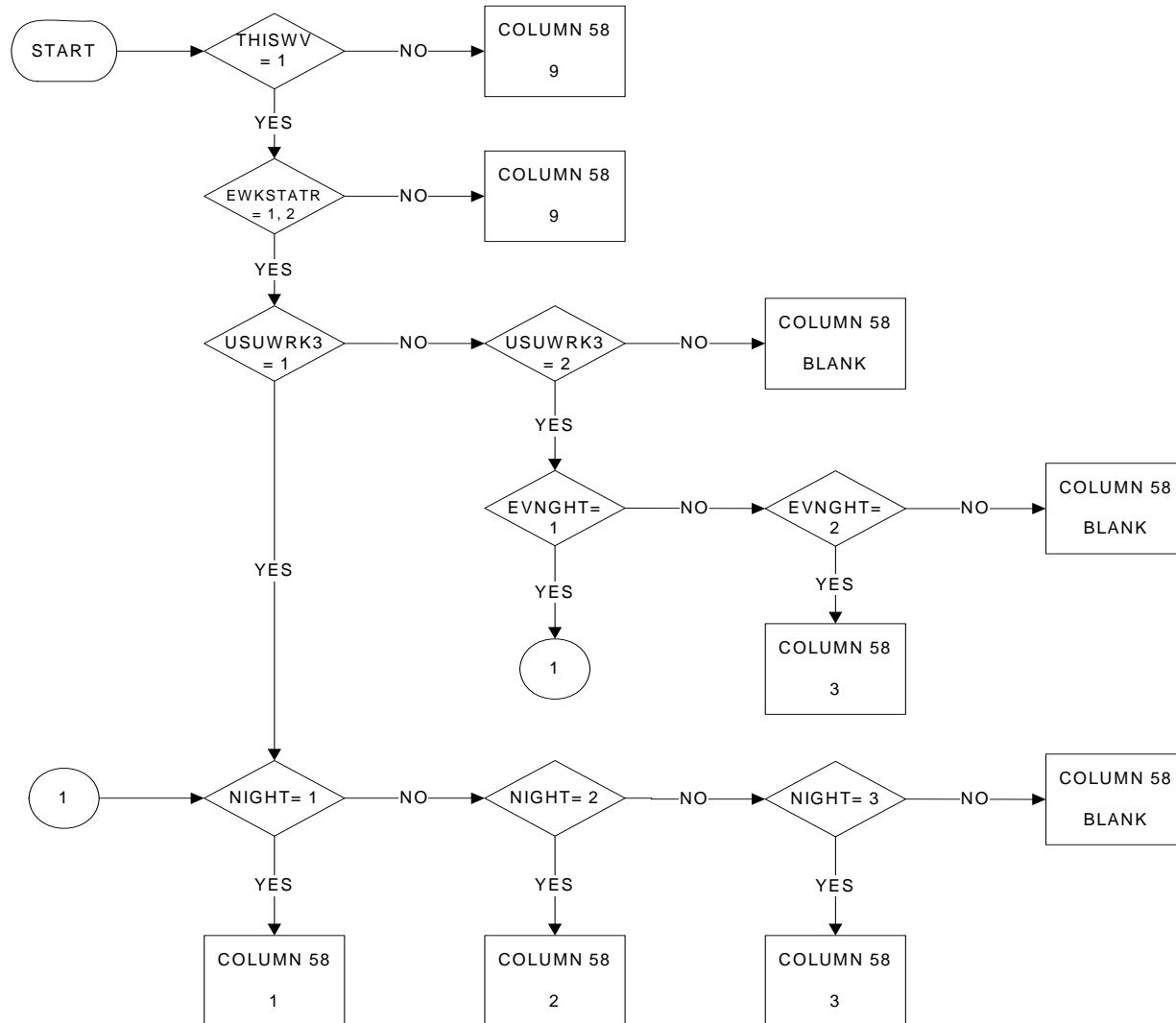

| KEY | |
|-------|----------------------------------|
| 1 | Person usually works at night |
| 2 | Person sometimes works at night |
| 3 | Person never works at night |
| 9 | Not applicable (WSTATOR = 3-5,9) |
| BLANK | No Answer |

SATWK (ESATR): Saturday work in main job
 Column 59
 PAGE 1 OF 1

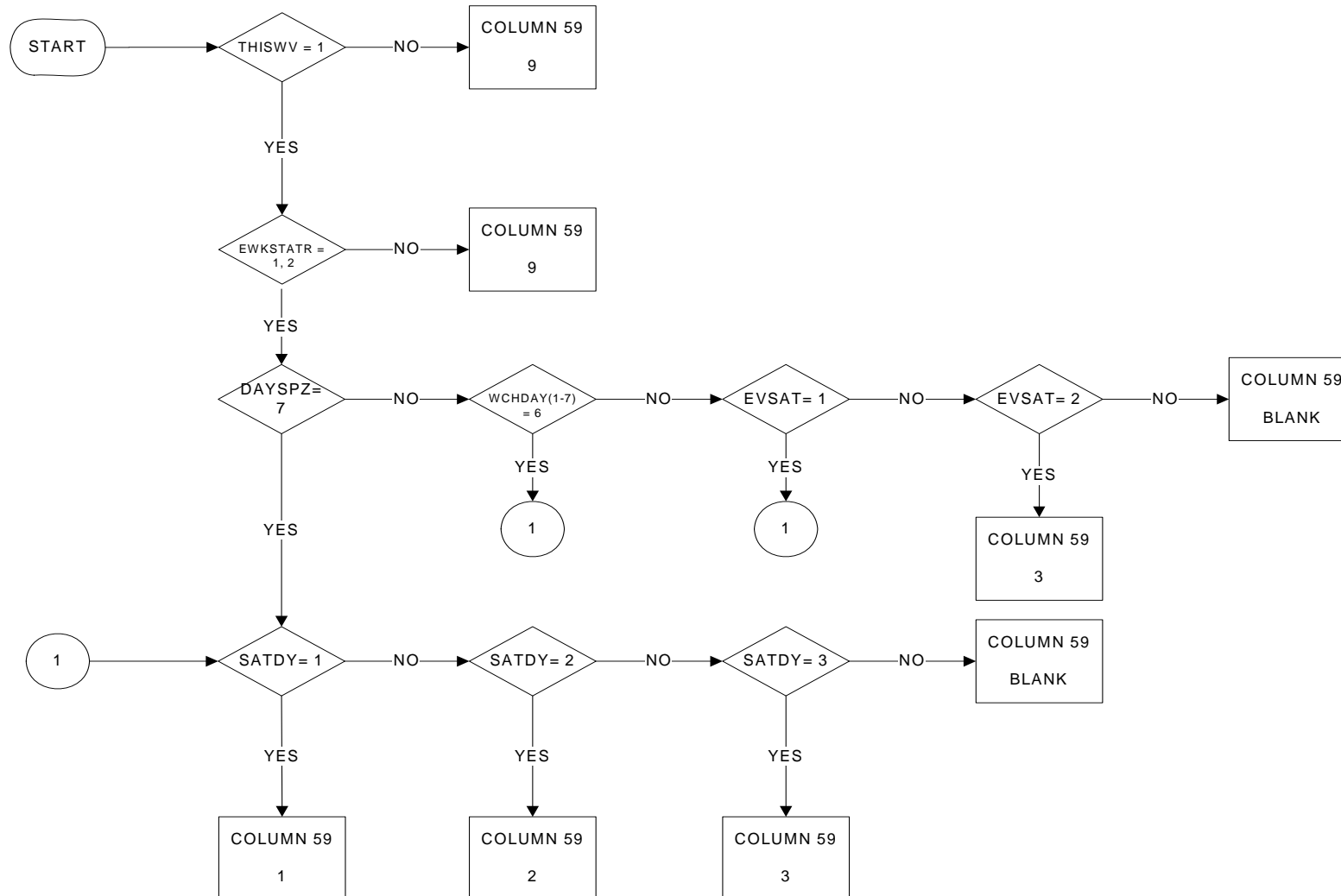

| KEY | |
|-------|-------------------------------------|
| 1 | Person usually works on Saturdays |
| 2 | Person sometimes works on Saturdays |
| 3 | Person never works on Saturdays |
| 9 | Not applicable (WSTATOR = 3-5,9) |
| Blank | No Answer |

SUNWK (ESUNR): Sunday work

Column 60
PAGE 1 OF 1

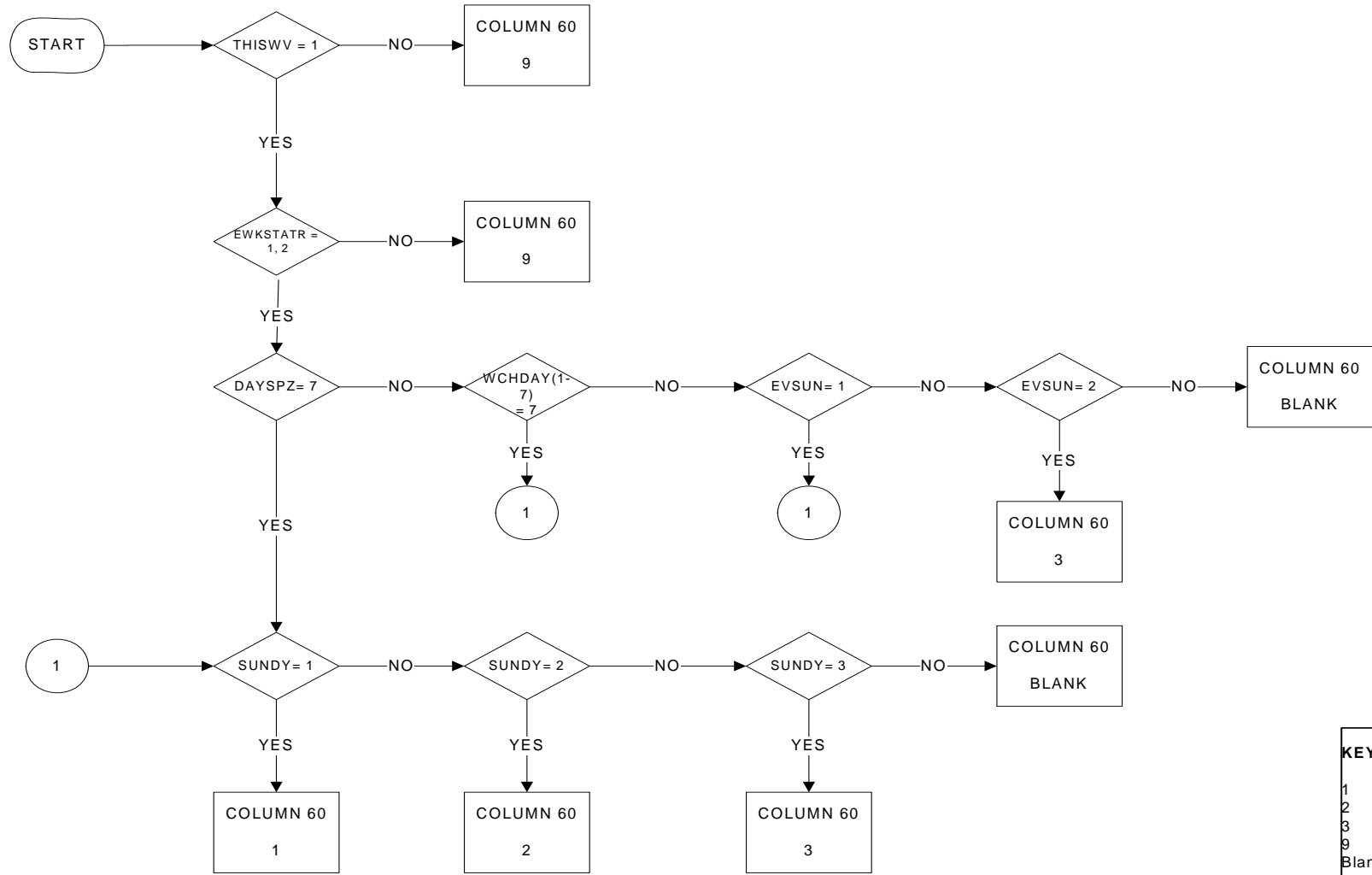

| KEY | |
|-------|-----------------------------------|
| 1 | Person usually works on Sundays |
| 2 | Person sometimes works on Sundays |
| 3 | Person never works on Sundays |
| 9 | Not applicable (WSTATOR = 3-5,9) |
| Blank | No Answer |

HWUSUAL (EUSUHR): Number of hours usually worked in main job

Columns 61/62

PAGE 1 OF 1

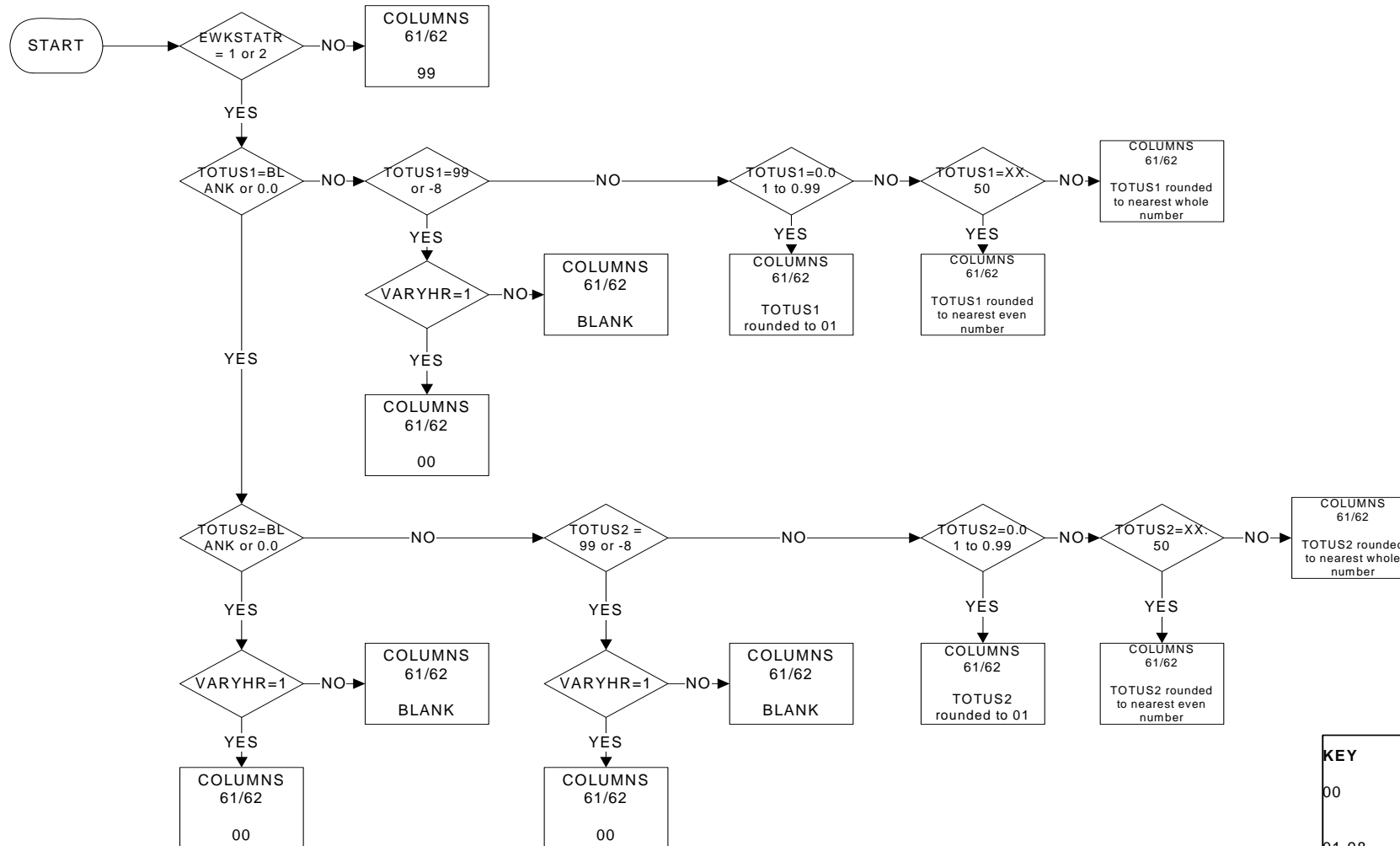

KEY

- 00 Usual hours cannot be given because hours worked vary considerably from week to week or from month to month
- 01-98 Number of hours usually worked in the main job
- 99 Not applicable (WSTATOR = 3-5, 9)
- BLANK No answer

HWACTUAL (EACTHRR): Number of hours actually worked during reference week in main job

Columns 63/64

PAGE 1 OF 1

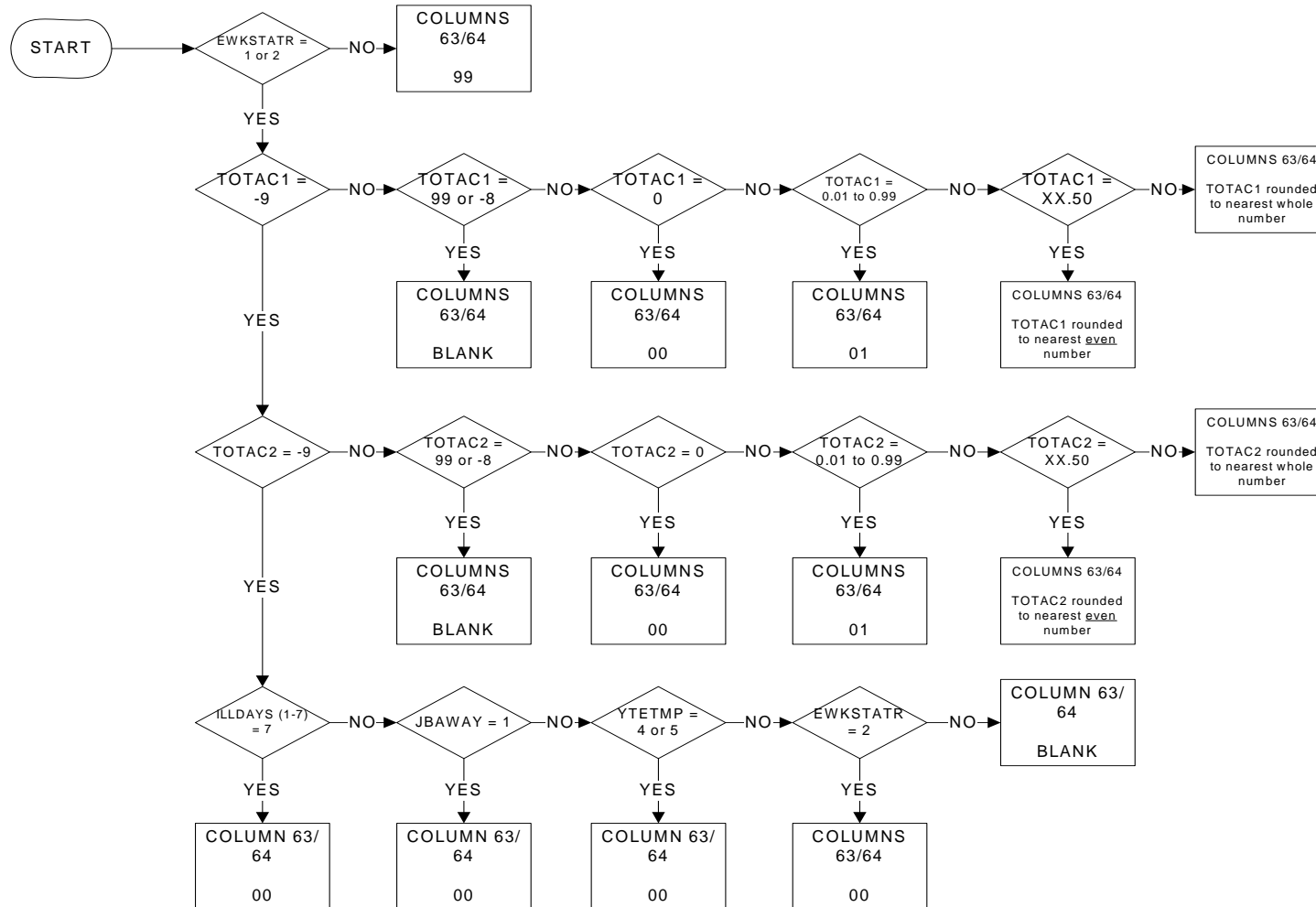

KEY

- 00 Person having a job or business and not having worked at all in the main activity during the reference week
- 01-98 Number of hours actually worked in the main job during the reference week
- 99 Not applicable (WSTATOR = 3-5 or 9)
- Blank No answer

Notes

XX is a number in the range 01 to 97. Unbiased rounding is used; so instead of always rounding up, we will round up if the number is odd, and down if the number is even.

HWOVERP (EACTPOT): Paid overtime in the reference week in the main job

Column 65/66

PAGE 1 OF 1

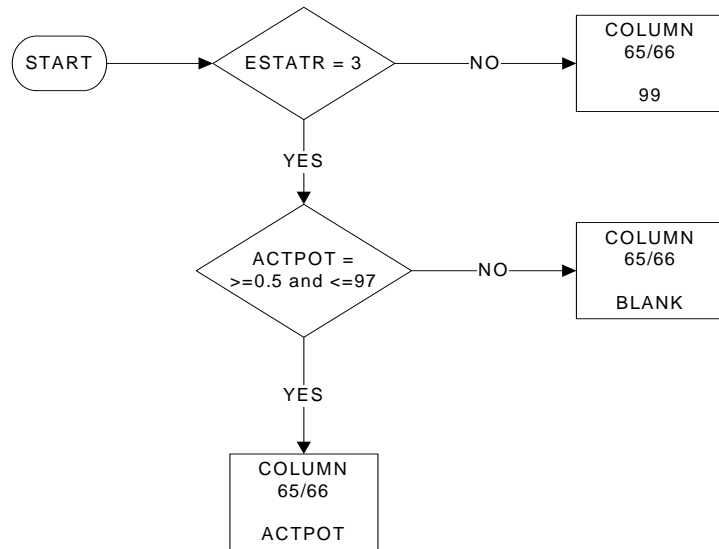

| KEY | |
|-------|---|
| 00-98 | Number of paid overtime hours |
| 99 | Not applicable (STAPRO is not equal to 3) |
| BLANK | No answer |

HWOVERPU (EACTUOT): Unpaid overtime in the reference week in the main job

Columns 67/68

PAGE 1 OF 1

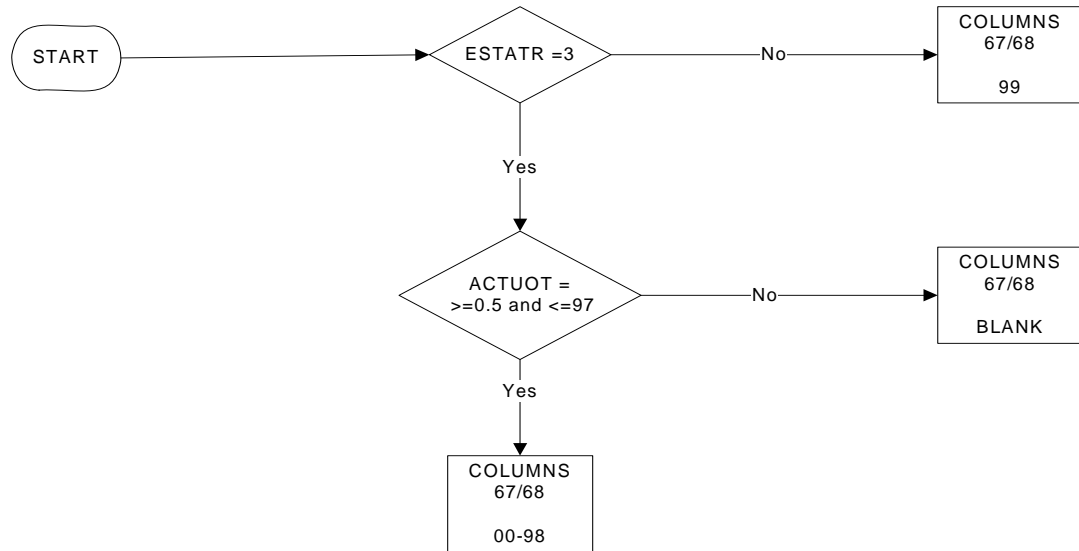

KEY

| | |
|---------|---------------------------------|
| 00 - 98 | Number of unpaid overtime hours |
| 99 | Not Applicable (STAPRO = 3) |
| BLANK | No answer |

HOURREAS (EWHYDIFR): Main reason why hours actually worked differed from usual hours

Columns 69/70

PAGE 1 OF 2

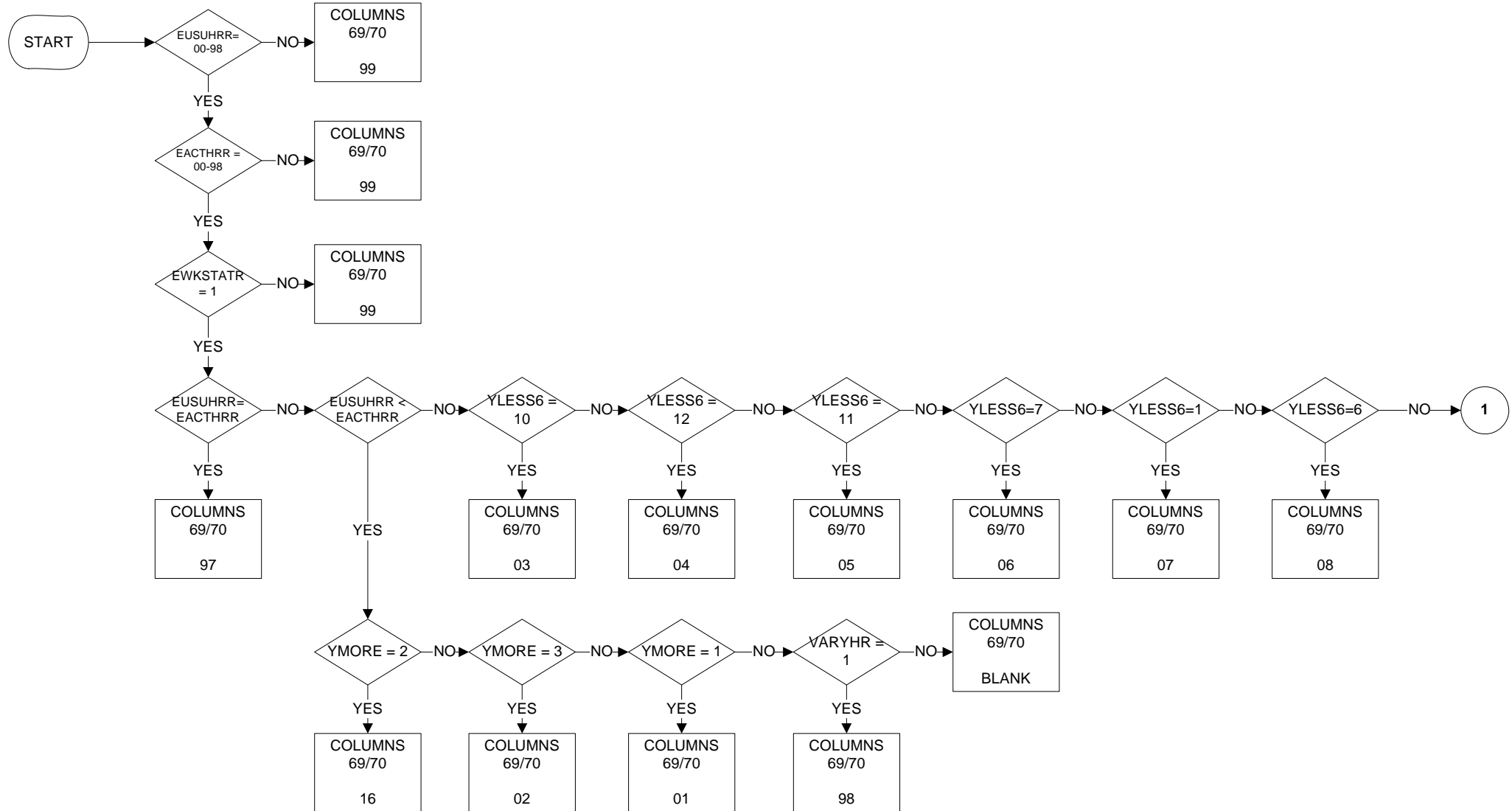

HOURREAS (EWHYDIFR): Main reason why hours actually worked differed from usual hours

Columns 69/70

PAGE 2 OF 2

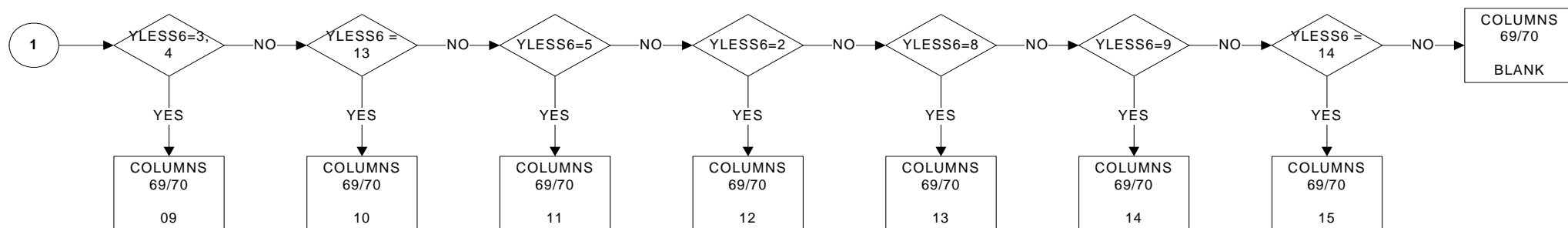

KEY

- 01 *Person has worked more than usual due to:*
- 01 Variable hours (e.g. flexible working hours)
- 16 Overtime
- 02 Other reasons
- Person has worked less than usual due to:*
- 03 Bad weather
- 04 Slack work for technical or economic reasons
- 05 Labour dispute
- 06 Education or training
- 07 Variable hours (e.g. flexible working hours)
- 08 Own illness, injury or temporary disability
- 09 Maternity or parental leave
- 10 Special leave for personal or family reasons
- 11 Annual holidays
- 12 Bank holidays
- 13 Start of/change in job during reference week
- 14 End of job without taking up a new one during reference week
- 15 Other reasons
- 97 Person having worked usual hours during the reference week (HWUSUAL = HWACTUAL = 01-98)
- 98 Person whose hours vary considerably from week to week or month to month and who did not state a reason for a divergence between the actual and usual hours (HWUSUAL = 00 & HOURREAS # 01-16)
- 99 Not applicable (WSTATOR = 2-5,9 or HWUSUAL = blank or HWACTUAL = blank)
- BLANK No answer

WISHMORE (EMHRSR): Wish to work usually more than the current numbers of hours

Column 71
PAGE 1 OF 1

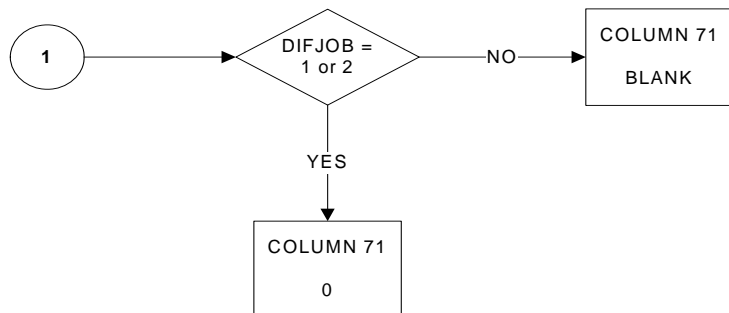
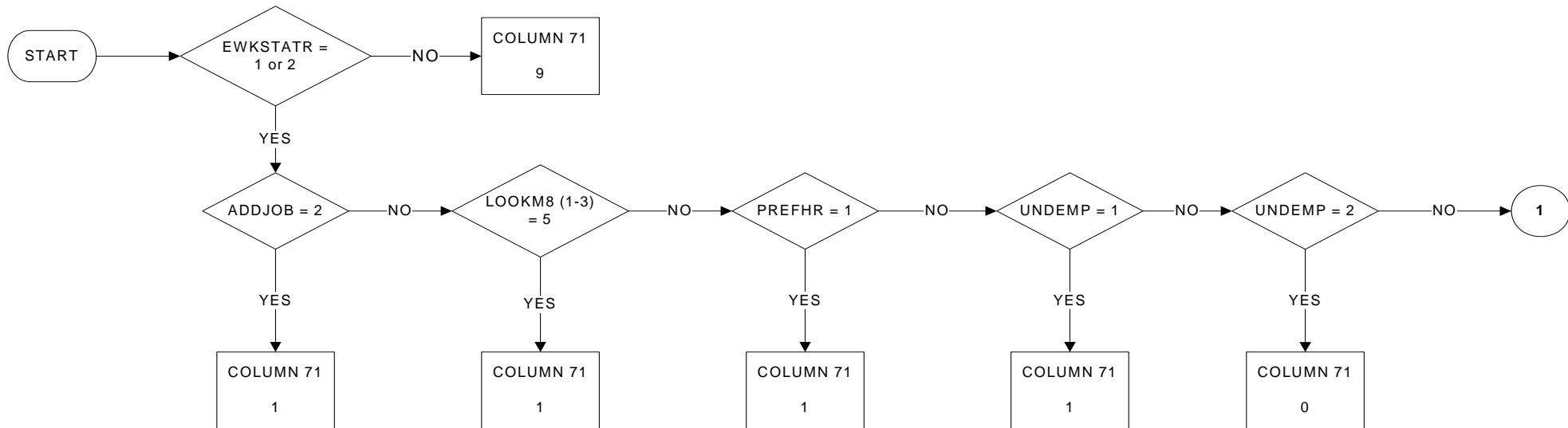

| KEY | |
|-------|-----------------------------------|
| 0 | No |
| 1 | Yes |
| 9 | Not applicable (WSTATOR = 3-5, 9) |
| Blank | No answer |

WAYMORE (EWAYHRS): Way that a person can work more hours

Column 72

PAGE 1 OF 1

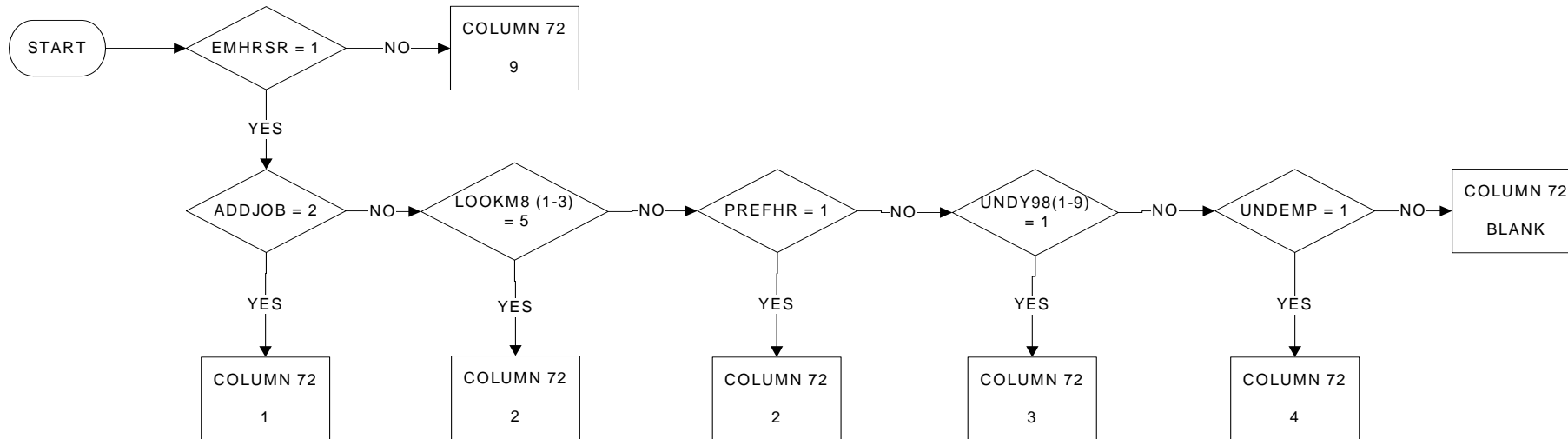

KEY

- 1 Through an additional job
- 2 Through a job working more hours than the present job
- 3 Only within the present job
- 4 In any of the above ways
- 9 Not applicable (WISHMORE ? 1)
- BLANK No Answer

HWWISH (ENUMHRSR): Number of hours would like to work in total

Columns 73/74

PAGE 1 OF 1

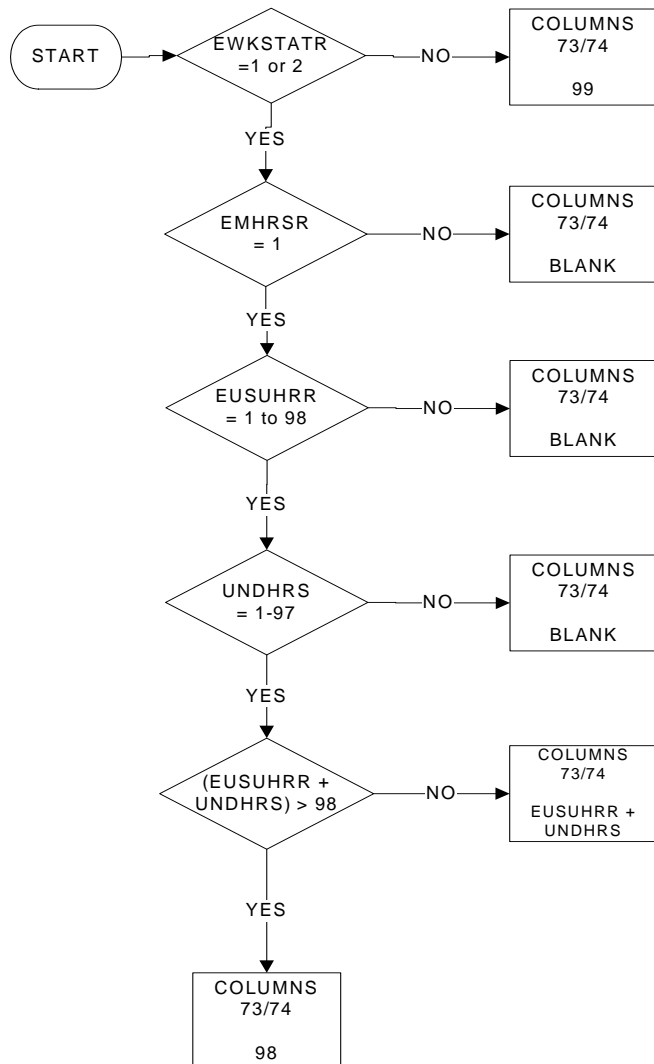

| KEY | |
|---------|---|
| 01 - 98 | Number of hours wished to work in total |
| 99 | Not applicable (WSTATOR = 3-5,9) |
| BLANK | No answer |

HOMEWK (EHOMER): Working at home in the first job

Column 75
PAGE 1 OF 1

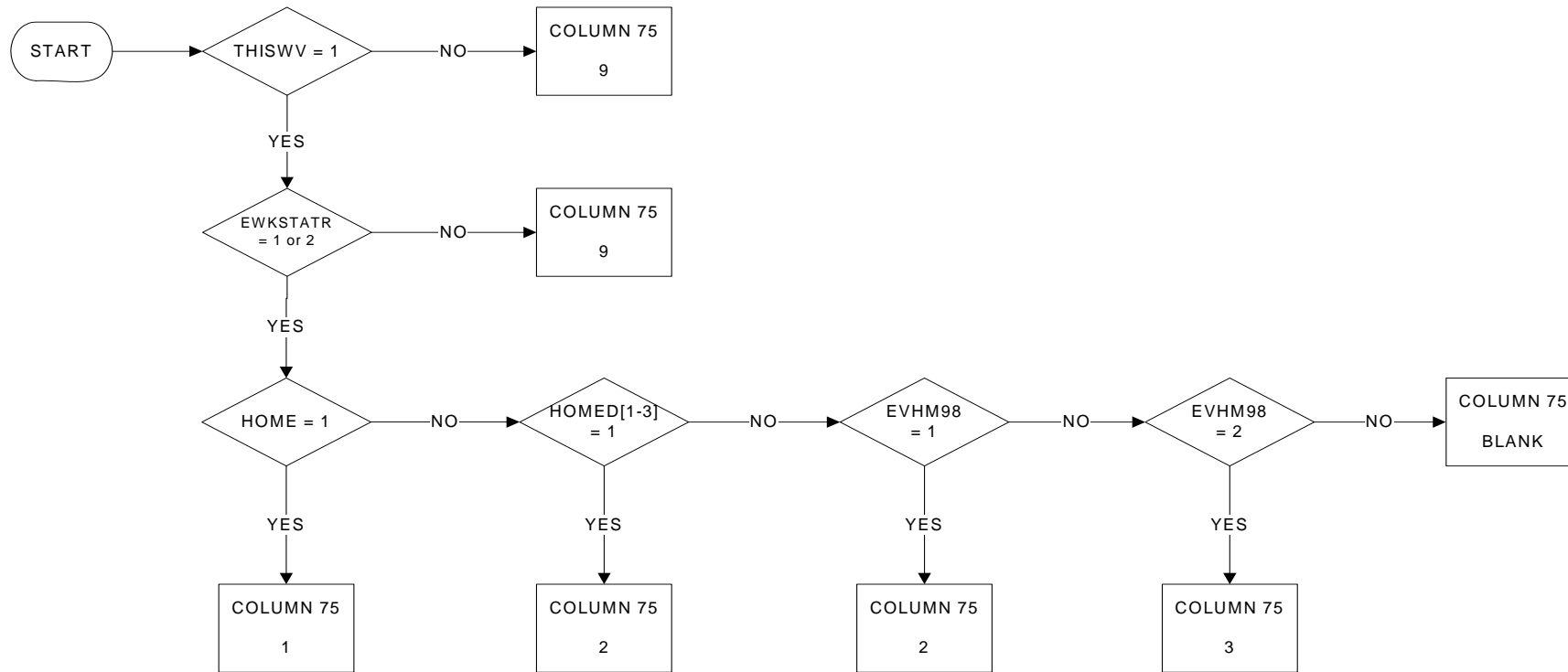

| KEY | |
|-------|--------------------------------------|
| 1 | Person usually works at home |
| 2 | Person sometimes works at home |
| 3 | Person never works at home |
| 9 | Not applicable (WSTATOR = 3-5 or 9) |
| Blank | No Answer |

LOOKOJ (EADDWKR): Looking for another job

Column 76

PAGE 1 OF 1

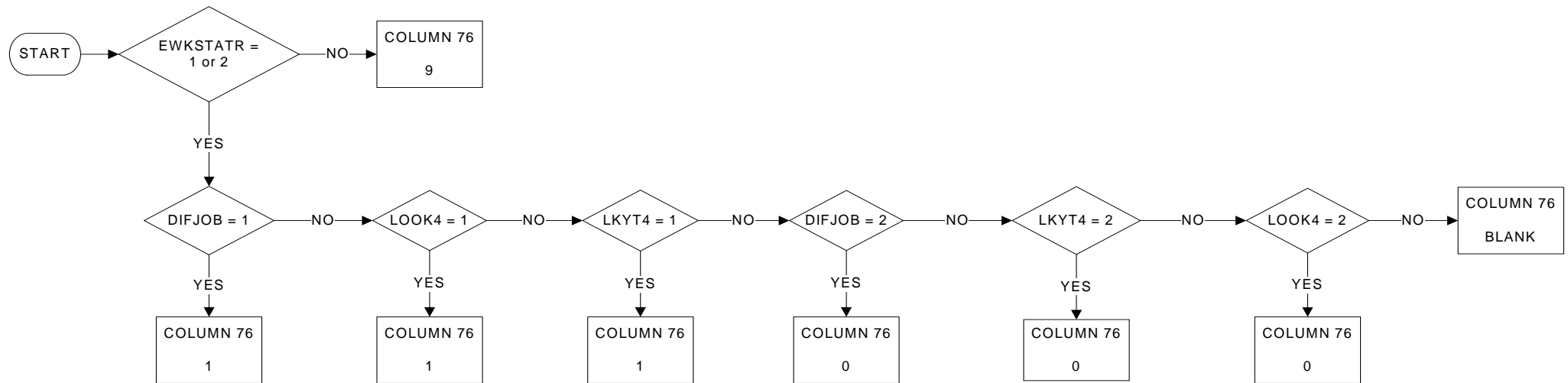

| KEY | |
|-------|---------------------------------------|
| 0 | Person is not looking for another job |
| 1 | Person is looking for another job |
| 9 | Not applicable (WSTATOR = 3-5, 9) |
| BLANK | No answer |

LOOKREAS (EADDREA): Reasons for looking for another job

Column 77
PAGE 1 OF 1

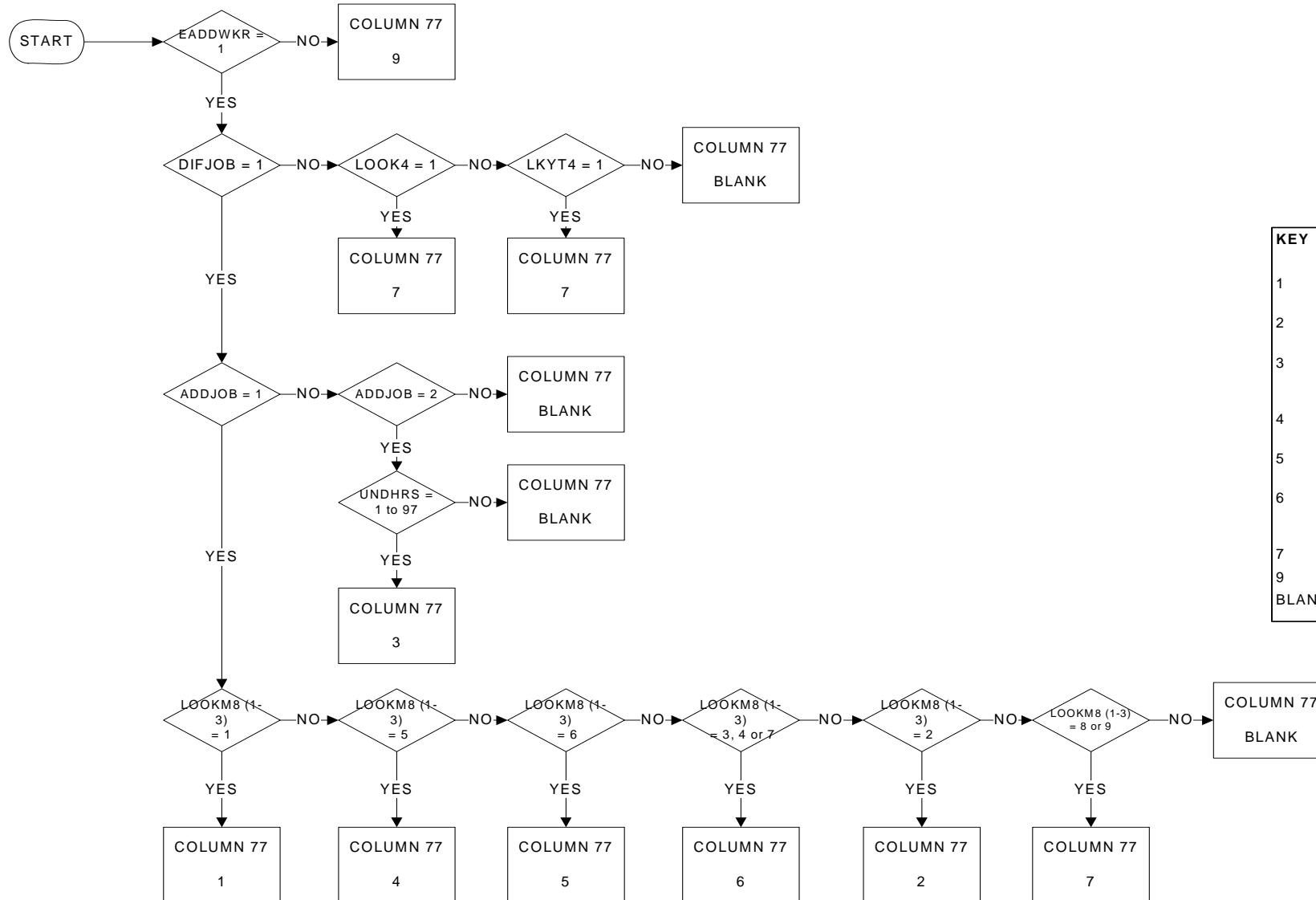

| KEY | |
|-------|--|
| 1 | Risk or certainty of loss or termination of present job |
| 2 | Actual job is considered as a transitional job |
| 3 | Seeking an additional job to add more hours to those worked in present job |
| 4 | Seeking a job with more hours worked than in present job |
| 5 | Seeking a job with less hours worked than in present job |
| 6 | Wish to have better working conditions (e.g. pay, working or travel time, quality of work) |
| 7 | Other reasons |
| 9 | Not applicable (LOOKOJ ? 1) |
| BLANK | No answer |

EXIST2J (ESECJOB): Existence of more than one job or business
 Column 78
 PAGE 1 OF 1

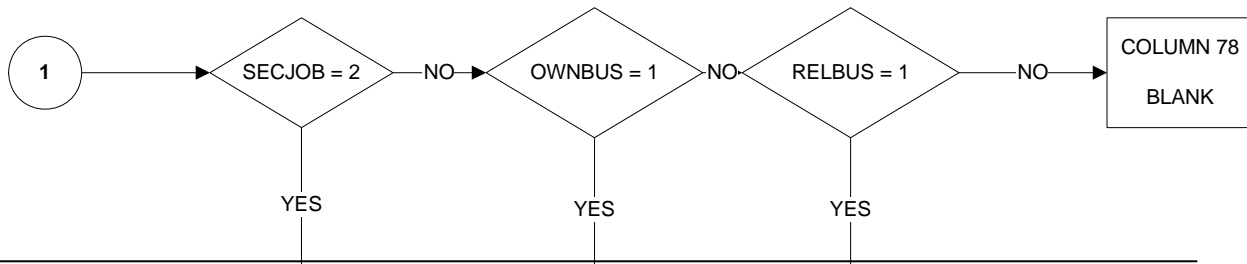
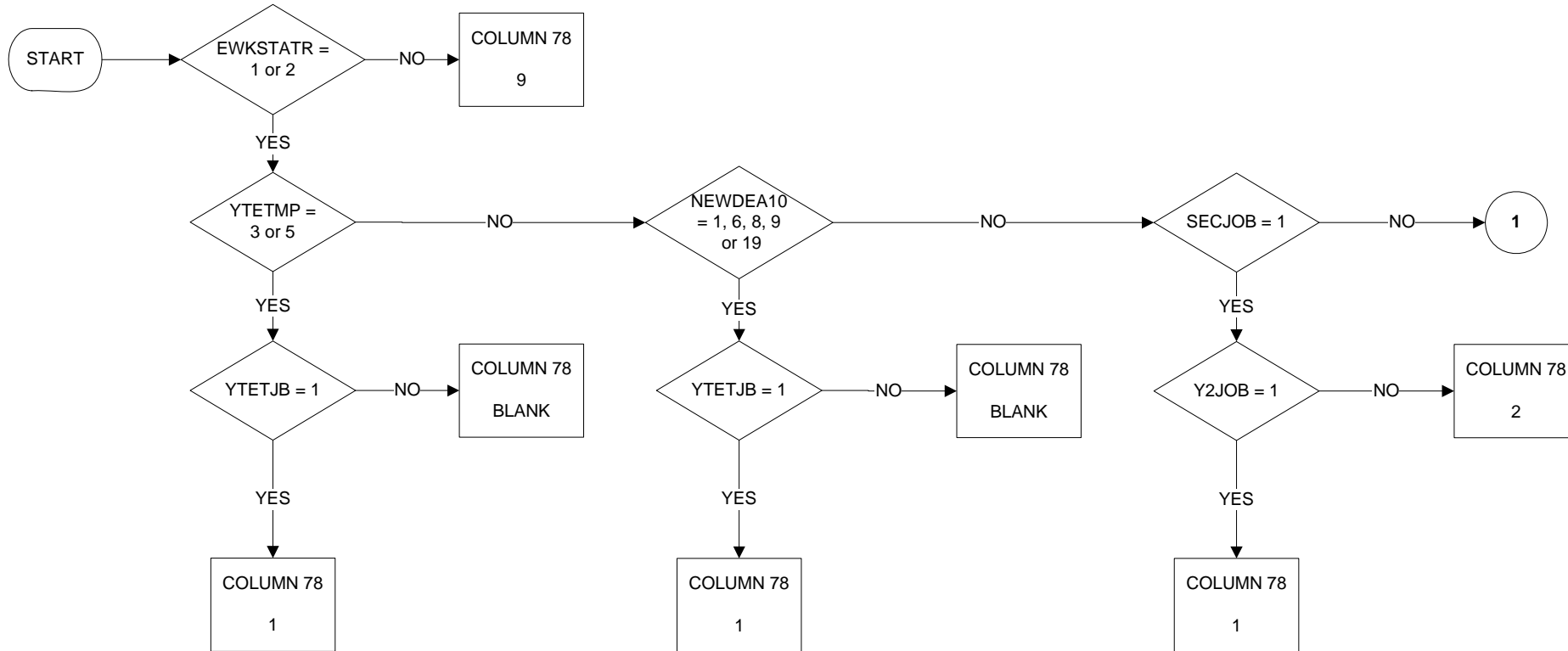

| KEY | |
|-----|---|
| 1 | Person had only one job or business during the reference week |
| 2 | Person had more than one job or business during the reference week (not due to change of job or business) |

STAPRO2J (ESTAT2R): Professional status in second job

Column 79

PAGE 1 OF 1

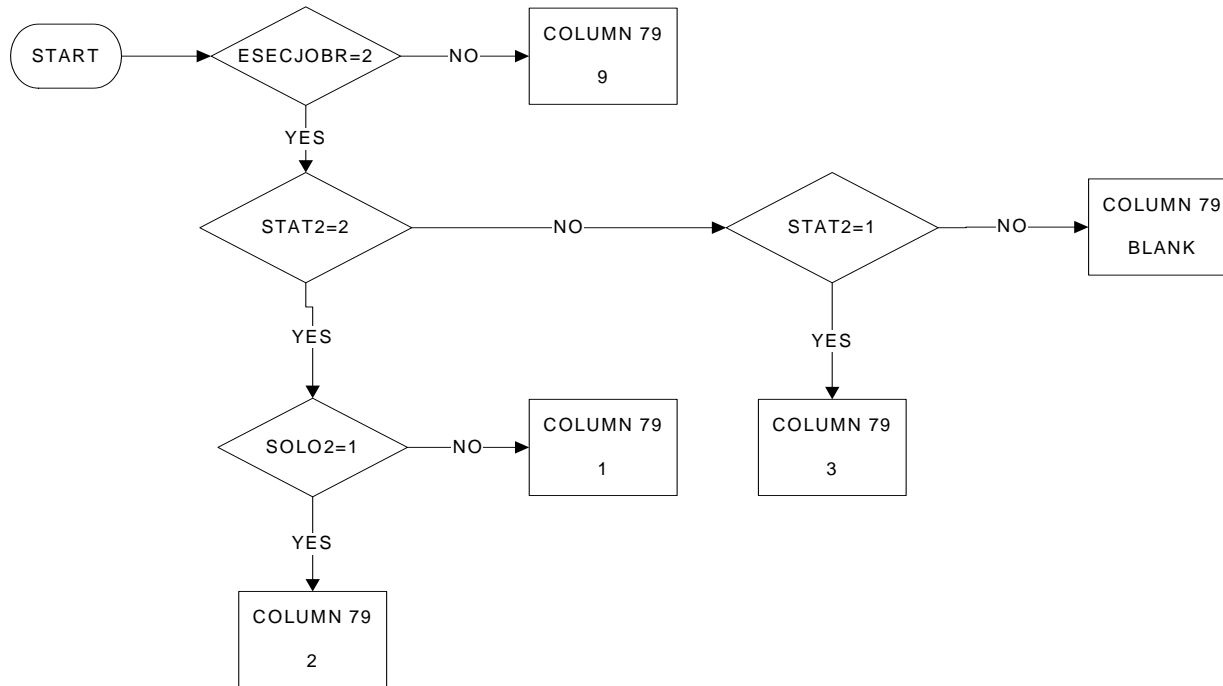

| KEY | |
|-------|--|
| 1 | Self-employed with employees |
| 2 | Self-employed without employees |
| 3 | Employee |
| 4 | Family worker |
| 9 | Not applicable (EXIST2J = 1, 9, BLANK) |
| BLANK | No answer |

NACE2J2D (ENACE208): Economic activity of the local unit (in the second job)

Column 80/81

PAGE 1 OF 1

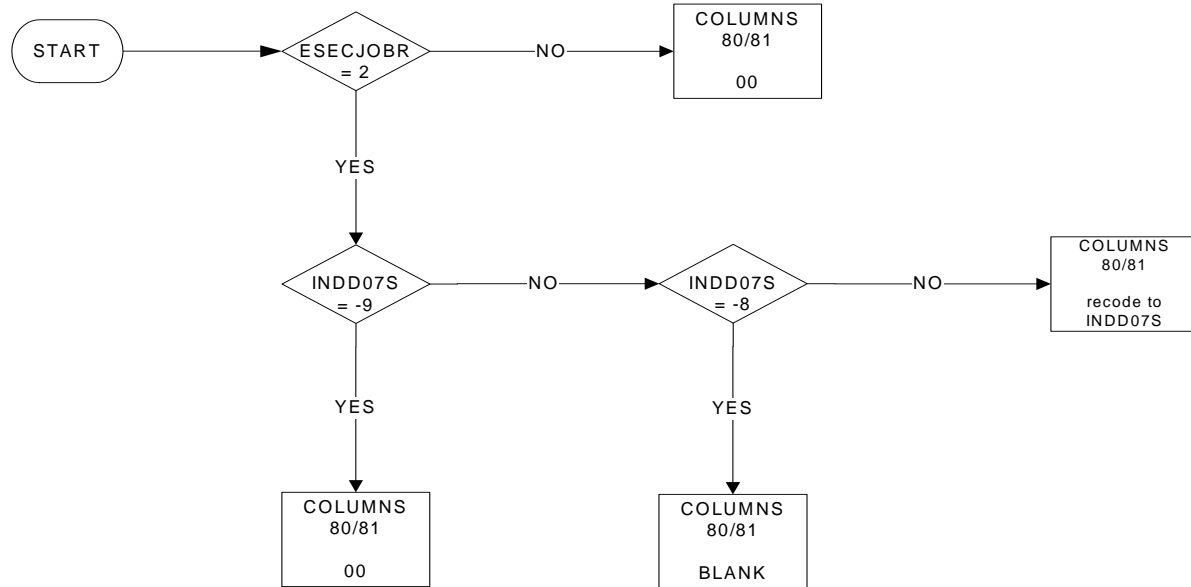

| KEY | |
|-------|--|
| | Nace Rev. 2 |
| 00 | Not applicable (EXIST2J = 1, 9, BLANK) |
| Blank | No answer |

HWACTUA2 (EACTHR2R): Number of hours actually worked in second job
 Columns 82/83
 PAGE 1 OF 1

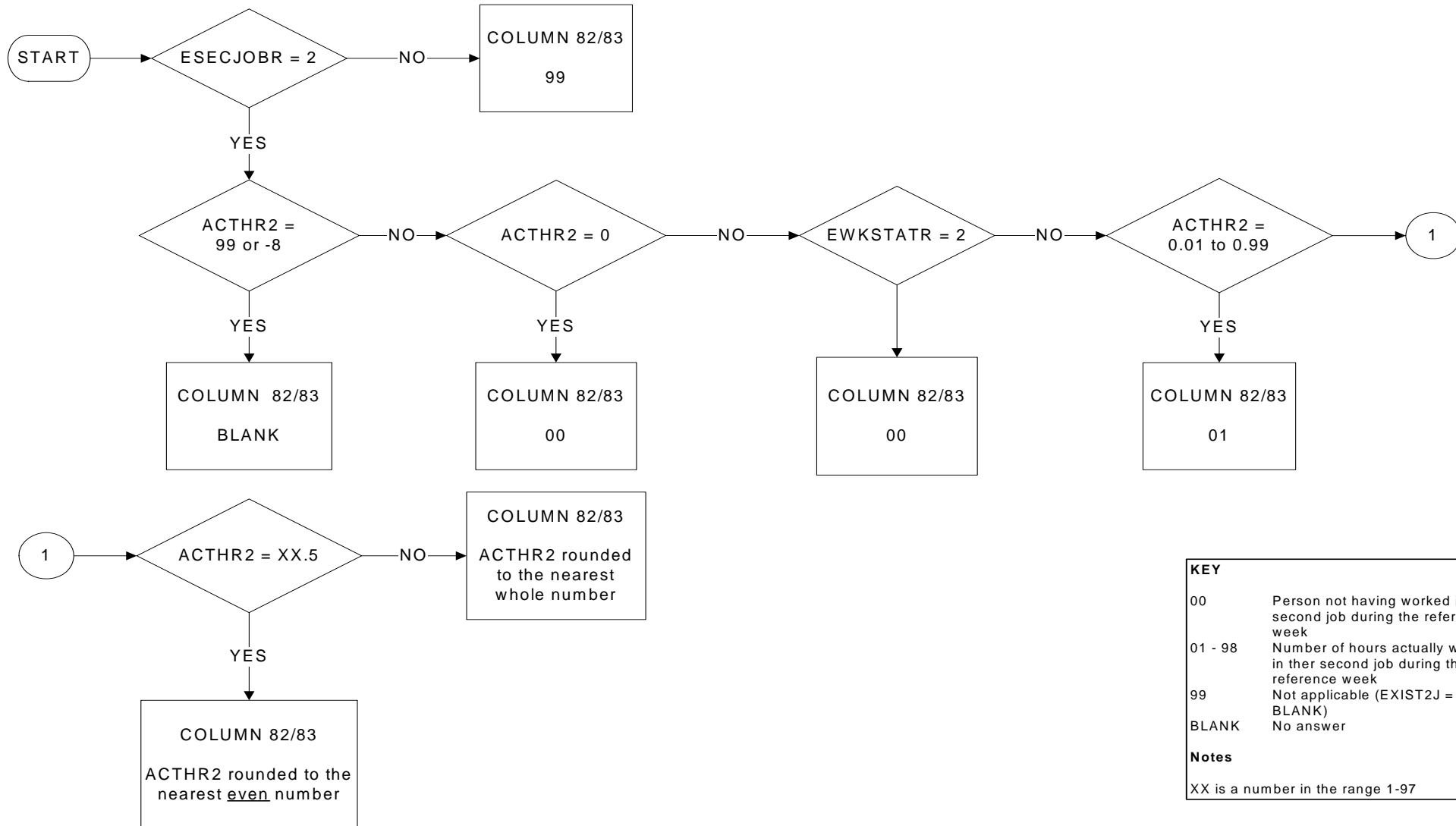

| KEY | |
|----------------------------------|---|
| 00 | Person not having worked in the second job during the reference week |
| 01 - 98 | Number of hours actually worked in their second job during the reference week |
| 99 | Not applicable (EXIST2J = 1, 9, BLANK) |
| BLANK | No answer |
| Notes | |
| XX is a number in the range 1-97 | |

EXISTPR (EEVWKR): Existence of previous employment experience

Column 84
PAGE 1 OF 1

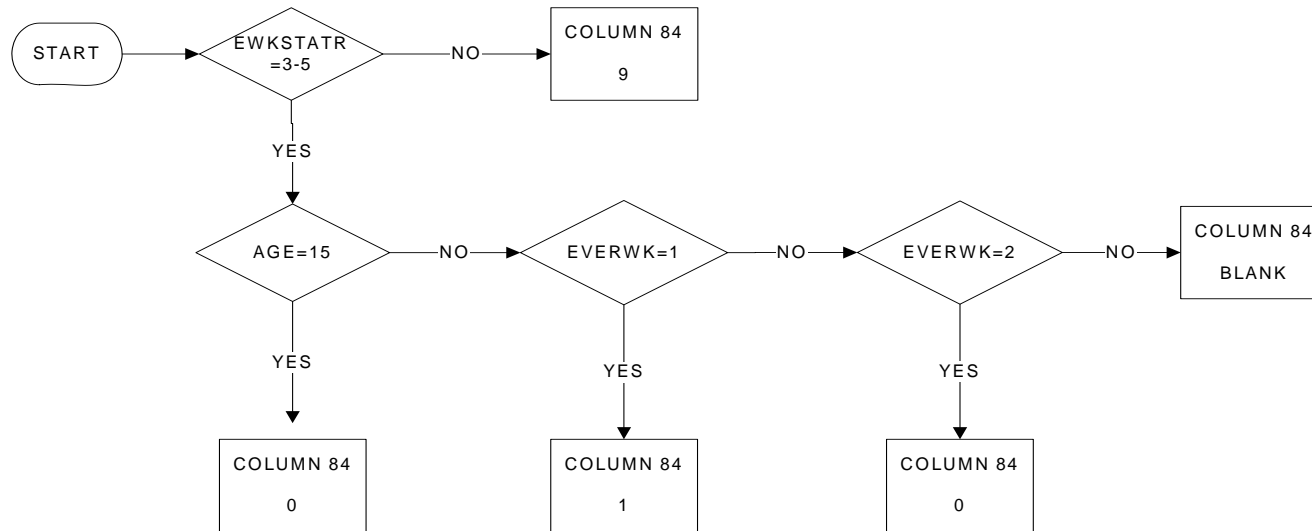

| KEY | |
|-------|--|
| 0 | Person has never been in employment (purely occasional work, such as vacation work, compulsory military or community service are not to be considered as employment) |
| 1 | Person has already been in employment (purely occasional work, such as vacation work, compulsory military or community service are not to be considered as employment) |
| 9 | Not applicable (WSTATOR = 1, 2 or 9) |
| BLANK | No answer |

YEARPR (EYRLASTR): Year in which person last worked

Columns 85/88

PAGE 1 OF 1

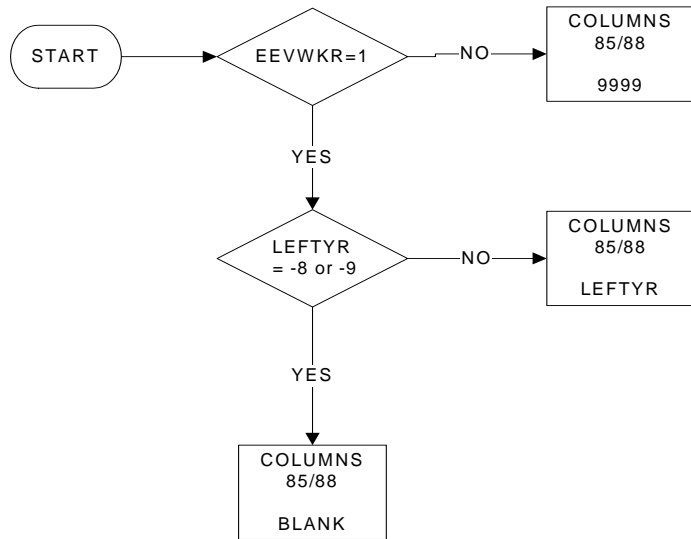

| KEY | |
|-------|--|
| | Enter the 4 digits of the year in which person last worked |
| 9999 | Not applicable (EXISTPR = 0, 9, BLANK) |
| BLANK | No answer |

MONTHPR (EMNLASTR): Month in which person last worked

Columns 89/90

PAGE 1 OF 1

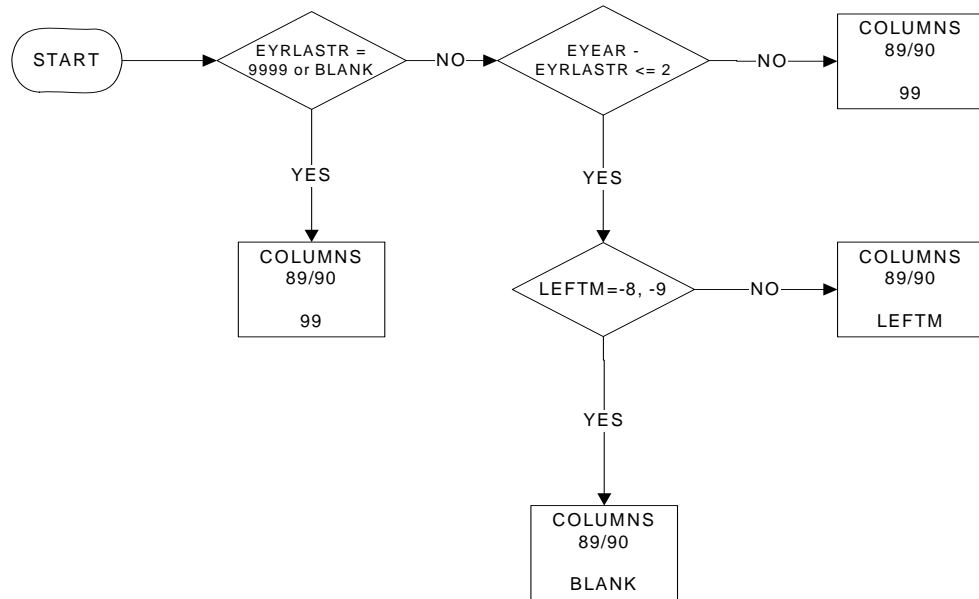

KEY

| | |
|-------|---|
| 01-12 | Enter the number of the month in which person last worked |
| 99 | Not applicable (YEARPR = 9999, BLANK or REFYEAR-YEARPR>2) |
| BLANK | No answer |

LEAVREAS (EWHYLFTR): Main reason for leaving last job or business

Column 91/92

PAGE 1 OF 1

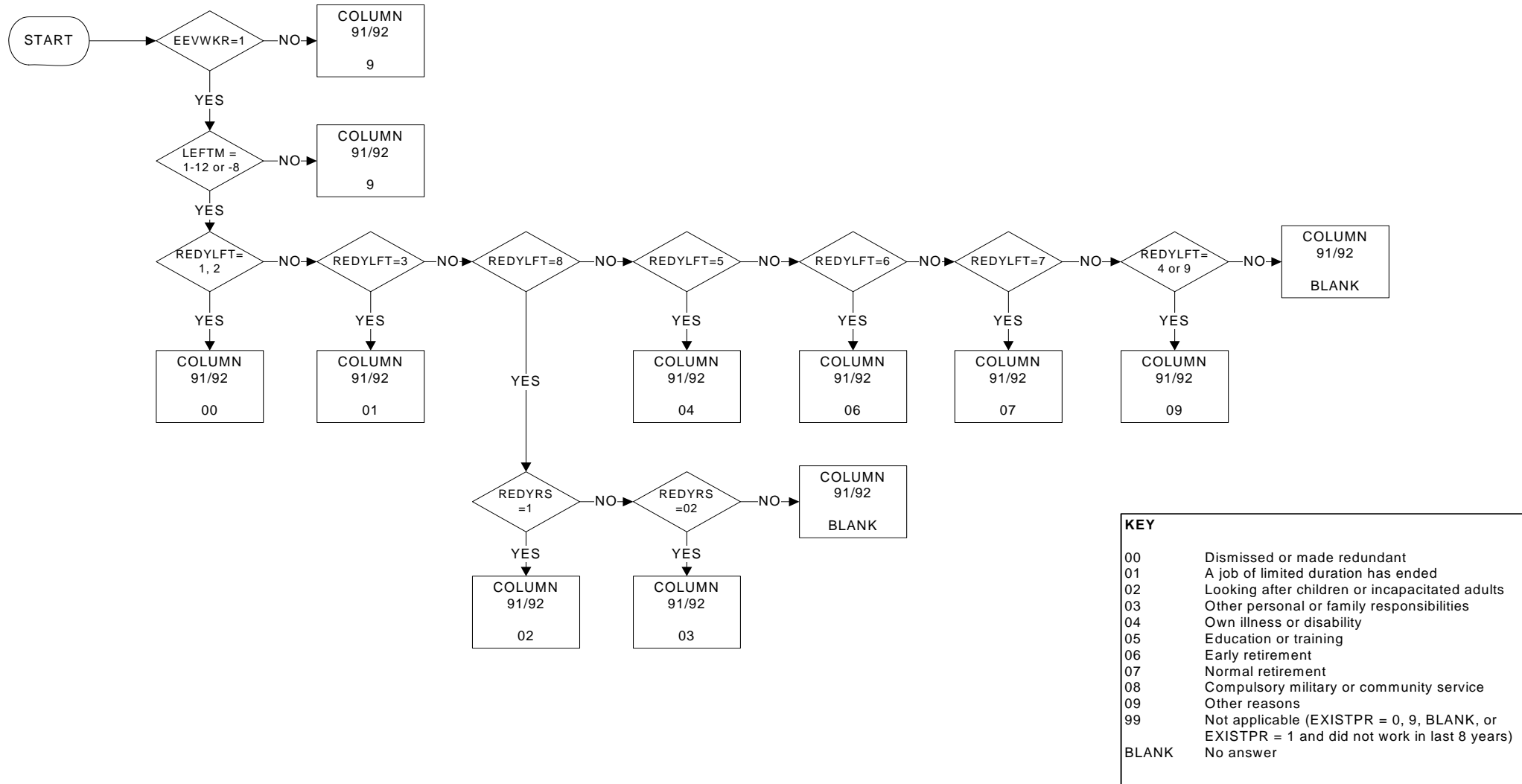

| KEY | |
|-------|---|
| 00 | Dismissed or made redundant |
| 01 | A job of limited duration has ended |
| 02 | Looking after children or incapacitated adults |
| 03 | Other personal or family responsibilities |
| 04 | Own illness or disability |
| 05 | Education or training |
| 06 | Early retirement |
| 07 | Normal retirement |
| 08 | Compulsory military or community service |
| 09 | Other reasons |
| 99 | Not applicable (EXISTPR = 0, 9, BLANK, or EXISTPR = 1 and did not work in last 8 years) |
| BLANK | No answer |

STAPROPR (ESTATLR): Professional status in last job

Column 93
PAGE 1 OF 1

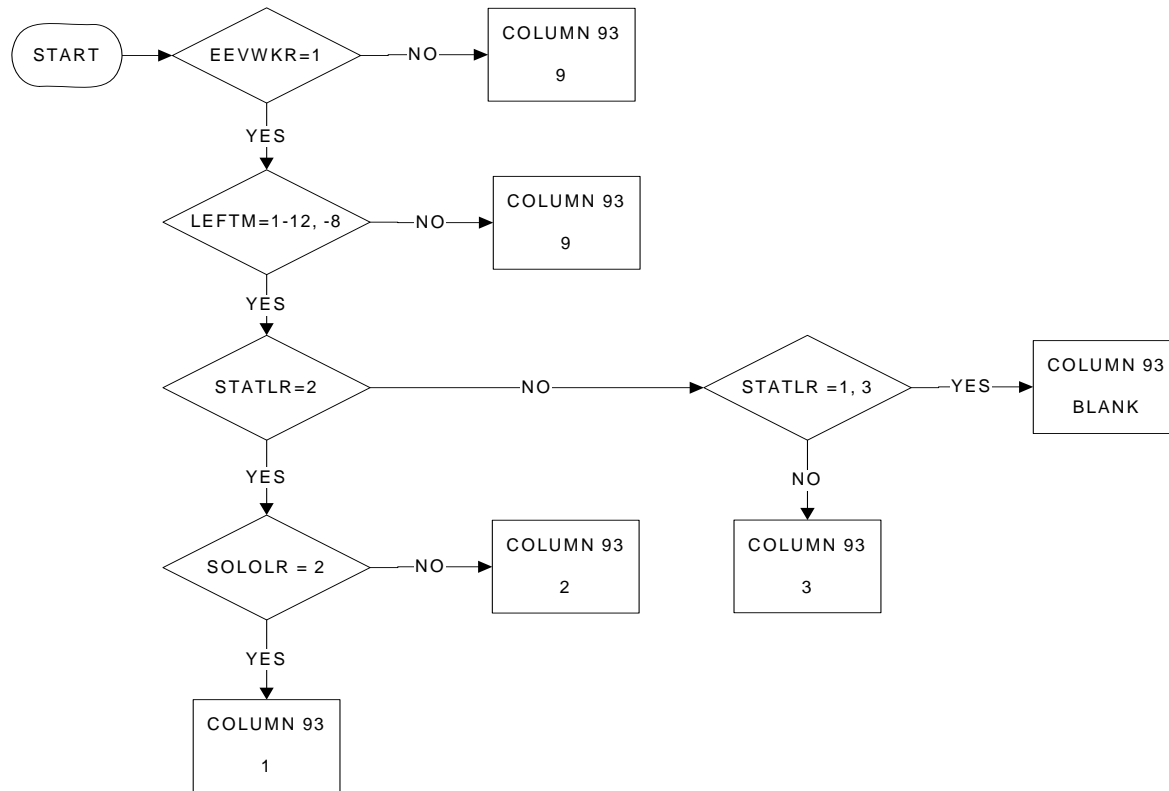

| KEY | |
|-------|---|
| 1 | Self-employed with employees |
| 2 | Self-employed without employees |
| 3 | Employee |
| 4 | Family worker |
| 9 | Not applicable (EXISTPR = 0, 9, BLANK, or EXISTPR = 1 and did not work in last 8 years) |
| BLANK | No answer |

NACEPR2D (ENACEL08): Economic activity of the local unit in which person last worked

Column 94/95

PAGE 1 OF 1

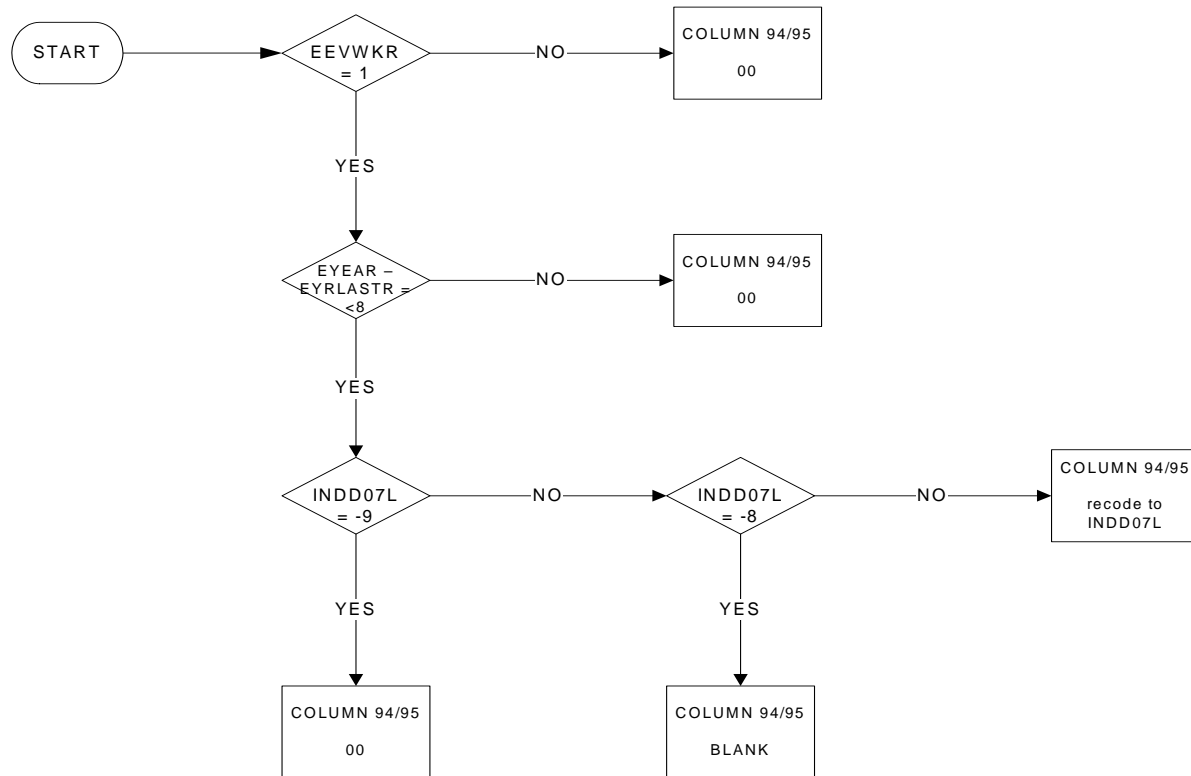

| KEY | |
|-------|--|
| | NACE Rev. 2 |
| 00 | Not applicable (col 84 = 0, 9, BLANK or col 84 = 1 and did not work in last eight years) |
| Blank | No answer |

ISCOPR3D (EISCOLR): Occupation of last job

Columns 96/98

PAGE 1 OF 1

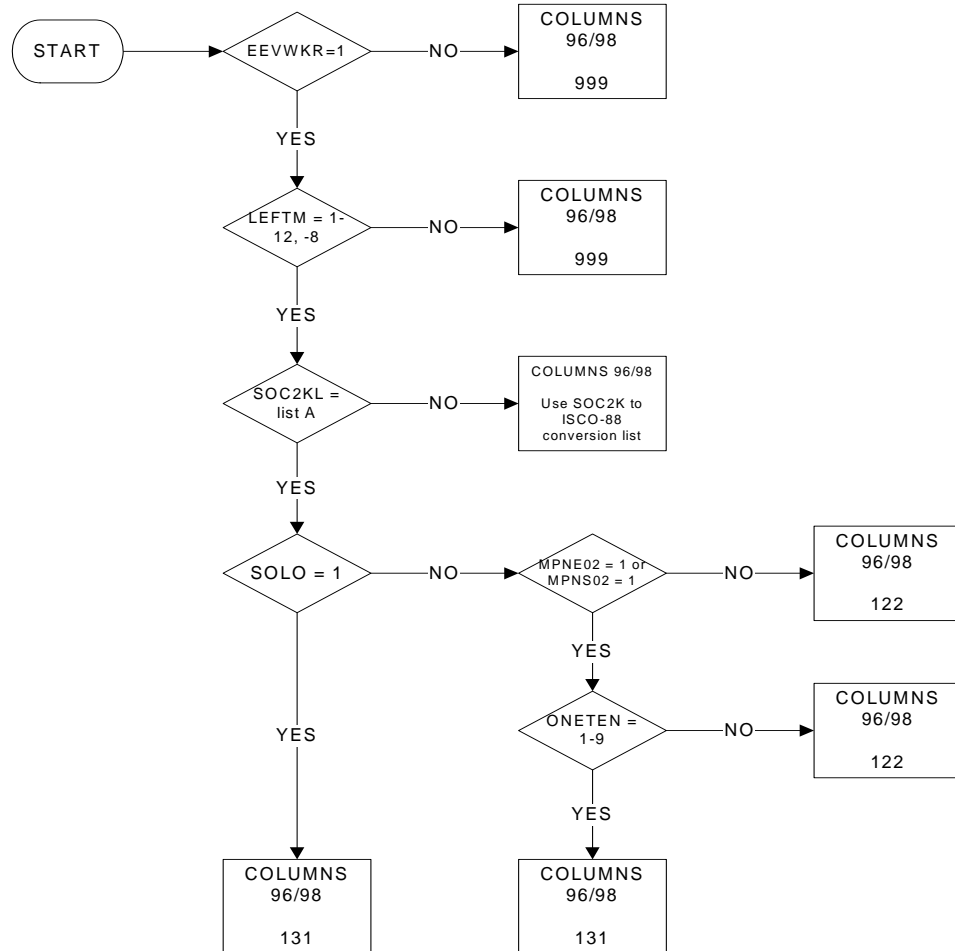

KEY

999 Not applicable (EXISTPR = 0, 9, BLANK or EXISTPR = 1 and did not work in last 8 years)

BLANK No answer

Notes

List A=
 1121, 1122, 1151, 1222, 1231, 1161, 1162, 1226, 1163, 1232, 1182, 1183, 1225, 1235, 1239, 1185, 1233, 1211, 1212, 1219, 1221, 1223, 1224

SEEKWORK (ELOOKR): Seeking employment during previous four weeks

Column 99
PAGE 1 OF 1

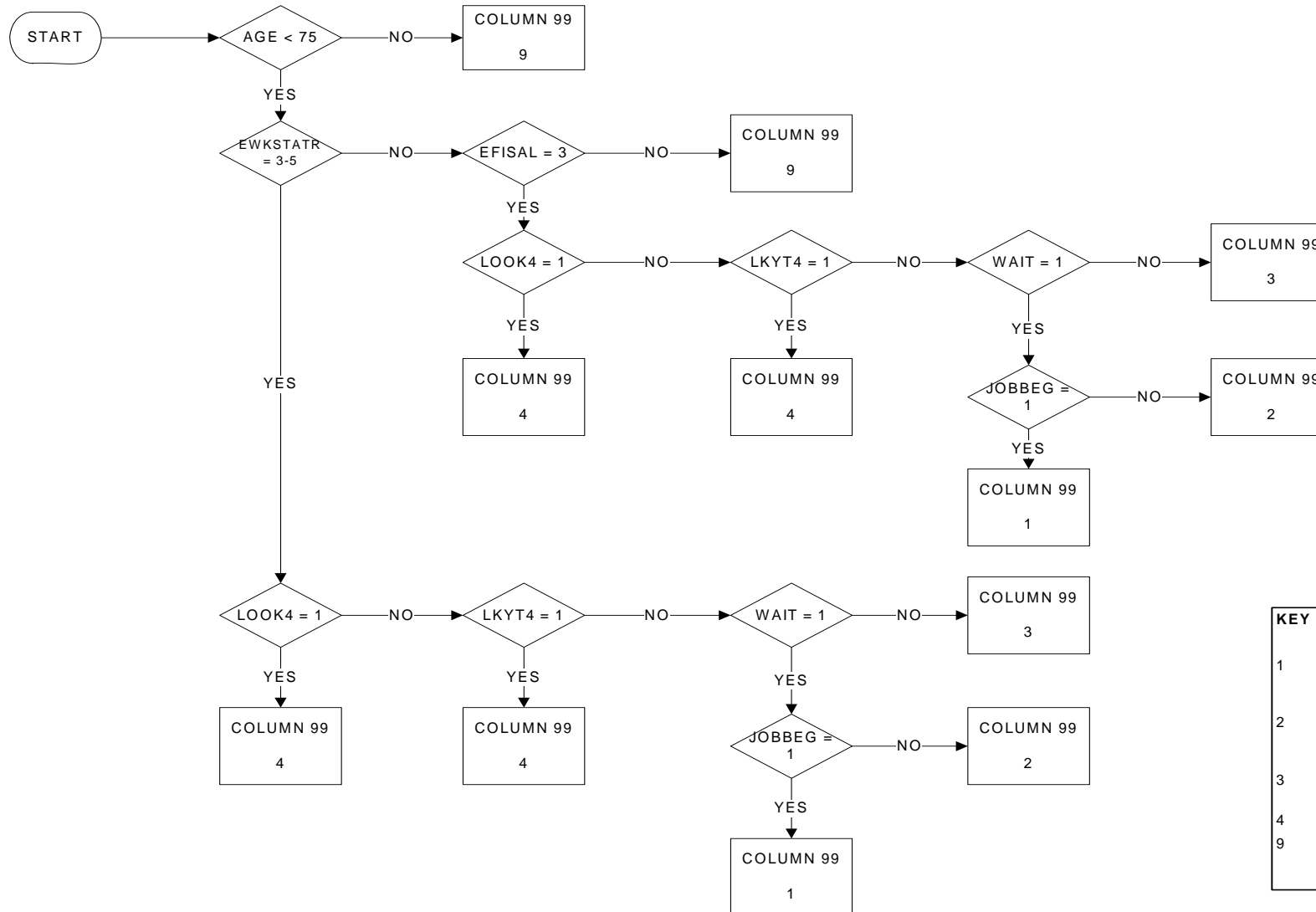

| KEY | |
|-----|---|
| 1 | Person has already found a job which will start within a period of at most 3 months |
| 2 | Person has already found a job which will start in more than 3 months and is not seeking employment |
| 3 | Person is not seeking employment and has not found any job to start later |
| 4 | Person is seeking employment |
| 9 | Not applicable (WSTATOR = 1, 2 or 9 and SIGNISAL ? 3) or Age = 75 |

SEEKWORK (ENOLWM): Reasons for not seeking employment

Column 100
PAGE 1 OF 1

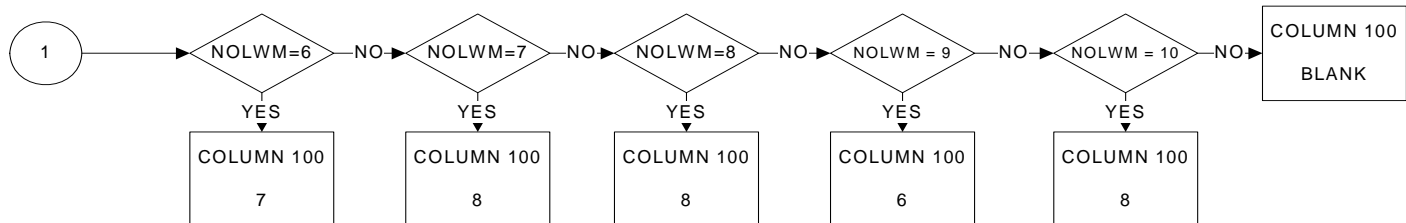
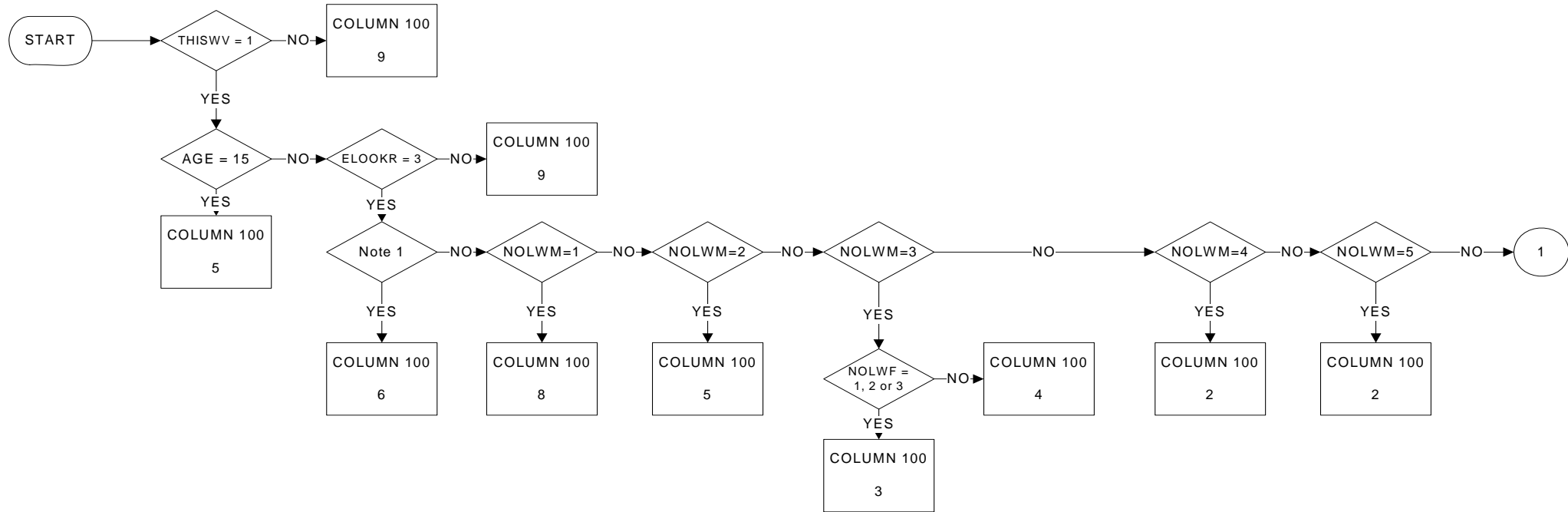

| KEY | |
|-------|--|
| 1 | Awaiting recall to work (person on lay-off) |
| 2 | Because of own illness or disability |
| 3 | looking after children or incapacitated adults |
| 4 | Because of other personal or family responsibilities |
| 5 | Because of education or training |
| 6 | Because of retirement |
| 7 | Because of belief that no work is available |
| 8 | Because of other reasons |
| 9 | Not applicable (SEEKWORK ? 3) |
| BLANK | No answer |

Note 1:
(SEX=1 & AGE>=70) or (SEX=2 & AGE>=65)

SEEKTYPE (ETYMP SR): Type of employment sought (or found)

Column 101

PAGE 1 OF 2

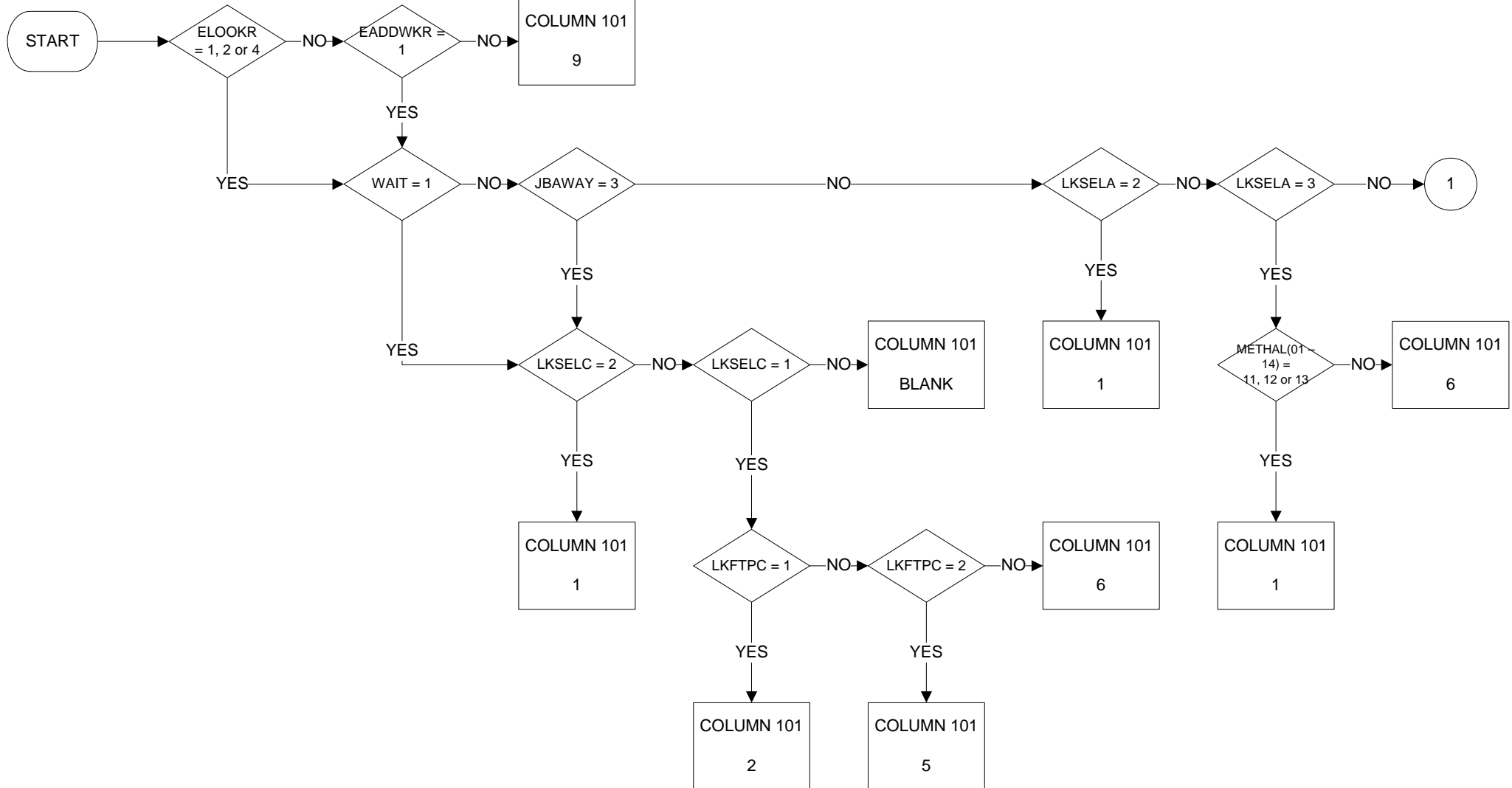

SEEKTYPE (ETYMP SR): Type of employment sought (or found)

Column 101

PAGE 2 OF 2

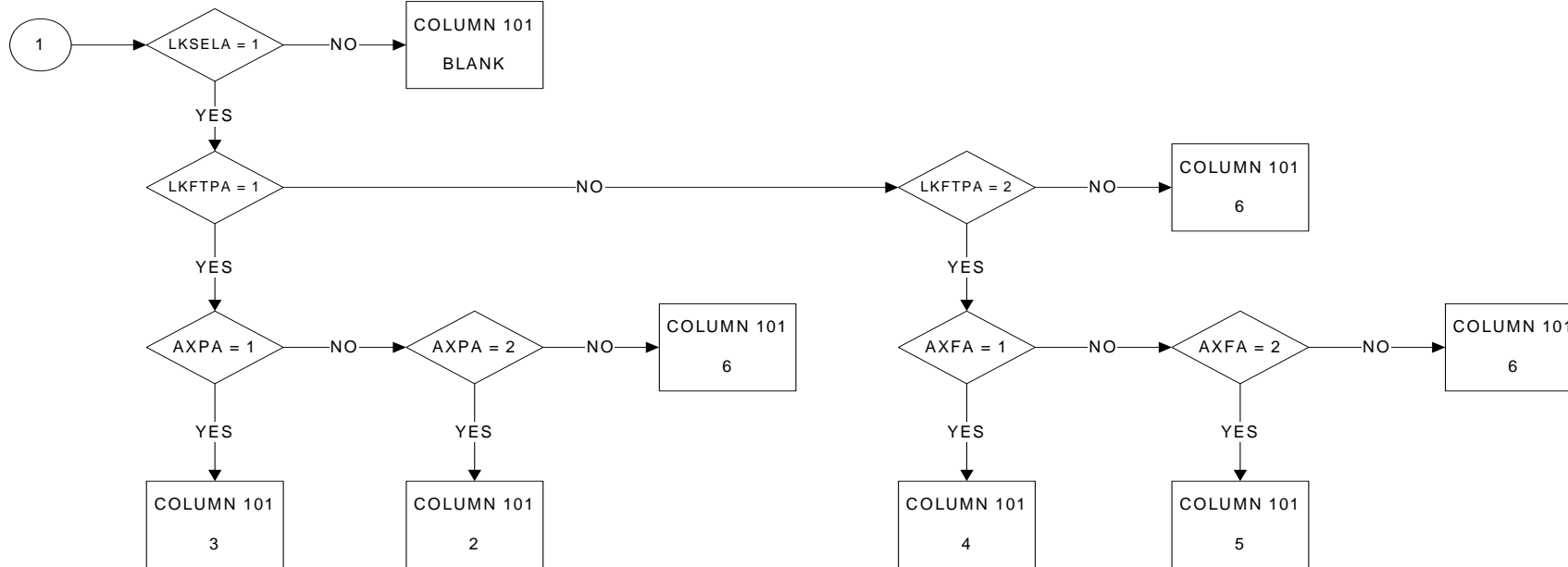

| KEY | |
|-------|---|
| 1 | As self-employed |
| | As Employee: |
| 2 | Only full time is looked for (or has already been found) |
| 3 | Full time job is sought, but if not available, part time job will be accepted |
| 4 | Part time job is sought, but if not available, full time job will be accepted |
| 5 | Only part time job is looked for (or has already been found) |
| 6 | Person did not state whether full time or part time job is looked for (or has already been found) |
| 9 | Not applicable (SEEKWORK ? 1, 2, 4 and LOOKOJ ? 1) |
| BLANK | No Answer |

SEEKDUR (ELKTIMR): Duration of search for employment

Column 102
PAGE 1 OF 2

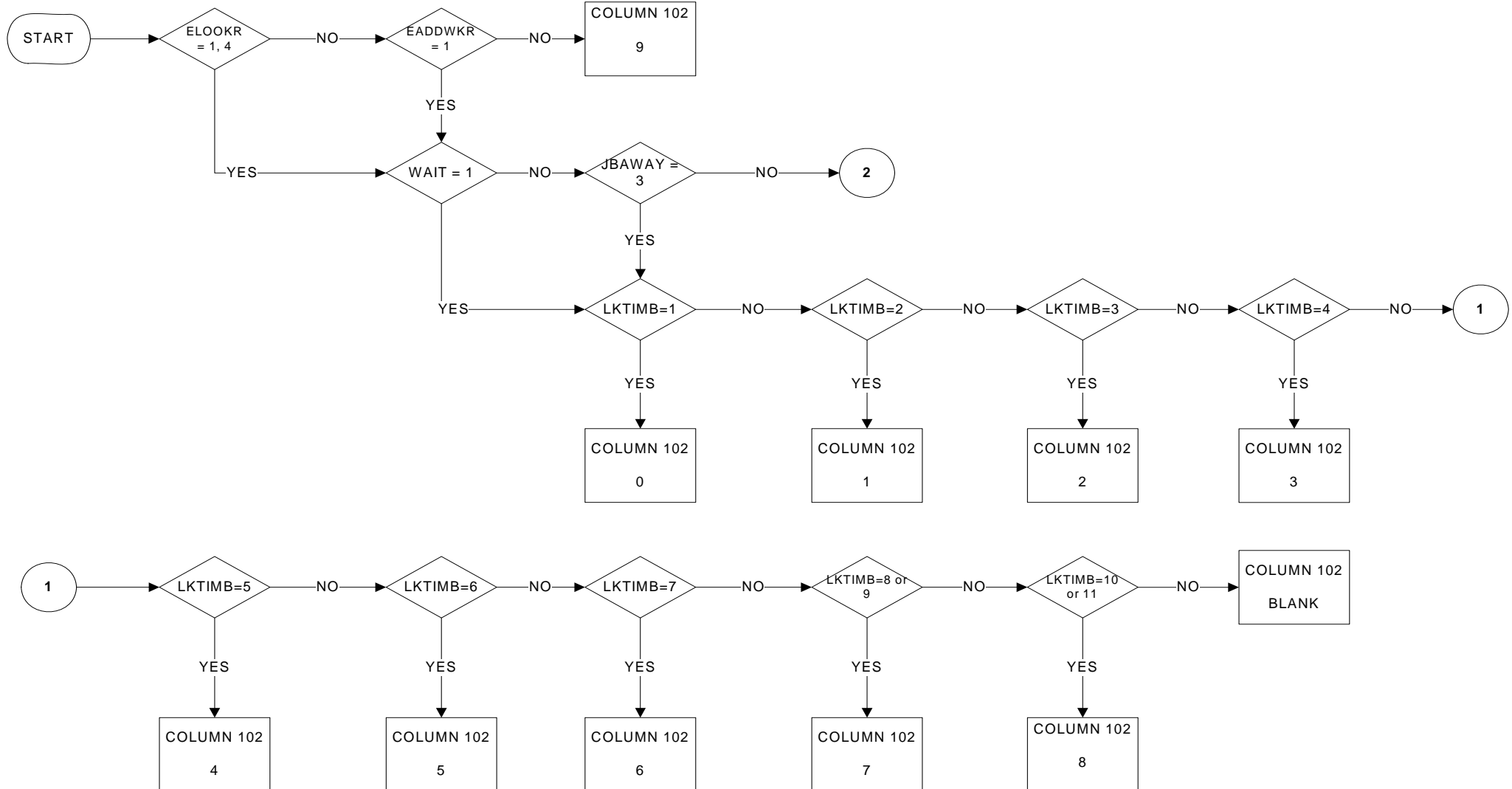

SEEKDUR (ELKTIMR): Duration of search for employment

Column 102

PAGE 2 OF 2

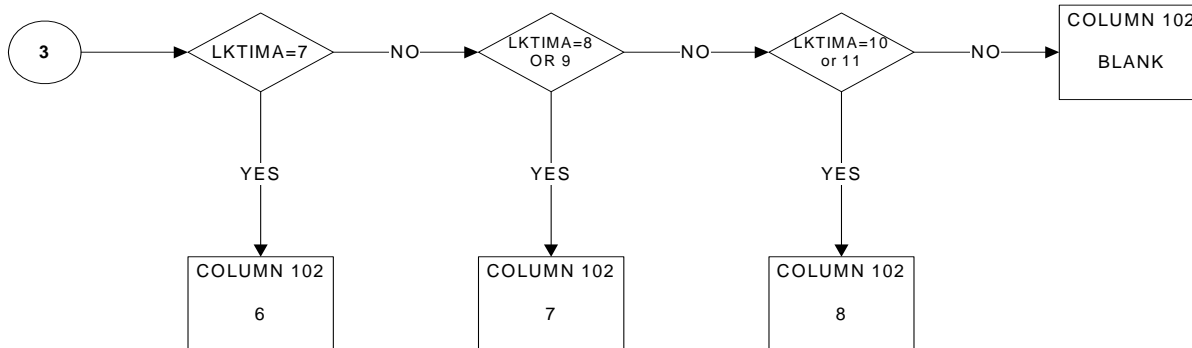
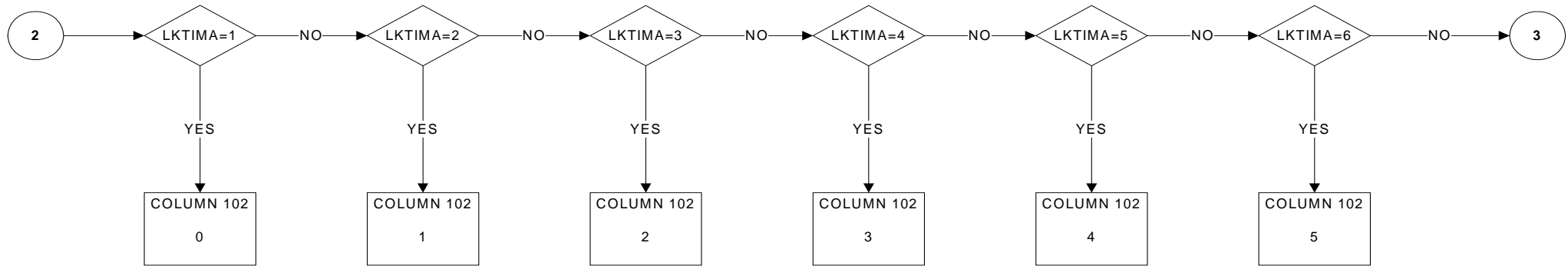

| KEY | |
|-------|---|
| 0 | Search not yet started |
| 1 | Less than 1 month |
| 2 | 1-2 months |
| 3 | 3-5 months |
| 4 | 6-11 months |
| 5 | 12-17 months |
| 6 | 18-23 months |
| 7 | 24-47 months |
| 8 | 4 years or longer |
| 9 | Not applicable (SEEKWORK ? 1, 4 and LOOKOJ ? 1) |
| BLANK | No answer |

METHODA (EMETH1R): Contacted public employment office to find work

Column 103

PAGE 1 OF 1

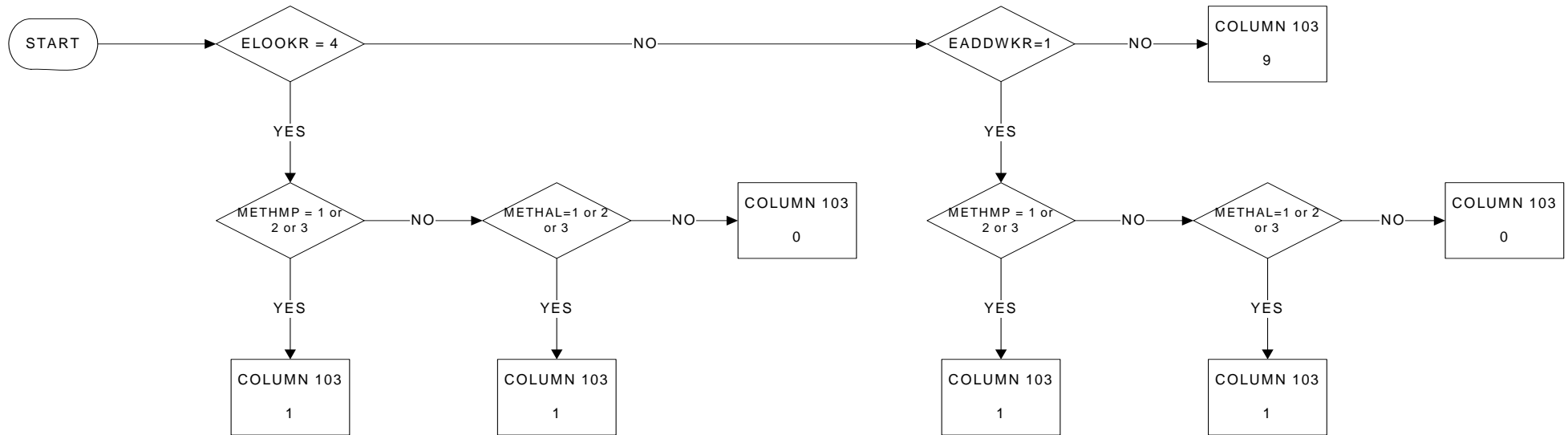

| KEY | |
|-----|--|
| 0 | No |
| 1 | Yes |
| 9 | Not applicable (SEEKWORK ? 4 and LOOKOJ ? 1) |

METHODB (EMETH2R): Contacted private employment agency to find work

Column 104

PAGE 1 OF 1

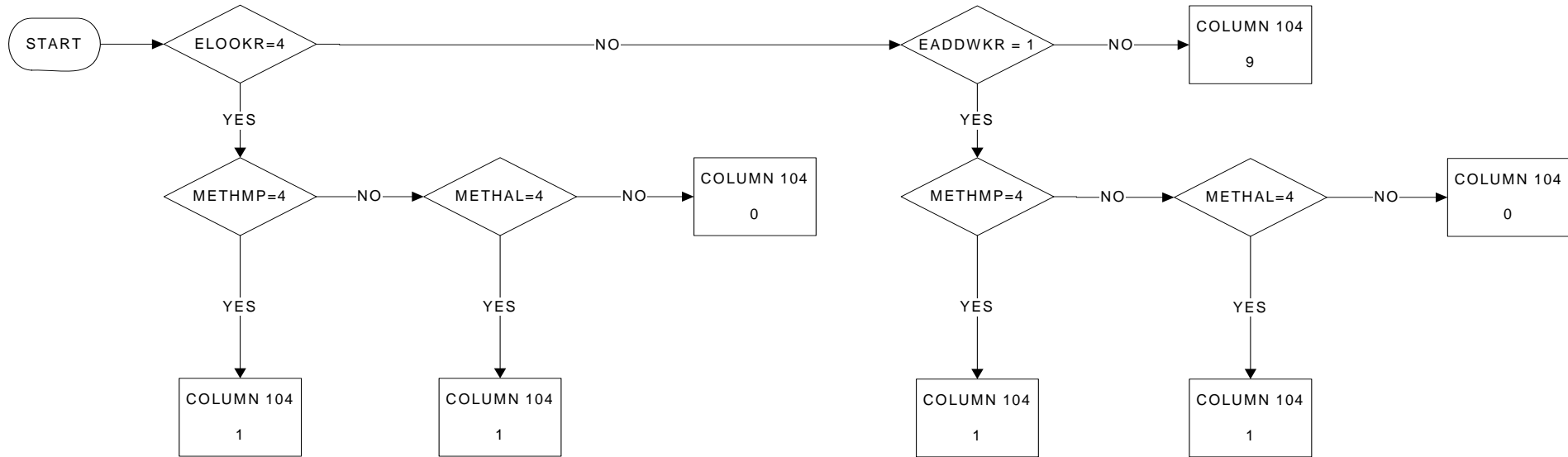

| KEY | |
|-----|--|
| 0 | No |
| 1 | Yes |
| 9 | Not applicable (SEEKWORK ? 4 and LOOKOJ ? 1) |

METHODC (EMETH3R): Applied to employers directly

Column 105
PAGE 1 OF 1

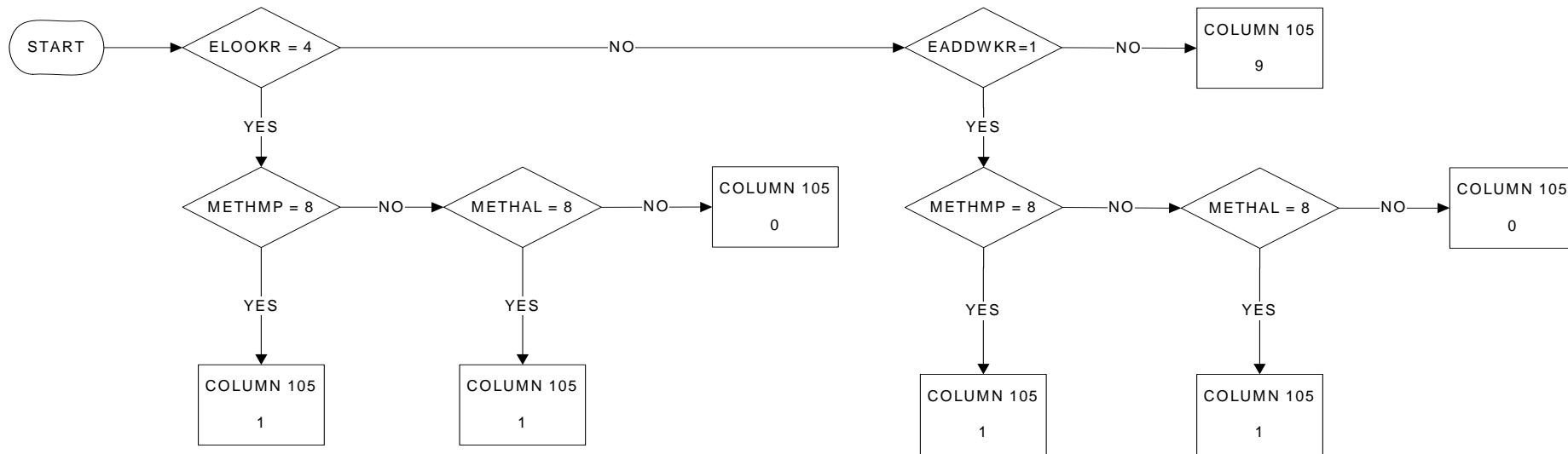

| KEY | |
|-----|--|
| 0 | No |
| 1 | Yes |
| 9 | Not applicable (SEEKWORK ? 4 and LOOKOJ ? 1) |

METHODD (EMETH4R): Asked friends, relatives, trade unions etc

Column 106

PAGE 1 OF 1

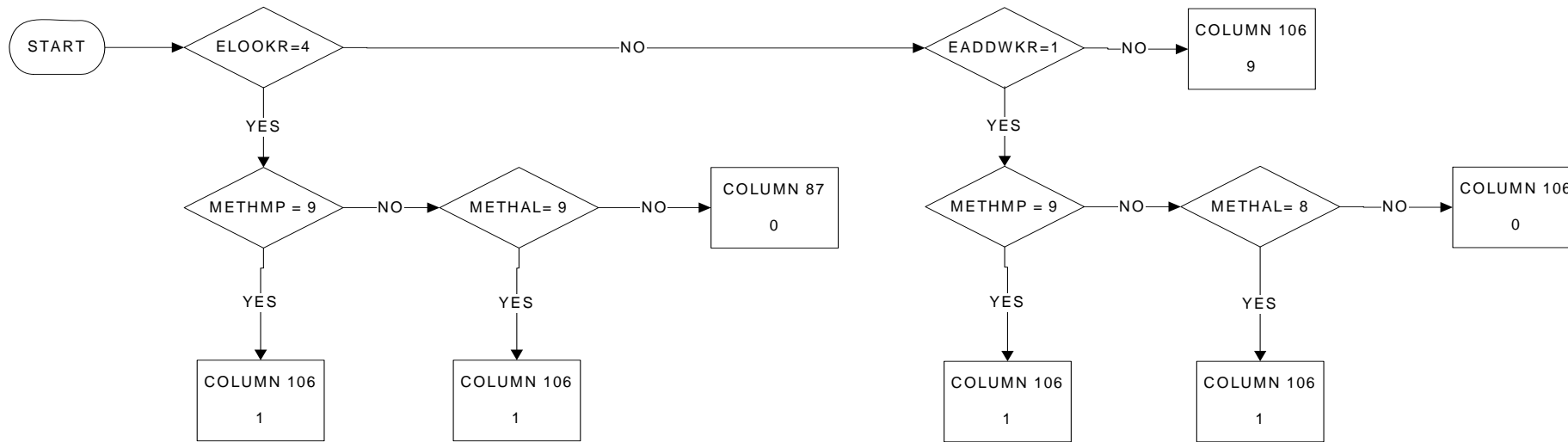

| KEY | |
|-----|--|
| 0 | No |
| 1 | Yes |
| 9 | Not applicable (SEEKWORK ? 4 and LOOKOJ ? 1) |

METHODE (EMETH5R): Inserted or answered adverts in newspapers or journals

Column 107
PAGE 1 OF 1

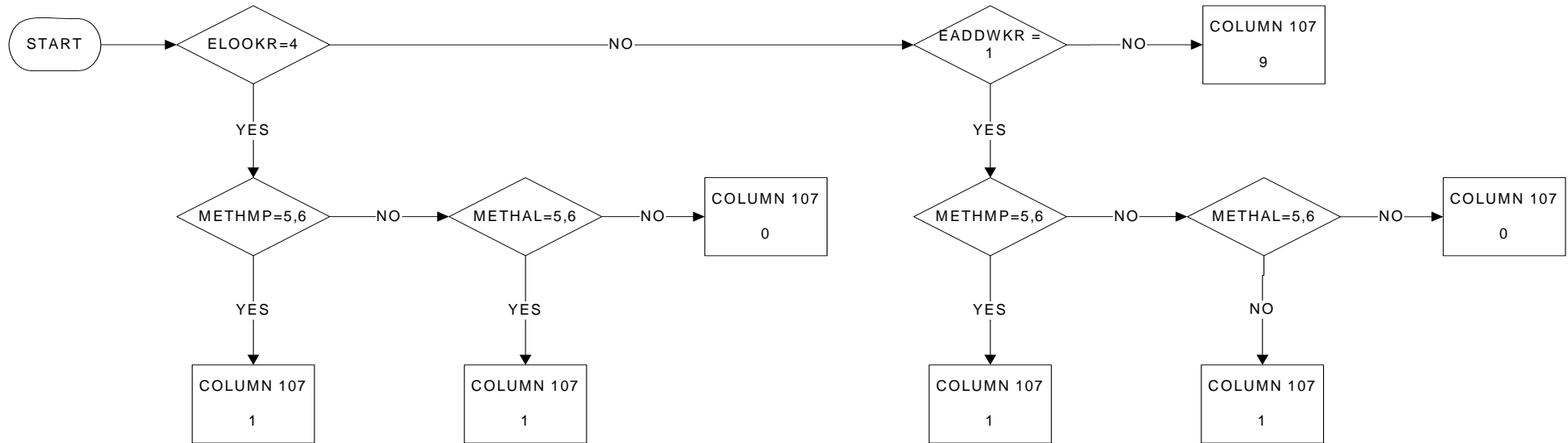

| KEY | |
|-----|--|
| 0 | No |
| 1 | Yes |
| 9 | Not applicable (SEEKWORK ? 4 and LOOKOJ ? 1) |

METHODF (EMETH6R): Studied adverts in newspapers or journals

Column 108

PAGE 1 OF 1

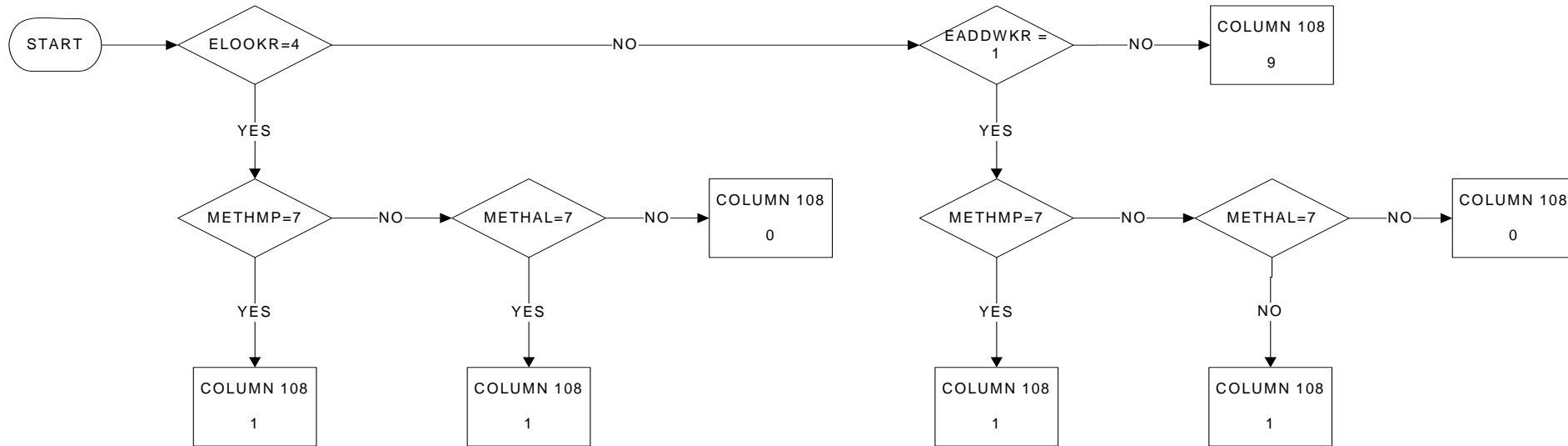

| KEY | |
|-----|--|
| 0 | No |
| 1 | Yes |
| 9 | Not applicable (SEEKWORK ? 4 and LOOKOJ ? 1) |

METHODG (EMETH7R): Took a test, interview or examination

Column 109

PAGE 1 OF 1

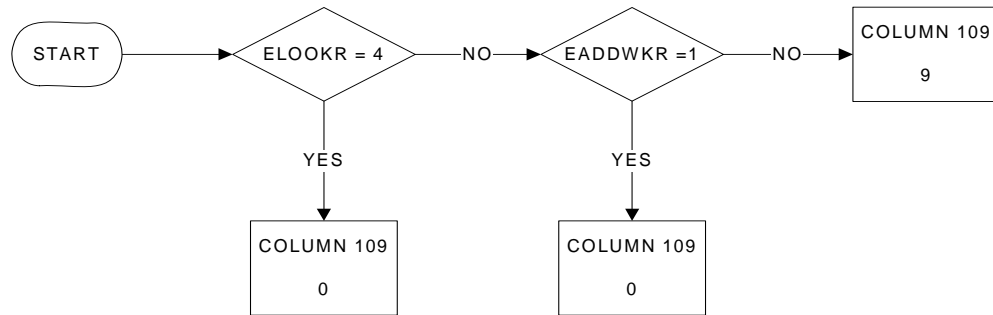

KEY

| | |
|---|--|
| 0 | No |
| 1 | Yes |
| 9 | Not applicable (SEEKWORK ? 4 and LOOKOJ ? 1) |

Notes

An answer of No (0) is given for all respondents as taking a test, interview or examination as a method of FINDING work is not used in the UK.

METHODH (EMETH8R): Looked for land, premises or equipment

Column 110

PAGE 1 OF 1

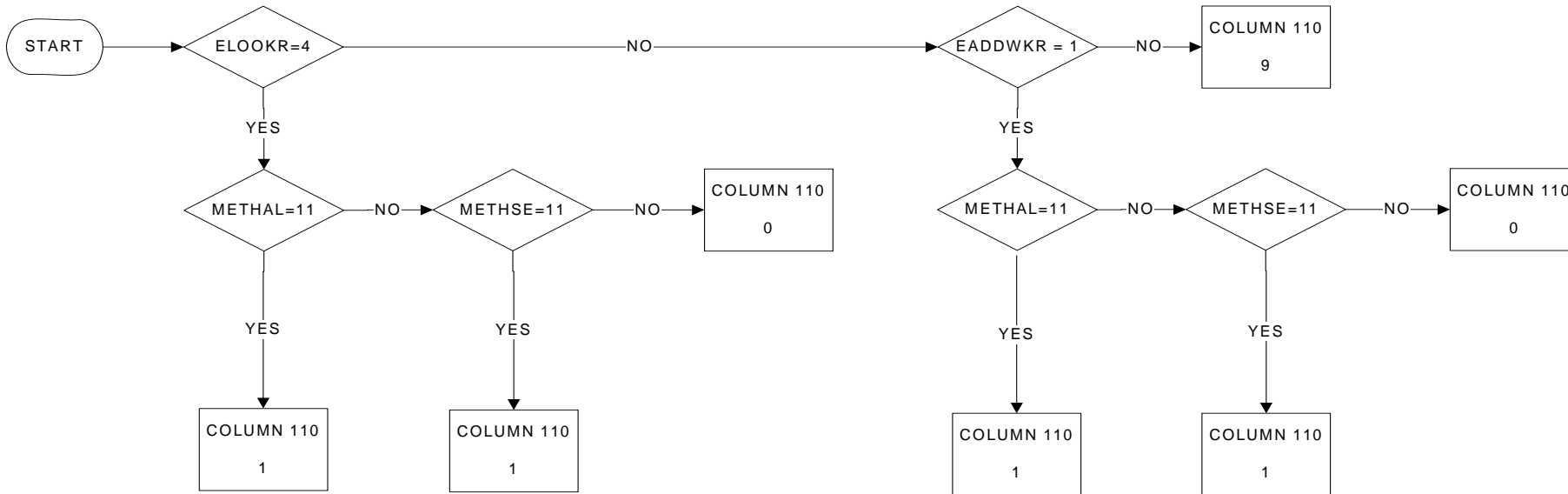

| KEY | |
|-----|--|
| 0 | No |
| 1 | Yes |
| 9 | Not applicable (SEEKWORK ? 4 and LOOKOJ ? 1) |

METHOD1 (EMETH9R): Looked for permits, licenses or financial resources

Column 111
PAGE 1 OF 1

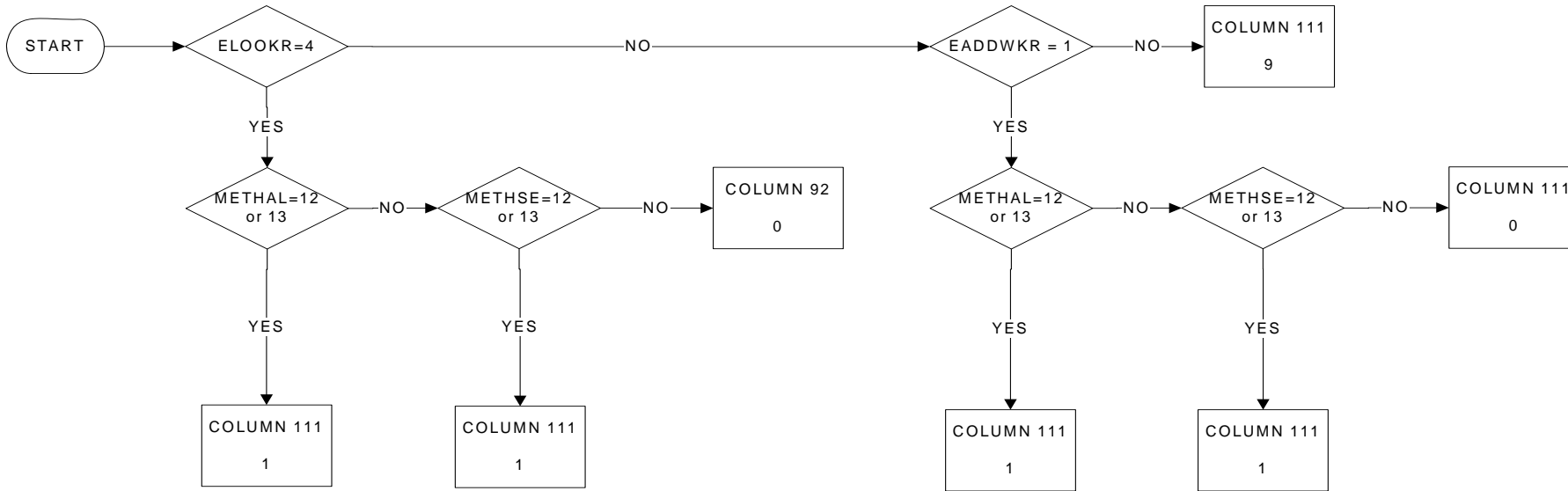

| KEY | |
|-----|--|
| 0 | No |
| 1 | Yes |
| 9 | Not applicable (SEEKWORK ? 4 and LOOKOJ ? 1) |

METHODJ (EMETH10R): Awaiting results of job application

Column 112
PAGE 1 OF 1

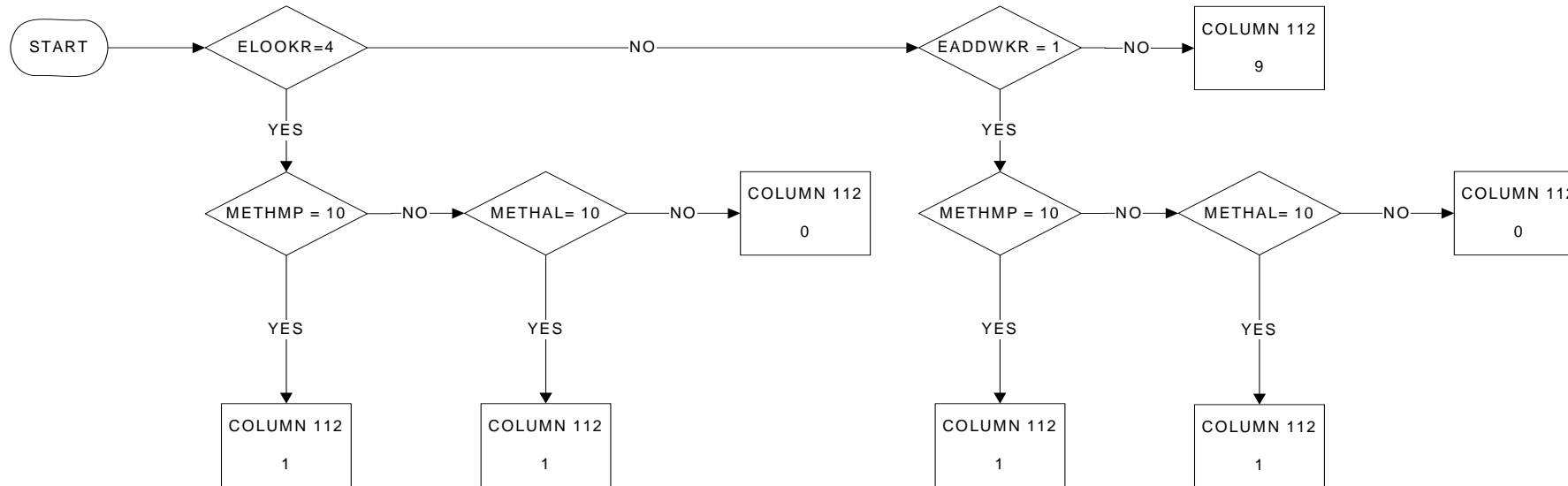

| KEY | |
|-----|--|
| 0 | No |
| 1 | Yes |
| 9 | Not applicable (SEEKWORK ? 4 and LOOKOJ ? 1) |

METHODK (EMETH11R): Waiting for a call from a public employment office

Column 113

PAGE 1 OF 1

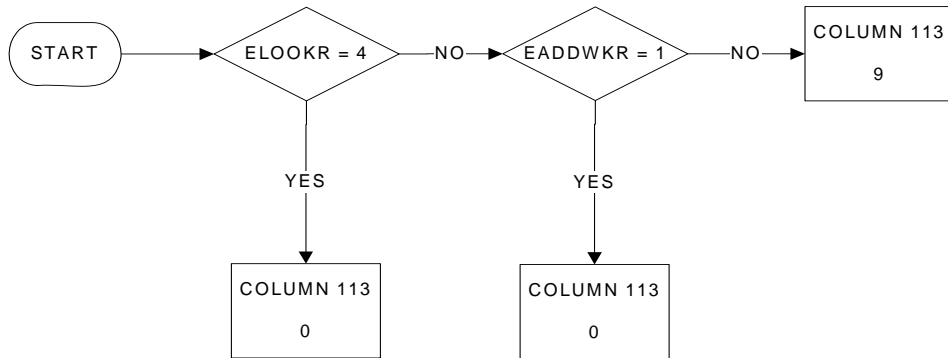

KEY

| | |
|---|--|
| 0 | No |
| 1 | Yes |
| 9 | Not applicable (SEEKWORK ? 4 and LOOKOJ ? 1) |

Notes

An answer of No (0) is given for all respondents as taking a test, interview or examination as a method of FINDING work is not used in the UK.

METHODL (EMETH12R): Awaiting results of a competition for recruitment to public sector

Column 114

PAGE 1 OF 1

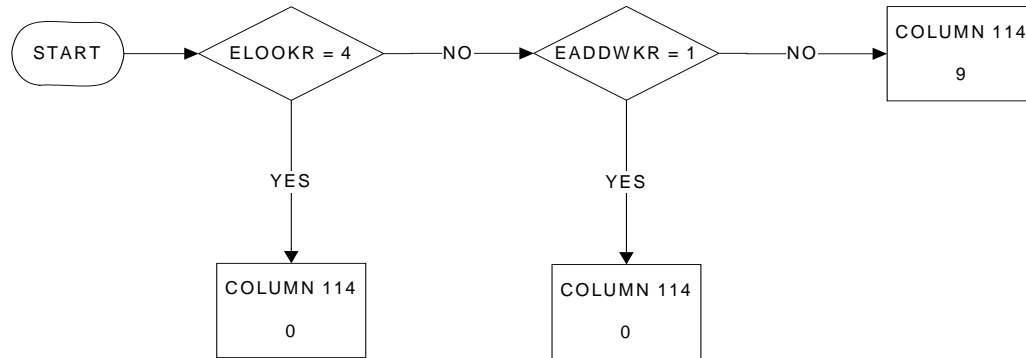

KEY

| | |
|---|--|
| 0 | No |
| 1 | Yes |
| 9 | Not applicable (SEEKWORK ? 4 and LOOKOJ ? 1) |

Notes

An answer of No (0) is given for all respondents as taking a test, interview or examination as a method of FINDING work is not used in the UK.

METHODM (EMETH13R): Other job search method used

Column 115

PAGE 1 OF 1

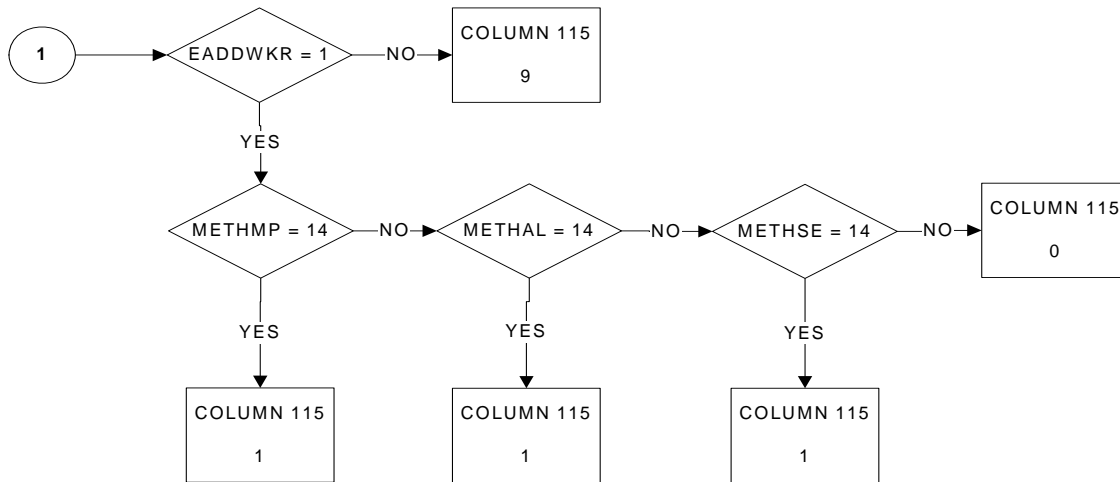
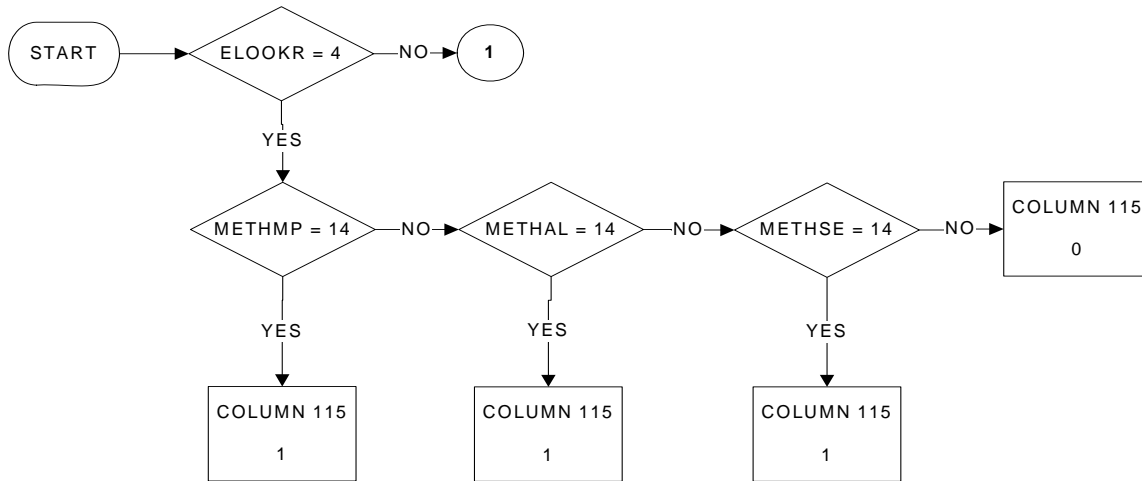

| KEY | |
|-----|--|
| 0 | No |
| 1 | Yes |
| 9 | Not applicable (SEEKWORK ? 4 and LOOKOJ ? 1) |

WANTWORK (ELIKWKR): Willingness to work for person not seeking employment

Column 116

PAGE 1 OF 1

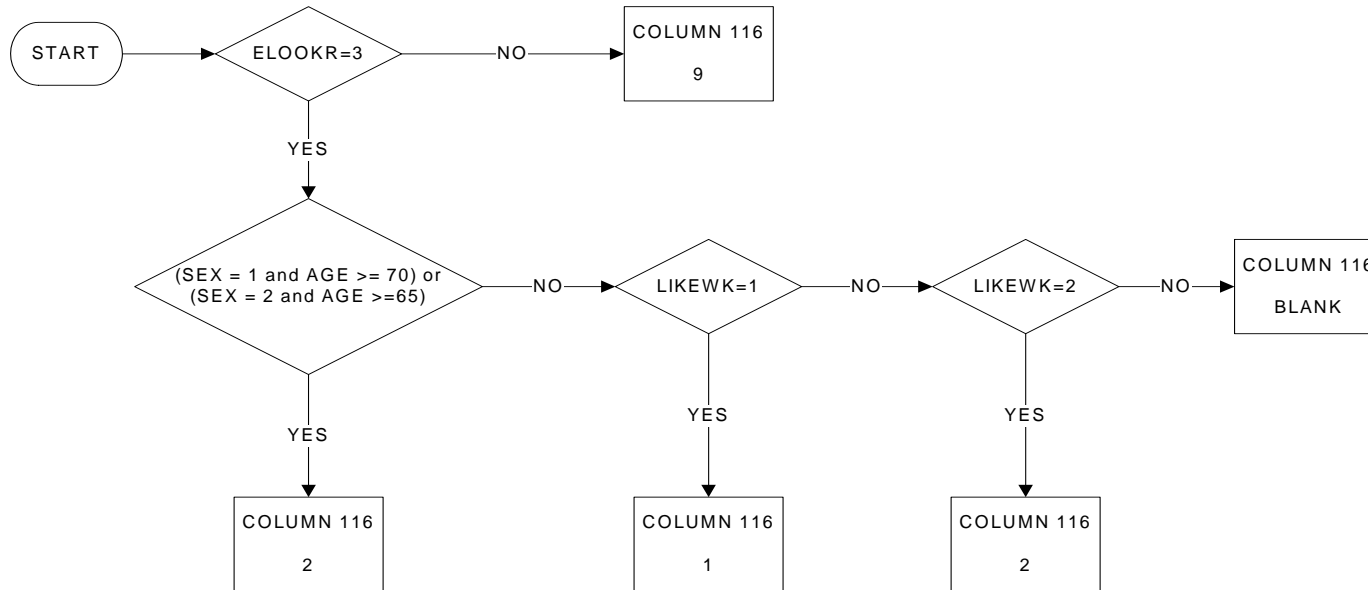

| KEY | |
|-------|--|
| 1 | But would nevertheless like to have work |
| 2 | And does not want to have work |
| 9 | Not applicable (SEEKWORK = 3) |
| BLANK | No answer |

AVAILABLE (EAVALKR): Availability to start work within two weeks

Column 117
PAGE 1 OF 1

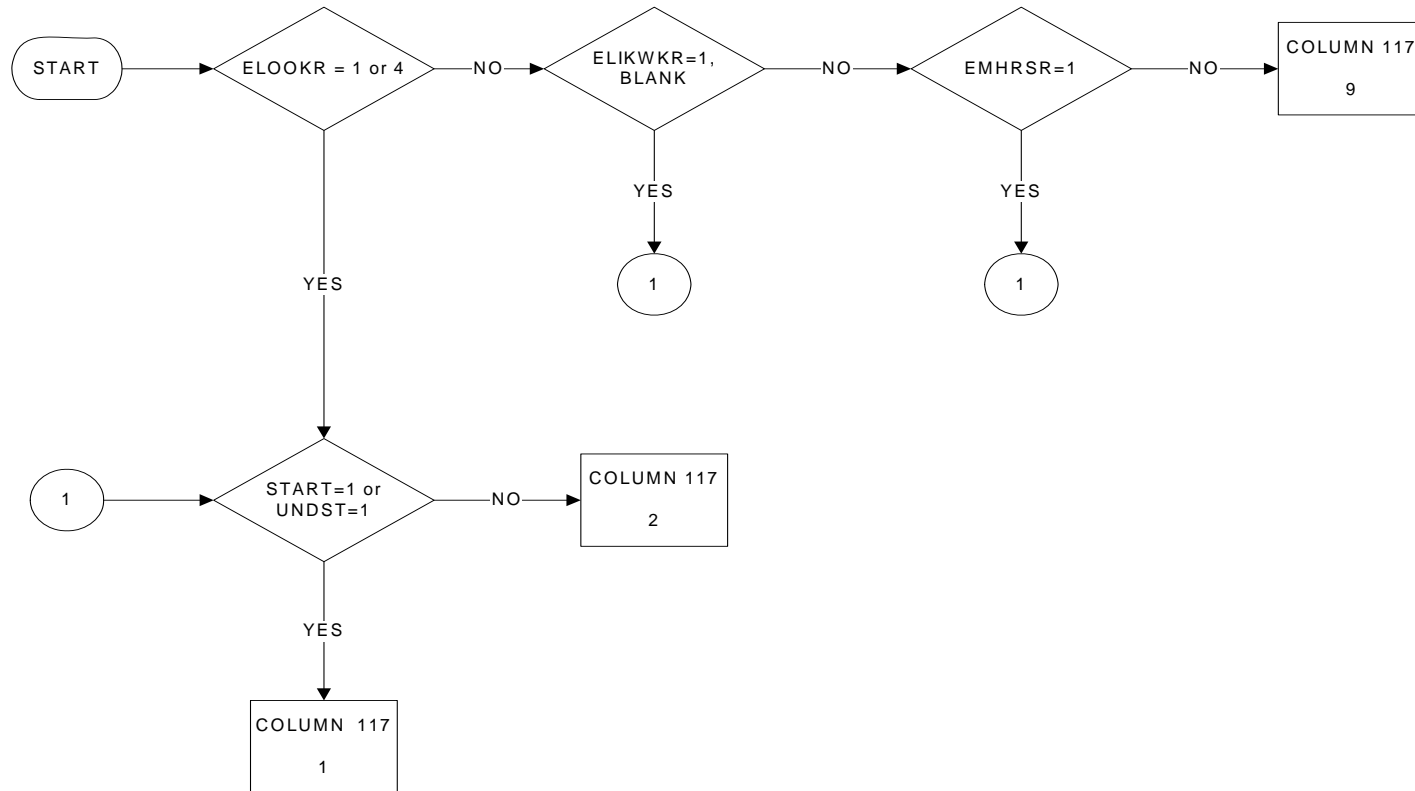

KEY

- 1 Person could start to work immediately (within 2 weeks)
- 2 Person could not start to work immediately (within 2 weeks)
- 9 Not applicable (SEEKWORK ? 1, 4 and WANTWORK ? 1, BLANK and WISHMORE ? 1)

AVAIRES (EVALREA): Reasons for not being available to start work within two weeks

Column 118
PAGE 1 OF 1

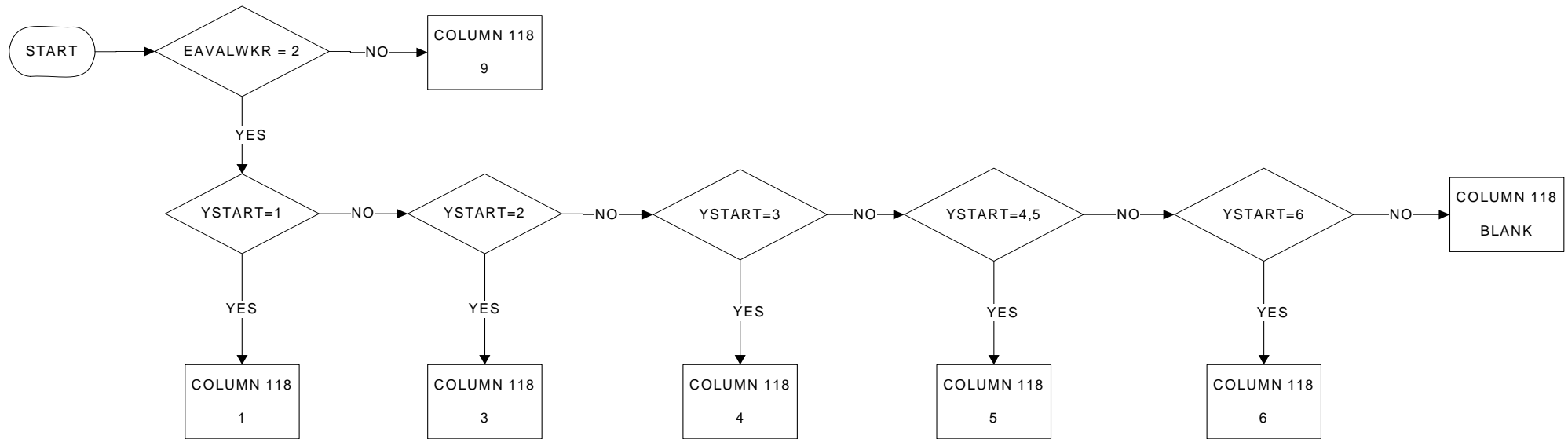

KEY

- 1 He/she must complete education or training
- 2 He/she must complete compulsory military or community service
- 3 He/she cannot leave present employment within two weeks due to period of notice
- 4 Of personal or family responsibilities (including maternity)
- 5 Of own illness or incapacity
- 6 Of other reasons
- 9 Not applicable (AVAILBLE ? 2)
- BLANK No answer

PRESEEK (EBEFORER): Situation immediately before seeking work

Column 119
PAGE 1 OF 1

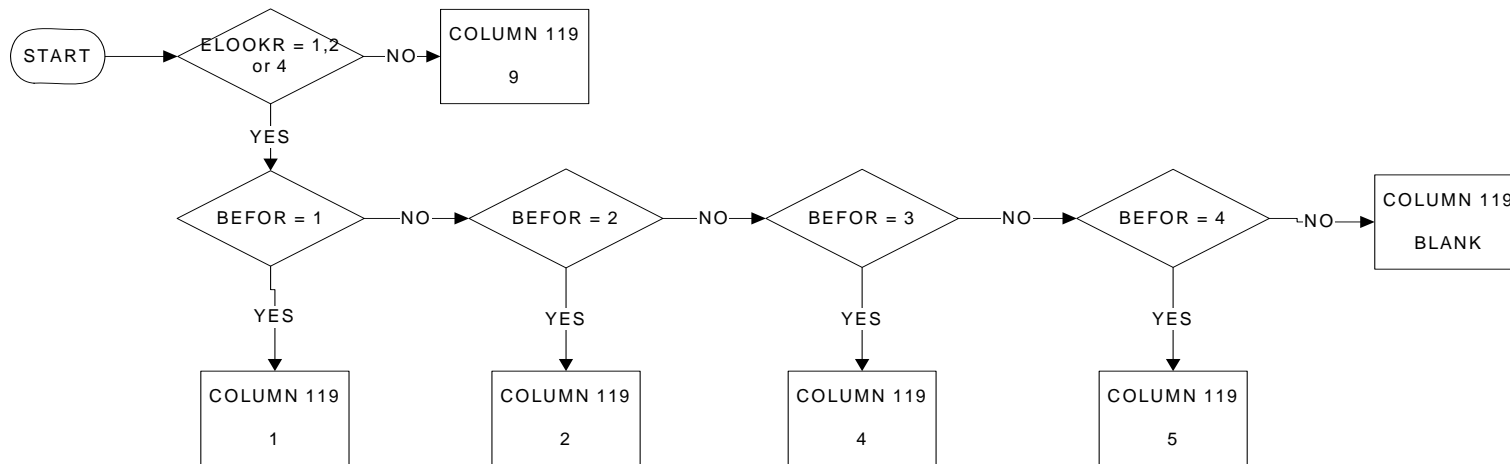

| KEY | |
|-------|---|
| 1 | Person was working (including apprentices, trainees) |
| 2 | Person was in full-time education (excluding apprentices, trainees) |
| 3 | Person was conscript on compulsory military or community service |
| 4 | Person had domestic/family responsibilities |
| 5 | Other (e.g. retired) |
| 9 | Not applicable (SEEKWORK =3,9) |
| BLANK | No answer |

ENECARE: Need for care facilities

Column 120
PAGE 1 OF 1

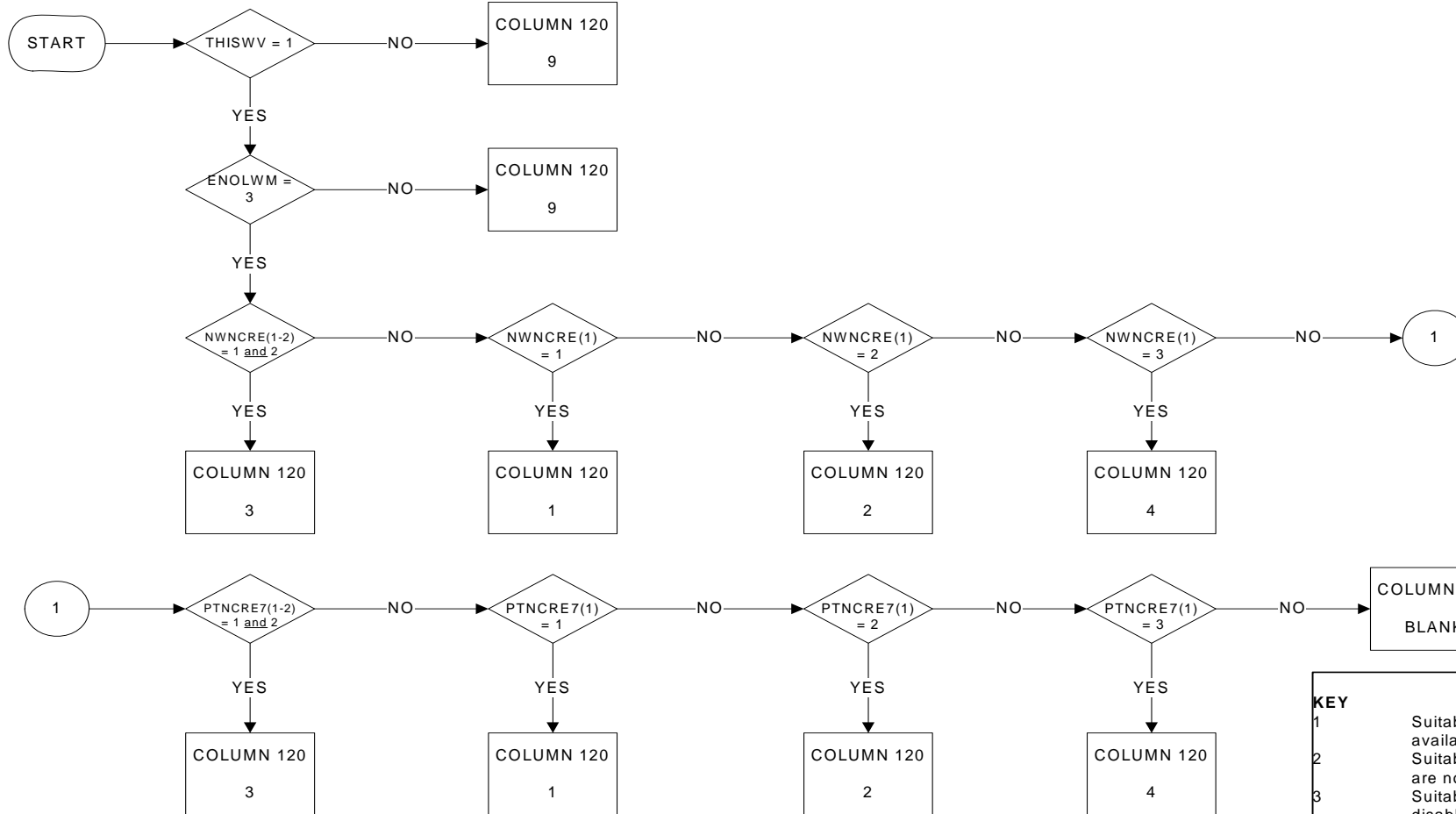

KEY

- 1 Suitable care services for children are not available or affordable
- 2 Suitable care services for ill, disabled, elderly are not available or affordable
- 3 Suitable care services for both children and ill, disabled and elderly are not available or affordable
- 4 Care facilities do not influence decision for working part time or not searching for a job
- 9 Not applicable (ENOLWM NE 3 or THISWV NE 1)
- Blank No answer

REGISTER (EREGPUB): Registration at a Public Employment Office

Column 121
PAGE 1 OF 1

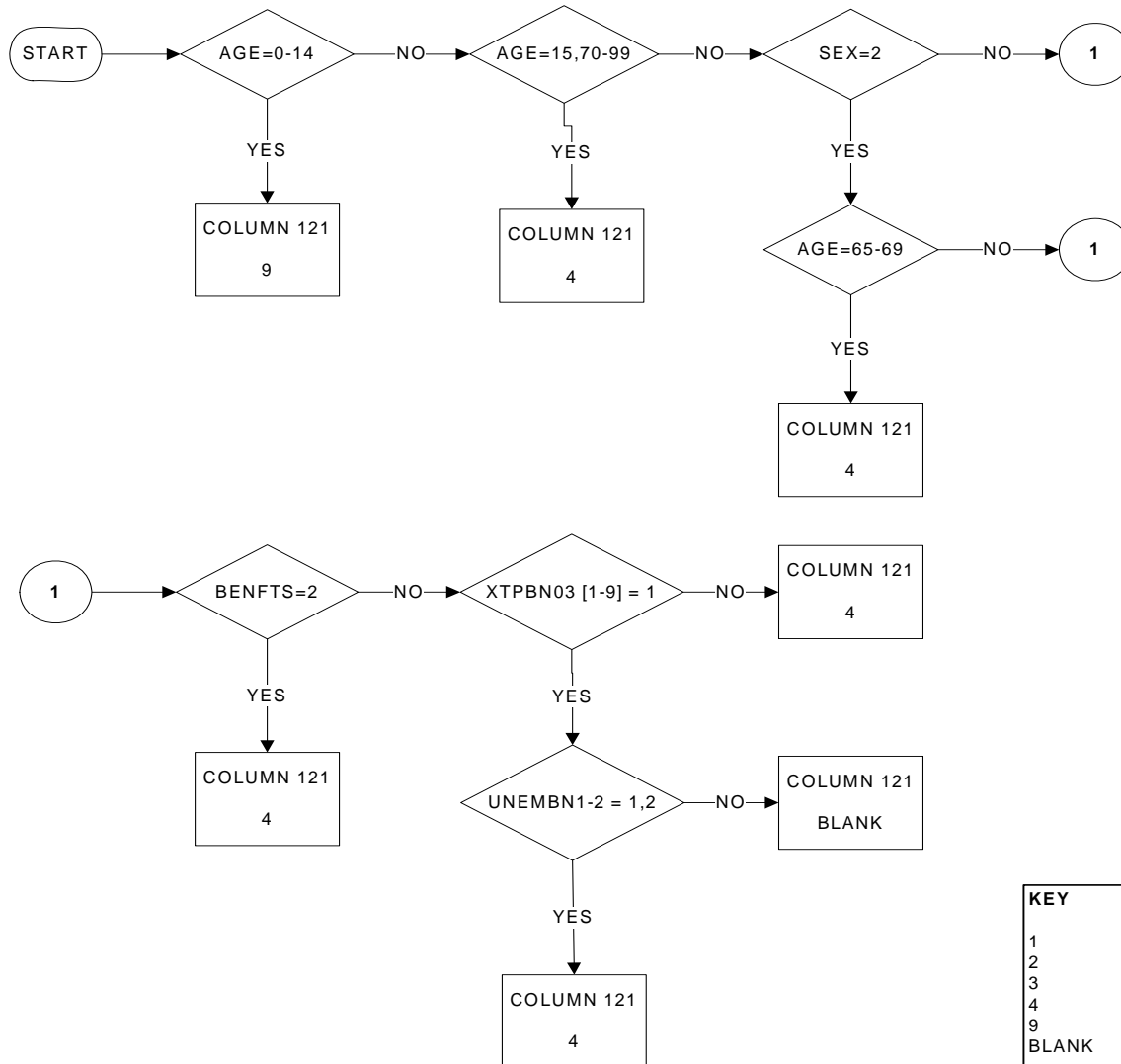

KEY

- 1 Person is registered at a public employment office and receives benefit or assistance
- 2 Person is registered at a public employment office but does not receive benefit or assistance
- 3 Person is not registered at a public employment office but receives benefit or assistance
- 4 Person is not registered at a public employment office and does not receive benefit or assistance
- 9 Not applicable (person aged less than 15 years or older than 75)
- BLANK No answer

EDUCSTAT (EDUCSTA): Student or apprentice in regular education during last four weeks

Column 123
PAGE 1 OF 1

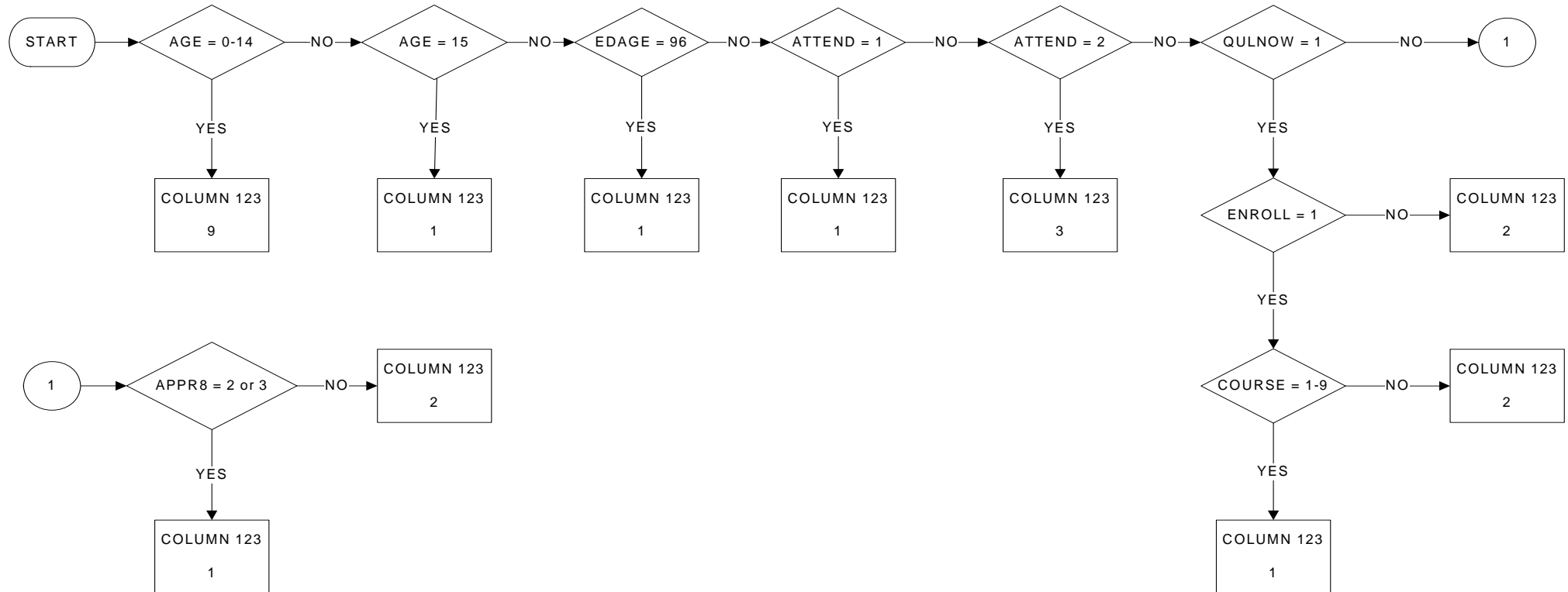

| KEY | |
|-------|---|
| 1 | Has been a student or an apprentice |
| 2 | Has not been a student or apprentice |
| 3 | Person in regular education but on holidays |
| 9 | Not applicable (child less than 15 years) |
| BLANK | No answer |

EDUCLEVEL (EDUCLEV): Level of the current education or training

Column 124
PAGE 1 OF 2

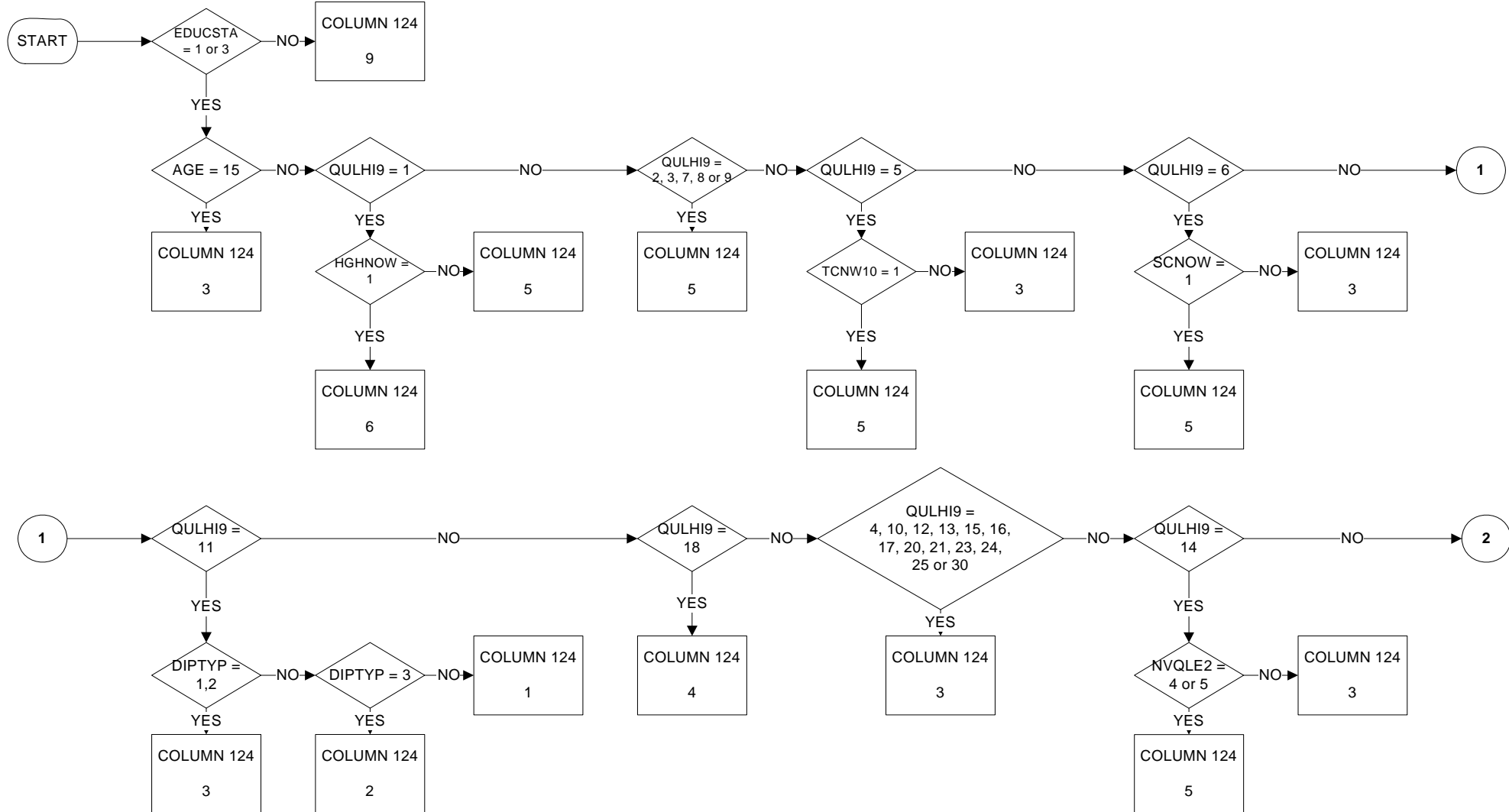

EDUCLEVEL (EDUCLEV): Level of the current education or training

Column 124

PAGE 2 OF 2

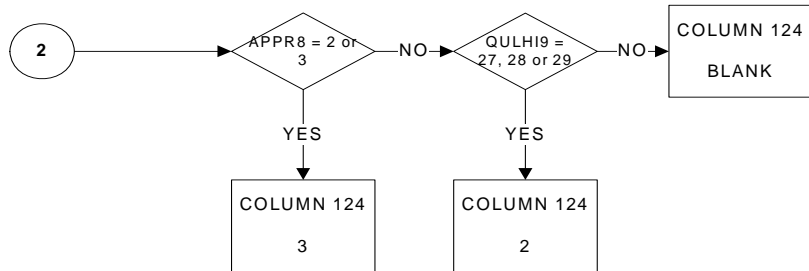

| KEY | |
|---|---|
| 1 | ISCED 1 |
| 2 | ISCED 2 |
| 3 | ISCED 3 |
| 4 | ISCED 4 |
| 5 | ISCED 5 |
| 6 | ISCED 6 |
| 9 | Not applicable (EDUCSTAT = 2, 9 or BLANK) |
| BLANK | No answer |
| Notes | |
| HGHNOW was quarterly specific (spring and Autumn), but was changed to being all quarters from D03F. | |

EDUCFILD (EDUCFLD): Field of this education or training

Columns 125/127

PAGE 1 OF 2

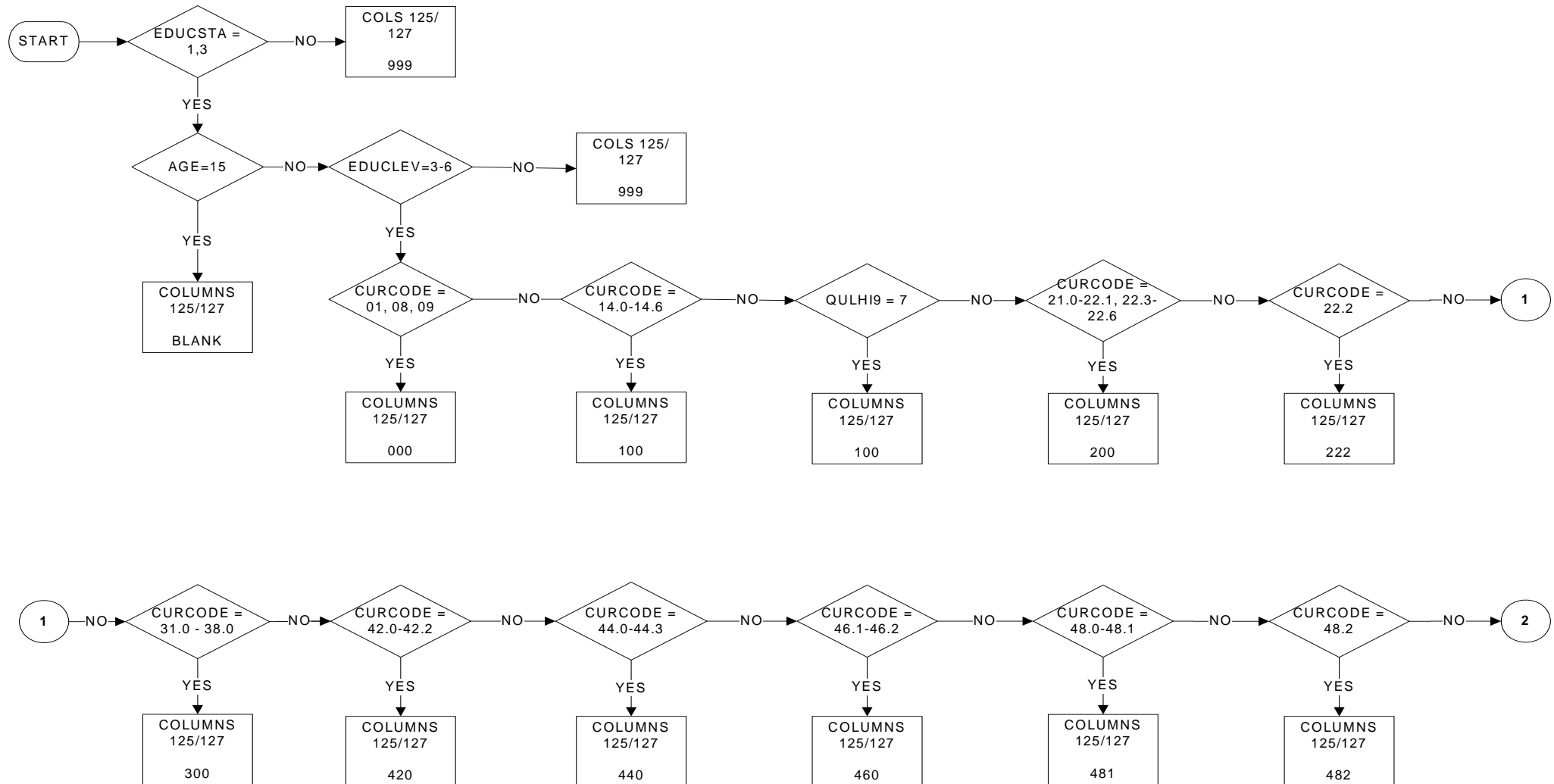

EDUCFILD (EDUCFLD): Field of this education or training

Columns 125/127

PAGE 2 OF 2

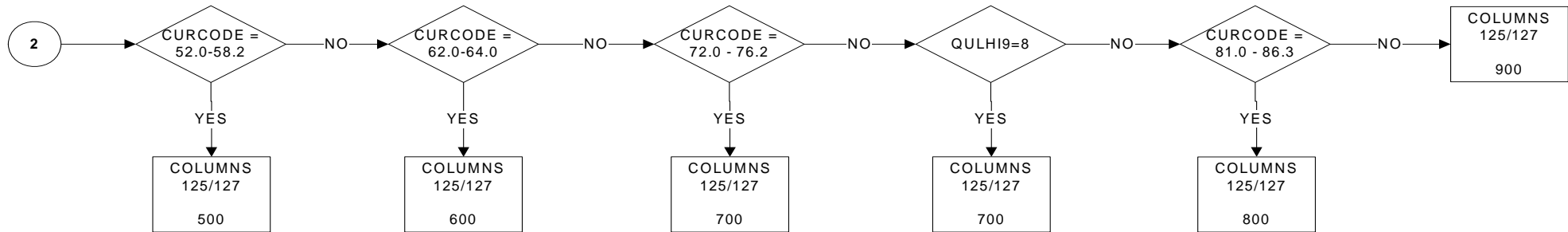

KEY

| | |
|-------|---|
| 000 | General programmes |
| 100 | Teacher training and education science |
| 200 | Humanities, language and arts |
| 222 | Foreign languages |
| 300 | Social science, business and law |
| 400 | Science, mathematics and computing |
| 420 | Life science (including biology and environmental science) |
| 440 | Physical science (including physics, chemistry and earth science) |
| 460 | Mathematics and statistics |
| 481 | Computer science |
| 482 | Computer use |
| 500 | Engineering, manufacturing and construction |
| 600 | Agriculture and veterinary |
| 700 | Health and welfare |
| 800 | Services |
| 900 | unknown |
| 999 | Not applicable (EDUCSTAT =2,9 BLANK or EDUCLEVL = 3-6) |
| BLANK | No answer |

Notes

CURCODE values output as string not numeric, see attached coding frame

COURATT (ECOURA): Attendance at courses, seminars, private lessons etc outside regular education within last four weeks

Column 128
PAGE 1 OF 1

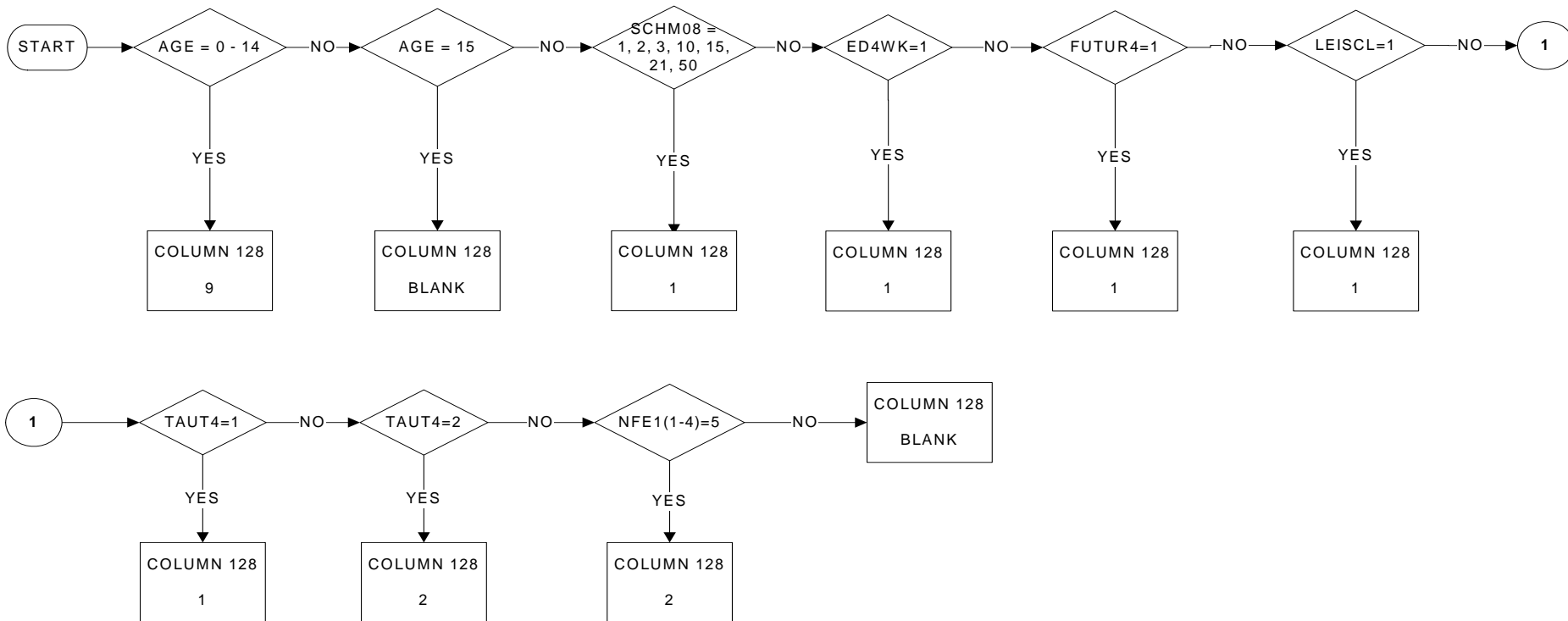

| KEY | |
|-------|---|
| 1 | Yes |
| 2 | No |
| 9 | Not applicable (child less than 15 years) |
| blank | No answer |

COURLEN (ECOURL): Number of hours spent on all taught learning activities within the last four weeks

Columns 129/131

PAGE 1 OF 1

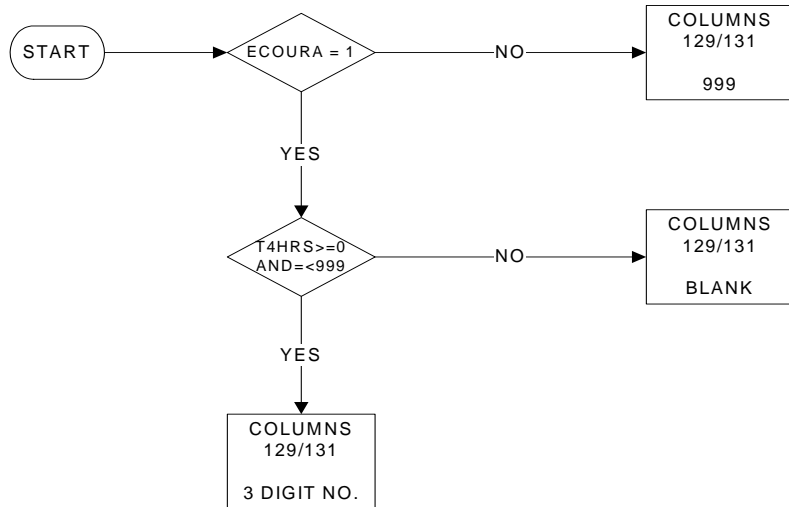

| KEY | |
|----------|--|
| 3 digits | Number of hours |
| 999 | Not applicable (COURATT = 2, 9, blank) |
| blank | No answer |

COURPURP (ECOURP): Purpose of the most recent taught learning activity

Column 132
PAGE 1 OF 1

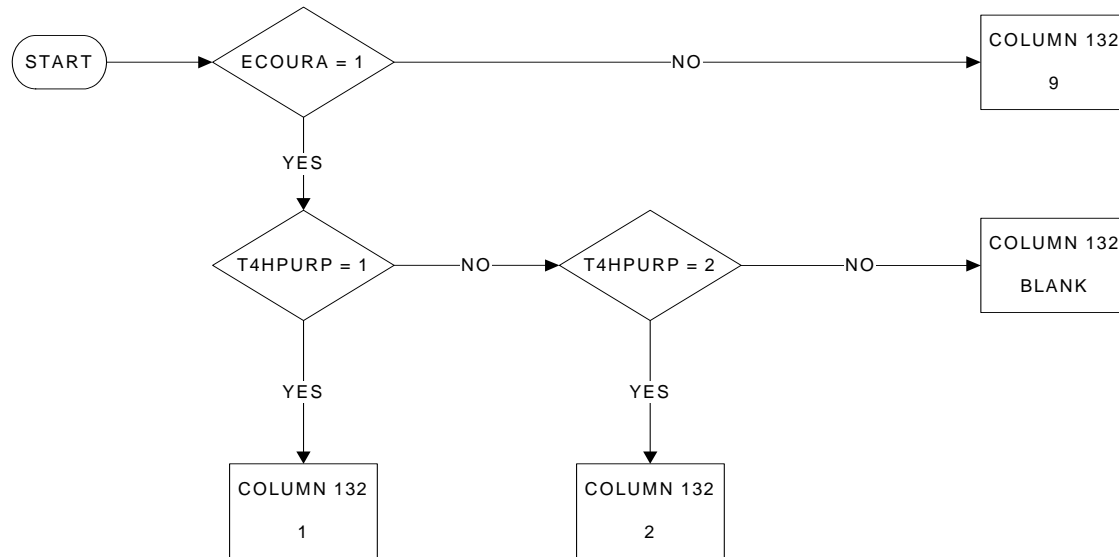

| KEY | |
|-------|--------------------------------------|
| 1 | Mostly job related (professional) |
| 2 | Mostly personal/social |
| 9 | Not applicable (COURATT = 2,9,blank) |
| blank | No answer |

COURFILD (ECOURF): Field of the most recent taught learning activity

Column 133/135

PAGE 1 OF 2

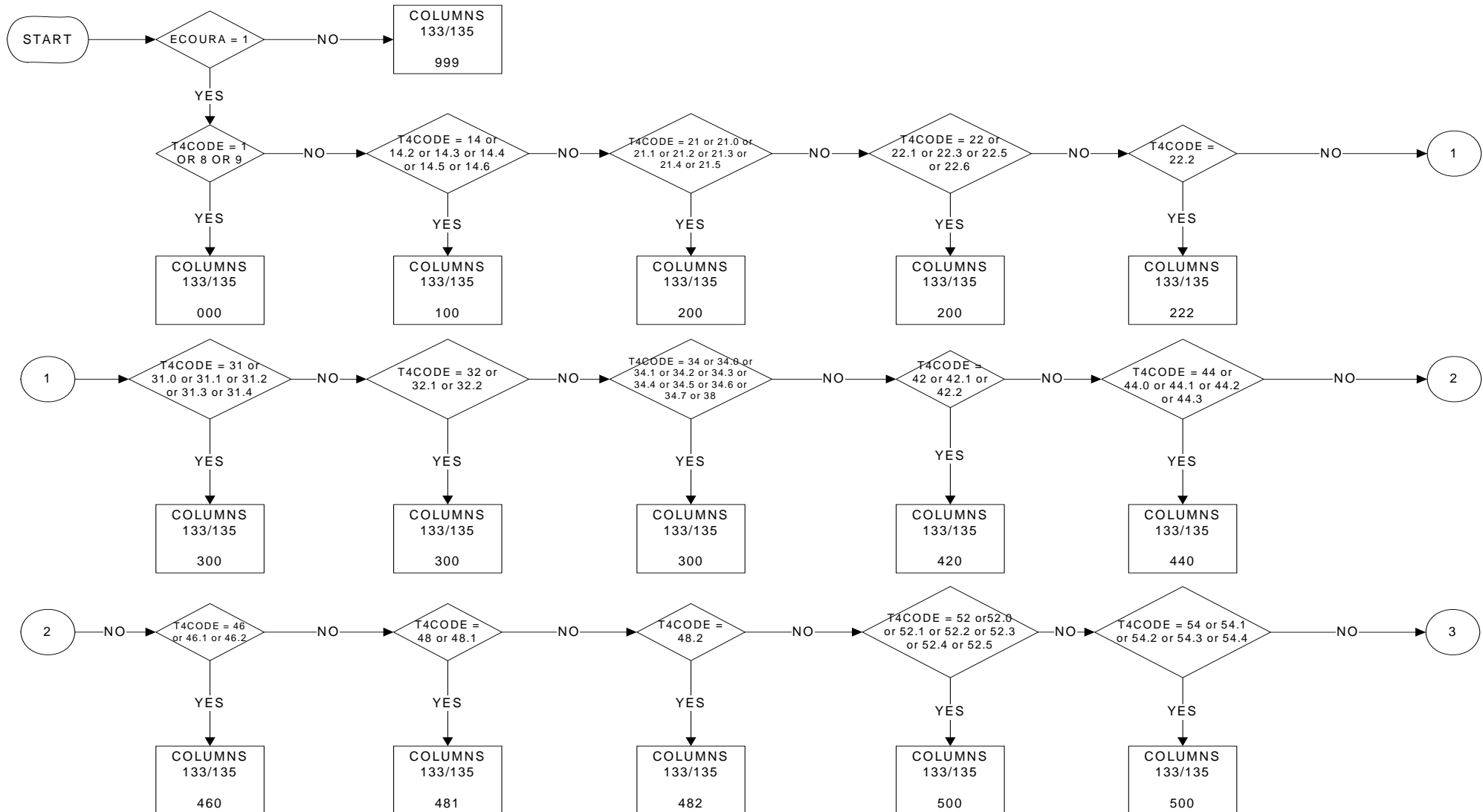

COURFILD (ECOURF): Field of the most recent taught learning activity

Column 133/135

PAGE 2 OF 2

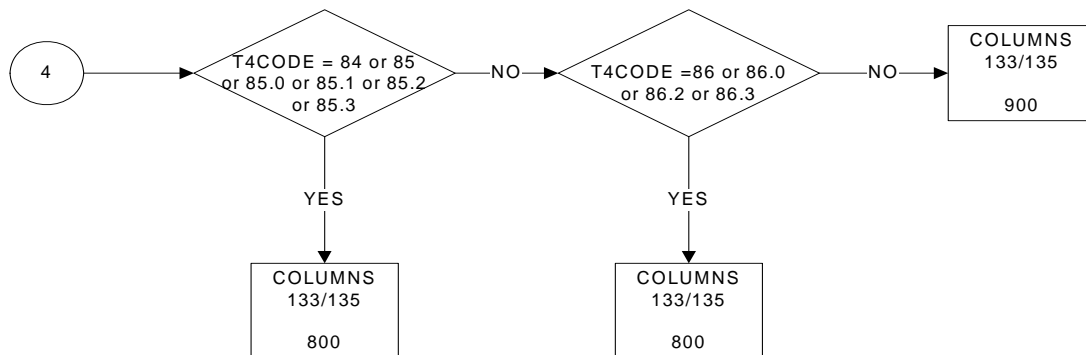
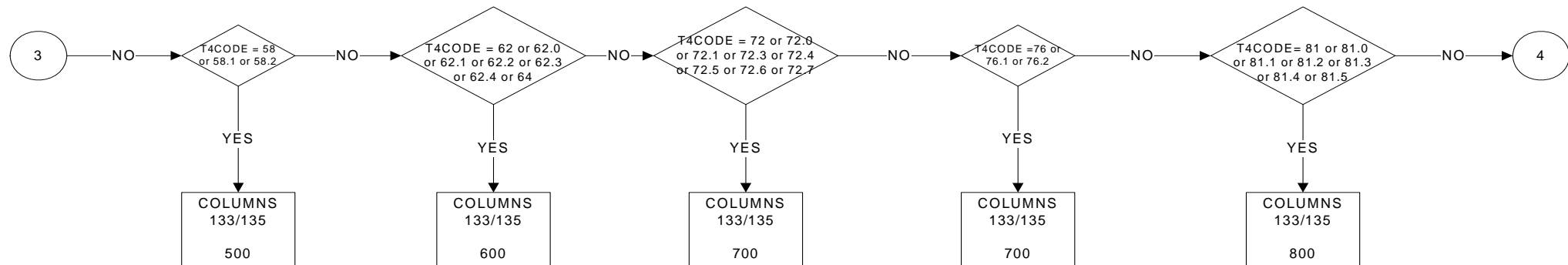

| KEY | |
|-------|---|
| 000 | General programmes |
| 100 | Teacher training and education science |
| 200 | Humanities, languages and arts |
| 222 | Foreign languages |
| 300 | Social sciences, business and law |
| 400 | Science, mathematics and computing |
| 420 | Life science (including biology and environmental science) |
| 440 | Physical science (including physics, chemistry and earth science) |
| 460 | Mathematics and statistics |
| 481 | Computer science |
| 482 | Computer use |
| 500 | Engineering, manufacturing and construction |
| 600 | Agriculture and veterinary |
| 700 | Health and welfare |
| 800 | Services |
| 900 | Unknown |
| 999 | Not applicable (COURATT = 2, 9, blank) |
| blank | No answer |

COURWORK (ECOURW): Whether recent taught learning activity took place during paid working hours

Column 136
PAGE 1 OF 1

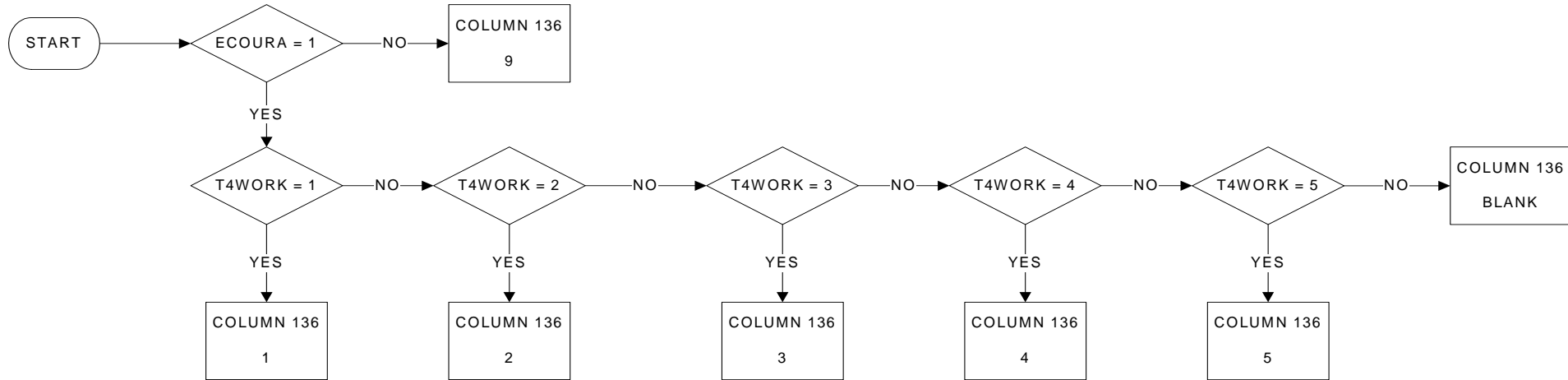

| KEY | |
|-------|--------------------------------------|
| 1 | Only during paid working hours |
| 2 | Mostly during paid working hours |
| 3 | Mostly outside paid working hours |
| 4 | Only outside paid working hours |
| 5 | No job at that time |
| 9 | Not applicable (COURATT = 2,9,blank) |
| blank | No answer |

HATLEVEL (EHATLEV): Highest level of education or training successfully completed

Columns 137/138

PAGE 1 OF 1

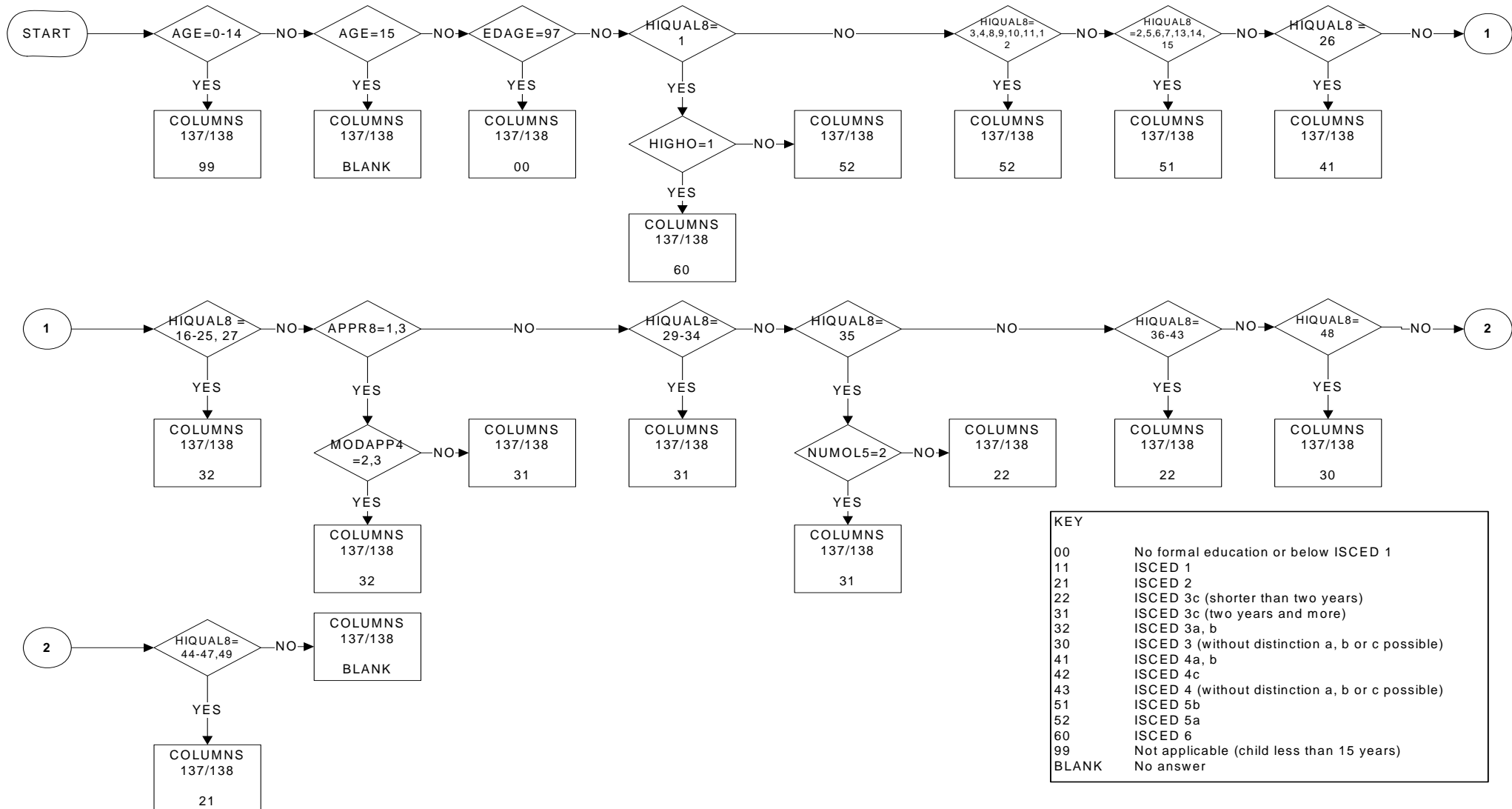

| KEY | |
|-------|--|
| 00 | No formal education or below ISCED 1 |
| 11 | ISCED 1 |
| 21 | ISCED 2 |
| 22 | ISCED 3c (shorter than two years) |
| 31 | ISCED 3c (two years and more) |
| 32 | ISCED 3a, b |
| 30 | ISCED 3 (without distinction a, b or c possible) |
| 41 | ISCED 4a, b |
| 42 | ISCED 4c |
| 43 | ISCED 4 (without distinction a, b or c possible) |
| 51 | ISCED 5b |
| 52 | ISCED 5a |
| 60 | ISCED 6 |
| 99 | Not applicable (child less than 15 years) |
| BLANK | No answer |

HATFIELD (EHATFLD): Field of highest level of education or training successfully completed

Columns 139/141

PAGE 1 OF 2

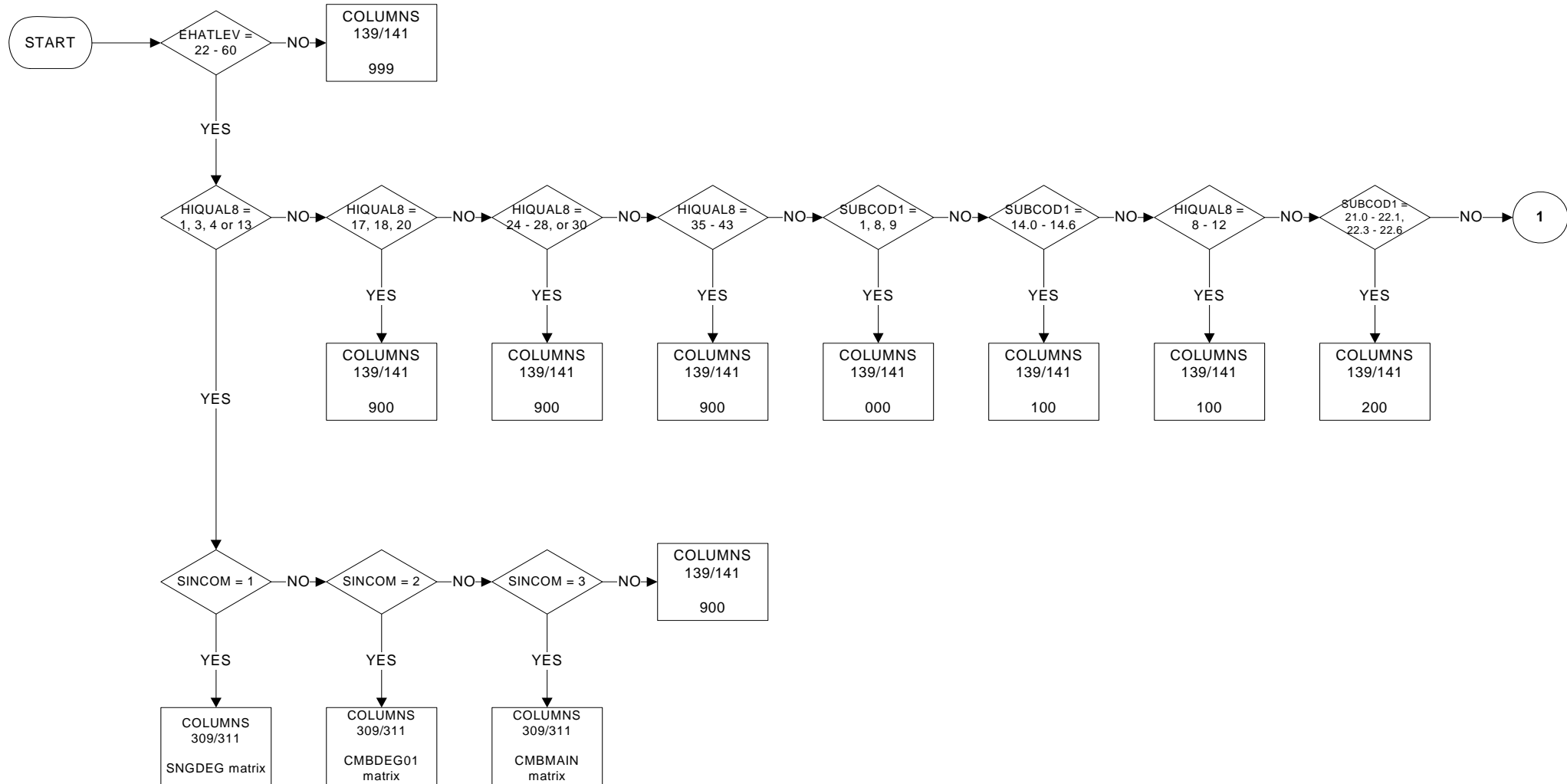

HATFIELD (EHATFLD): Field of highest level of education or training successfully completed

Columns 139/141

PAGE 2 OF 2

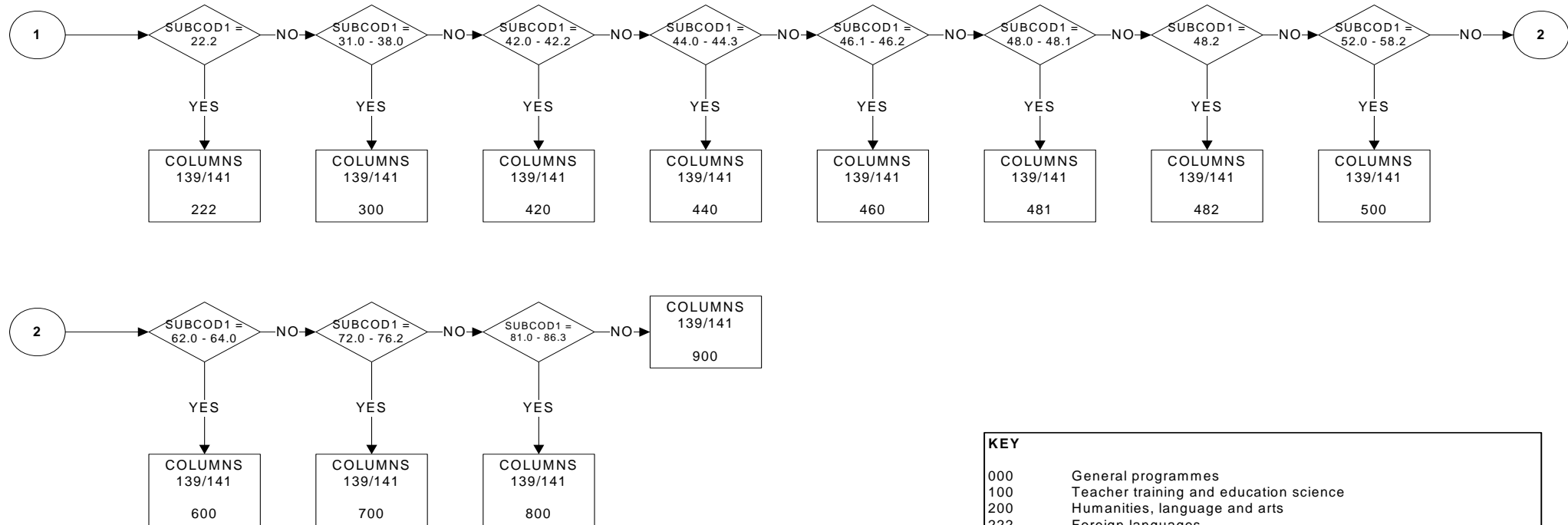

KEY

- 000 General programmes
- 100 Teacher training and education science
- 200 Humanities, language and arts
- 222 Foreign languages
- 300 Social science, business and law
- 400 Science, mathematics and computing
- 420 Life science (including biology and environmental science)
- 440 Physical science (including physics, chemistry and earth science)
- 460 Mathematics and statistics
- 481 Computer science
- 482 Computer use
- 500 Engineering, manufacturing and construction
- 600 Agriculture and veterinary
- 700 Health and welfare
- 800 Services
- 900 unknown
- 999 Not applicable (HATLEVEL = 00, 11, 21, 99, BLANK)
- BLANK No answer

Notes

SUBCOD1 values output as string not numeric, see attached coding frame.

HATYEAR (EHATYR): Year when highest level of education or training successfully completed

Columns 142/145

PAGE 1 OF 1

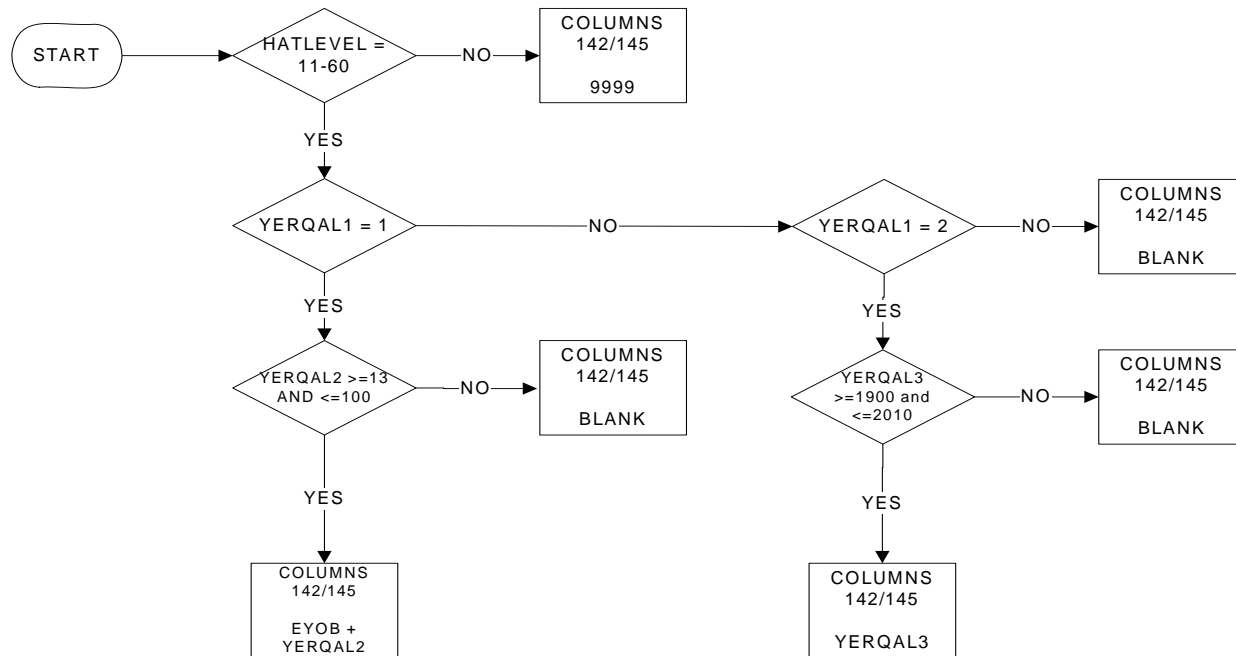

| KEY | |
|---|-----------------------------------|
| The 4 digits of year when highest level of education or training was successfully completed are entered | |
| 9999 | Not applicable (HATLEVEL = 11-60) |
| BLANK | No answer |

WSTAT1Y (ESITONE): Situation with regard to activity one year ago

Column 146
PAGE 1 OF 1

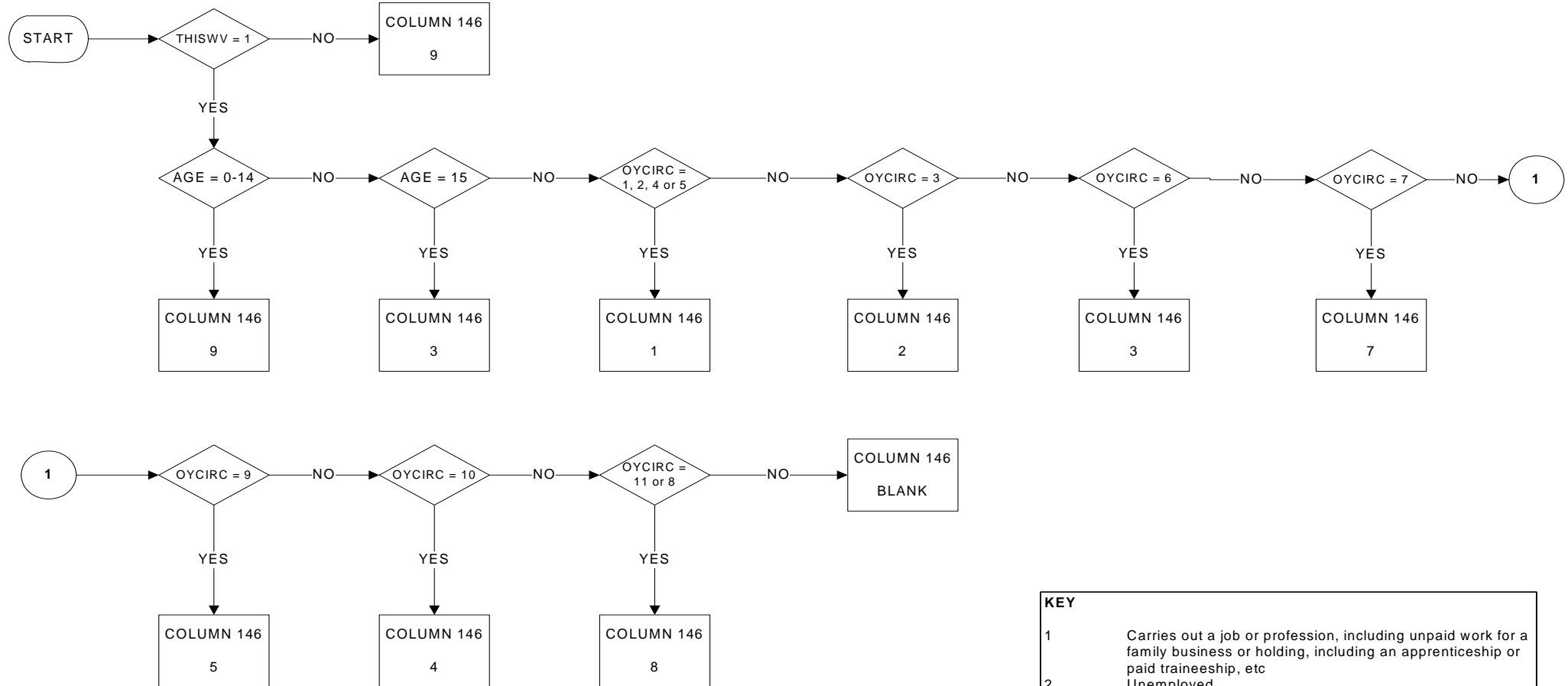

| KEY | |
|-------|---|
| 1 | Carries out a job or profession, including unpaid work for a family business or holding, including an apprenticeship or paid traineeship, etc |
| 2 | Unemployed |
| 3 | Pupil, student, further training, unpaid work experience |
| 4 | In retirement or early retirement or has given up business |
| 5 | Permanently disabled |
| 6 | In compulsory military service |
| 7 | Fulfilling domestic tasks |
| 8 | Other inactive person |
| 9 | Not applicable (child less than 15 years) |
| BLANK | No answer |

STAPRO1Y (ESTATOR): Professional status one year before survey

Column 147

PAGE 1 OF 1

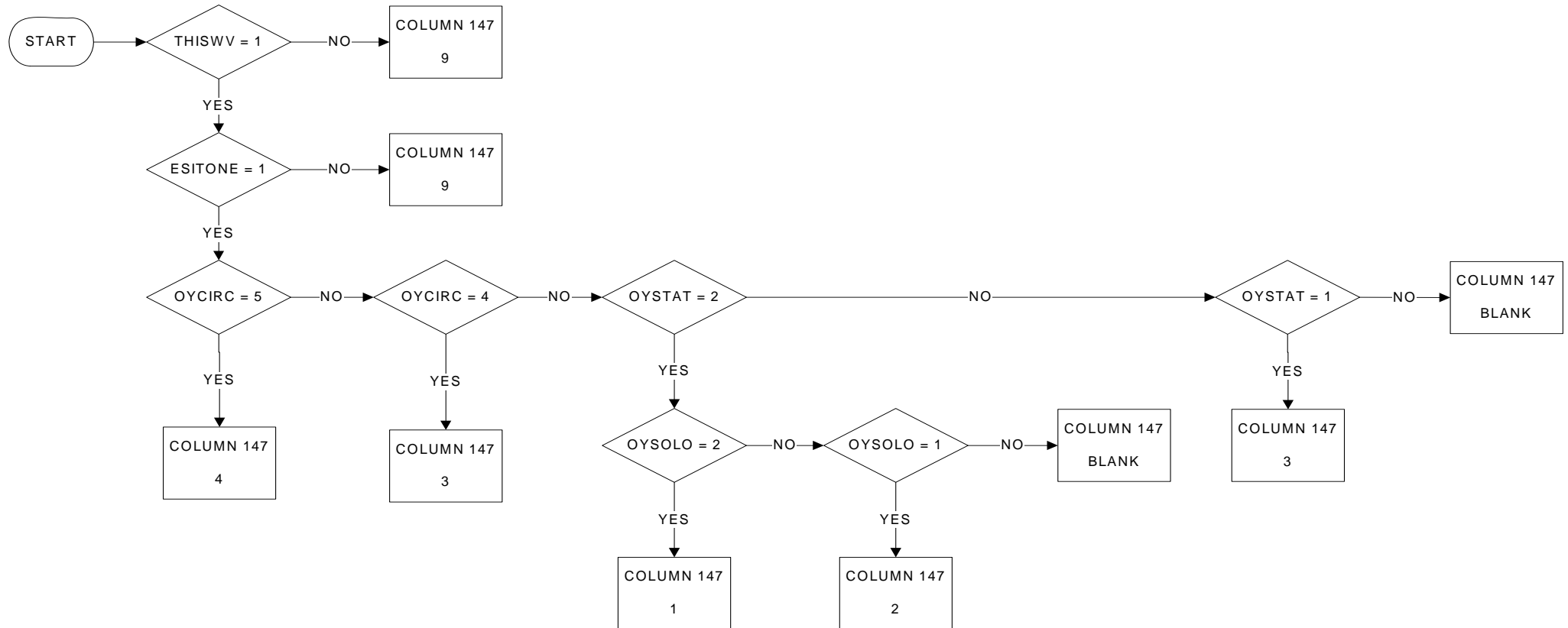

| KEY | |
|-------|---------------------------------|
| 1 | Self-employed with employees |
| 2 | Self-employed without employees |
| 3 | Employee |
| 4 | Family-worker |
| 9 | Not applicable (WSTAT1Y ? 1) |
| BLANK | No answer |

NACE1Y2D (ENACEO08): Economics activity of local unit in which person was working one year before survey

Column 148/149

PAGE 1 OF 1

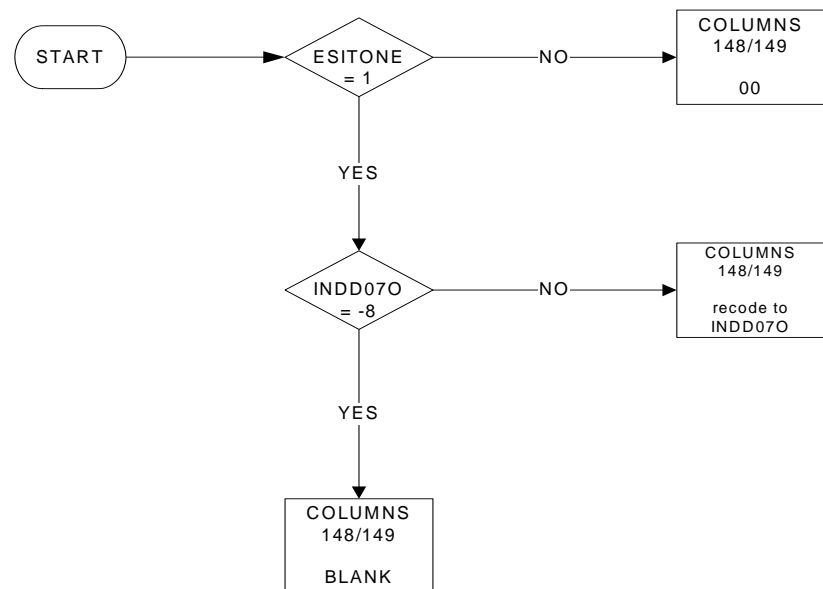

| KEY | |
|-------|------------------------------|
| | Nace Rev. 2 |
| 00 | Not applicable (WSTAT1Y ? 1) |
| Blank | No answer |

COUNTR1Y (ECTYO): Country of residence one year before survey

Columns 150/151

PAGE 1 OF 15

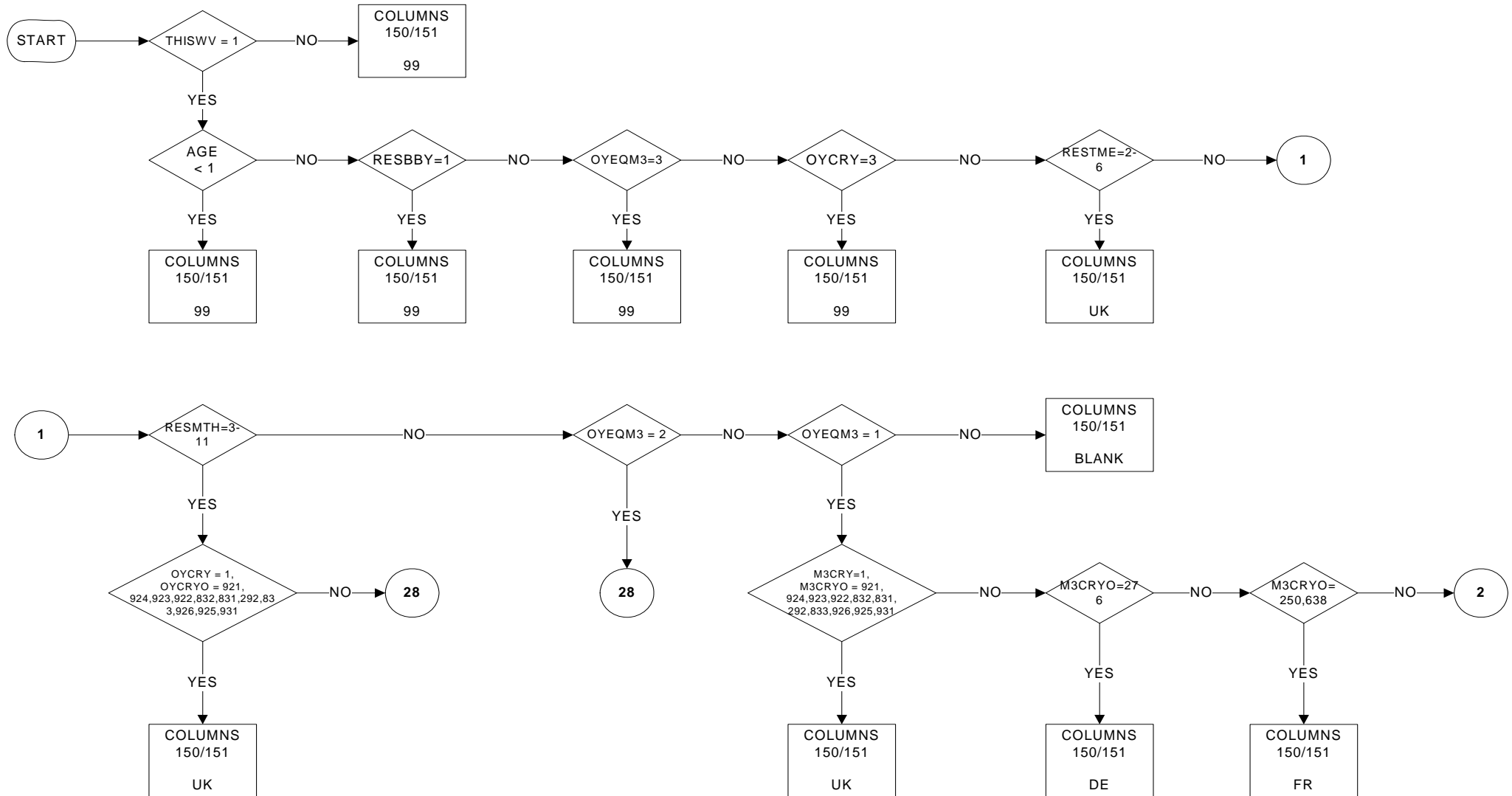

COUNTR1Y (ECTYO): Country of residence one year before survey

Columns 150/151

PAGE 2 OF 15

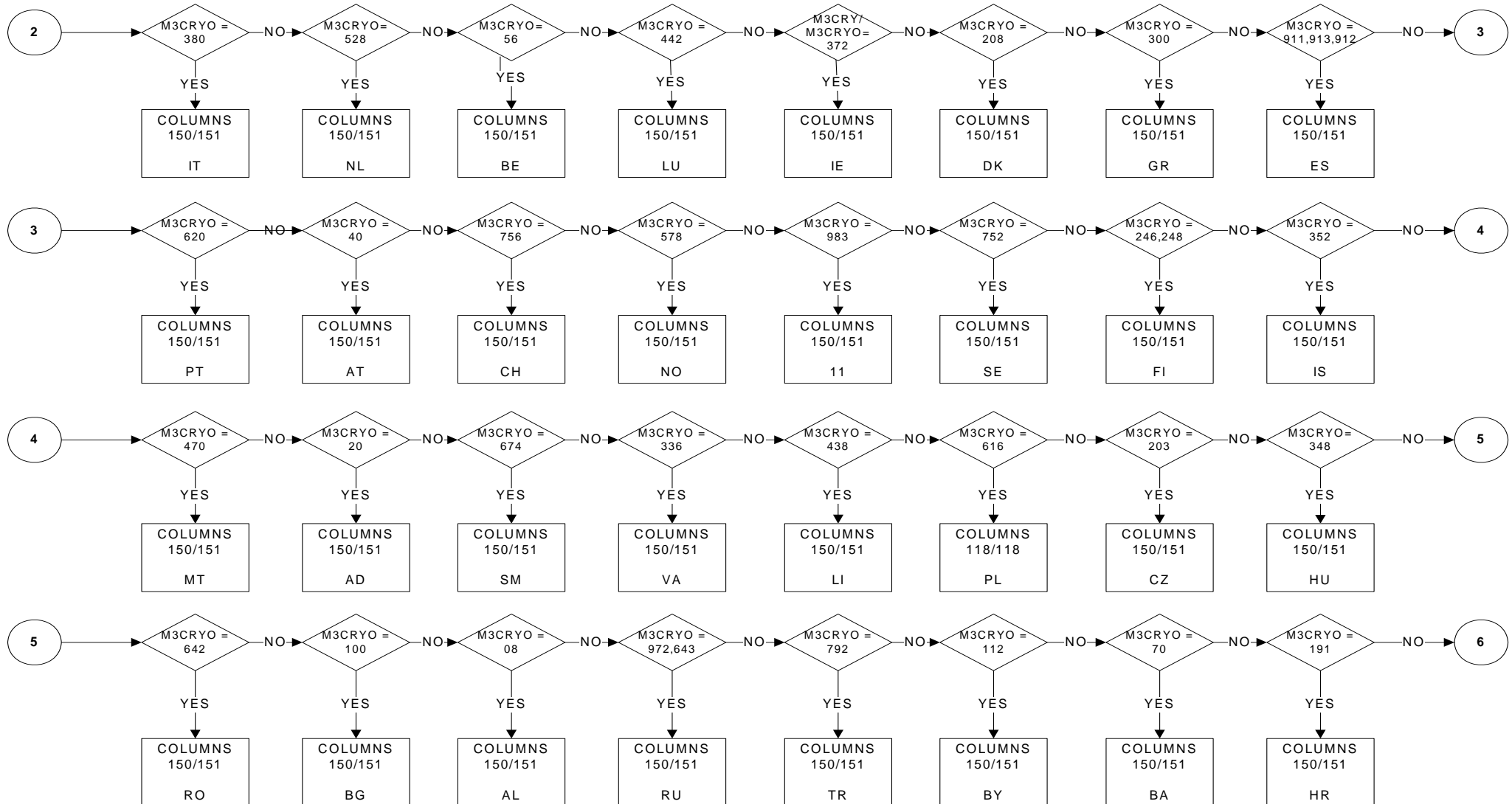

COUNTR1Y (ECTYO): Country of residence one year before survey

Columns 150/151

PAGE 3 OF 15

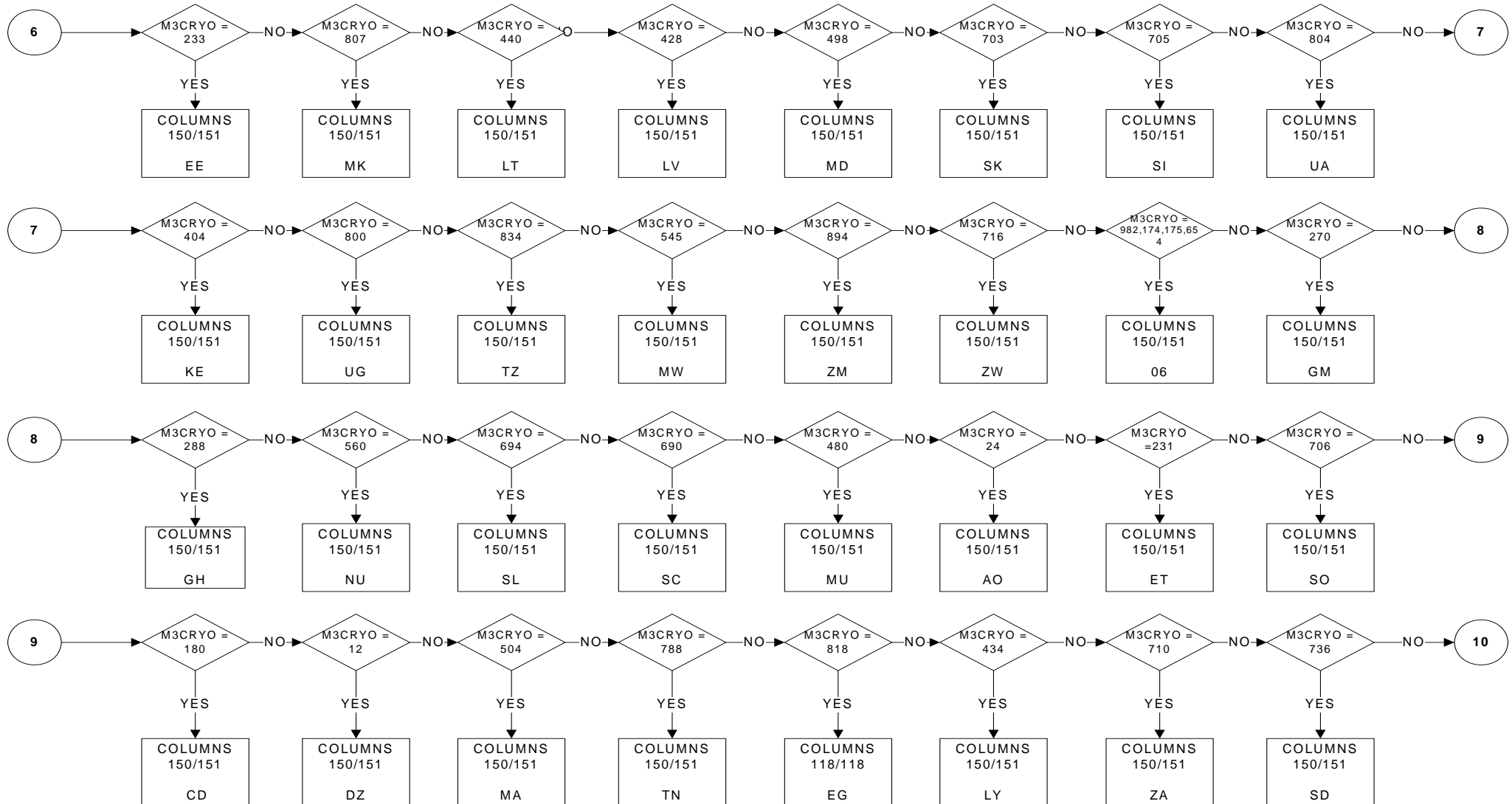

COUNTR1Y (ECTYO): Country of residence one year before survey

Columns 150/151

PAGE 4 OF 15

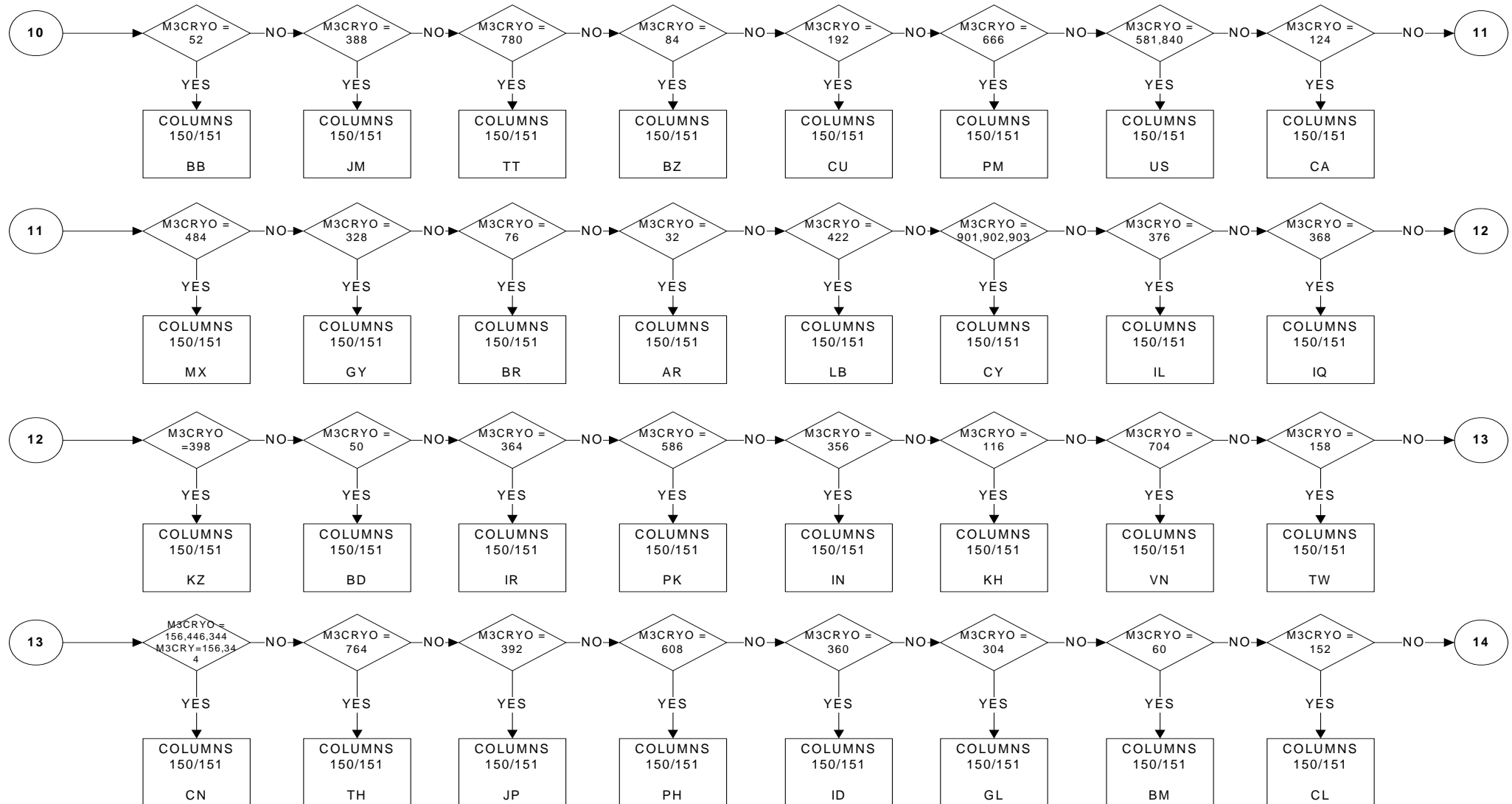

COUNTR1Y (ECTYO): Country of residence one year before survey

Columns 150/151

PAGE 5 OF 15

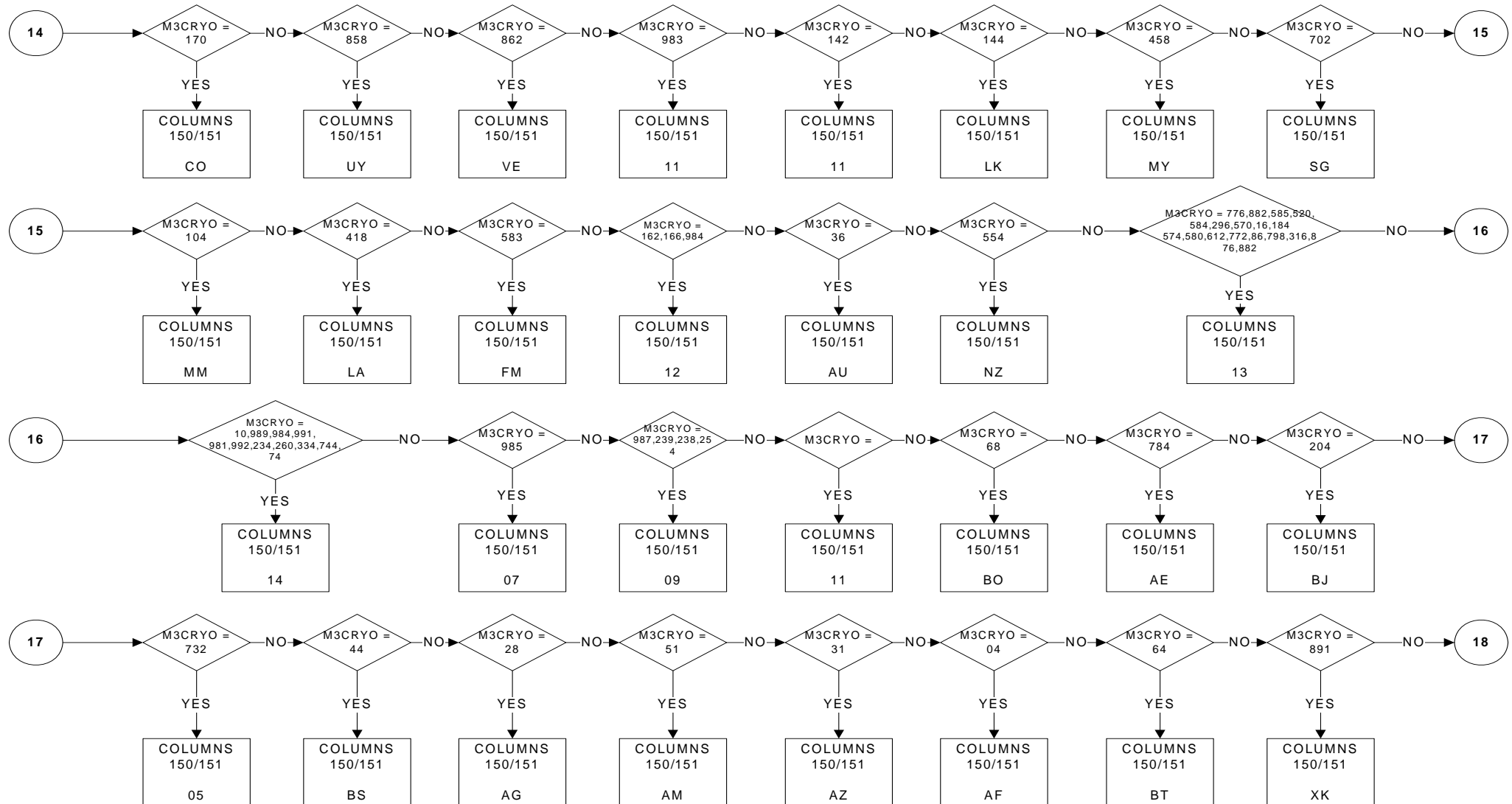

COUNTR1Y (ECTYO): Country of residence one year before survey

Columns 150/151

PAGE 6 OF 15

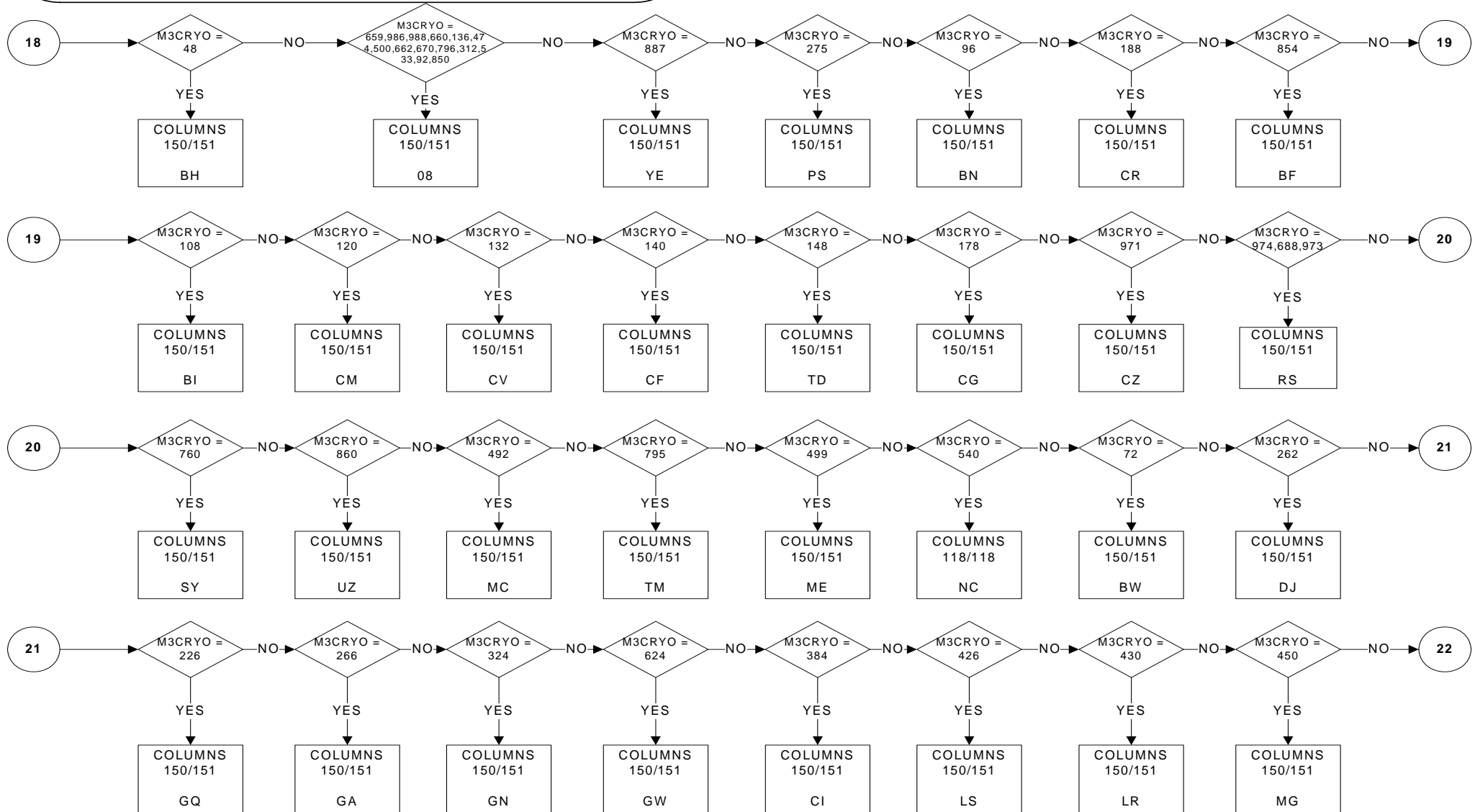

COUNTR1Y (ECTYO): Country of residence one year before survey

Columns 150/151

PAGE 7 OF 15

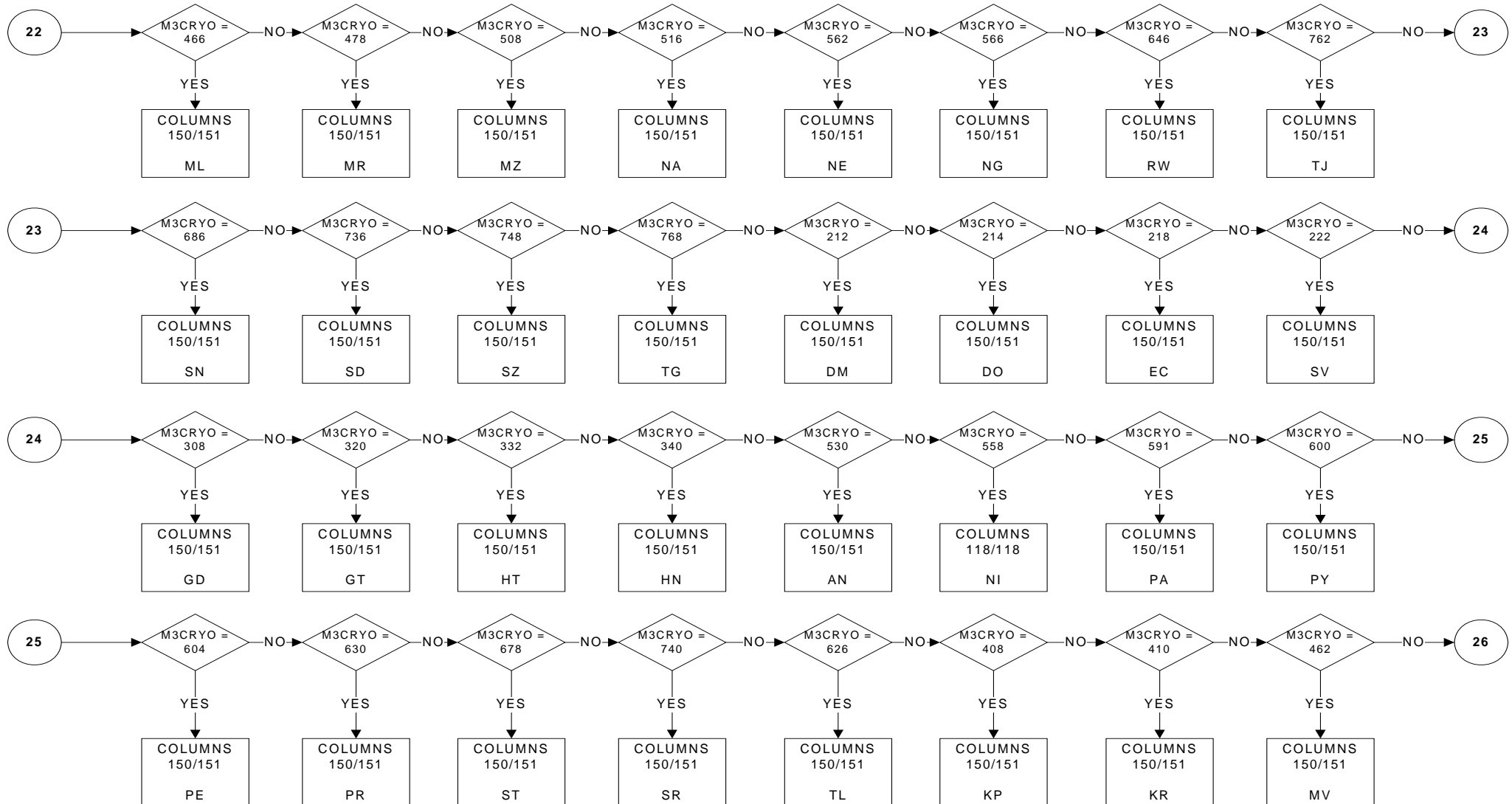

COUNTR1Y (ECTYO): Country of residence one year before survey

Columns 150/151

PAGE 8 OF 15

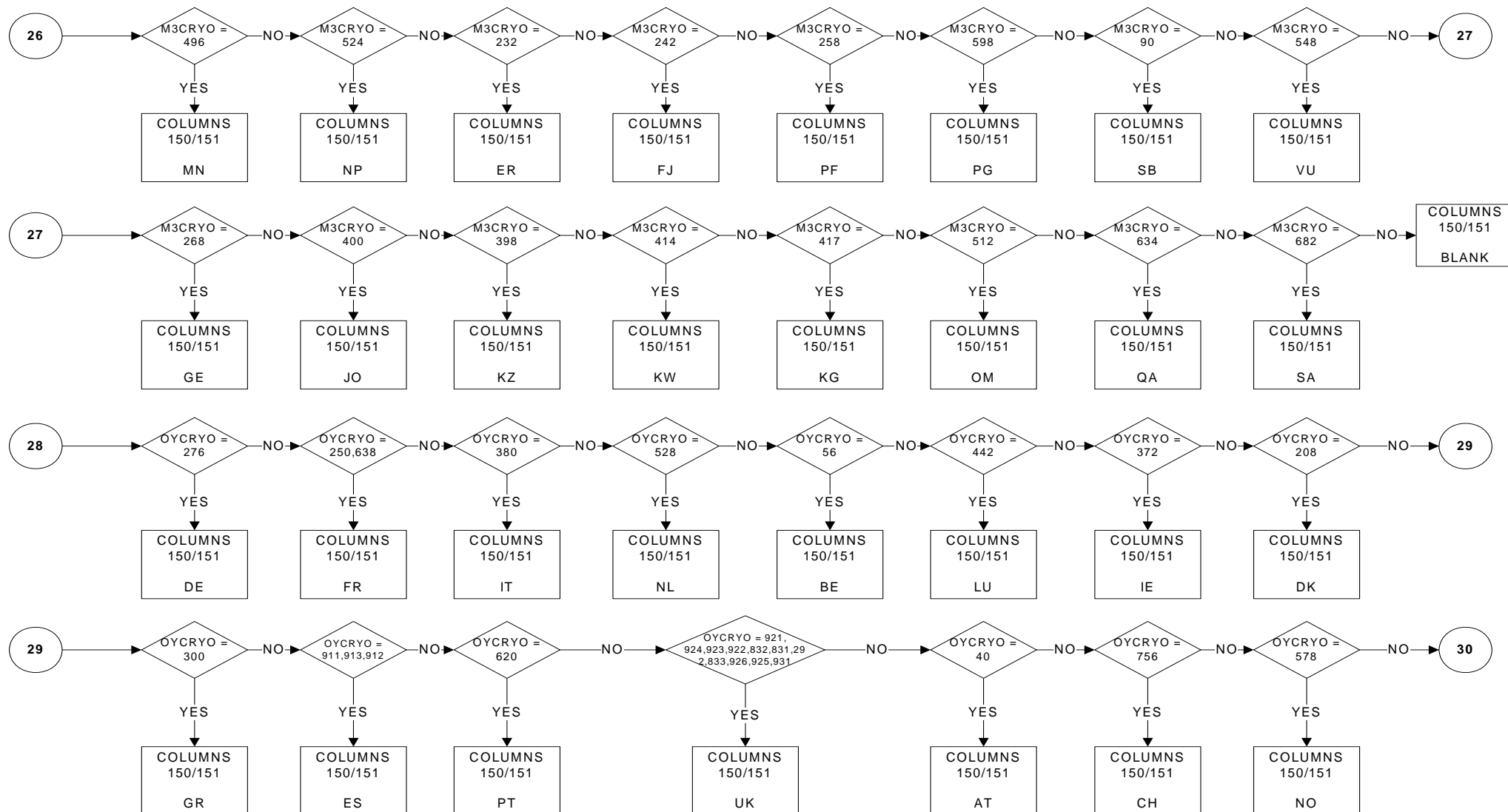

COUNTR1Y (ECTYO): Country of residence one year before survey

Columns 150/151

PAGE 9 OF 15

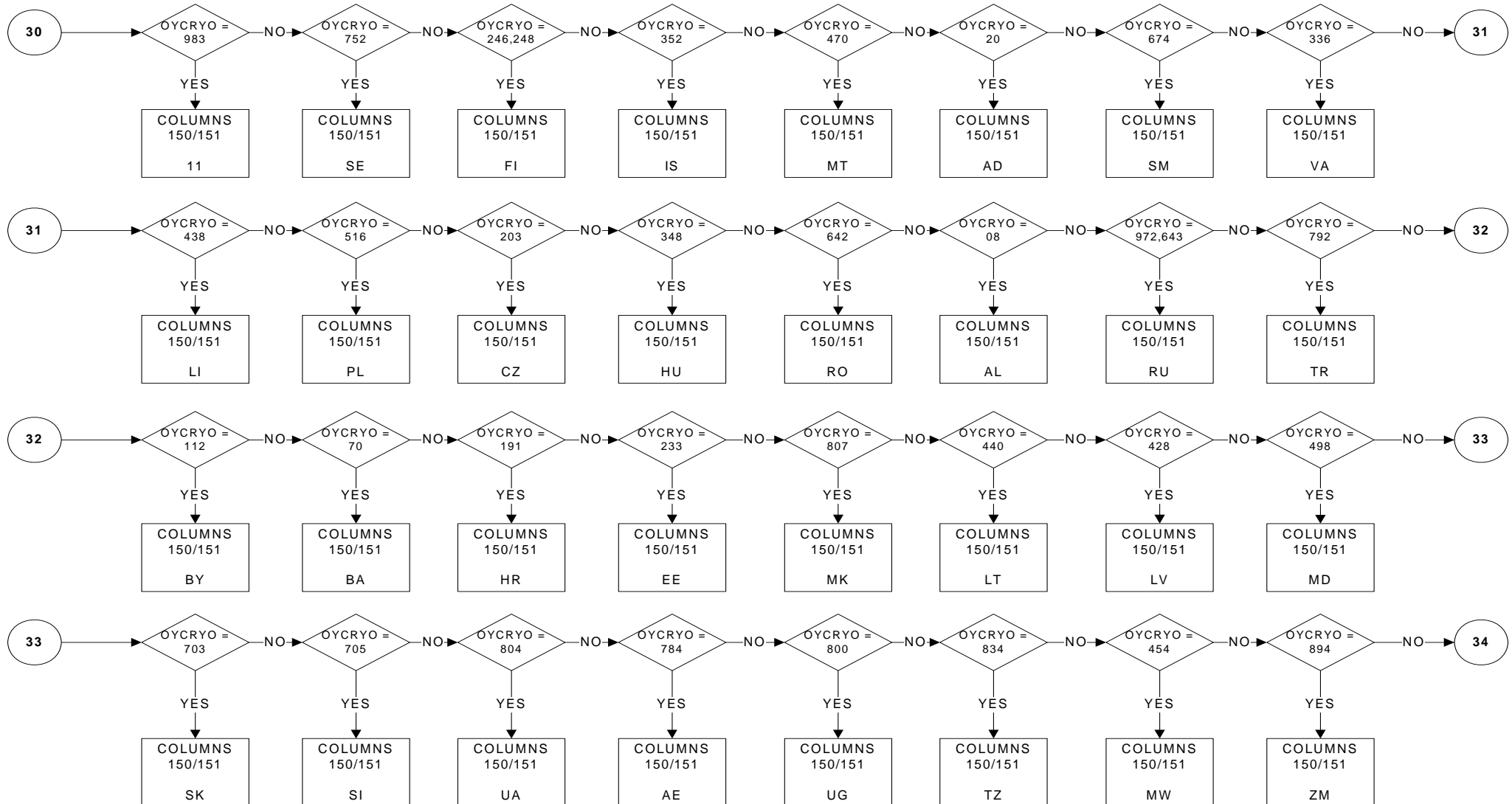

COUNTR1Y (ECTYO): Country of residence one year before survey

Columns 150/151

PAGE 10 OF 15

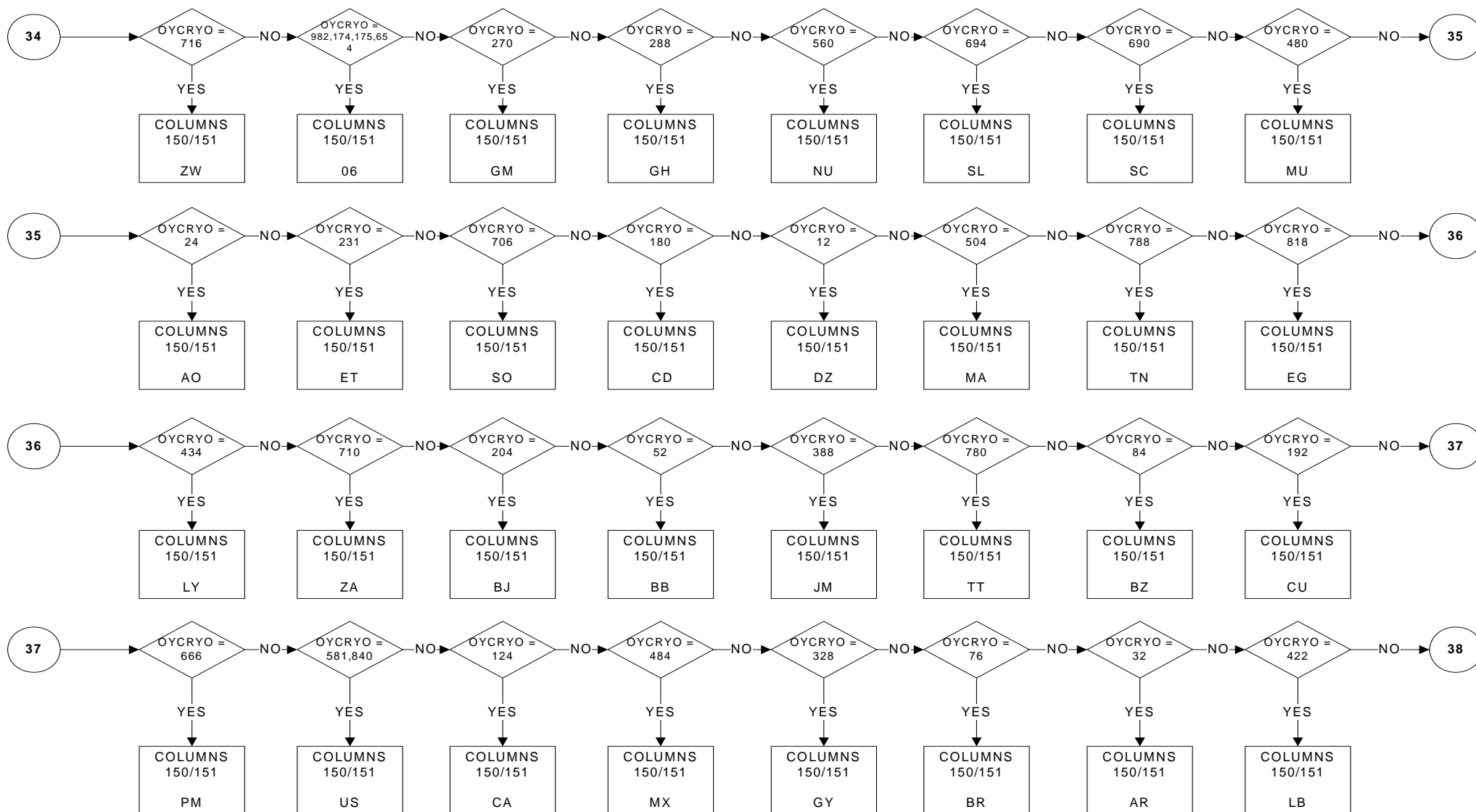

COUNTR1Y (ECTYO): Country of residence one year before survey

Columns 150/151

PAGE 11 OF 15

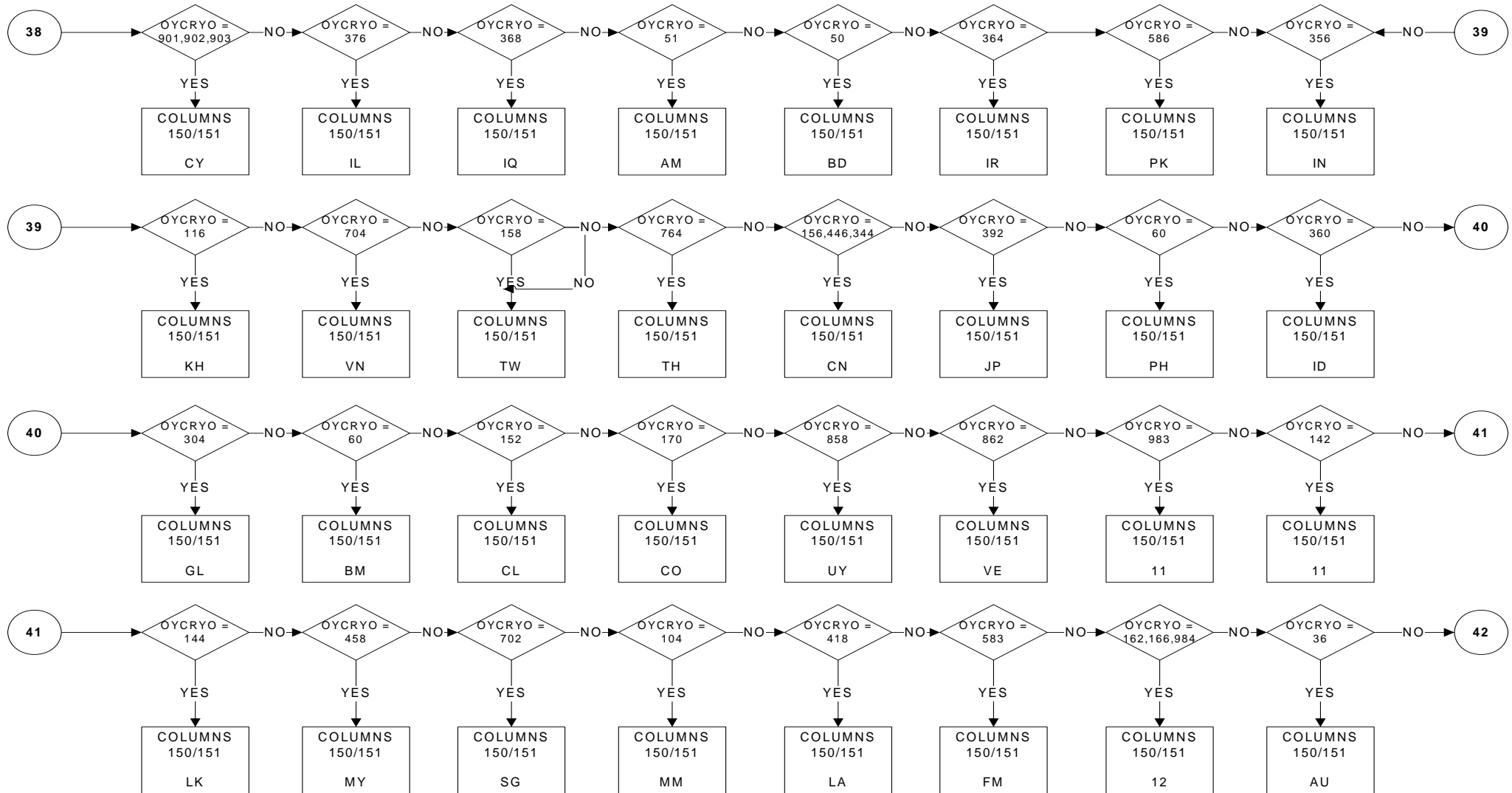

COUNTR1Y (ECTYO): Country of residence one year before survey

Columns 150/151

PAGE 12 OF 15

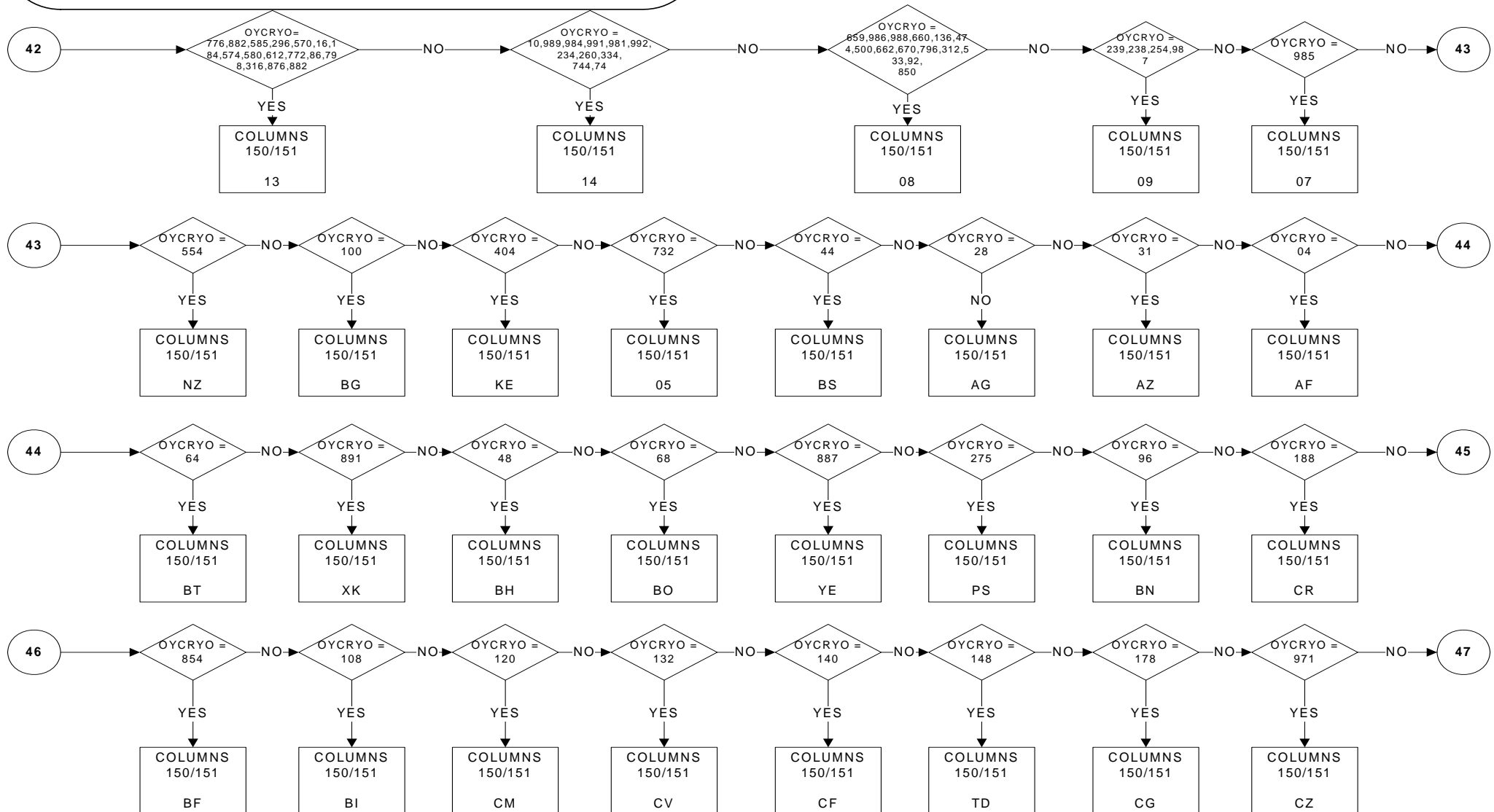

COUNTR1Y (ECTYO): Country of residence one year before survey

Columns 150/151

PAGE 13 OF 15

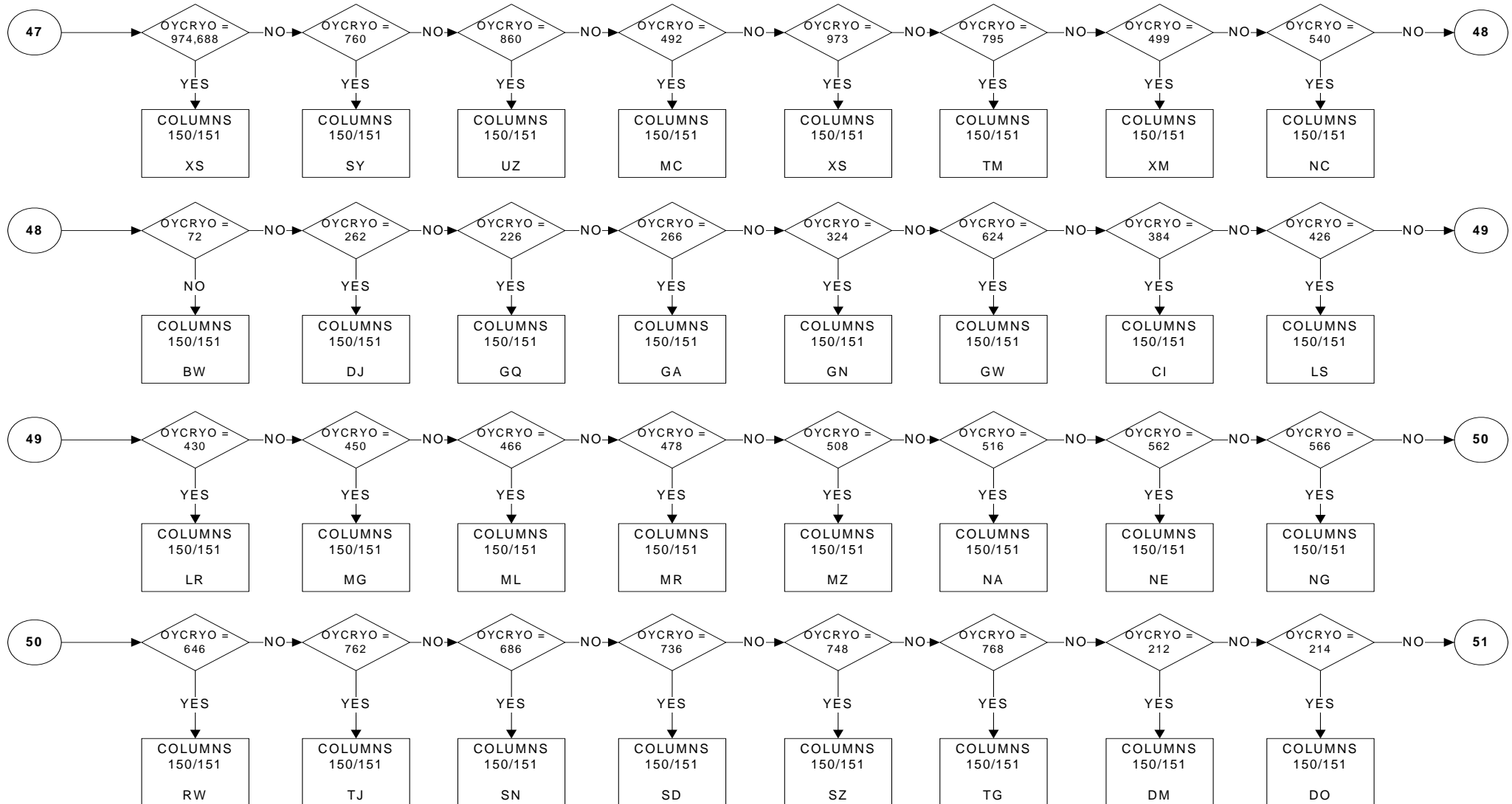

COUNTR1Y (ECTYO): Country of residence one year before survey

Columns 150/151

PAGE 14 OF 15

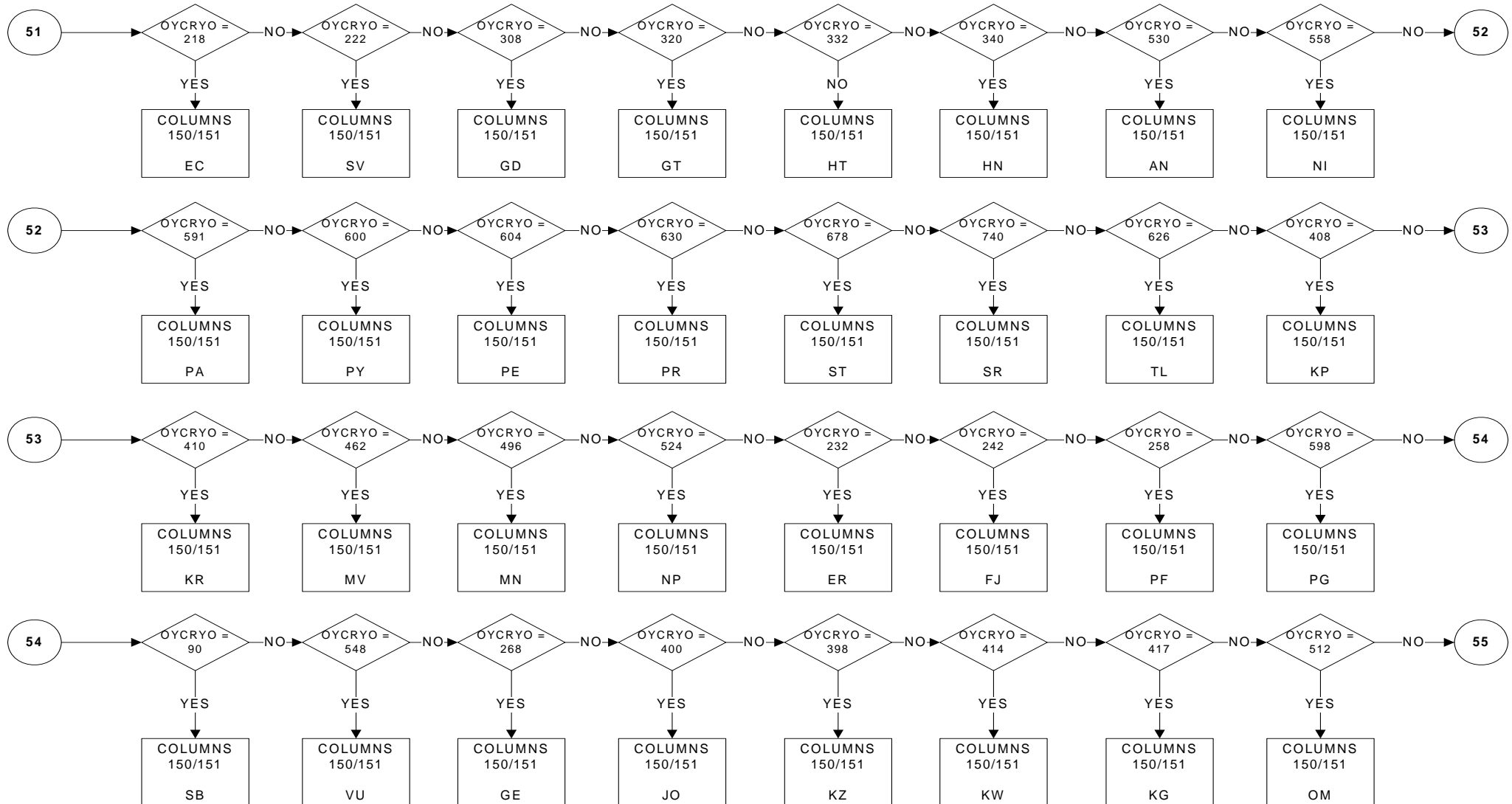

COUNTR1Y (ECTYO): Country of residence one year before survey

Columns 150/151

PAGE 15 OF 15

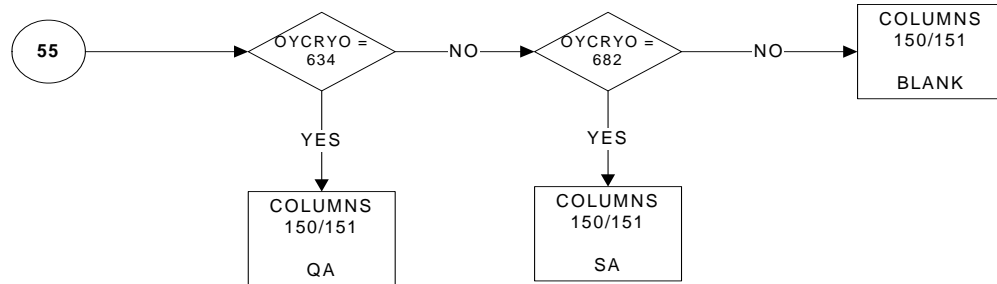

Key

| | |
|-------|---|
| 99 | Not Applicable (child less than one year old) |
| Blank | No Answer |

REGION1Y (EREG00): Region of residence one year before survey

Column 152/153

PAGE 1 OF 1

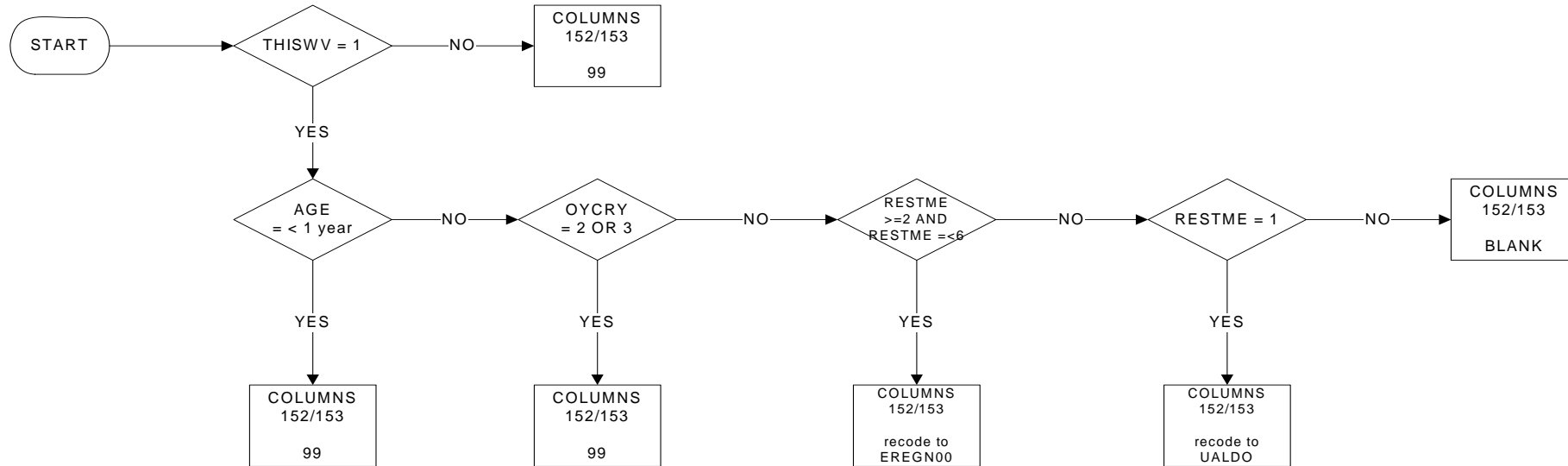

KEY

99 Not applicable (person who has changed country of residence or child less than one year old)
 BLANK No answer

ENETMND: Monthly net (take home) pay from main job

Columns 154/155

PAGE 1 OF 15

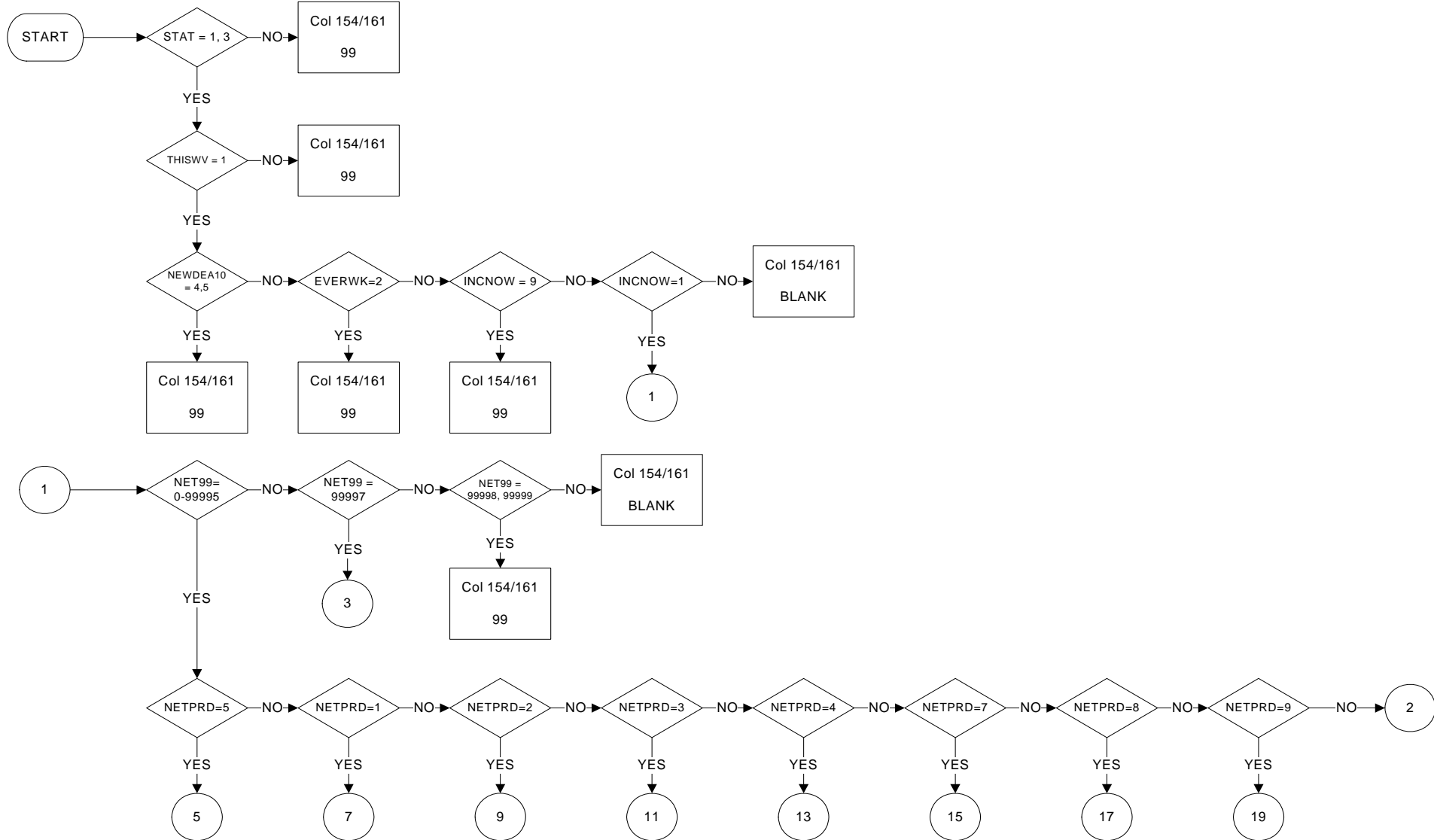

ENTMND: Monthly net (take home) pay from main job

Columns 154/155

PAGE 2 OF 15

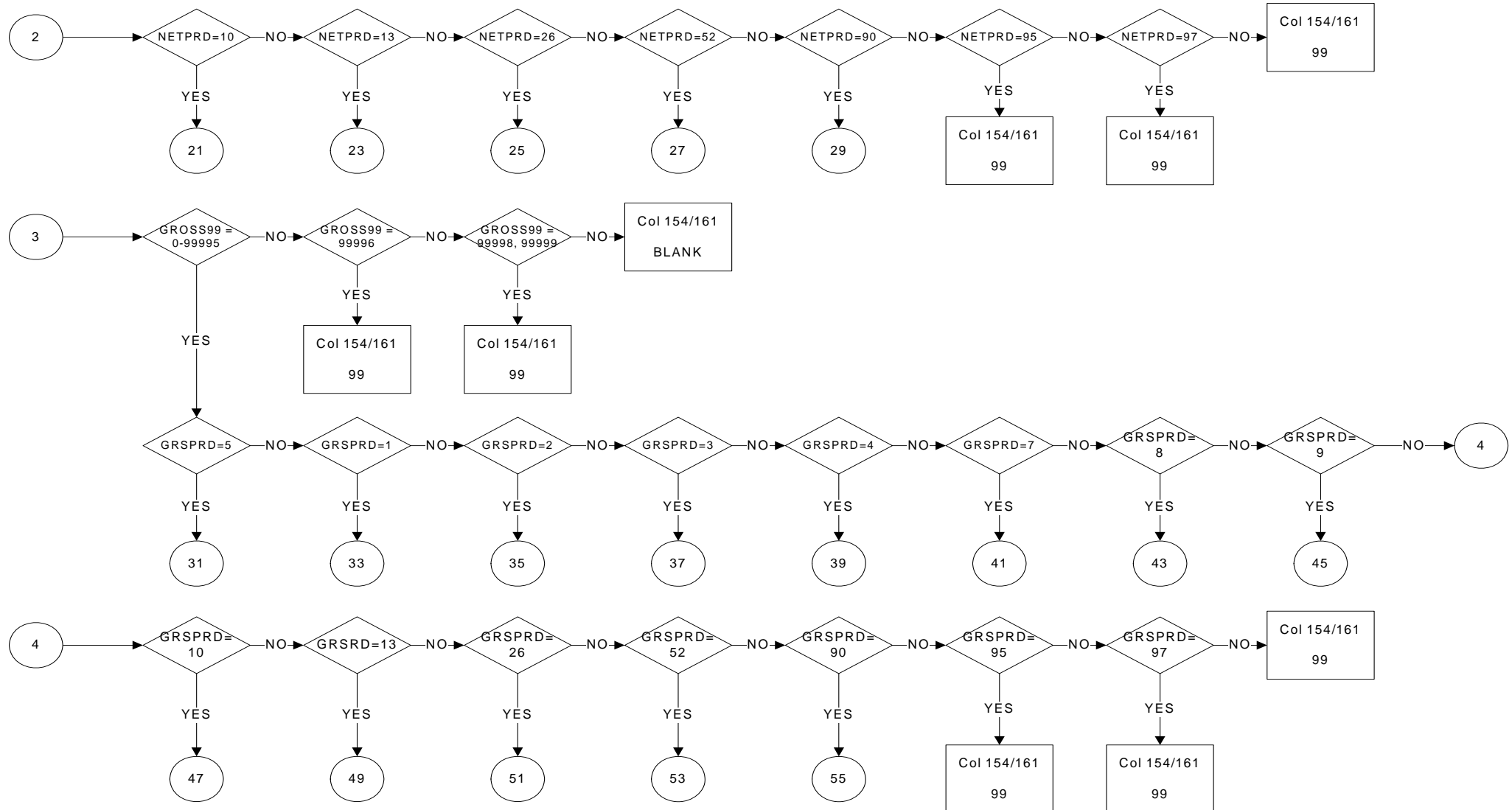

ENTMNDC: Monthly net (take home) pay from main job

Columns 154/155

PAGE 3 OF 15

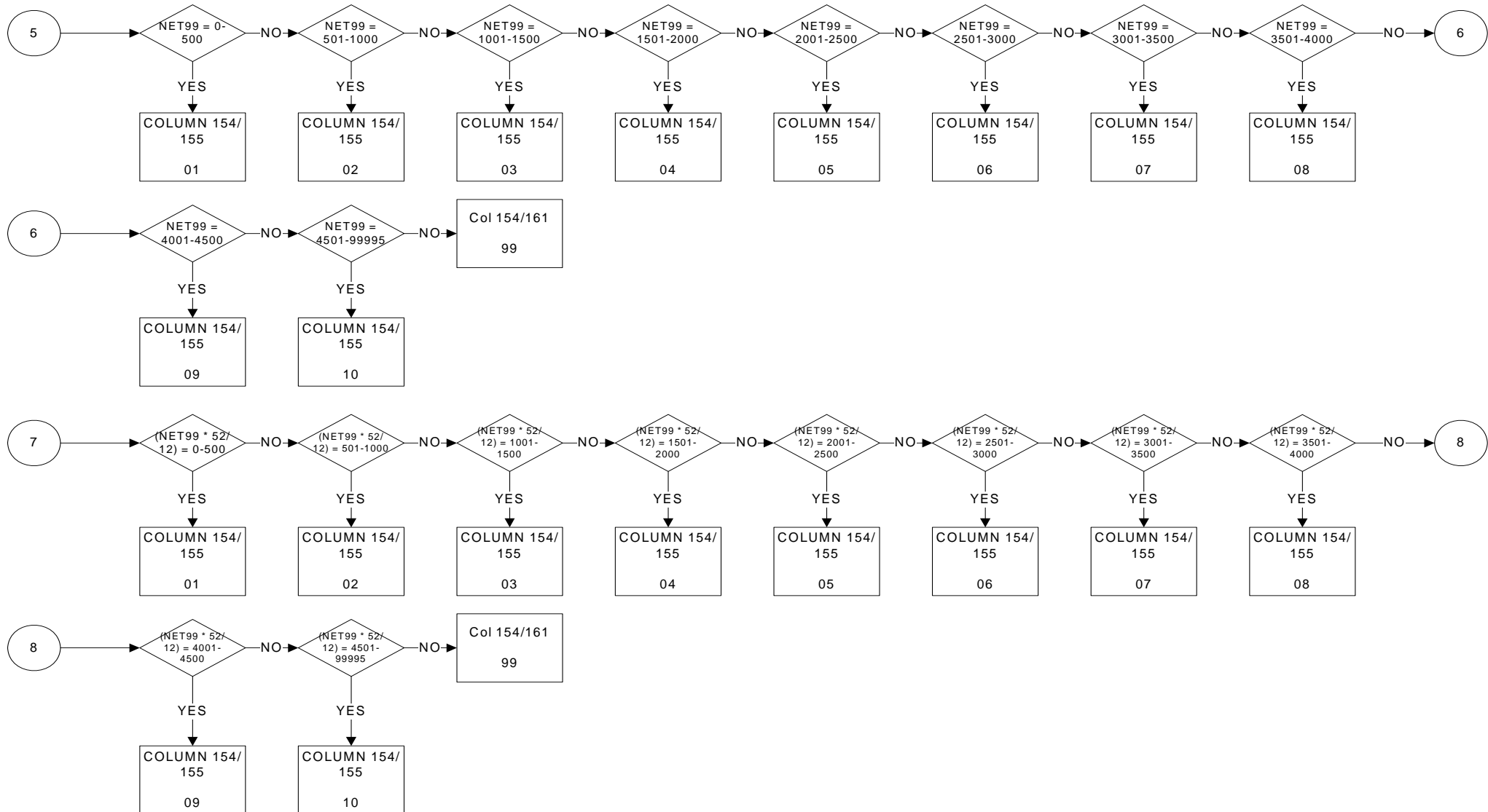

ENTMND: Monthly net (take home) pay from main job

Columns 154/155

PAGE 4 OF 15

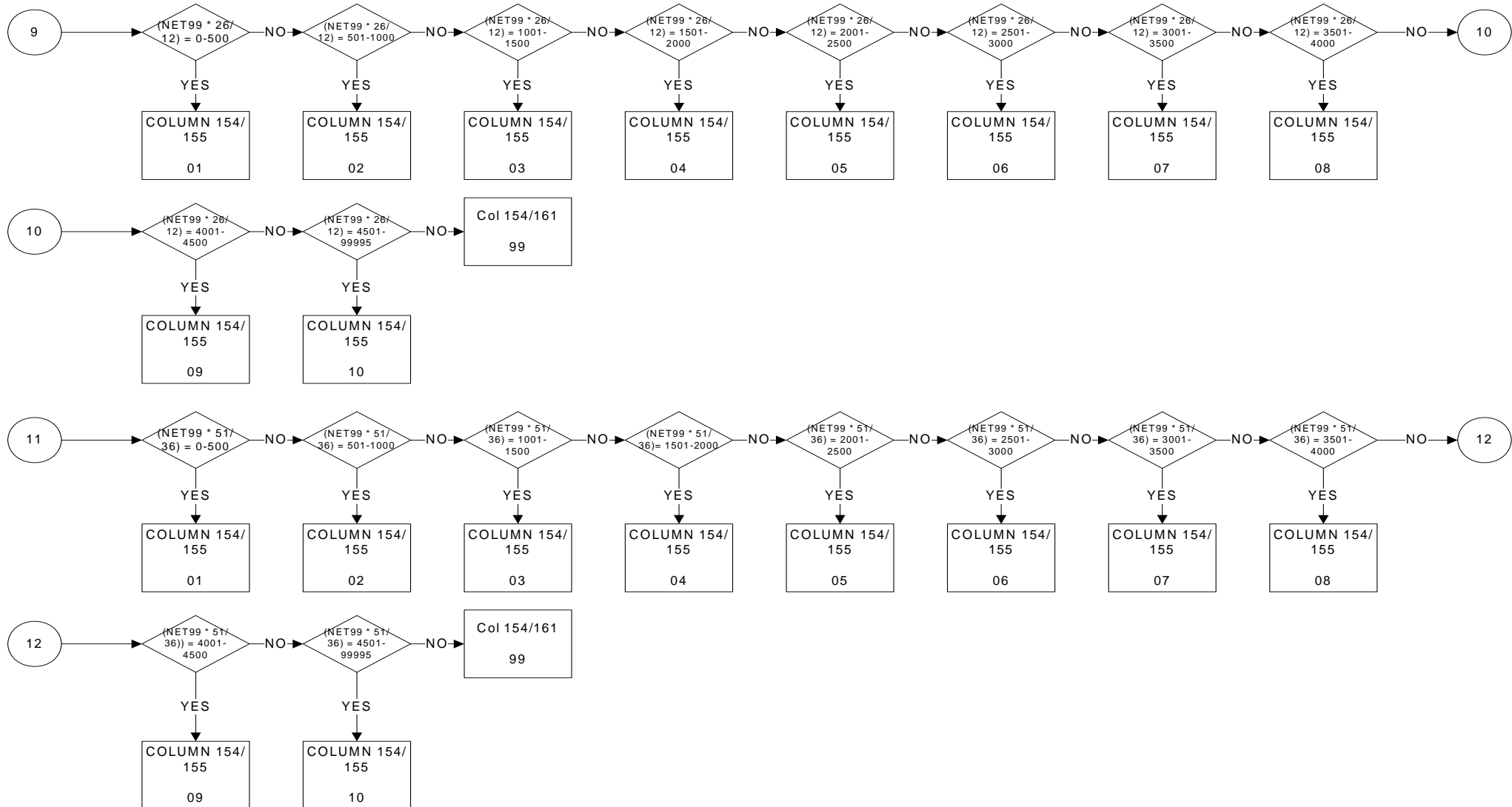

ENTMND: Monthly net (take home) pay from main job
 Columns 154/155
 PAGE 5 OF 15

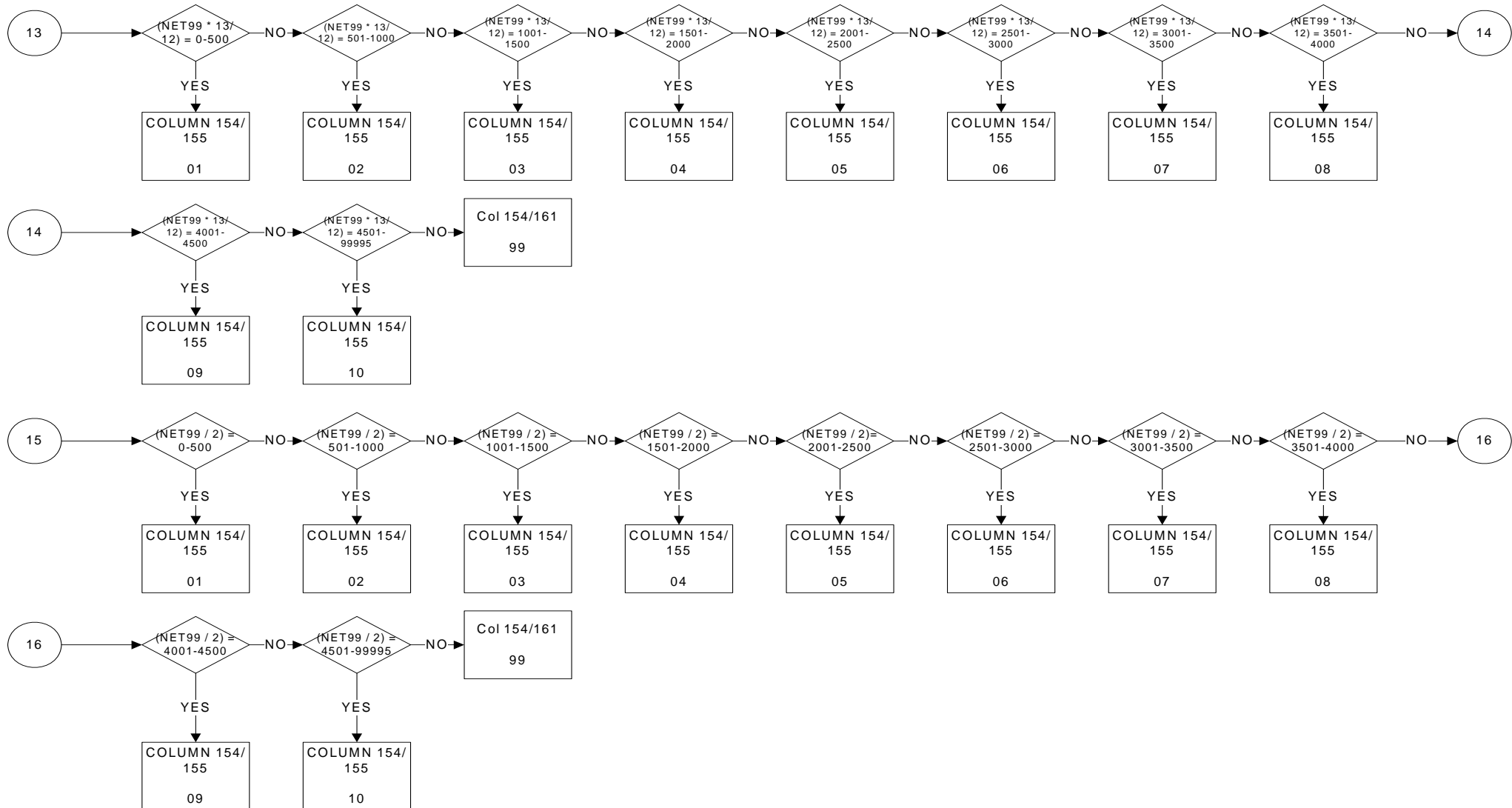

ENTMND: Monthly net (take home) pay from main job

Columns 154/155

PAGE 6 OF 15

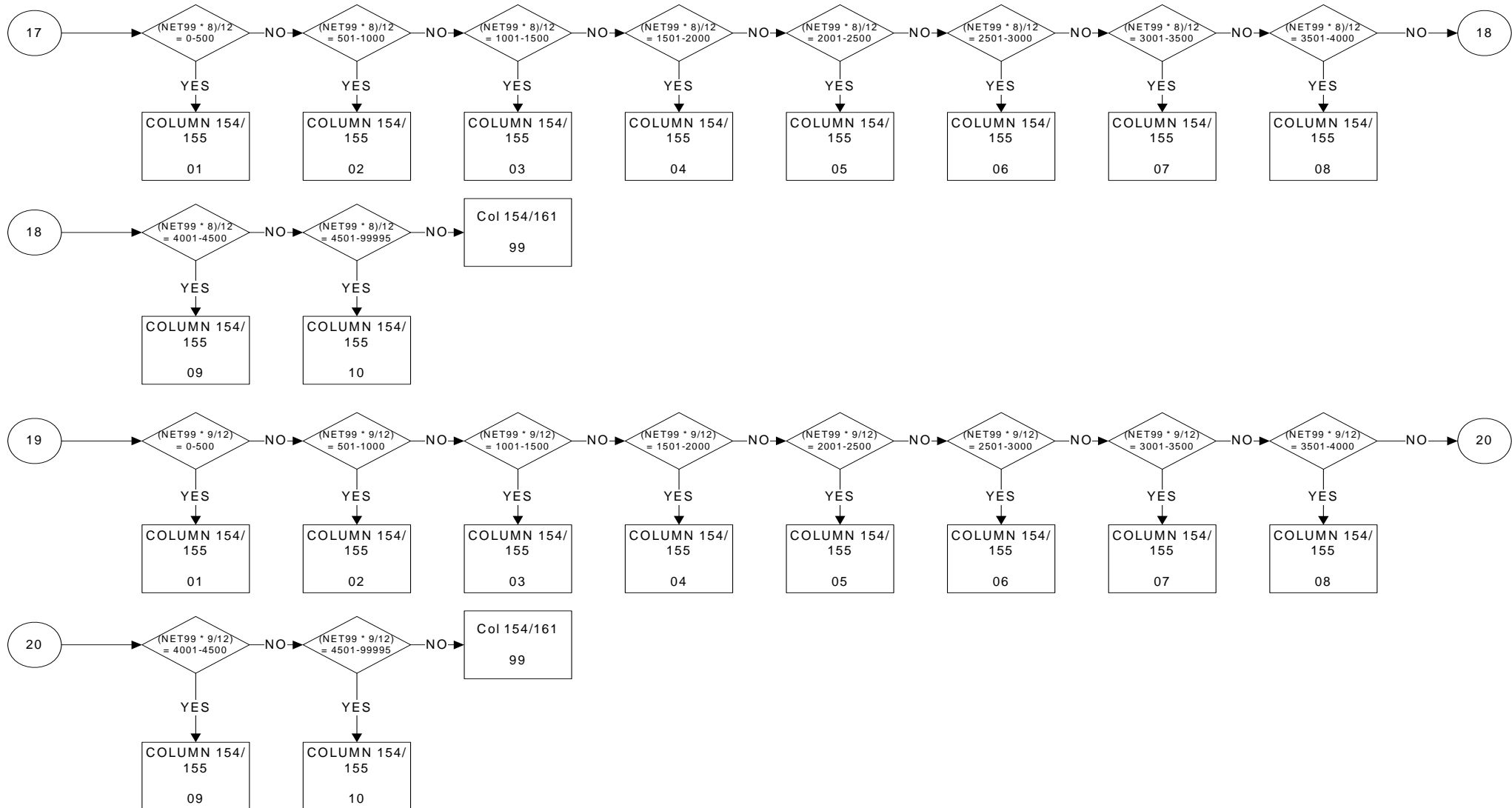

ENTMND: Monthly net (take home) pay from main job

Columns 154/155

PAGE 7 OF 15

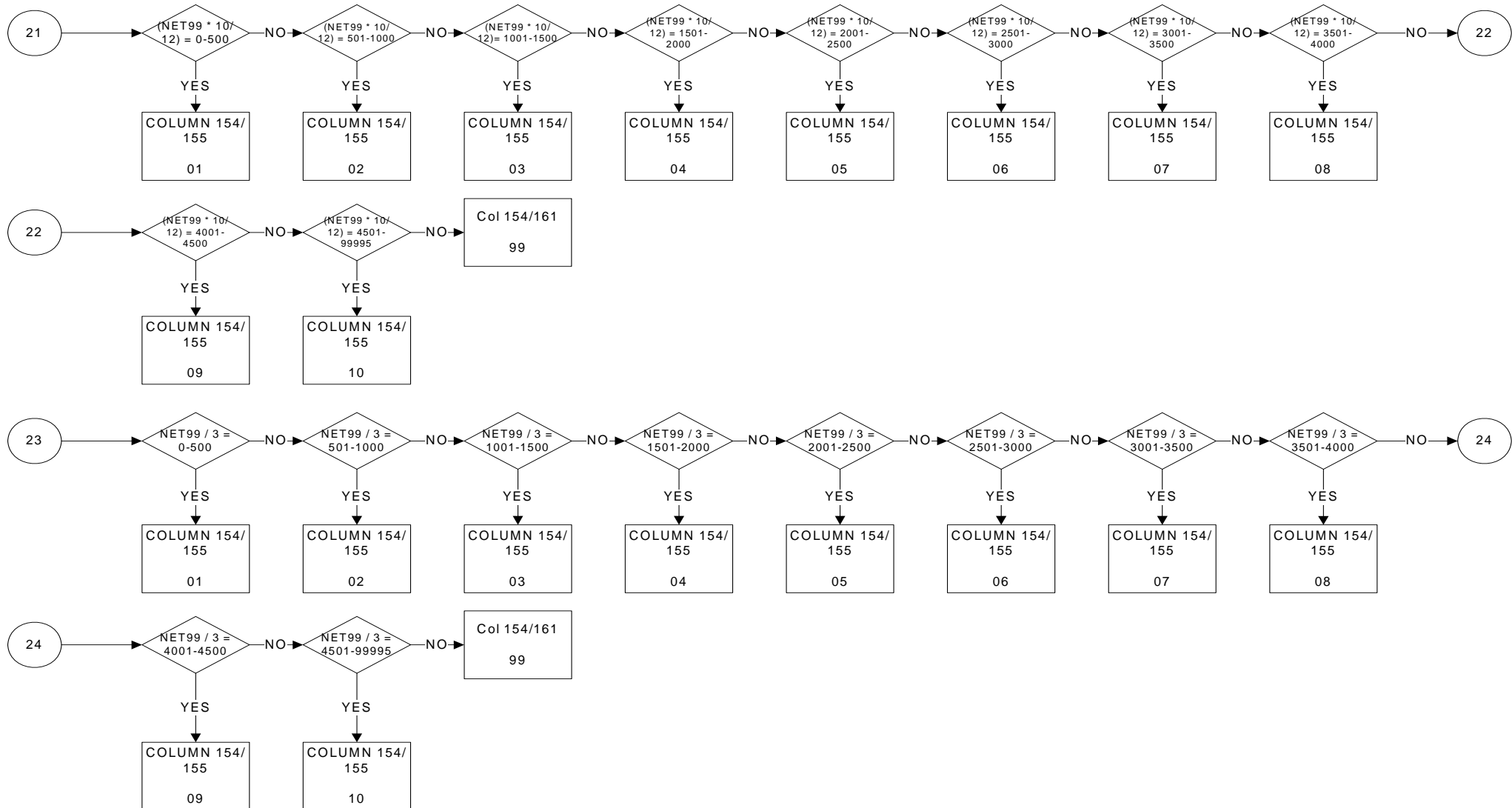

ENTMND: Monthly net (take home) pay from main job

Columns 154/155

PAGE 8 OF 15

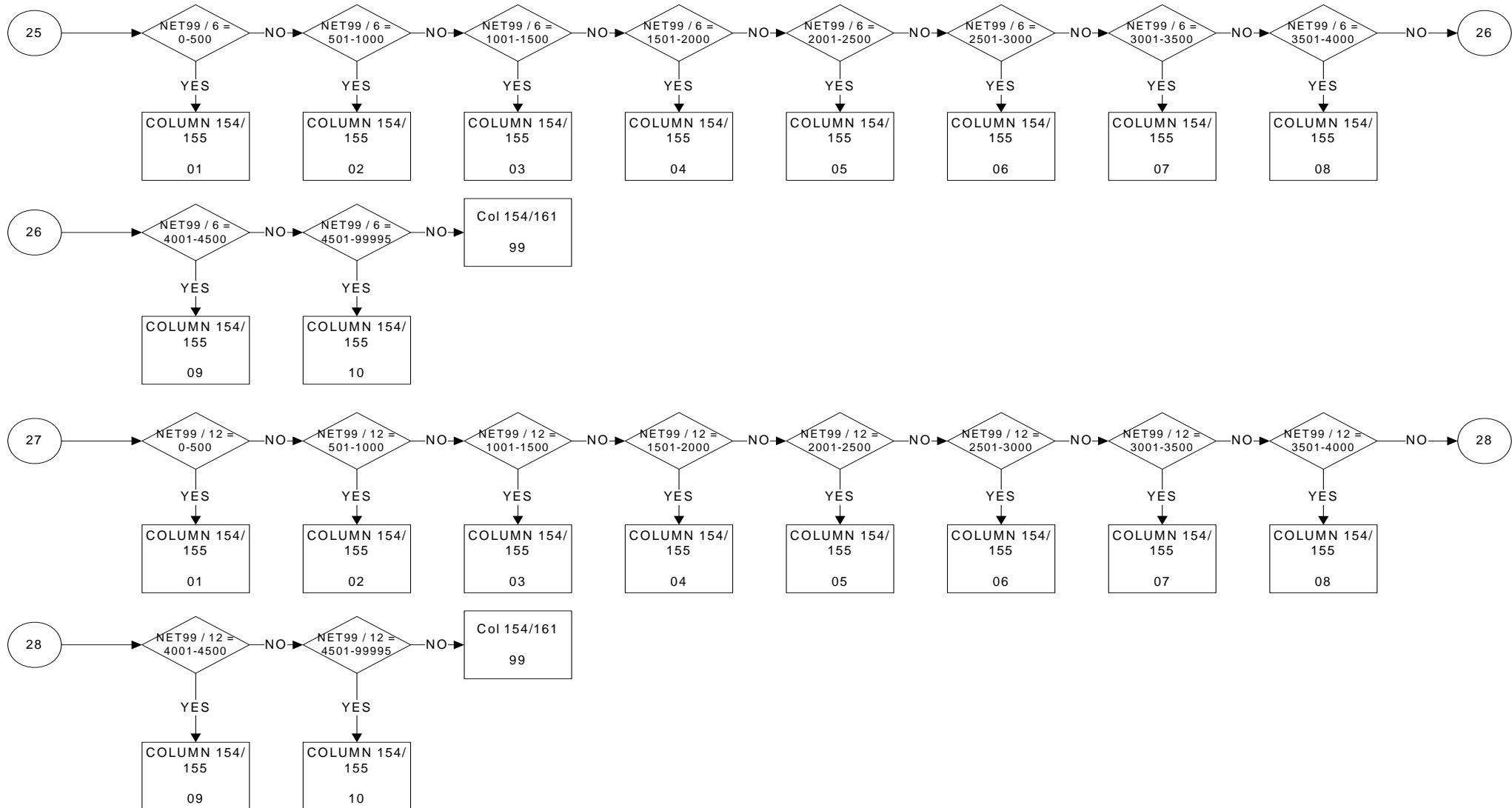

ENTMND: Monthly net (take home) pay from main job

Columns 154/155

PAGE 9 OF 15

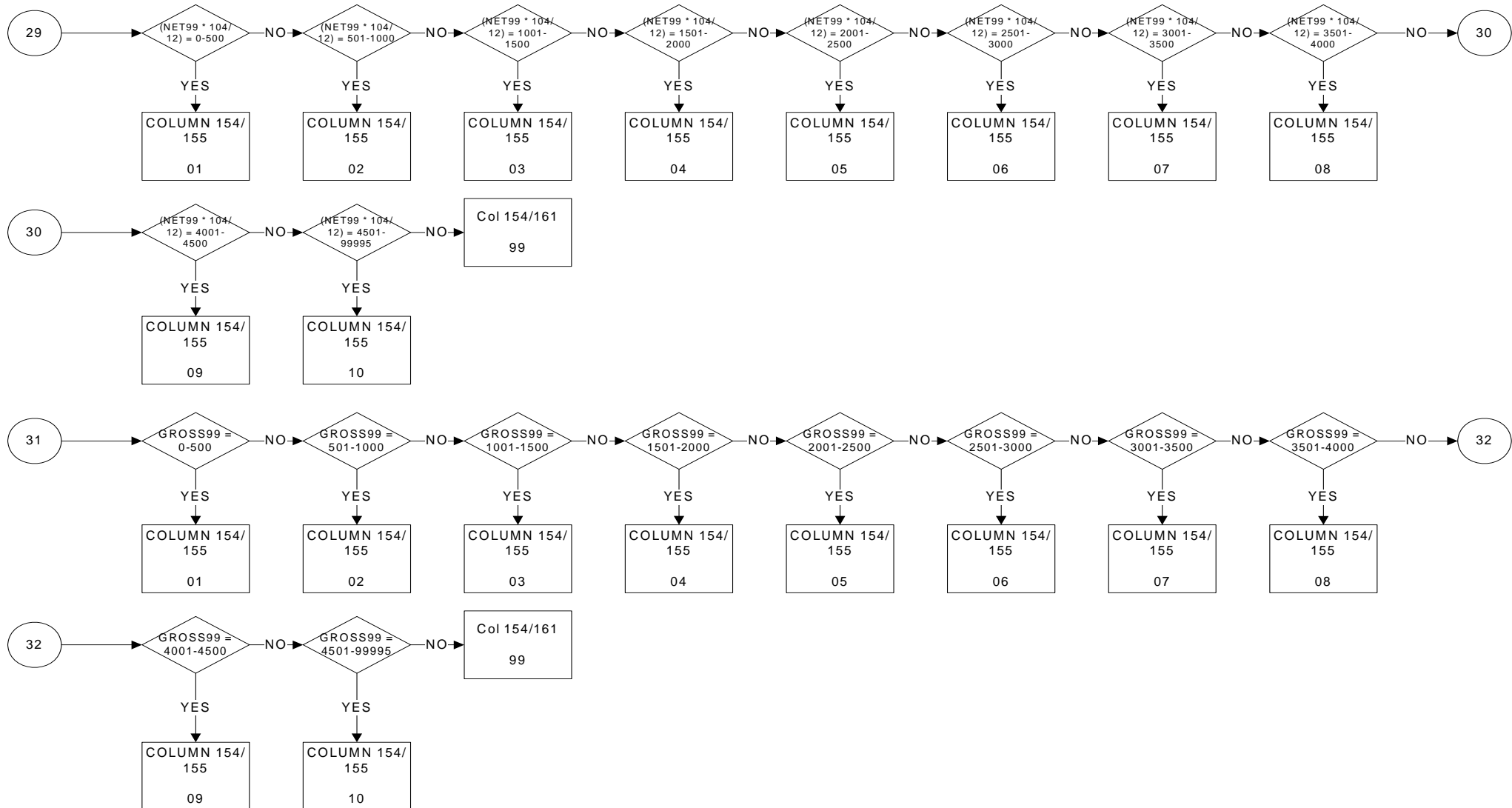

ENTMND: Monthly net (take home) pay from main job

Columns 154/155

PAGE 10 OF 15

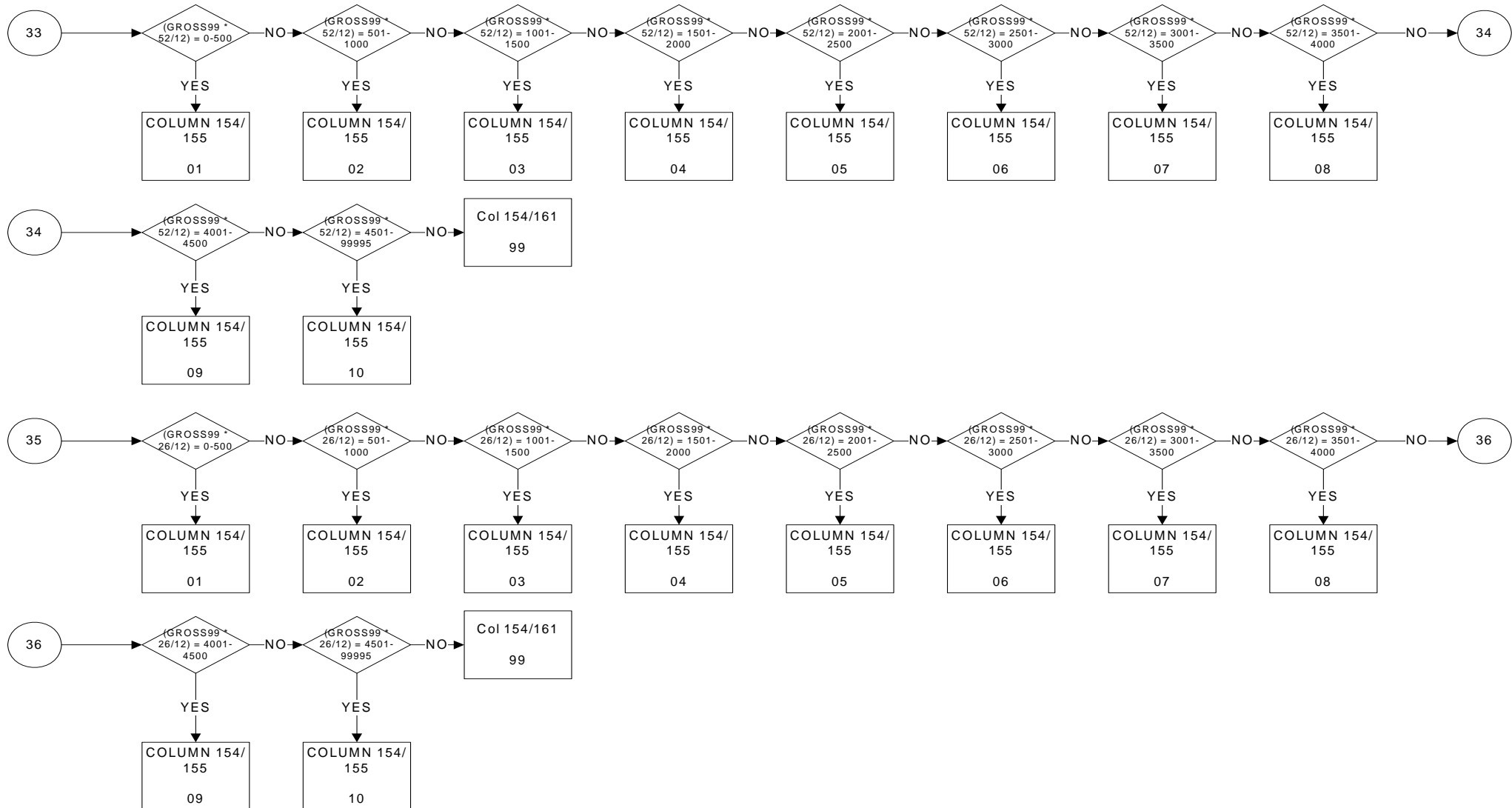

ENTMND: Monthly net (take home) pay from main job

Columns 154/155

PAGE 11 OF 15

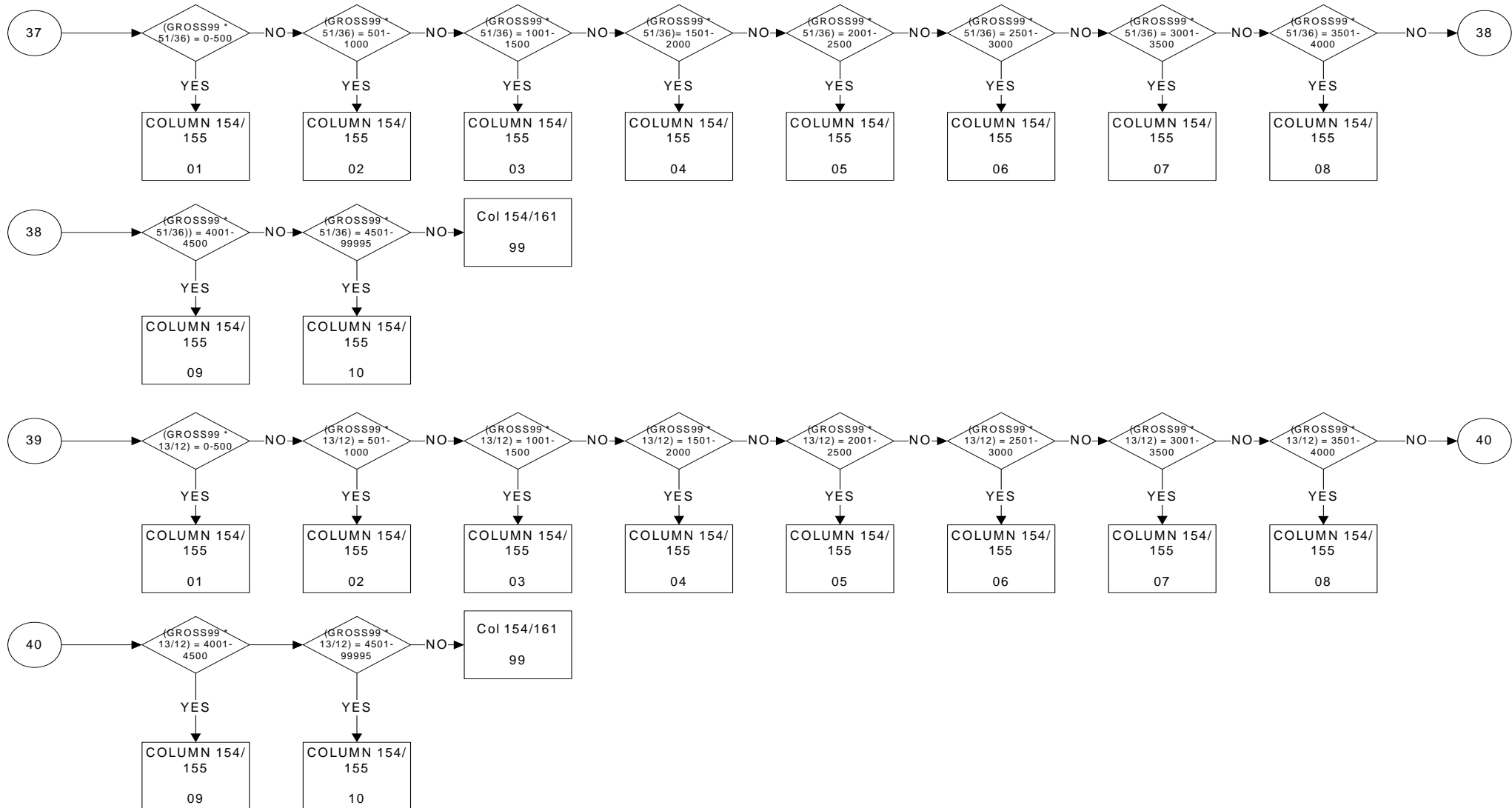

ENTMND: Monthly net (take home) pay from main job

Columns 154/155

PAGE 12 OF 15

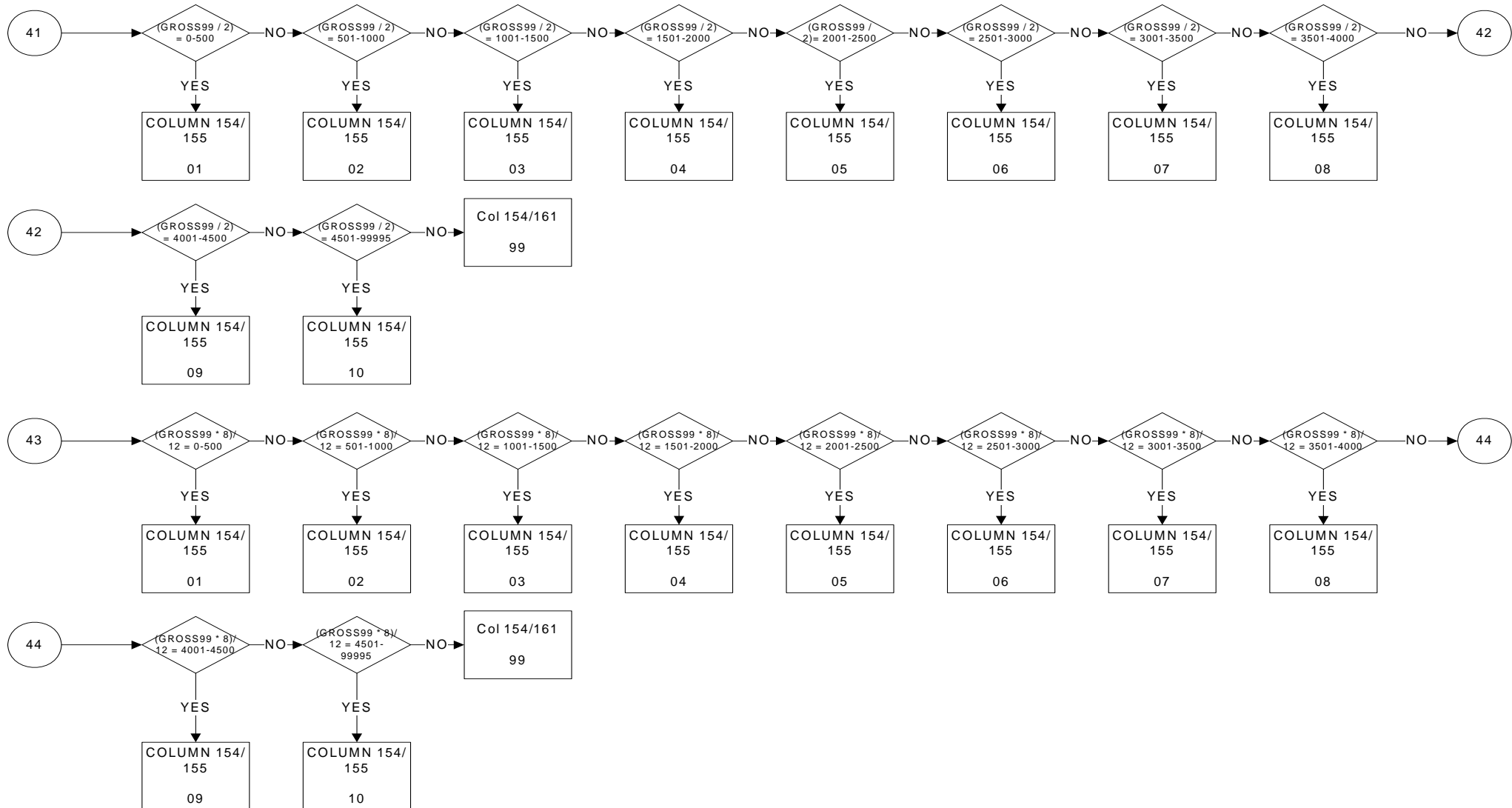

ENTMND: Monthly net (take home) pay from main job

Columns 154/155

PAGE 13 OF 15

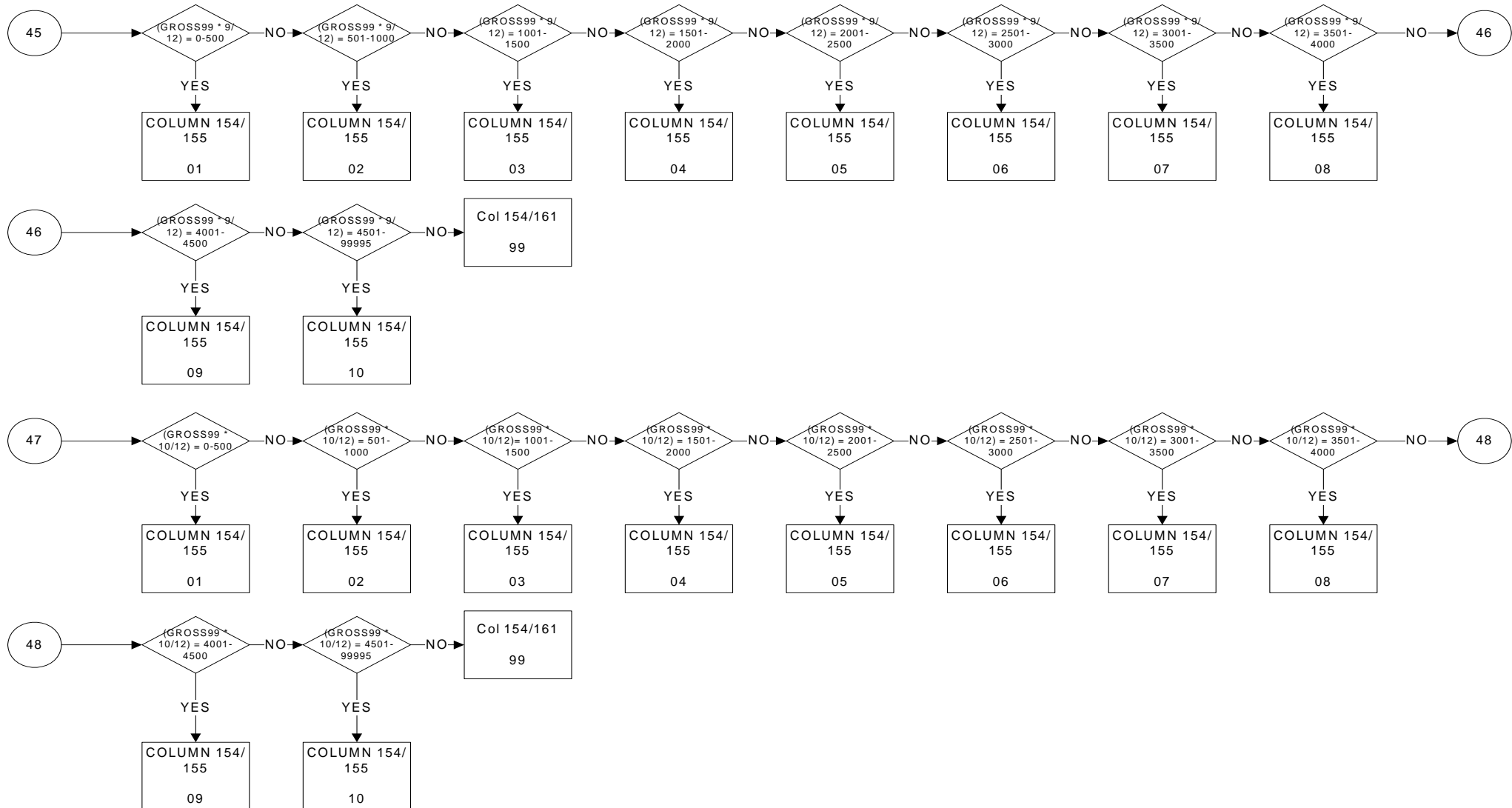

ENTMND: Monthly net (take home) pay from main job

Columns 154/155

PAGE 14 OF 15

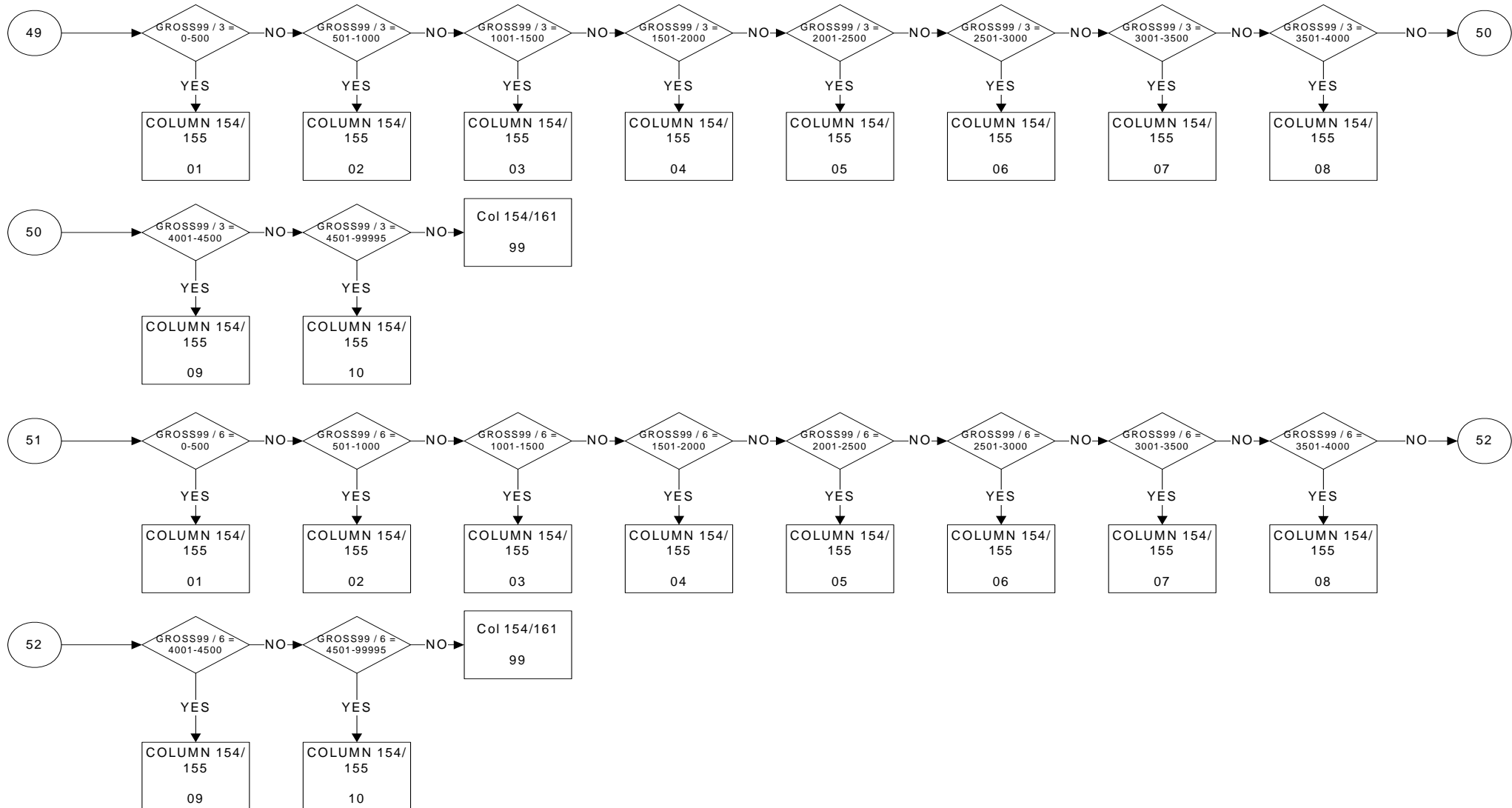

ENTMND: Monthly net (take home) pay from main job

Columns 154/155

PAGE 15 OF 15

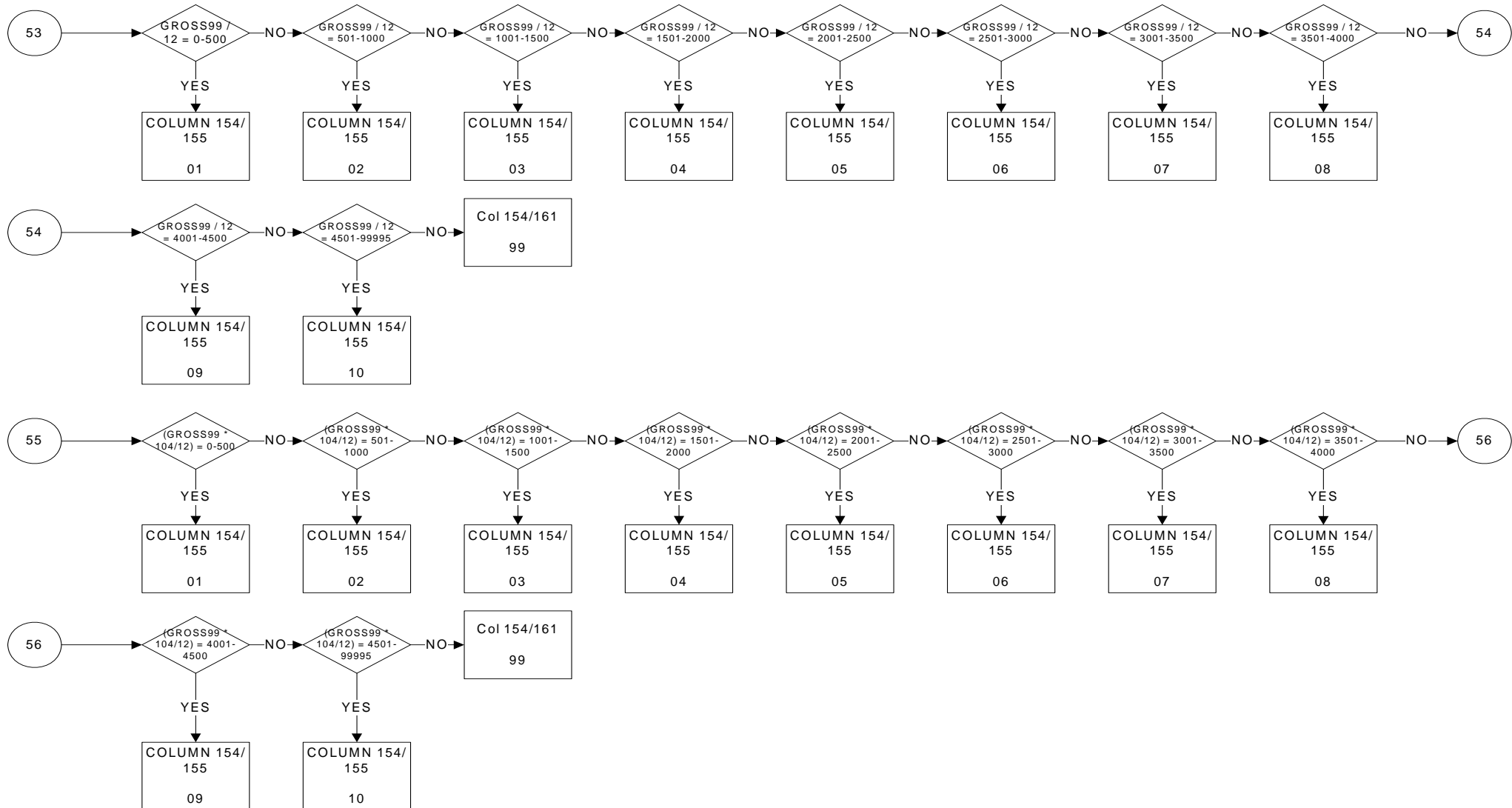

REFYEAR (EYEAR): Year of Survey

Columns 156/159

PAGE 1 OF 1

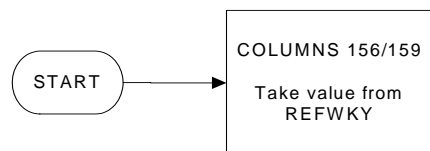

KEY

Year of survey

Last 4 digits of the year

REFWEEK (EREFWK): Reference week
Columns 160/161
PAGE 1 OF 1

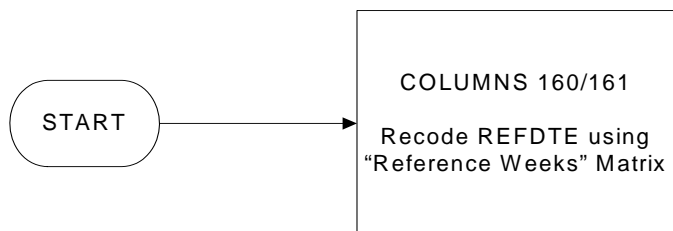

KEY

Number of the week running from Monday to Sunday

INTWEEK (EINTWK): Interview week

Columns 162/163

PAGE 1 OF 1

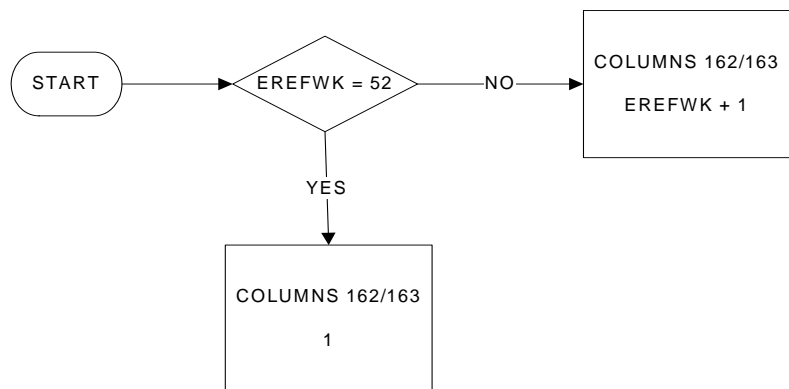

KEY

Number of the week running from Monday to Sunday

COUNTRY (ESTATE): Country

Column 164/165

PAGE 1 OF 1

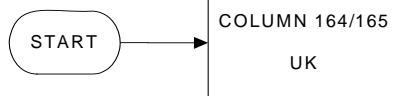

KEY

For coding, see ISO country classification

REGION (EREGN00): Region of household
Column 166/167
PAGE 1 OF 1

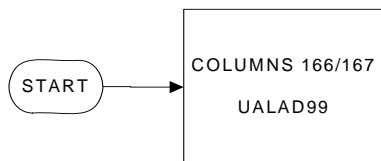

KEY
NUTS 2

DEGURBA (URBAN): Degree of urbanisation

Column 168

PAGE 1 OF 13

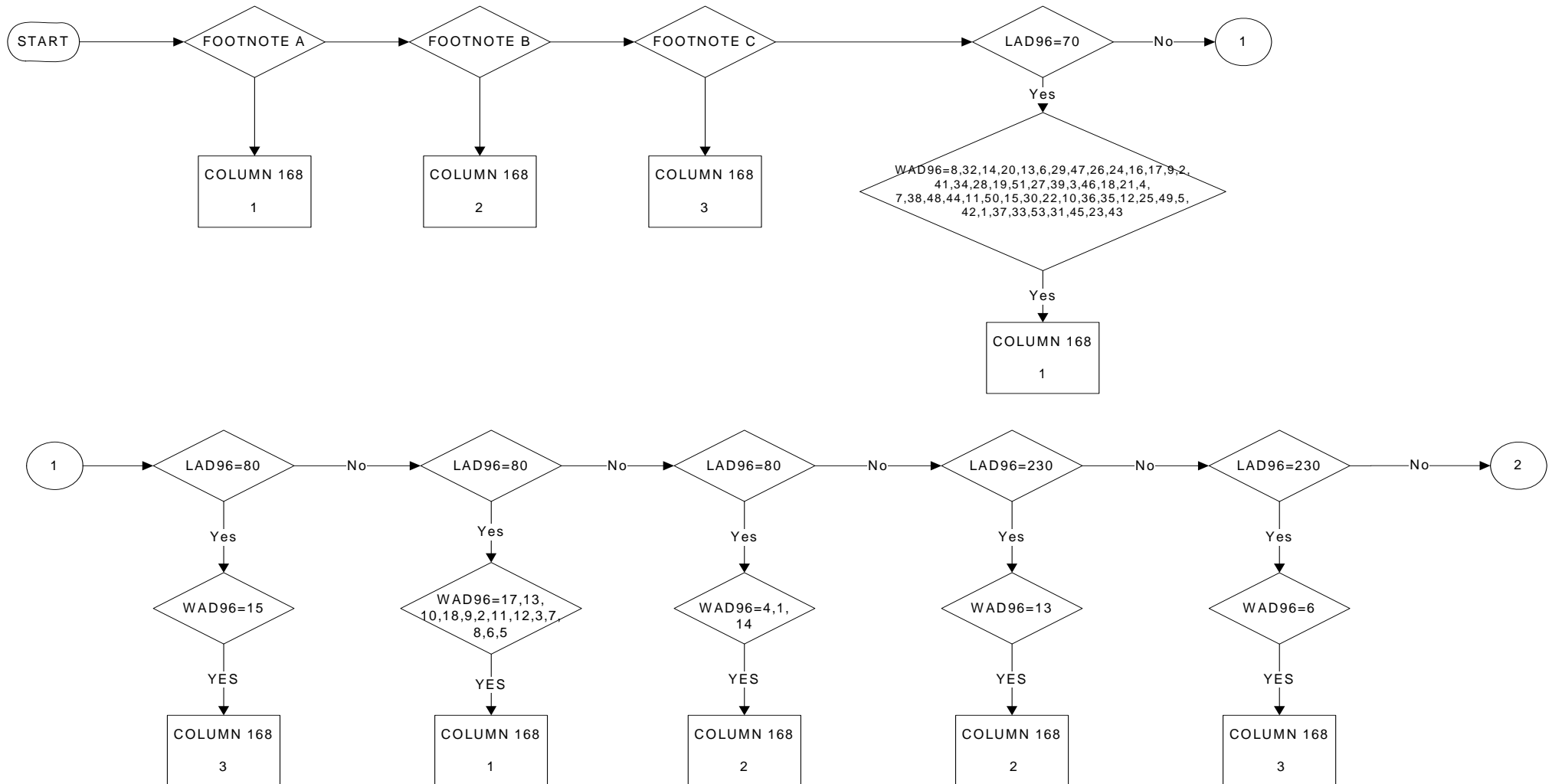

DEGURBA (URBAN): Degree of urbanisation

Column 168

PAGE 2 OF 13

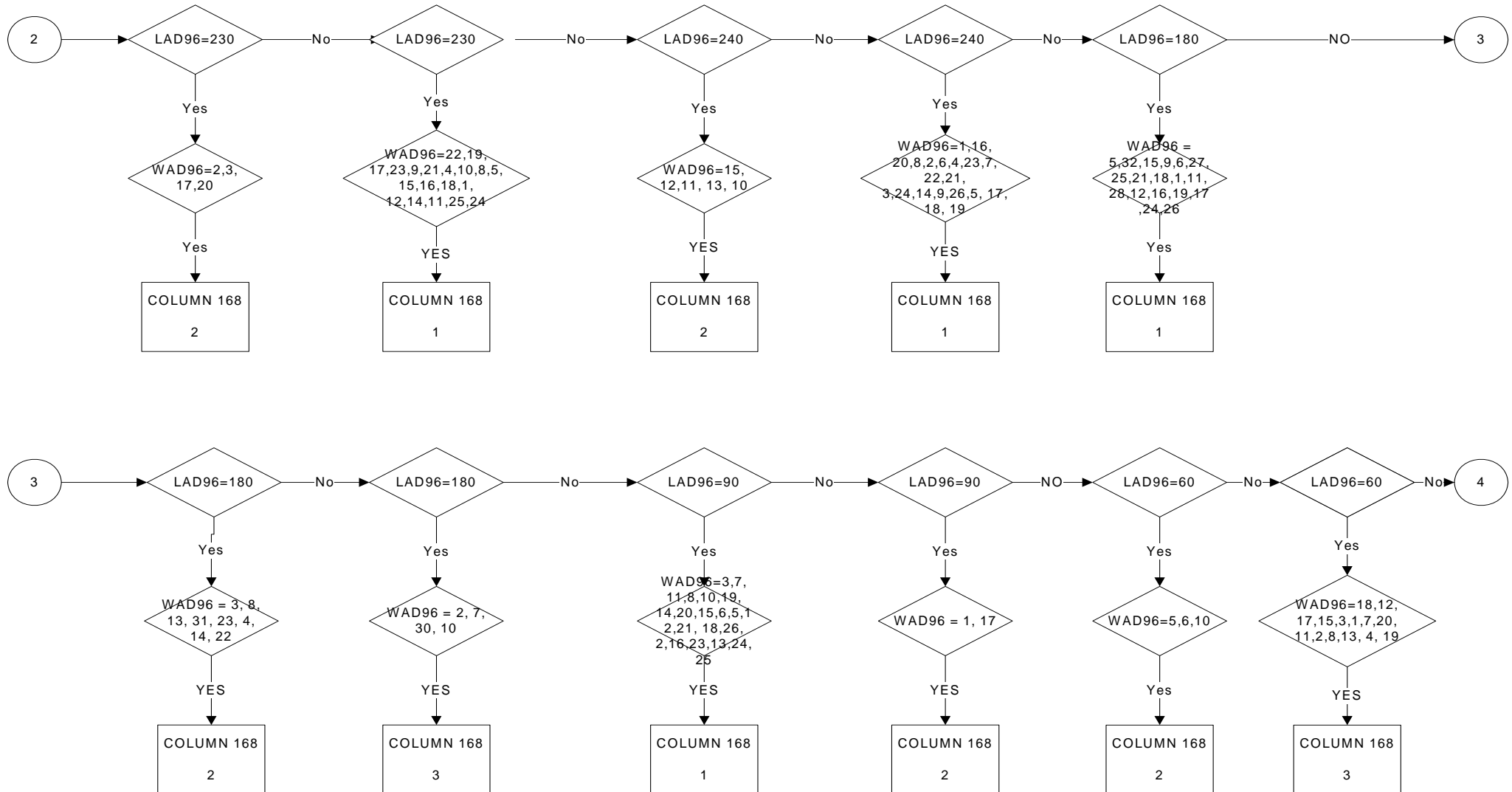

DEGURBA (URBAN): Degree of urbanisation

Column 168

PAGE 3 OF 13

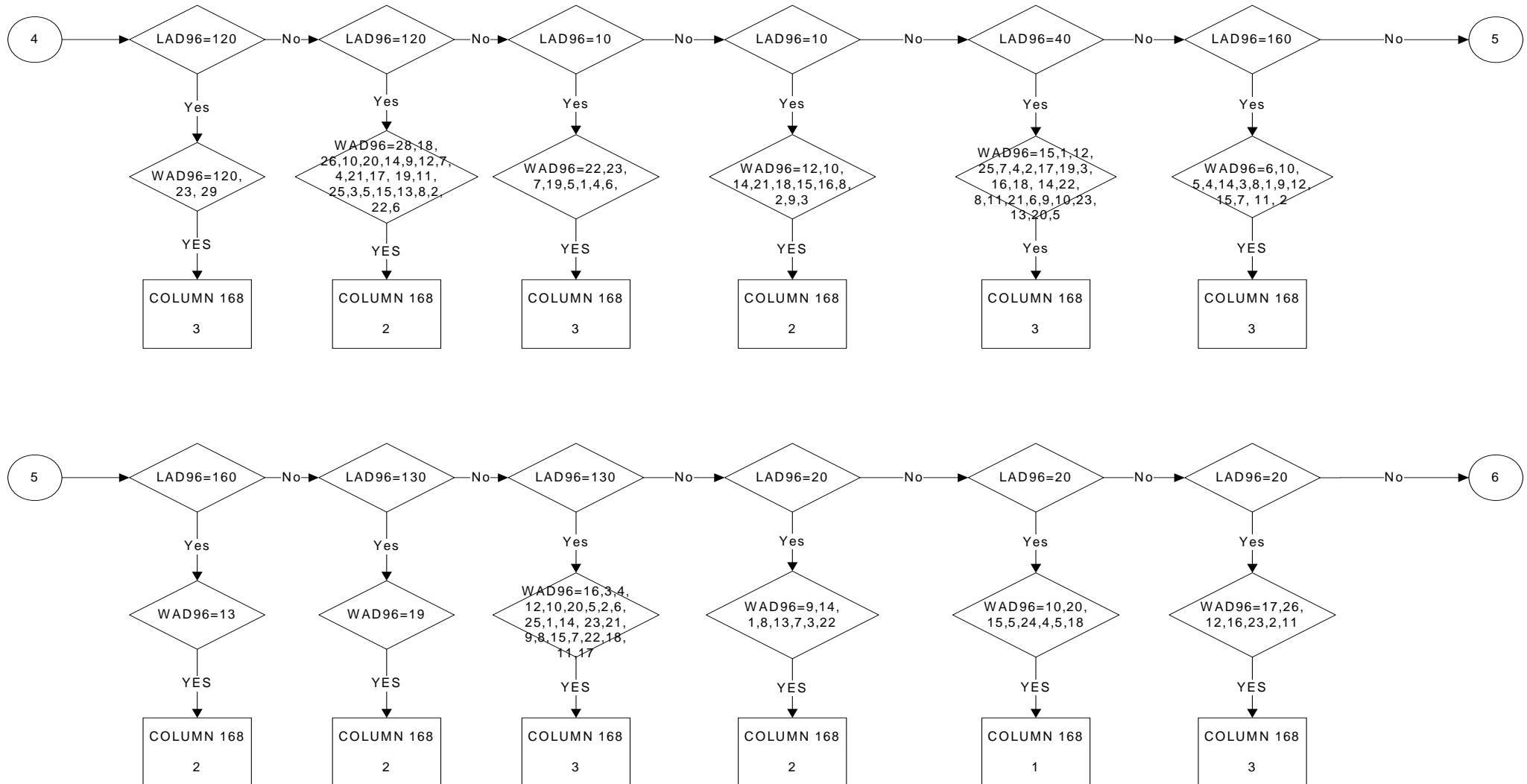

DEGURBA (URBAN): Degree of urbanisation

Column 168

PAGE 4 OF 13

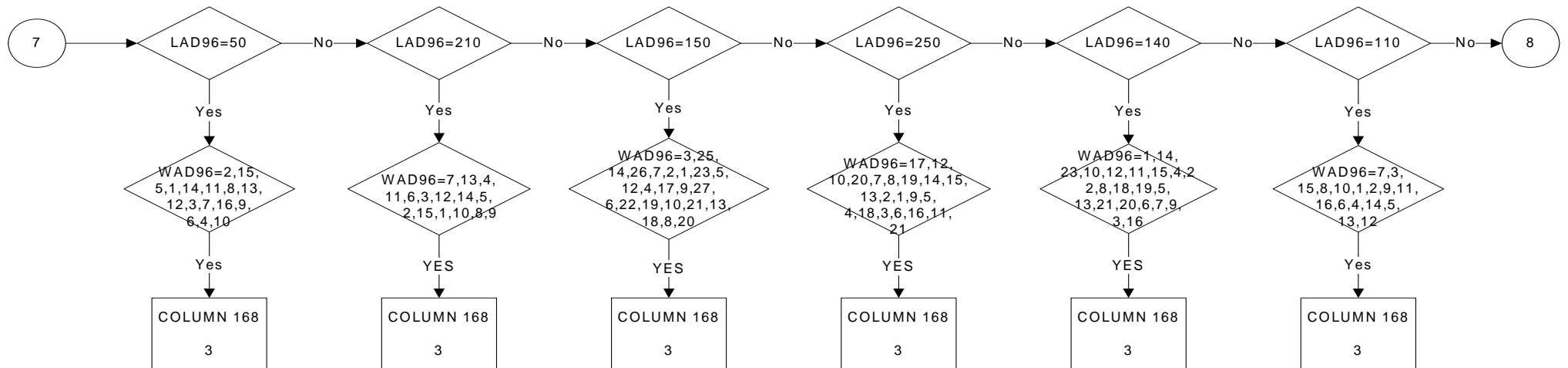
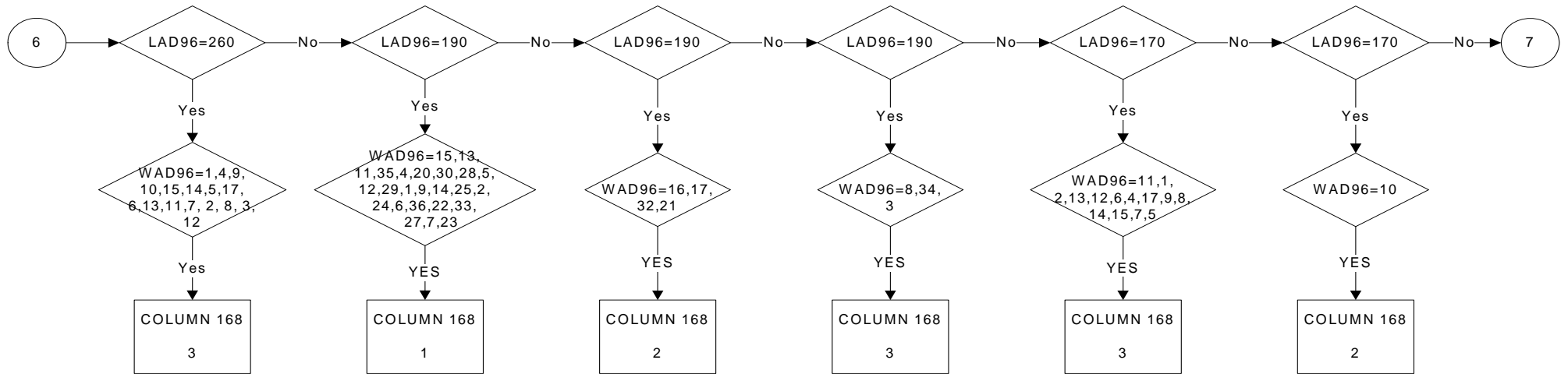

DEGURBA (URBAN): Degree of urbanisation

Column 168

PAGE 5 OF 13

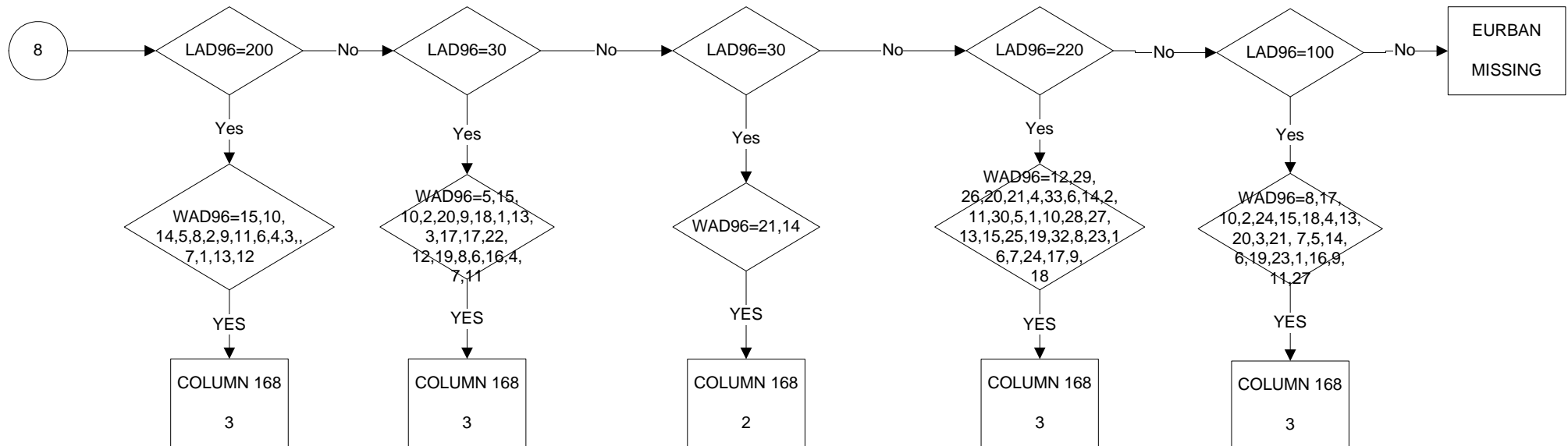

DEGURBA (EURBAN): Degree of urbanisation

Column 168

PAGE 9 OF 13

FOOTNOTE A: CASWARD = 37UEGW, 37UEGX, 37UEGZ, 37UFFU, 37UFFX, 37UFFY, 37UFFZ, 37UFGA, 37UFGB, 37UFGC, 37UFGD, 37UFGE, 37UFGF, 37UFGH, 37UFGJ, 37UFGK, 37UFGM, 37UFGN, 37UFGP, 37UGHD, 37UJGG, 37UJGH, 37UJGJ, 37UJGK, 37UJGN, 37UJGP, 37UJGT, 37UJGW, 37UJGX, 37UJGY, 37UJGZ, 37UJHC, 37UJHJ, 38UCFT, 38UCFU, 38UCFW, 38UCFX, 38UCFY, 38UCFZ, 38UCGA, 38UCGB, 38UCGC, 38UCGD, 38UCGE, 38UCGF, 38UCGG, 38UCGH, 38UCGJ, 38UCGK, 38UCGL, 38UCGM, 38UCGN, 38UCGP, 38UCGQ, 38UCGR, 38UCGS, 38UCGT, 38UDHP, 38UEHC, 39UBGP, 39UEFX, 39UEGA, 39UEGB, 39UEGC, 39UEGD, 39UEGE, 39UEGF, 39UEGH, 39UEGK, 39UEGN, 39UEGP, 39UEGS, 39UEGX, 39UEGY, 39UEGZ, 40UEGH, 40UEGM, 40UEGX, 40UEGY, 40UEGZ, 40UEHA, 40UEHB, 40UEHC, 40UEHD, 40UEHE, 41UBFS, 41UBFT, 41UBFU, 41UBFW, 41UBFZ, 41UBGA, 41UBGB, 41UBGC, 41UBGD, 41UBGF, 41UCGD, 41UCGF, 41UCGG, 41UCGL, 41UCGN, 41UCGR, 41UCGS, 41UCGT, 41UCGY, 41UDGE, 41UDGH, 41UDGJ, 41UDGL, 41UDGM, 41UDGN, 41UDGP, 41UDGR, 41UDGS, 41UDGU, 41UDGX, 41UDHB, 41UDHE, 41UDHF, 41UEGB, 41UEGC, 41UEGD, 41UEGE, 41UEGF, 41UEGH, 41UEGK, 41UEGL, 41UEGP, 41UEGQ, 41UEGR, 41UEGS, 41UEGT, 41UEGU, 41UEGW, 41UEGX, 41UEGY, 41UEGZ, 41UEHA, 41UFHM, 41UFHQ, 41UFHR, 41UFHS, 41UFHU, 41UFHW, 41UFHX, 41UFJG, 41UFJH, 41UGGJ, 41UGGM, 41UGGN, 41UGGQ, 41UGGU, 41UGGW, 41UGGX, 41UGGY, 41UGHB, 41UGHC, 41UGHH, 41UGHK, 41UHGH, 41UHGG, 41UHGM, 41UHGN, 41UHGQ, 41UHGZ, 41UHHJ, 41UKFL, 41UKFM, 41UKFN, 41UKFP, 41UKFQ, 41UKFR, 41UKFS, 41UKFT, 41UKFU, 41UKFW, 42UBHF, 42UDFS, 42UDFT, 42UDFU, 42UDFW, 42UDFX, 42UDFY, 42UDFZ, 42UDGA, 42UDGB, 42UDGC, 42UDGD, 42UDGE, 42UDGF, 42UDGG, 42UDGH, 42UDGJ, 42UGHJ, 42UGHK, 42UGHX, 42UHGC, 42UHGD, 42UHGE, 42UHGG, 42UHGJ, 42UHGL, 42UHGM, 42UHGN, 42UHGP, 42UHGQ, 42UHGU, 43UBFZ, 43UBGA, 43UBGB, 43UBGC, 43UBGD, 43UBGE, 43UBGF, 43UBGG, 43UBGH, 43UBGJ, 43UBGK, 43UBGL, 43UBGM, 43UBGN, 43UBGP, 43UBGQ, 43UBGR, 43UBGS, 43UBGT, 43UBGU, 43UBGW, 43UBGX, 43UCFP, 43UCFQ, 43UCFR, 43UCFS, 43UCFT, 43UCFU, 43UCFW, 43UCFX, 43UCFY, 43UCFZ, 43UCGA, 43UCGB, 43UCGC, 43UDFY, 43UDFZ, 43UDGA, 43UDGB, 43UDGC, 43UDGF, 43UDGG, 43UDGJ, 43UDGL, 43UDGP, 43UDGR, 43UDGS, 43UDGU, 43UEGA, 43UEGB, 43UEGC, 43UEGE, 43UEGF, 43UEGN, 43UEGP, 43UEGR, 43UEGS, 43UFFU, 43UFFX, 43UFFY, 43UFFZ, 43UFGA, 43UFGC, 43UFGD, 43UFGG, 43UFGH, 43UFGJ, 43UFGK, 43UFGM, 43UFGN, 43UFGP, 43UGFQ, 43UGFR, 43UGFS, 43UGFT, 43UGFU, 43UGFW, 43UGFX, 43UGFY, 43UGFZ, 43UGGB, 43UGGC, 43UGGE, 43UHFS, 43UHFT, 43UHFU, 43UHFV, 43UHFZ, 43UHGA, 43UHGB, 43UHGC, 43UHGD, 43UHGE, 43UHGF, 43UJFS, 43UJFT, 43UJFW, 43UJFX, 43UJFY, 43UJFZ, 43UJGA, 43UJGB, 43UJGC, 43UJGD, 43UJGE, 43UJGF, 43UJGG, 43UKGE, 43UKGK, 43UKGL, 43UKGN, 43UKGQ, 43UKGR, 43UKGS, 43ULGP, 43ULGQ, 43ULGR, 43ULGS, 43ULGT, 43ULGU, 43ULGW, 43ULGX, 43ULGY, 43UMFT, 43UMFU, 43UMFW, 43UMFX, 43UMFY, 43UMFZ, 43UMGA, 43UMGB, 43UMGC, 43UMGE, 43UMGF, 43UMGG, 43UMGH, 43UMGJ, 43UMGK, 44UBGJ, 44UBGL, 44UBGM, 44UBGN, 44UCFR, 44UCFT, 44UCFU, 44UCFW, 44UCFY, 44UCFZ, 44UCGA, 44UCGB, 44UCGC, 44UCGD, 44UCGE, 44UCGF, 44UCGG, 44UCGH, 44UCGJ, 44UDFZ, 44UDGB, 44UDGC, 44UDGD, 44UDGE, 44UDGF, 44UDGJ, 44UDGL, 44UDGP, 44UDGQ, 44UDGR, 44UDGS, 44UEHQ, 44UFFZ, 44UFGB, 44UFGC, 44UFGG, 44UFGH, 44UFGN, 44UFGP, 44UFGQ, 44UFGR, 44UFGS, 45UBFQ, 45UBFR, 45UBFS, 45UBFT, 45UBFU, 45UBFW, 45UBFX, 45UBFY, 45UBFZ, 45UBGA, 45UBGB, 45UBGC, 45UBGD, 45UBGE, 45UCGE, 45UCGF, 45UCGK, 45UCGL, 45UCGM, 45UCGN, 45UCGP, 45UCGQ, 45UCGR, 45UCGT, 45UCGU, 45UCGW, 45UCGX, 45UCGY, 45UCGZ, 45UCHA, 45UCHB, 45UCHC, 45UCHD, 45UCHF, 45UDHM, 45UEFP, 45UEFQ, 45UEFR, 45UEFS, 45UEFT, 45UEFU, 45UEFW, 45UEFX, 45UEFY, 45UEFZ, 45UEGA, 45UEGB, 45UEGC, 45UEGD, 45UEGE, 45UEGF, 45UEGJ, 45UEGK, 45UEGM, 45UEGN, 45UEGP, 45UEGT, 45UEGU, 45UEGW, 45UEGX, 45UEGY, 45UEGZ, 45UEHA, 45UEHB, 45UEHC, 45UEHD, 45UEHE, 45UEHF, 45UEHG, 45UEHJ, 45UEHK, 45UEHL, 45UEHM, 45UEHN, 45UEHO, 45UEHP, 45UEHQ, 45UEHR, 45UEHS, 45UEHT, 45UEHU, 45UEHV, 45UEHW, 45UEHX, 45UEHY, 45UEHZ, 47UDFT, 47UDFU, 47UDFW, 47UDFX, 47UDFY, 47UDFZ, 47UEFN, 47UEFP, 47UEFQ, 47UEFR, 47UEFS, 47UEFT, 47UEFU, 47UEFW, 47UEFX, 47UEFY, 47UEFZ, 47UEGA, 47UEGB, 47UEGC, 47UEGD, 47UGFU, 47UGFW, 47UGFZ, 47UGGB, 47UGGC, 47UGGD, 47UGGE, 47UGGF, 47UGGG, 47UGGH, 47UGGK

HHNUM (ESERIAL): Serial number of household

Columns 169/174

PAGE 1 OF 1

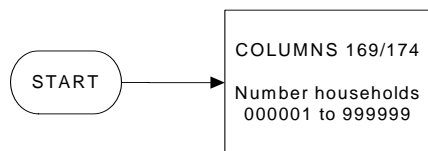

KEY
Serial number are allocated by the national statistical institutes and remain the same for all waves

HHTYPE (ETYPHLD): Type of Household

Column 175

PAGE 1 OF 1

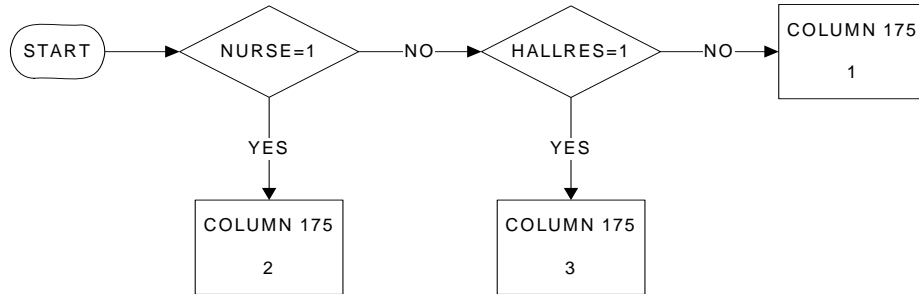

KEY

- 1 Person living in private household (or permanently in a hotel) and surveyed in this household
- 2 Person living in an institution and surveyed in this institution
- 3 Person living in an institution but surveyed in this private household
- 4 Person living in another private household on the territory of the country but surveyed in this household of origin

HHTYPE (ETYPHLD): Type of Household

Column 175

PAGE 1 OF 1

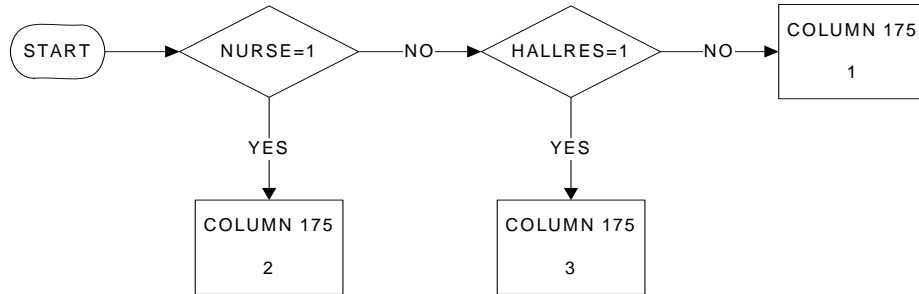

KEY

- 1 Person living in private household (or permanently in a hotel) and surveyed in this household
- 2 Person living in an institution and surveyed in this institution
- 3 Person living in an institution but surveyed in this private household
- 4 Person living in another private household on the territory of the country but surveyed in this household of origin

HHINST (ETYPINS): Type of Institution

Column 176

PAGE 1 OF 1

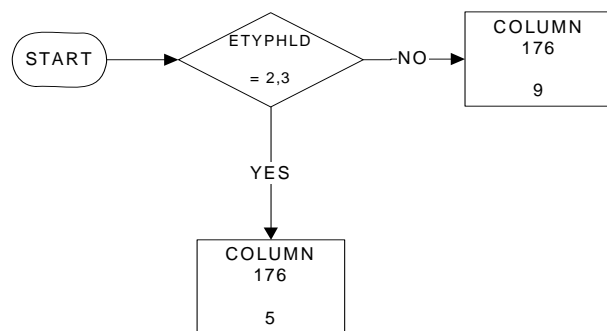

| KEY | |
|-------|--|
| 1 | Educational institution |
| 2 | Hospital |
| 3 | Other welfare institution |
| 4 | Religious institution (not already included in 1-3) |
| 5 | Workers' hostel, working quarters at building sites, student hostel, university accommodation etc. |
| 6 | Military establishment |
| 7 | Other (e.g. prison) |
| 9 | Not applicable (HHTYPE = 1,4) |
| BLANK | No answer |

COEFFY (EWEIGHT): Yearly weighting factor

Columns 177/182

PAGE 1 OF 1

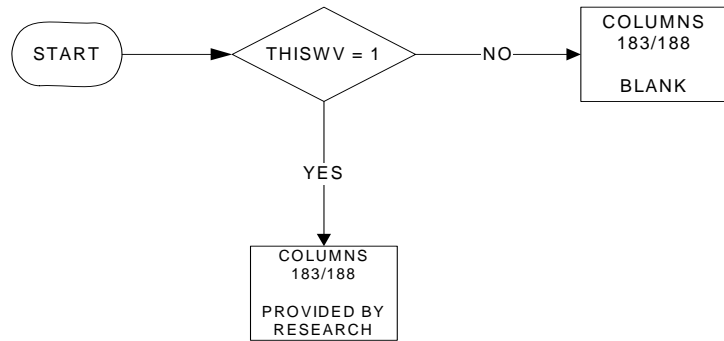

KEY

0000-9999 Cols 183-186 contain whole numbers
00-99 Cols 187-188 contain decimal places

Notes

The yearly weighting factor is provided by research by an annual weight calculated once all quarter data has been received.

COEFFQ (EQWT07): Quarterly weighting factor

Columns 183/188

PAGE 1 OF 1

START

COLUMNS 183/188

The SOEC file quarterly weighting factor will be the same as the UK file. Factor in the format XXXX.XX

KEY

0000-9999 Cols 183-186 contain whole numbers
00-99 Cols 187-188 contain decimal places

COEFFH (EQHHWT): Household yearly weighting factor of the sample for household characteristics (in the case of a sample of individuals)

Columns 189/194

PAGE 1 OF 1

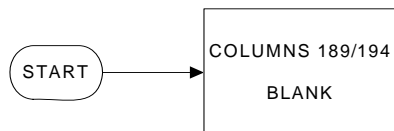

KEY

0000-9999 Cols 189-192 contain whole numbers
00-99 Cols 193-194 contain decimal places

Notes

No weight is submitted to Eurostat

INTWAVE (EWAVE): Sequence number of the survey wave

Column 195
PAGE 1 OF 1

START

COLUMN 195
RECODE EWAVE
= THISWV

KEY

1-8 Sequence number of the wave

INTQUEST (EINTQUES): Questionnaire used

Column 196
PAGE 1 OF 1

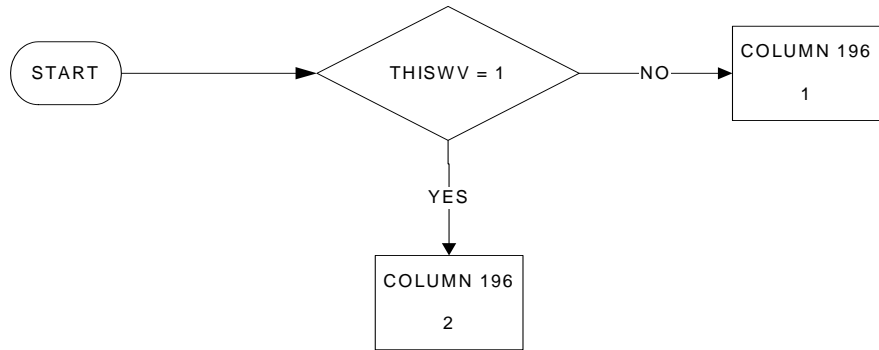

KEY

- 1 Only core variables
- 2 Whole questionnaire

Notes

This variable indicates which cases should be used for creating data on Eurostat structural variables. As this data is collected in wave 1 all quarters it is only wave one cases that can be used with the wave 1 weight (COEFFY, Col. 177-182) to generate this data. Eurostat specify that the records for which yearly variables are available should be coded as INTQUEST (Col. 196) = 2 and the records for which only quarterly variables are available should be coded as INTQUEST = 1.

ANNEX I Regional codes used in the EU Labour Force Survey from 2007 (according to the Classification of Territorial Units (NUTS))

The following codes are used to identify the regions for which data are collected in the EU LFS from 2007 onwards.

| | | |
|------|---|----------------|
| BE00 | | BELGIUM |
| BE10 | Reg. Bruxelles-Cap.- Brussels Hfdst. gewest | |
| BE21 | Antwerpen | |
| BE22 | Limburg (B) | |
| BE23 | Oost-Vlaanderen | |
| BE24 | Vlaams Brabant | |
| BE25 | West-Vlaanderen | |
| BE31 | Brabant Wallon | |
| BE32 | Hainaut | |
| BE33 | Liege | |
| BE34 | Luxembourg (B) | |
| BE35 | Namur | |
| | | |
| BG00 | | BULGARIA |
| BG31 | Severozapaden | |
| BG32 | Severen tsentralen | |
| BG33 | Severozitochten | |
| BG34 | Yugoiztochten | |
| BG41 | Yugozapaden | |
| BG42 | Yuzhen tsentralen | |
| | | |
| CZ00 | | CZECH REPUBLIC |
| CZ01 | Prague | |
| CZ02 | Central Bohemia | |
| CZ03 | Southwest | |
| CZ04 | Northwest | |
| CZ05 | Northeast | |
| CZ06 | Southeast | |
| CZ07 | Central Moravia | |
| CZ08 | Ostrava | |
| | | |
| DK00 | | DENMARK |
| DK01 | Hovedstaden | |
| DK02 | Sjælland | |
| DK03 | Syddanmark | |
| DK04 | Midtjylland | |
| DK05 | Nordjylland | |
| | | |
| DE00 | | GERMANY |
| DE11 | Stuttgart | |
| DE12 | Karlsruhe | |
| DE13 | Freiburg | |
| DE14 | Tübingen | |
| DE21 | Oberbayern | |
| DE22 | Niederbayern | |
| DE23 | Oberplatz | |
| DE24 | Oberfranken | |
| DE25 | Mittelfranken | |
| DE26 | Unterfranken | |
| DE27 | Schwaben | |
| DE30 | Berlin | |
| DE41 | Brandenburg-Nordost | |
| DE42 | Brandenburg-Südwest | |
| DE50 | Bremen | |
| DE60 | Hamburg | |
| DE71 | Darmstadt | |
| DE72 | Gießen | |
| DE73 | Kassel | |
| DE80 | Mecklenburg-Vorpommern | |
| DE91 | Braunschweig | |
| DE92 | Hannover | |
| DE93 | Lüneburg | |
| DE94 | Weser-Ems | |

Labour Force Survey - United Kingdom

| | | |
|------|------------------------------|---------|
| DEA1 | Düsseldorf | |
| DEA2 | Köln | |
| DEA3 | Münster | |
| DEA4 | Detmold | |
| DEA5 | Arnsberg | |
| DEB1 | Koblenz | |
| DEB2 | Trier | |
| DEB3 | Rheinhessen-Pfalz | |
| DEC0 | Saarland | |
| DED1 | Chemnitz | |
| DED2 | Dresden | |
| DED3 | Leipzig | |
| DEE0 | Sachsen-Anhalt | |
| DEF0 | Schleswig-Holstein | |
| DEG0 | Thüringen | |
| | | |
| EE00 | | ESTONIA |
| | | |
| IE00 | | IRELAND |
| IE01 | Border Midland and Western | |
| IE02 | Southern and Eastern | |
| | | |
| GR00 | | GREECE |
| GR11 | Anatoliki Makedonia - Thraki | |
| GR12 | Kentriki Makedonia | |
| GR13 | Dytiki Makedonia | |
| GR14 | Thessalia | |
| GR21 | Ipeiros | |
| GR22 | Ionia Nisia | |
| GR23 | Dytiki Ellada | |
| GR24 | Sterea Ellada | |
| GR25 | Peloponnisos | |
| GR30 | Attiki | |
| GR41 | Voreio Aigaio | |
| GR42 | Notio Aigaio | |
| GR43 | Kriti | |
| | | |
| ES00 | | SPAIN |
| ES11 | Galicia | |
| ES12 | Principado de Asturias | |
| ES13 | Cantabria | |
| ES21 | Pais Vasco | |
| ES22 | Comunidad Foral de Navarra | |
| ES23 | La Rioja | |
| ES24 | Aragón | |
| ES30 | Comunidad de Madrid | |
| ES41 | Castilla y Leon | |
| ES42 | Castilla la Mancha | |
| ES43 | Extremadura | |
| ES51 | Cataluna | |
| ES52 | Comunidad Valenciana | |
| ES53 | Islas Baleares | |
| ES61 | Andalucia | |
| ES62 | Region de Murcia | |
| ES63 | Ciudad Autónoma de Ceuta | |
| ES64 | Ciudad Autónoma de Melilla | |
| ES70 | Canarias | |
| | | |
| FR00 | | FRANCE |
| FR10 | ile de France | |
| FR21 | Champagne-Ardenne | |
| FR22 | Picardie | |
| FR23 | Haute-Normandie | |
| FR24 | Centre | |
| FR25 | Basse-Normandie | |
| FR26 | Bourgogne | |
| FR30 | Nord - Pas-de-Calais | |
| FR41 | Lorraine | |
| FR42 | Alsace | |

Labour Force Survey - United Kingdom

| | | |
|------|----------------------------------|-----------------|
| FR43 | Franche-Comte | |
| FR51 | Pays de la Loire | |
| FR52 | Bretagne | |
| FR53 | Poitou-Charentes | |
| FR61 | Aquitaine | |
| FR62 | Midi-Pyrenees | |
| FR63 | Limousin | |
| FR71 | Rhone-Alpes | |
| FR72 | Auvergne | |
| FR81 | Languedoc-Roussillon | |
| FR82 | Provence-Alpes-Cote d Azur | |
| FR83 | Corse | |
| FR91 | Guadeloupe | |
| FR92 | Martinique | |
| FR93 | Guyane | |
| FR94 | Reunion | |
| | | |
| IT00 | | ITALY |
| ITC1 | Piemonte | |
| ITC2 | Valle d Aosta/Vallée d Aoste | |
| ITC3 | Liguria | |
| ITC4 | Lombardia | |
| ITD1 | Provincia autonoma Bolzano/Bozen | |
| ITD2 | Provincia autonoma Trento | |
| ITD3 | Veneto | |
| ITD4 | Friuli-Venezia Giulia | |
| ITD5 | Emilia-Romagna | |
| ITE1 | Toscana | |
| ITE2 | Umbria | |
| ITE3 | Marche | |
| ITE4 | Lazio | |
| ITF1 | Abruzzo | |
| ITF2 | Molise | |
| ITF3 | Campania | |
| ITF4 | Puglia | |
| ITF5 | Basilicata | |
| ITF6 | Calabria | |
| ITG1 | Sicilia | |
| ITG2 | Sardegna | |
| | | |
| CY00 | | CYPRUS |
| | | |
| LV00 | | LATVIA |
| | | |
| LT00 | | LITUANIA |
| | | |
| LU00 | | LUXEMBOURG |
| | | |
| HU00 | | HUNGARY |
| HU10 | Kozep-Magyarország | |
| HU21 | Kozep-Dunantul | |
| HU22 | Nyugat-Dunantul | |
| HU23 | Del- Dunantul | |
| HU31 | Eszak-Magyarország | |
| HU32 | Eszak-Alfold | |
| HU33 | Del-Alfold | |
| | | |
| MT00 | | MALTA |
| | | |
| NL00 | | THE NETHERLANDS |
| NL11 | Groningen | |
| NL12 | Friesland (NL) | |
| NL13 | Drenthe | |
| NL21 | Overijssel | |
| NL22 | Gelderland | |
| NL23 | Flevoland | |
| NL31 | Utrecht | |
| NL32 | Noord-Holland | |
| NL33 | Zuid-Holland | |

Labour Force Survey - United Kingdom

| | | |
|------|----------------------------|-----------------|
| NL34 | Zeeland | |
| NL41 | Noord-Brabant | |
| NL42 | Limburg (NL) | |
| | | |
| AT00 | | AUSTRIA |
| AT11 | Burgenland (A) | |
| AT12 | Niederosterreich | |
| AT13 | Wien | |
| AT21 | Karnten | |
| AT22 | Steiermark | |
| AT31 | Oberosterreich | |
| AT32 | Salzburg | |
| AT33 | Tirol | |
| AT34 | Vorarlberg | |
| | | |
| PL00 | | POLAND |
| PL11 | Lodzkie | |
| PL12 | Mazowieckie | |
| PL21 | Malopolskie | |
| PL22 | Slaskie | |
| PL31 | Lubelskie | |
| PL32 | Podkarpackie | |
| PL33 | Swietokrzyskie | |
| PL34 | Podlaskie | |
| PL41 | Wielkopolskie | |
| PL42 | Zachodniopomorskie | |
| PL43 | Lubuskie | |
| PL51 | Dolnoslaskie | |
| PL52 | Opolskie | |
| PL61 | Kujawsko-Pomorskie | |
| PL62 | Warminsko-Mazurskie | |
| PL63 | Pomorskie | |
| | | |
| PT00 | | PORTUGAL |
| PT11 | Norte | |
| PT15 | Algarve | |
| PT16 | Centro (P) | |
| PT17 | Lisboa | |
| PT18 | Alentejo | |
| PT20 | Região Autónoma dos Açores | |
| PT30 | Região Autónoma da Madeira | |
| | | |
| RO00 | | ROMANIA |
| RO11 | Nord-Vest | |
| RO12 | Centru | |
| RO21 | Nord-Est | |
| RO22 | Sud-Est | |
| RO31 | Sud-Muntenia | |
| RO32 | Bucuresti-Ilfov | |
| RO41 | Sud-Vest Oltenia | |
| RO42 | Vest | |
| | | |
| SI00 | | SLOVENIA |
| SI01 | Vzhodna Slovenija | |
| SI02 | Zahodna Slovenija | |
| | | |
| SK00 | | SLOVAK REPUBLIC |
| SK01 | Bratislava | |
| SK02 | Western Slovakia | |
| SK03 | Central Slovakia | |
| SK04 | Eastern Slovakia | |
| | | |
| FI00 | | FINLAND |
| FI13 | Itä-Suomi | |
| FI18 | Etelä-Suomi | |
| FI19 | Länsi-Suomi | |
| FI1A | Pohjois-Suomi | |
| FI20 | Åland | |
| | | |

Labour Force Survey - United Kingdom

| | | |
|------|---|----------------|
| SE00 | | SWEDEN |
| SE11 | Stockholm | |
| SE12 | Östra Mellansverige | |
| SE21 | Småland med öarna | |
| SE22 | Sydsverige | |
| SE23 | Västsverige | |
| SE31 | Norra Mellansverige | |
| SE32 | Mellersta Norrland | |
| SE33 | Övre Norrland | |
| | | |
| UK00 | | UNITED KINGDOM |
| UKC1 | Tees Valley - Durham | |
| UKC2 | Northumberland - Tyne and Wear | |
| UKD1 | Cumbria | |
| UKD2 | Cheshire | |
| UKD3 | Greater Manchester | |
| UKD4 | Lancashire | |
| UKD5 | Merseyside | |
| UKE1 | East Yorkshire and Northern Lincolnshire | |
| UKE2 | North Yorkshire | |
| UKE3 | South Yorkshire | |
| UKE4 | West Yorkshire | |
| UKF1 | Derbyshire Nottinghamshire | |
| UKF2 | Leicestershire - Northamptonshire | |
| UKF3 | Lincolnshire | |
| UKG1 | Herefordshire - Worcestershire - Warwickshire | |
| UKG2 | Shropshire - Staffordshire | |
| UKG3 | West Midlands | |
| UKH1 | East Anglia | |
| UKH2 | Bedfordshire - Hertfordshire | |
| UKH3 | Essex | |
| UKI1 | Inner London | |
| UKI2 | Outer London | |
| UKJ1 | Berkshire - Bucks - Oxfordshire | |
| UKJ2 | Surrey - East-West Sussex | |
| UKJ3 | Hampshire - Isle of Wight | |
| UKJ4 | Kent | |
| UKK1 | Gloucestershire - Wiltshire - Bristol - Bath Area | |
| UKK2 | Dorset - Somerset | |
| UKK3 | Cornwall - Isles of Scilly | |
| UKK4 | Devon | |
| UKL1 | West Wales - the Valleys | |
| UKL2 | East Wales | |
| UKM2 | Eastern Scotland | |
| UKM3 | South Western Scotland | |
| UKM5 | North Eastern Scotland | |
| UKM6 | Highlands - Islands | |
| UKN0 | Northern Ireland | |
| | | |
| HR00 | | CROATIA |
| HR01 | Sjeverozapadna Hrvatska | |
| HR02 | Sredisnja i Istocna (Panonska) Hrvatska | |
| HR03 | Jadranska Hrvatska | |
| | | |
| MK00 | | FYRMAKEDONIA |
| | | |
| TR00 | | TURKEY |
| TR10 | Istanbul | |
| TR21 | Tekirdag | |
| TR22 | Balikesir | |
| TR31 | Izmir | |
| TR32 | Aydin | |
| TR33 | Manisa | |
| TR41 | Bursa | |
| TR42 | Kocaeli | |
| TR51 | Ankara | |
| TR52 | Konia | |
| TR61 | Antalya | |
| TR62 | Adana | |

Labour Force Survey - United Kingdom

| | | |
|------|--------------------|---------------|
| TR63 | Hatay | |
| TR71 | Kirrikale | |
| TR72 | Kayseri | |
| TR81 | Zonguldak | |
| TR82 | Kastamonu | |
| TR83 | Samsun | |
| TR90 | Trabzon | |
| TRA1 | Erzurum | |
| TRA2 | Agri | |
| TRB1 | Malatya | |
| TRB2 | Van | |
| TRC1 | Gaziantep | |
| TRC2 | Sanliurfa | |
| TRC3 | Mardin | |
| | | |
| CH00 | | SWITZERLAND |
| CH01 | Region lemanique | |
| CH02 | Espace Mittelland | |
| CH03 | Nordwestschweiz | |
| CH04 | Zurich | |
| CH05 | Ostschweiz | |
| CH06 | Zentralschweiz | |
| CH07 | Ticino | |
| | | |
| IS00 | | ICELAND |
| | | |
| LI00 | | LIECHTENSTEIN |
| | | |
| NO00 | | NORWAY |
| NO01 | Oslo og Akershus | |
| NO02 | Hedmark og Oppland | |
| NO03 | Soer-Ostlandet | |
| NO04 | Agder og Rogaland | |
| NO05 | Vestlandet | |
| NO06 | Troendelag | |
| NO07 | Nord-Norge | |

ANNEX II **Statistical Classification of economic activities at 2 and 3 digits**
(NACE Rev. 2 – used from 2009 onwards)

| | |
|----------|--|
| <i>A</i> | <i>AGRICULTURE, FORESTRY AND FISHING</i> |
| 01 | Crop and animal production, hunting and related service activities |
| 01.1 | Growing of non-perennial crops |
| 01.2 | Growing of perennial crops |
| 01.3 | Plant propagation |
| 01.4 | Animal production |
| 01.5 | Mixed farming |
| 01.6 | Support activities to agriculture and post-harvest crop activities |
| 01.7 | Hunting, trapping and related service activities |
| 02 | Forestry and logging |
| 02.1 | Silviculture and other forestry activities |
| 02.2 | Logging |
| 02.3 | Gathering of wild growing non-wood products |
| 02.4 | Support services to forestry |
| 03 | Fishing and aquaculture |
| 03.1 | Fishing |
| 03.2 | Aquaculture |
| <i>B</i> | <i>MINING AND QUARRYING</i> |
| 05 | Mining of coal and lignite |
| 05.1 | Mining of hard coal |
| 05.2 | Mining of lignite |
| 06 | Extraction of crude petroleum and natural gas |
| 06.1 | Extraction of crude petroleum |
| 06.2 | Extraction of natural gas |
| 07 | Mining of metal ores |
| 07.1 | Mining of iron ores |
| 07.2 | Mining of non-ferrous metal ores |
| 08 | Other mining and quarrying |
| 08.1 | Quarrying of stone, sand and clay |
| 08.9 | Mining and quarrying n.e.c. |
| 09 | Mining support service activities |
| 09.1 | Support activities for petroleum and natural gas extraction |
| 09.9 | Support activities for other mining and quarrying |
| <i>C</i> | <i>MANUFACTURING</i> |
| 10 | Manufacture of food products |
| 10.1 | Processing and preserving of meat and production of meat products |
| 10.2 | Processing and preserving of fish, crustaceans and molluscs |
| 10.3 | Processing and preserving of fruit and vegetables |
| 10.4 | Manufacture of vegetable and animal oils and fats |
| 10.5 | Manufacture of dairy products |

| | |
|------|---|
| 10.6 | Manufacture of grain mill products, starches and starch products |
| 10.7 | Manufacture of bakery and farinaceous products |
| 10.8 | Manufacture of other food products |
| 10.9 | Manufacture of prepared animal feeds |
| 11 | Manufacture of beverages |
| 11.0 | Manufacture of beverages |
| 12 | Manufacture of tobacco products |
| 12.0 | Manufacture of tobacco products |
| 13 | Manufacture of textiles |
| 13.1 | Preparation and spinning of textile fibres |
| 13.2 | Weaving of textiles |
| 13.3 | Finishing of textiles |
| 13.9 | Manufacture of other textiles |
| 14 | Manufacture of wearing apparel |
| 14.1 | Manufacture of wearing apparel, except fur apparel |
| 14.2 | Manufacture of articles of fur |
| 14.3 | Manufacture of knitted and crocheted apparel |
| 15 | Manufacture of leather and related products |
| 15.1 | Tanning and dressing of leather; manufacture of luggage, handbags, saddlery and harness; dressing and dyeing of fur |
| 15.2 | Manufacture of footwear |
| 16 | Manufacture of wood and of products of wood and cork, except furniture; manufacture of articles of straw and plaiting materials |
| 16.1 | Sawmilling and planing of wood |
| 16.2 | Manufacture of products of wood, cork, straw and plaiting materials |
| 17 | Manufacture of paper and paper products |
| 17.1 | Manufacture of pulp, paper and paperboard |
| 17.2 | Manufacture of articles of paper and paperboard |
| 18 | Printing and reproduction of recorded media |
| 18.1 | Printing and service activities related to printing |
| 18.2 | Reproduction of recorded media |
| 19 | Manufacture of coke and refined petroleum products |
| 19.1 | Manufacture of coke oven products |
| 19.2 | Manufacture of refined petroleum products |
| 20 | Manufacture of chemicals and chemical products |
| 20.1 | Manufacture of basic chemicals, fertilisers and nitrogen compounds, plastics and synthetic rubber in primary forms |
| 20.2 | Manufacture of pesticides and other agrochemical products |
| 20.3 | Manufacture of paints, varnishes and similar coatings, printing ink and mastics |
| 20.4 | Manufacture of soap and detergents, cleaning and polishing preparations, perfumes and toilet preparations |
| 20.5 | Manufacture of other chemical products |
| 20.6 | Manufacture of man-made fibres |
| 21 | Manufacture of basic pharmaceutical products and pharmaceutical preparations |
| 21.1 | Manufacture of basic pharmaceutical products |
| 21.2 | Manufacture of pharmaceutical preparations |
| 22 | Manufacture of rubber and plastic products |
| 22.1 | Manufacture of rubber products |
| 22.2 | Manufacture of plastics products |
| 23 | Manufacture of other non-metallic mineral products |
| 23.1 | Manufacture of glass and glass products |
| 23.2 | Manufacture of refractory products |

| | |
|------|---|
| 23.3 | Manufacture of clay building materials |
| 23.4 | Manufacture of other porcelain and ceramic products |
| 23.5 | Manufacture of cement, lime and plaster |
| 23.6 | Manufacture of articles of concrete, cement and plaster |
| 23.7 | Cutting, shaping and finishing of stone |
| 23.9 | Manufacture of abrasive products and non-metallic mineral products n.e.c. |
| 24 | Manufacture of basic metals |
| 24.1 | Manufacture of basic iron and steel and of ferro-alloys |
| 24.2 | Manufacture of tubes, pipes, hollow profiles and related fittings, of steel |
| 24.3 | Manufacture of other products of first processing of steel |
| 24.4 | Manufacture of basic precious and other non-ferrous metals |
| 24.5 | Casting of metals |
| 25 | Manufacture of fabricated metal products, except machinery and equipment |
| 25.1 | Manufacture of structural metal products |
| 25.2 | Manufacture of tanks, reservoirs and containers of metal |
| 25.3 | Manufacture of steam generators, except central heating hot water boilers |
| 25.4 | Manufacture of weapons and ammunition |
| 25.5 | Forging, pressing, stamping and roll-forming of metal; powder metallurgy |
| 25.6 | Treatment and coating of metals; machining |
| 25.7 | Manufacture of cutlery, tools and general hardware |
| 25.9 | Manufacture of other fabricated metal products |
| 26 | Manufacture of computer, electronic and optical products |
| 26.1 | Manufacture of electronic components and boards |
| 26.2 | Manufacture of computers and peripheral equipment |
| 26.3 | Manufacture of communication equipment |
| 26.4 | Manufacture of consumer electronics |
| 26.5 | Manufacture of instruments and appliances for measuring, testing and navigation; watches and clocks |
| 26.6 | Manufacture of irradiation, electromedical and electrotherapeutic equipment |
| 26.7 | Manufacture of optical instruments and photographic equipment |
| 26.8 | Manufacture of magnetic and optical media |
| 27 | Manufacture of electrical equipment |
| 27.1 | Manufacture of electric motors, generators, transformers and electricity distribution and control apparatus |
| 27.2 | Manufacture of batteries and accumulators |
| 27.3 | Manufacture of wiring and wiring devices |
| 27.4 | Manufacture of electric lighting equipment |
| 27.5 | Manufacture of domestic appliances |
| 27.9 | Manufacture of other electrical equipment |
| 28 | Manufacture of machinery and equipment n.e.c. |
| 28.1 | Manufacture of general — purpose machinery |
| 28.2 | Manufacture of other general-purpose machinery |
| 28.3 | Manufacture of agricultural and forestry machinery |
| 28.4 | Manufacture of metal forming machinery and machine tools |
| 28.9 | Manufacture of other special-purpose machinery |
| 29 | Manufacture of motor vehicles, trailers and semi-trailers |
| 29.1 | Manufacture of motor vehicles |
| 29.2 | Manufacture of bodies (coachwork) for motor vehicles; manufacture of trailers and semi-trailers |
| 29.3 | Manufacture of parts and accessories for motor vehicles |
| 30 | Manufacture of other transport equipment |
| 30.1 | Building of ships and boats |

| | |
|----------|--|
| 30.2 | Manufacture of railway locomotives and rolling stock |
| 30.3 | Manufacture of air and spacecraft and related machinery |
| 30.4 | Manufacture of military fighting vehicles |
| 30.9 | Manufacture of transport equipment n.e.c. |
| 31 | Manufacture of furniture |
| 31.0 | Manufacture of furniture |
| 32 | Other manufacturing |
| 32.1 | Manufacture of jewellery, bijouterie and related articles |
| 32.2 | Manufacture of musical instruments |
| 32.3 | Manufacture of sports goods |
| 32.4 | Manufacture of games and toys |
| 32.5 | Manufacture of medical and dental instruments and supplies |
| 32.9 | Manufacturing n.e.c. |
| 33 | Repair and installation of machinery and equipment |
| 33.1 | Repair of fabricated metal products, machinery and equipment |
| 33.2 | Installation of industrial machinery and equipment |
| <i>D</i> | <i>ELECTRICITY, GAS, STEAM AND AIR CONDITIONING SUPPLY</i> |
| 35 | Electricity, gas, steam and air conditioning supply |
| 35.1 | Electric power generation, transmission and distribution |
| 35.2 | Manufacture of gas; distribution of gaseous fuels through mains |
| 35.3 | Steam and air conditioning supply |
| <i>E</i> | <i>WATER SUPPLY; SEWERAGE, WASTE MANAGEMENT AND REMEDIATION ACTIVITIES</i> |
| 36 | Water collection, treatment and supply |
| 36.0 | Water collection, treatment and supply |
| 37 | Sewerage |
| 37.0 | Sewerage |
| 38 | Waste collection, treatment and disposal activities; materials recovery |
| 38.1 | Waste collection |
| 38.2 | Waste treatment and disposal |
| 38.3 | Materials recovery |
| 39 | Remediation activities and other waste management services |
| 39.0 | Remediation activities and other waste management services |
| <i>F</i> | <i>CONSTRUCTION</i> |
| 41 | Construction of buildings |
| 41.1 | Development of building projects |
| 41.2 | Construction of residential and non-residential buildings |
| 42 | Civil engineering |
| 42.1 | Construction of roads and railways |
| 42.2 | Construction of utility projects |
| 42.9 | Construction of other civil engineering projects |
| 43 | Specialised construction activities |
| 43.1 | Demolition and site preparation |
| 43.2 | Electrical, plumbing and other construction installation activities |

| | |
|----------|---|
| 43.3 | Building completion and finishing |
| 43.9 | Other specialised construction activities |
| <i>G</i> | <i>WHOLESALE AND RETAIL TRADE; REPAIR OF MOTOR VEHICLES AND MOTORCYCLES</i> |
| 45 | Wholesale and retail trade and repair of motor vehicles and motorcycles |
| 45.1 | Sale of motor vehicles |
| 45.2 | Maintenance and repair of motor vehicles |
| 45.3 | Sale of motor vehicle parts and accessories |
| 45.4 | Sale, maintenance and repair of motorcycles and related parts and accessories |
| 46 | Wholesale trade, except of motor vehicles and motorcycles |
| 46.2 | Wholesale of agricultural raw materials and live animals |
| 46.3 | Wholesale of food, beverages and tobacco |
| 46.4 | Wholesale of household goods |
| 46.5 | Wholesale of information and communication equipment |
| 46.6 | Wholesale of other machinery, equipment and supplies |
| 46.7 | Other specialised wholesale |
| 46.9 | Non-specialised wholesale trade |
| 47 | Retail trade, except of motor vehicles and motorcycles |
| 47.1 | Retail sale in non-specialised stores |
| 47.2 | Retail sale of food, beverages and tobacco in specialised stores |
| 47.3 | Retail sale of automotive fuel in specialised stores |
| 47.4 | Retail sale of information and communication equipment in specialised stores |
| 47.5 | Retail sale of other household equipment in specialised stores |
| 47.6 | Retail sale of cultural and recreation goods in specialised stores |
| 47.7 | Retail sale of other goods in specialised stores |
| 47.8 | Retail sale via stalls and markets |
| 47.9 | Retail trade not in stores, stalls or markets |
| <i>H</i> | <i>TRANSPORTATION AND STORAGE</i> |
| 49 | Land transport and transport via pipelines |
| 49.1 | Passenger rail transport, interurban |
| 49.2 | Freight rail transport |
| 49.3 | Other passenger land transport |
| 49.4 | Freight transport by road and removal services |
| 49.5 | Transport via pipeline |
| 50 | Water transport |
| 50.1 | Sea and coastal passenger water transport |
| 50.2 | Sea and coastal freight water transport |
| 50.3 | Inland passenger water transport |
| 50.4 | Inland freight water transport |
| 51 | Air transport |
| 51.1 | Passenger air transport |
| 51.2 | Freight air transport and space transport |
| 52 | Warehousing and support activities for transportation |
| 52.1 | Warehousing and storage |
| 52.2 | Support activities for transportation |
| 53 | Postal and courier activities |

| | |
|----------|--|
| 53.1 | Postal activities under universal service obligation |
| 53.2 | Other postal and courier activities |
| <i>I</i> | <i>ACCOMMODATION AND FOOD SERVICE ACTIVITIES</i> |
| 55 | Accommodation |
| 55.1 | Hotels and similar accommodation |
| 55.2 | Holiday and other short-stay accommodation |
| 55.3 | Camping grounds, recreational vehicle parks and trailer parks |
| 55.9 | Other accommodation |
| 56 | Food and beverage service activities |
| 56.1 | Restaurants and mobile food service activities |
| 56.2 | Event catering and other food service activities |
| 56.3 | Beverage serving activities |
| <i>J</i> | <i>INFORMATION AND COMMUNICATION</i> |
| 58 | Publishing activities |
| 58.1 | Publishing of books, periodicals and other publishing activities |
| 58.2 | Software publishing |
| 59 | Motion picture, video and television programme production, sound recording and music publishing activities |
| 59.1 | Motion picture, video and television programme activities |
| 59.2 | Sound recording and music publishing activities |
| 60 | Programming and broadcasting activities |
| 60.1 | Radio broadcasting |
| 60.2 | Television programming and broadcasting activities |
| 61 | Telecommunications |
| 61.1 | Wired telecommunications activities |
| 61.2 | Wireless telecommunications activities |
| 61.3 | Satellite telecommunications activities |
| 61.9 | Other telecommunications activities |
| 62 | Computer programming, consultancy and related activities |
| 62.0 | Computer programming, consultancy and related activities |
| 63 | Information service activities |
| 63.1 | Data processing, hosting and related activities; web portals |
| 63.9 | Other information service activities |
| <i>K</i> | <i>FINANCIAL AND INSURANCE ACTIVITIES</i> |
| 64 | Financial service activities, except insurance and pension funding |
| 64.1 | Monetary intermediation |
| 64.2 | Activities of holding companies |
| 64.3 | Trusts, funds and similar financial entities |
| 64.9 | Other financial service activities, except insurance and pension funding |
| 65 | Insurance, reinsurance and pension funding, except compulsory social security |
| 65.1 | Insurance |
| 65.2 | Reinsurance |
| 65.3 | Pension funding |
| 66 | Activities auxiliary to financial services and insurance activities |

- 66.1 Activities auxiliary to financial services, except insurance and pension funding
- 66.2 Activities auxiliary to insurance and pension funding
- 66.3 Fund management activities

L REAL ESTATE ACTIVITIES

- 68 Real estate activities
- 68.1 Buying and selling of own real estate
- 68.2 Renting and operating of own or leased real estate
- 68.3 Real estate activities on a fee or contract basis

M PROFESSIONAL, SCIENTIFIC AND TECHNICAL ACTIVITIES

- 69 Legal and accounting activities
- 69.1 Legal activities
- 69.2 Accounting, bookkeeping and auditing activities; tax consultancy
- 70 Activities of head offices; management consultancy activities
- 70.1 Activities of head offices
- 70.2 Management consultancy activities
- 71 Architectural and engineering activities; technical testing and analysis
- 71.1 Architectural and engineering activities and related technical consultancy
- 71.2 Technical testing and analysis
- 72 Scientific research and development
- 72.1 Research and experimental development on natural sciences and engineering
- 72.2 Research and experimental development on social sciences and humanities
- 73 Advertising and market research
- 73.1 Advertising
- 73.2 Market research and public opinion polling
- 74 Other professional, scientific and technical activities
- 74.1 Specialised design activities
- 74.2 Photographic activities
- 74.3 Translation and interpretation activities
- 74.9 Other professional, scientific and technical activities n.e.c.
- 75 Veterinary activities
- 75.0 Veterinary activities

N ADMINISTRATIVE AND SUPPORT SERVICE ACTIVITIES

- 77 Rental and leasing activities
- 77.1 Renting and leasing of motor vehicles
- 77.2 Renting and leasing of personal and household goods
- 77.3 Renting and leasing of other machinery, equipment and tangible goods
- 77.4 Leasing of intellectual property and similar products, except copyrighted works
- 78 Employment activities
- 78.1 Activities of employment placement agencies
- 78.2 Temporary employment agency activities
- 78.3 Other human resources provision
- 79 Travel agency, tour operator reservation service and related activities
- 79.1 Travel agency and tour operator activities

| | |
|----------|---|
| 79.9 | Other reservation service and related activities |
| 80 | Security and investigation activities |
| 80.1 | Private security activities |
| 80.2 | Security systems service activities |
| 80.3 | Investigation activities |
| 81 | Services to buildings and landscape activities |
| 81.1 | Combined facilities support activities |
| 81.2 | Cleaning activities |
| 81.3 | Landscape service activities |
| 82 | Office administrative, office support and other business support activities |
| 82.1 | Office administrative and support activities |
| 82.2 | Activities of call centres |
| 82.3 | Organisation of conventions and trade shows |
| 82.9 | Business support service activities n.e.c. |
| <i>O</i> | <i>PUBLIC ADMINISTRATION AND DEFENCE; COMPULSORY SOCIAL SECURITY</i> |
| 84 | Public administration and defence; compulsory social security |
| 84.1 | Administration of the State and the economic and social policy of the community |
| 84.2 | Provision of services to the community as a whole |
| 84.3 | Compulsory social security activities |
| <i>P</i> | <i>EDUCATION</i> |
| 85 | Education |
| 85.1 | Pre-primary education |
| 85.2 | Primary education |
| 85.3 | Secondary education |
| 85.4 | Higher education |
| 85.5 | Other education |
| 85.6 | Educational support activities |
| <i>Q</i> | <i>HUMAN HEALTH AND SOCIAL WORK ACTIVITIES</i> |
| 86 | Human health activities |
| 86.1 | Hospital activities |
| 86.2 | Medical and dental practice activities |
| 86.9 | Other human health activities |
| 87 | Residential care activities |
| 87.1 | Residential nursing care activities |
| 87.2 | Residential care activities for mental retardation, mental health and substance abuse |
| 87.3 | Residential care activities for the elderly and disabled |
| 87.9 | Other residential care activities |
| 88 | Social work activities without accommodation |
| 88.1 | Social work activities without accommodation for the elderly and disabled |
| 88.9 | Other social work activities without accommodation |
| <i>R</i> | <i>ARTS, ENTERTAINMENT AND RECREATION</i> |

| | |
|----------|--|
| 90 | Creative, arts and entertainment activities |
| 90.0 | Creative, arts and entertainment activities |
| 91 | Libraries, archives, museums and other cultural activities |
| 91.0 | Libraries, archives, museums and other cultural activities |
| 92 | Gambling and betting activities |
| 92.0 | Gambling and betting activities |
| 93 | Sports activities and amusement and recreation activities |
| 93.1 | Sports activities |
| 93.2 | Amusement and recreation activities |
| <i>S</i> | <i>OTHER SERVICE ACTIVITIES</i> |
| 94 | Activities of membership organisations |
| 94.1 | Activities of business, employers and professional membership organisations |
| 94.2 | Activities of trade unions |
| 94.9 | Activities of other membership organisations |
| 95 | Repair of computers and personal and household goods |
| 95.1 | Repair of computers and communication equipment |
| 95.2 | Repair of personal and household goods |
| 96 | Other personal service activities |
| 96.0 | Other personal service activities |
| <i>T</i> | <i>ACTIVITIES OF HOUSEHOLDS AS EMPLOYERS; UNDIFFERENTIATED GOODS- AND SERVICES- PRODUCING ACTIVITIES OF HOUSEHOLDS FOR OWN USE</i> |
| 97 | Activities of households as employers of domestic personnel |
| 97.0 | Activities of households as employers of domestic personnel |
| 98 | Undifferentiated goods- and services-producing activities of private households for own use |
| 98.1 | Undifferentiated goods-producing activities of private households for own use |
| 98.2 | Undifferentiated service-producing activities of private households for own use |
| <i>U</i> | <i>ACTIVITIES OF EXTRATERRITORIAL ORGANISATIONS AND BODIES</i> |
| 99 | Activities of extraterritorial organisations and bodies |
| 99.0 | Activities of extraterritorial organisations and bodies |

ANNEX III – International Standard classification of occupations 2, 3 and 4 digits (ISCO-88 (com))

MAJOR GROUP 1: LEGISLATORS, SENIOR OFFICIALS AND MANAGERS

| | |
|-----|---|
| 11 | Legislators and senior officials |
| 111 | Legislators and senior government officials |
| | 1110 Legislators and senior government officials |
| 114 | Senior officials of special-interest organisations |
| | 1141 Senior officials of political party organisations |
| | 1142 Senior officials of employers', workers' and other economic-interest organisations |
| | 1143 Senior officials of humanitarian and other special-interest organisations |
| 12 | Corporate managers |
| 121 | Directors and chief executives |
| | 1210 Directors and chief executives |
| 122 | Production and operations managers |
| | 1221 Production and operations managers in agriculture, hunting, forestry and fishing |
| | 1222 Production and operations managers in manufacturing |
| | 1223 Production and operations managers in construction |
| | 1224 Production and operations managers in wholesale and retail trade |
| | 1225 Production and operations managers in restaurants and hotels |
| | 1226 Production and operations managers in transport, storage and communications |
| | 1227 Production and operations managers in business services enterprises |
| | 1228 Production and operations managers in personal care, cleaning and related services |
| | 1229 Production and operations managers not elsewhere classified |
| 123 | Other specialist managers |
| | 1231 Finance and administration managers |
| | 1232 Personnel and industrial relations managers |
| | 1233 Sales and marketing managers |
| | 1234 Advertising and public relations managers |
| | 1235 Supply and distribution managers |
| | 1236 Computing services managers |
| | 1237 Research and development managers |
| | 1239 Other specialist managers not elsewhere classified |
| 13 | Managers of small enterprises |
| 131 | Managers of small enterprises |
| | 1311 Managers of small enterprises in agriculture, hunting, forestry and fishing |
| | 1312 Managers of small enterprises in manufacturing |
| | 1313 Managers of small enterprises in construction |
| | 1314 Managers of small enterprises in wholesale and retail trade |
| | 1315 Managers of small enterprises of restaurants and hotels |
| | 1316 Managers of small enterprises in transport, storage and communications |
| | 1317 Managers of small enterprises in business services enterprises |
| | 1318 Managers of small enterprises in personal care, cleaning and related services |
| | 1319 Managers of small enterprises not elsewhere classified |

MAJOR GROUP 2: PROFESSIONALS

| | |
|-----|--|
| 21 | Physical, mathematical and engineering science professionals |
| 211 | Physicists, chemists and related professionals |
| | 2111 Physicists and astronomers |
| | 2112 Meteorologists |
| | 2113 Chemists |
| | 2114 Geologists and geophysicists |
| 212 | Mathematicians, statisticians and related professionals |
| | 2121 Mathematicians and related professionals |
| | 2122 Statisticians |
| 213 | Computing professionals |
| | 2131 Computer systems designers, analysts and programmers |
| | 2139 Computing professionals not elsewhere classified |
| 214 | Architects, engineers and related professionals |

Labour Force Survey - United Kingdom

| | | |
|----|---------------------------------------|--|
| | 2141 | Architects, town and traffic planners |
| | 2142 | Civil engineers |
| | 2143 | Electrical engineers |
| | 2144 | Electronics and telecommunications engineers |
| | 2145 | Mechanical engineers |
| | 2146 | Chemical engineers |
| | 2147 | Mining engineers, metallurgists and related professionals |
| | 2148 | Cartographers and surveyors |
| | 2149 | Architects, engineers and related professionals not elsewhere classified |
| 22 | Life science and health professionals | |
| | 221 | Life science professionals |
| | 2211 | Biologists, botanists, zoologists and related professionals |
| | 2212 | Pharmacologists, pathologists and related professionals |
| | 2213 | Agronomists and related professionals |
| | 222 | Health professionals (except nursing) |
| | 2221 | Medical doctors |
| | 2222 | Dentists |
| | 2223 | Veterinarians |
| | 2224 | Pharmacists |
| | 2229 | Health professionals (except nursing) not elsewhere classified |
| | 223 | Nursing and midwifery professionals |
| | 2230 | Nursing and midwifery professionals |
| 23 | Teaching professionals | |
| | 231 | College, university and higher education teaching professionals |
| | 2310 | College, university and higher education teaching professionals |
| | 232 | Secondary education teaching professionals |
| | 2320 | Secondary education teaching professionals |
| | 233 | Primary and pre-primary education teaching professionals |
| | 2331 | Primary education teaching professionals |
| | 2332 | Pre-primary education teaching professionals |
| | 234 | Special education teaching professionals |
| | 2340 | Special education teaching professionals |
| | 235 | Other teaching professionals |
| | 2351 | Education methods specialists |
| | 2352 | School inspectors |
| | 2359 | Other teaching professionals not elsewhere classified |
| 24 | Other professionals | |
| | 241 | Business professionals |
| | 2411 | Accountants |
| | 2412 | Personnel and careers professionals |
| | 2419 | Business professionals not elsewhere classified |
| | 242 | Legal professionals |
| | 2421 | Lawyers |
| | 2422 | Judges |
| | 2429 | Legal professionals not elsewhere classified |
| | 243 | Archivists, librarians and related information professionals |
| | 2431 | Archivists and curators |
| | 2432 | Librarians and related information professionals |
| | 244 | Social science and related professionals |
| | 2441 | Economists |
| | 2442 | Sociologists, anthropologists and related professionals |
| | 2443 | Philosophers, historians and political scientists |
| | 2444 | Philologists, translators and interpreters |
| | 2445 | Psychologists |
| | 2446 | Social work professionals |
| | 245 | Writers and creative or performing artists |
| | 2451 | Authors, journalists and other writers |
| | 2452 | Sculptors, painters and related artists |
| | 2453 | Composers, musicians and singers |
| | 2454 | Choreographers and dancers |

| | | |
|-----|---|--|
| | 2455 | Film, stage and related actors and directors |
| 246 | Religious professionals | |
| | 2460 | Religious professionals |
| 247 | Public service administrative professionals | |
| | 2470 | Public service administrative professionals |

MAJOR GROUP 3: TECHNICIANS AND ASSOCIATE PROFESSIONALS

| | | |
|----|--|---|
| 31 | Physical and engineering science associate professionals | |
| | 311 | Physical and engineering science technicians |
| | | 3111 Chemical and physical science technicians |
| | | 3112 Civil engineering technicians |
| | | 3113 Electrical engineering technicians |
| | | 3114 Electronics and telecommunications engineering technicians |
| | | 3115 Mechanical engineering technicians |
| | | 3116 Chemical engineering technicians |
| | | 3117 Mining and metallurgical technicians |
| | | 3118 Draughtspersons |
| | | 3119 Physical and engineering science technicians not elsewhere classified |
| | 312 | Computer associate professionals |
| | | 3121 Computer assistants |
| | | 3122 Computer equipment operators |
| | | 3123 Industrial robot controllers |
| | 313 | Optical and electronic equipment operators |
| | | 3131 Photographers and image and sound recording equipment operators |
| | | 3132 Broadcasting and telecommunications equipment operators |
| | | 3133 Medical equipment operators |
| | | 3139 Optical and electronic equipment operators not elsewhere classified |
| | 314 | Ship and aircraft controllers and technicians |
| | | 3141 Ships' engineers |
| | | 3142 Ships' deck officers and pilots |
| | | 3143 Aircraft pilots and related associate professionals |
| | | 3144 Air traffic controllers |
| | | 3145 Air traffic safety technicians |
| | 315 | Safety and quality inspectors |
| | | 3151 Building and fire inspectors |
| | | 3152 Safety, health and quality inspectors |
| 32 | Life science and health associate professionals | |
| | 321 | Life science technicians and related associate professional |
| | | 3211 Life science technicians |
| | | 3212 Agronomy and forestry technicians |
| | | 3213 Farming and forestry advisers |
| | 322 | Health associate professionals (except nursing) |
| | | 3221 Medical assistants |
| | | 3222 Hygienists, health and environmental officers |
| | | 3223 Dieticians and nutritionists |
| | | 3224 Optometrists and opticians |
| | | 3225 Dental assistants |
| | | 3226 Physiotherapists and related associate professionals |
| | | 3227 Veterinary assistants |
| | | 3228 Pharmaceutical assistants |
| | | 3229 Health associate professionals (except nursing) not elsewhere classified |
| | 323 | Nursing and midwifery associate professionals |
| | | 3231 Nursing associate professionals |
| | | 3232 Midwifery associate professionals |
| 33 | Teaching associate professionals | |
| | 331 | Primary education teaching associate professionals |
| | | 3310 Primary education teaching associate professionals |
| | 332 | Pre-primary education teaching associate professionals |
| | | 3320 Pre-primary education teaching associate professionals |

| | |
|------|--|
| 333 | Special education teaching associate professionals |
| 3330 | Special education teaching associate professionals |
| 334 | Other teaching associate professionals |
| 3340 | Other teaching associate professionals |
| 34 | Other associate professionals |
| 341 | Finance and sales associate professionals |
| 3411 | Securities and finance dealers and brokers |
| 3412 | Insurance representatives |
| 3413 | Estate agents |
| 3414 | Travel consultants and organisers |
| 3415 | Technical and commercial sales representatives |
| 3416 | Buyers |
| 3417 | Appraisers, valuers and auctioneers |
| 3419 | Finance and sales associate professionals not elsewhere classified |
| 342 | Business services agents and trade brokers |
| 3421 | Trade brokers |
| 3422 | Clearing and forwarding agents |
| 3423 | Employment agents and labour contractors |
| 3429 | Business services agents and trade brokers not elsewhere classified |
| 343 | Administrative associate professionals |
| 3431 | Administrative secretaries and related associate professionals |
| 3432 | Legal and related business associate professionals |
| 3433 | Bookkeepers |
| 3434 | Statistical, mathematical and related associate professionals |
| 344 | Customs, tax and related government associate professionals |
| 3441 | Customs and border inspectors |
| 3442 | Government tax and excise officials |
| 3443 | Government social benefits officials |
| 3444 | Government licensing officials |
| 3449 | Customs, tax and related government associate professionals not elsewhere classified |
| 345 | Police inspectors and detectives |
| 3450 | Police inspectors and detectives |
| 346 | Social work associate professionals |
| 3460 | Social work associate professionals |
| 347 | Artistic, entertainment and sports associate professionals |
| 3471 | Decorators and commercial designers |
| 3472 | Radio, television and other announcers |
| 3473 | Street, night-club and related musicians, singers and dancers |
| 3474 | Clowns, magicians, acrobats and related associate professionals |
| 3475 | Athletes, sports persons and related associate professionals |
| 348 | Religious associate professionals |
| 3480 | Religious associate professionals |

MAJOR GROUP 4: CLERKS

| | |
|------|---|
| 41 | Office clerks |
| 411 | Secretaries and keyboard-operating clerks |
| 4111 | Stenographers and typists |
| 4112 | Word-processor and related operators |
| 4113 | Data entry operators |
| 4114 | Calculating-machine operators |
| 4115 | Secretaries |
| 412 | Numerical clerks |
| 4121 | Accounting and book-keeping clerks |
| 4122 | Statistical and finance clerks |
| 413 | Material-recording and transport clerks |
| 4131 | Stock clerks |
| 4132 | Production clerks |
| 4133 | Transport clerks |

| | |
|------|--|
| 414 | Library, mail and related clerks |
| 4141 | Library and filing clerks |
| 4142 | Mail carriers and sorting clerks |
| 4143 | Coding, proof-reading and related clerks |
| 4144 | Scribes and related workers |
| 419 | Other office clerks |
| 4190 | Other office clerks |
| 42 | Customer services clerks |
| 421 | Cashiers, tellers and related clerks |
| 4211 | Cashiers and ticket clerks |
| 4212 | Tellers and other counter clerks |
| 4213 | Bookmakers and croupiers |
| 4214 | Pawnbrokers and money-lenders |
| 4215 | Debt-Collectors and related workers |
| 422 | Client information clerks |
| 4221 | Travel agency and related clerks |
| 4222 | Receptionists and information clerks |
| 4223 | Telephone switchboard operators |

MAJOR GROUP 5: SERVICE WORKERS AND SHOP AND MARKET SALES WORKERS

| | |
|------|--|
| 51 | Personal and protective services workers |
| 511 | Travel attendants and related workers |
| 5111 | Travel attendants and travel stewards |
| 5112 | Transport conductors |
| 5113 | Travel guides |
| 512 | Housekeeping and restaurant services workers |
| 5121 | Housekeepers and related workers |
| 5122 | Cooks |
| 5123 | Waiters, waitresses and bartenders |
| 513 | Personal care and related workers |
| 5131 | Child-care workers |
| 5132 | Institution-based personal care workers |
| 5133 | Home-based personal care workers |
| 5139 | Personal care and related workers not elsewhere classified |
| 514 | Other personal services workers |
| 5141 | Hairdressers, barbers, beauticians and related workers |
| 5142 | Companions and valets |
| 5143 | Undertakers and embalmers |
| 5149 | Other personal services workers not elsewhere classified |
| 516 | Protective services workers |
| 5161 | Fire-fighters |
| 5162 | Police officers |
| 5163 | Prison guards |
| 5169 | Protective services workers not elsewhere classified |
| 52 | Models, salespersons and demonstrators |
| 521 | Fashion and other models |
| 5210 | Fashion and other models |
| 522 | Shop, stall and market salespersons and demonstrators |
| 5220 | Shop, stall and market salespersons and demonstrators |

MAJOR GROUP 6: SKILLED AGRICULTURAL AND FISHERY WORKERS

| | |
|------|--|
| 61 | Skilled agricultural and fishery workers |
| 611 | Market gardeners and crop growers |
| 6111 | Field crop and vegetable growers |
| 6112 | Gardeners, horticultural and nursery growers |
| 612 | Animal producers and related workers |
| 6121 | Dairy and livestock producers |
| 6122 | Poultry producers |

| | | |
|-----|---------------------------------------|---|
| | 6129 | Animal producers and related workers not elsewhere classified |
| 613 | Crop and animal producers | |
| | 6130 | Crop and animal producers |
| 614 | Forestry and related workers | |
| | 6141 | Forestry workers and loggers |
| | 6142 | Charcoal burners and related workers |
| 615 | Fishery workers, hunters and trappers | |
| | 6151 | Aquatic life cultivation workers |
| | 6152 | Inland and coastal waters fishery workers |
| | 6153 | Deep-sea fishery workers |
| | 6154 | Hunters and trappers |

MAJOR GROUP 7: CRAFT AND RELATED TRADES WORKERS

| | | |
|----|--|--|
| 71 | Extraction and building trades workers | |
| | 711 | Miners, shotfirers, stone cutters and carvers |
| | | 7111 Miners and quarry workers |
| | | 7112 Shotfirers and blasters |
| | | 7113 Stone splitters, cutters and carvers |
| | 712 | Building frame and related trades workers |
| | | 7121 Builders |
| | | 7122 Bricklayers and stonemasons |
| | | 7123 Concrete placers, concrete finishers and related workers |
| | | 7124 Carpenters and joiners |
| | | 7129 Building frame and related trades workers not elsewhere classified |
| | 713 | Building finishers and related trades workers |
| | | 7131 Roofers |
| | | 7132 Floor layers and tile setters |
| | | 7133 Plasterers |
| | | 7134 Insulation workers |
| | | 7135 Glaziers |
| | | 7136 Plumbers and pipe fitters |
| | | 7137 Building and related electricians |
| | | 7139 Building finishers and related trade workers not elsewhere classified |
| | 714 | Painters, building structure cleaners and related trades workers |
| | | 7141 Painters and related workers |
| | | 7143 Building structure cleaners |
| 72 | Metal, machinery and related trades workers | |
| | 721 | Metal moulders, welders, sheet-metal workers, structural-metal preparers, and related trades workers |
| | | 7211 Metal moulders and coremakers |
| | | 7212 Welders and flame cutters |
| | | 7213 Sheet-metal workers |
| | | 7214 Structural-metal preparers and erectors |
| | | 7215 Riggers and cable splicers |
| | | 7216 Underwater workers |
| | 722 | Blacksmiths, tool-makers and related trades workers |
| | | 7221 Blacksmiths, hammer-smiths and forging-press workers |
| | | 7222 Tool-makers and related workers |
| | | 7223 Machine-tool setters and setter-operators |
| | | 7224 Metal wheel-grinders, polishers and tool sharpeners |
| | 723 | Machinery mechanics and fitters |
| | | 7231 Motor vehicle mechanics and fitters |
| | | 7232 Aircraft engine mechanics and fitters |
| | | 7233 Agricultural- or industrial-machinery mechanics and fitters |
| | 724 | Electrical and electronic equipment mechanics and fitters |
| | | 7241 Electrical mechanics fitters and services |
| | | 7242 Electronics mechanics, fitters and services |
| | | 7243 Electronics mechanics and services |
| | | 7244 Telegraph and telephone installers and services |
| | | 7245 Electrical line installers, repairers and cable jointers |
| 73 | Precision, handicraft, craft printing and related trades workers | |

| | |
|--|---|
| 731 | Precision workers in metal and related materials |
| | 7311 Precision-instrument makers and repairers |
| | 7312 Musical-instrument makers and tuners |
| | 7313 Jewellery and precious-metal workers |
| 732 | Potters, glass-makers and related trades workers |
| | 7321 Abrasive wheel formers, potters and related workers |
| | 7322 Glass-makers, cutters, grinders and finishers |
| | 7323 Glass engravers and etchers |
| | 7324 Glass, ceramics and related decorative painters |
| 733 | Handicraft workers in wood, textile, leather and related materials |
| | 7331 Handicraft workers in wood and related materials |
| | 7332 Handicraft workers in textile, leather and related materials |
| 734 | Craft printing and related trades workers |
| | 7341 Compositors, typesetters and related workers |
| | 7342 Stereotypes and electrotypers |
| | 7343 Printing engravers and etchers |
| | 7344 Photographic and related workers |
| | 7345 Bookbinders and related workers |
| | 7346 Silk-screen, block and craft textile printers |
| 74 | Other craft and related trades workers |
| 741 | Food processing and related trades workers |
| | 7411 Butchers, fishmongers and related food preparers |
| | 7412 Bakers, pastry-cooks and confectionery makers |
| | 7413 Dairy-products workers |
| | 7414 Fruit, vegetable and related preservers |
| | 7415 Food and beverage tasters and graders |
| | 7416 Tobacco preparers and tobacco products makers |
| 742 | Wood treaters, cabinet-makers and related trades workers |
| | 7421 Wood treaters |
| | 7422 Cabinetmakers and related workers |
| | 7423 Woodworking machine setters and setter-operators |
| | 7424 Basketry weavers, brush makers and related workers |
| 743 | Textile, garment and related trades workers |
| | 7431 Fibre preparers |
| | 7432 Weavers, knitters and related workers |
| | 7433 Tailors, dressmakers and hatters |
| | 7434 Furriers and related workers |
| | 7435 Textile, leather and related pattern-makers and cutters |
| | 7436 Sewers, embroiderers and related workers |
| | 7437 Upholsterers and related workers |
| 744 | Pelt, leather and shoemaking trades workers |
| | 7441 Pelt dressers, tanners and fellmongers |
| | 7442 Shoe-makers and related workers |
| | |
| MAJOR GROUP 8: PLANT AND MACHINE OPERATORS AND ASSEMBLERS | |
| 81 | Stationary plant and related operators |
| 811 | Mining and mineral-processing-plant operators |
| | 8111 Mining plant operators |
| | 8112 Mineral-ore and stone-processing-plant operators |
| | 8113 Well drillers and borers and related workers |
| 812 | Metal-processing plant operators |
| | 8121 Ore and metal furnace operators |
| | 8122 Metal melters, casters and rolling-mill operators |
| | 8123 Metal heat-treating-plant operators |
| | 8124 Metal drawers and extruders |
| 813 | Glass, ceramics and related plant operators |
| | 8131 Glass and ceramics kiln and related machine operators |
| | 8139 Glass, ceramics and related plant operators not elsewhere classified |
| 814 | Wood-processing- and papermaking-plant operators |
| | 8141 Wood-processing-plant operators |
| | 8142 Paper-pulp plant operators |

| | | |
|-----|------|--|
| | 8143 | Papermaking-plant operators |
| 815 | | Chemical-processing-plant operators |
| | 8151 | Crushing-, grinding- and chemical-mixing-machinery operators |
| | 8152 | Chemical-heat-treating-plant operators |
| | 8153 | Chemical-filtering- and separating-equipment operators |
| | 8154 | Chemical-still and reactor operators (except petroleum and natural gas) |
| | 8155 | Petroleum- and natural-gas-refining-plant operators |
| | 8159 | Chemical-processing-plant operators not elsewhere classified |
| 816 | | Power-production and related plant operators |
| | 8161 | Power-production plant operators |
| | 8162 | Steam-engine and boiler operators |
| | 8163 | Incinerator, water-treatment and related plant operators |
| 817 | | Industrial robot operators |
| | 8170 | Industrial robot operators |
| 82 | | Machine operators and assemblers |
| 821 | | Metal- and mineral-products machine operators |
| | 8211 | Machine-tool operators |
| | 8212 | Cement and other mineral products machine operators |
| 822 | | Chemical-products machine operators |
| | 8221 | Pharmaceutical-and toiletry-products machine operators |
| | 8222 | Ammunition- and explosive-products machine operators |
| | 8223 | Metal finishing-, plating- and coating-machine operators |
| | 8224 | Photographic-products machine operators |
| | 8229 | Chemical-products machine operators not elsewhere classified |
| 823 | | Rubber- and plastic-products machine operators |
| | 8231 | Rubber-products machine operators |
| | 8232 | Plastic-products machine operators |
| 824 | | Wood-products machine operators |
| | 8240 | Wood-products machine operators |
| 825 | | Printing-, binding- and paper-products machine operators |
| | 8251 | Printing-machine operators |
| | 8252 | Book-binding-machine operators |
| | 8253 | Paper-products machine operators |
| 826 | | Textile-, fur- and leather-products machine operators |
| | 8261 | Fibre-preparing-, spinning- and winding-machine operators |
| | 8262 | Weaving- and knitting-machine operators |
| | 8263 | Sewing-machine operators |
| | 8264 | Bleaching-, dyeing- and cleaning-machine operators |
| | 8265 | Fur- and leather-preparing-machine operators |
| | 8266 | Shoemaking- and related machine operators |
| | 8269 | Textile-, fur- and leather-products machine operators not elsewhere classified |
| 827 | | Food and related products machine operators |
| | 8271 | Meat- and fish-processing-machine operators |
| | 8272 | Dairy-products machine operators |
| | 8273 | Grain- and spice-milling-machine operators |
| | 8274 | Baked-goods, cereal- and chocolate-products machine operators |
| | 8275 | Fruit-, vegetable- and nut-processing-machine operators |
| | 8276 | Sugar production machine operators |
| | 8277 | Tea-, coffee- and cocoa-processing-machine operators |
| | 8278 | Brewers, wine and other beverage machine operators |
| | 8279 | Tobacco production machine operators |
| 828 | | Assemblers |
| | 8281 | Mechanical-machinery assemblers |
| | 8282 | Electrical-equipment assemblers |
| | 8283 | Electronic-equipment assemblers |
| | 8284 | Metal-, rubber- and plastic-products assemblers |
| | 8285 | Wood and related products assemblers |
| | 8286 | Paperboard, textile and related products assemblers |
| | 8287 | Composite products assemblers |
| 829 | | Other machine operators not elsewhere classified |

| | | |
|----|------|--|
| | 8290 | Other machine operators not elsewhere classified |
| 83 | | Drivers and mobile plant operators |
| | 831 | Locomotive engine drivers and related workers |
| | 8311 | Locomotive engine drivers |
| | 8312 | Railway brakemen, signallers and shunters |
| | 832 | Motor vehicle drivers |
| | 8321 | Motorcycle drivers |
| | 8322 | Car, taxi and van drivers |
| | 8323 | Bus and tram drivers |
| | 8324 | Heavy truck and lorry drivers |
| | 833 | Agricultural and other mobile plant operators |
| | 8331 | Motorised farm and forestry plant operators |
| | 8332 | Earth-moving and related plant operators |
| | 8333 | Crane, hoist and related plant operators |
| | 8334 | Lifting-truck operators |
| | 834 | Ships' deck crews and related workers |
| | 8340 | Ships' deck crews and related workers |

MAJOR GROUP 9: ELEMENTARY OCCUPATIONS

| | | |
|----|------|--|
| 91 | | Sales and services elementary occupations |
| | 911 | Street vendors and related workers |
| | 9111 | Street vendors |
| | 9113 | Door-to-door and telephone salespersons |
| | 912 | Shoe cleaning and other street services elementary occupations |
| | 9120 | Shoe cleaning and other street services elementary occupations |
| | 913 | Domestic and related helpers, cleaners and launderers |
| | 9131 | Domestic helpers and cleaners |
| | 9132 | Helpers and cleaners in offices, hotels and other establishments |
| | 9133 | Hand-launderers and pressers |
| | 914 | Building caretakers, window and related cleaners |
| | 9141 | Building caretakers |
| | 9142 | Vehicle, window and related cleaners |
| | 915 | Messengers, porters, doorkeepers and related workers |
| | 9151 | Messengers, package and luggage porters and deliverers |
| | 9152 | Doorkeepers, watchpersons and related workers |
| | 9153 | Vending-machine money Collectors, meter readers and related workers |
| | 916 | Garbage Collectors and related labourers |
| | 9161 | Garbage Collectors |
| | 9162 | Sweepers and related labourers |
| 92 | | Agricultural, fishery and related labourers |
| | 921 | Agricultural, fishery and related labourers |
| | 9211 | Farm-hands and labourers |
| | 9212 | Forestry labourers |
| | 9213 | Fishery, hunting and trapping labourers |
| 93 | | Labourers in mining, construction, manufacturing and transport |
| | 931 | Mining and construction labourers |
| | 9311 | Mining and quarrying labourers |
| | 9312 | Construction and maintenance labourers: roads, dams, and similar constructions |
| | 9313 | Building construction labourers |
| | 932 | Manufacturing labourers |
| | 9320 | Manufacturing labourers |
| | 933 | Transport labourers and freight handlers |
| | 9330 | Transport labourers and freight handlers |

MAJOR GROUP 0: ARMED FORCES

| | | | |
|----|--------------|--------------|--------------|
| 01 | Armed forces | | |
| | 010 | Armed forces | |
| | | 0100 | Armed forces |

Annex IV - ISO country classification in the LFS from 2009 onwards

These codes apply to the variables: nationality, country of birth, country of place of work and country of residence one year before survey.

| EUROPEAN UNION | | OTHER EUROPEAN COUNTRIES | | 6 OTHER AFRICA | |
|-----------------------|-----------------|---------------------------------|-----------------------|-----------------------|---|
| BE | Belgium | AD | Andorra | AO | Angola |
| CZ | Czech Republic | AL | Albania | BF | Burkina Faso |
| DK | Denmark | BA | Bosnia Herzegovina | BI | Burundi |
| DE | Germany | BY | Belarus | BJ | Benin |
| EE | Estonia | MD | Republic of Moldova | BW | Botswana |
| GR | Greece | MK | FYRMacedonia | CD | Republic Democratic of Congo Central African Republic |
| ES | Spain | RU | Russian Federation | CF | Congo |
| FR | France | SM | San Marino | CG | Ivory Coast |
| IE | Ireland | UA | Ukraine | CI | Cameroon |
| IT | Italy | VA | Vatican City | CM | Cape Verde |
| CY | Cyprus | XK | Kosovo | CV | Djibouti |
| LV | Latvia | ME | Montenegro | DJ | Eritrea |
| LT | Lithuania | RS | Serbia | ER | |
| LU | Luxembourg | CS | *Serbia - Montenegro | ET | Ethiopia |
| HU | Hungary | | | GA | Gabon |
| MT | Malta | | 5 NORTH AFRICA | GH | Ghana |
| NL | Netherlands | DZ | Algeria | GM | Gambia |
| AT | Austria | EG | Egypt | GN | Guinea |
| PL | Poland | LY | Libya | GQ | Equatorial Guinea |
| PT | Portugal | MA | Morocco | GW | Guinea-Bissau |
| SI | Slovenia | TN | Tunisia | KE | Kenya |
| SK | Slovak Republic | MR | Mauritania | LR | Liberia |
| FI | Finland | MU | Mauritius | LS | Lesotho |
| SE | Sweden | MW | Malawi | MG | Madagascar |
| UK | United Kingdom | MZ | Mozambique | ML | Mali |
| | | NA | Namibia | | |
| | | NE | Niger | | 7 NORTH AMERICA |
| | | NG | Nigeria | BM | Bermuda |
| | | RW | Rwanda | CA | Canada |
| | | SC | Seychelles | GL | Greenland |
| | | SD | Sudan | PM | Saint Pierre and Miquelon |
| | | SL | Sierra Leone | US | United States of America |
| | | SN | Senegal | | |
| | | SO | Somalia | | |
| | | ST | Sao Tome and Principe | | |
| | | SZ | Swaziland | | |
| | | TD | Chad | | |
| | | TG | Togo | | |
| | | TZ | Tanzania | | |
| | | UG | Uganda | | |
| | | ZA | South Africa | | |
| | | ZM | Zambia | | |
| | | ZW | Zimbabwe | | |

* to be used temporarily

| | | | | | |
|----|--|----|---|-------|--|
| | 8 CENTRAL AMERICA AND CARRIBEAN | | 10 EAST ASIA | IN | India |
| AG | Antigua and Barbuda | CN | China | KH | Cambodia |
| AN | Netherlands Antilles | JP | Japan | KP | Dem. People's Republic of Korea (North) |
| BB | Barbados | TW | Taiwan | KR | Republic of Korea (South) |
| BS | Bahamas | | | LA | Laos |
| | | | NEAR AND MIDDLE EAST | LK | Sri Lanka |
| BZ | Belize | AE | United Arab Emirates | MM | Myanmar |
| CR | Costa Rica | AM | Armenia | MN | Mongolia |
| CU | Cuba | AZ | Azerbaijan | MV | Maldives |
| DO | Dominican Republic | BH | Bahrein | MY | Malaysia |
| DM | Dominica | GE | Georgia | NP | Nepal |
| GD | Grenada | IL | Israel | PH | Philippines |
| GT | Guatemala | IQ | Iraq | PK | Pakistan |
| HN | Honduras | IR | Iran | SG | Singapore |
| HT | Haiti | JO | Jordan | TH | Thailand |
| JM | Jamaica | KG | Kyrgyzstan | TL | East Timor |
| MX | Mexico | KW | Kuwait | VN | Vietnam |
| NI | Nicaragua | KZ | Kazakhstan | | |
| PA | Panama | | | | |
| | | | | | 13 AUSTRALIA, OCEANIA AND OTHER TERRITORIES |
| PR | Puerto Rico | LB | Lebanon | AU | Australia |
| SV | El Salvador | OM | Oman | FJ | Fiji |
| TT | Trinidad and Tobago | PS | Palestine | FM | Micronesia |
| | | QA | Qatar | | |
| | 9 SOUTH AMERICA | | Saudi Arabia | NC | New Caledonia |
| AR | Argentina | SA | Arabia | NZ | New Zealand |
| BO | Bolivia | SY | Syria | PF | French Polynesia |
| BR | Brazil | TJ | Tajikistan | PG | Papua New Guinea |
| CL | Chile | TM | Turkmenistan | SB | Solomon Islands |
| CO | Colombia | UZ | Uzbeksitan | VU | Vanuatu |
| EC | Ecuador | YE | Yemen | | |
| | | | 12 SOUTH AND SOUTH EAST ASIA | | 14 OTHER + STATELESS |
| GY | Guyana | | Afghanista n | | |
| PE | Peru | AF | n | | |
| PY | Paraguay | BD | Bangladesh | Blank | No answer |
| SR | Surinam | BN | Brunei | | |
| UY | Uruguay | BT | Bhutan | | |
| VE | Venezuela | ID | Indonesia | | |