

CONTENTS

SECTION 1: INTRODUCTION TO LFS USER GUIDE VOLUME 9 (EUROSTAT)	
SECTION 2: EUROSTAT – AN INTRODUCTION	
EuroStat Mission	2
EuroStat databases	3
EuroStat Publications	4
Organisation of EuroStat	5
A brief history of EuroStat	5
EuroStat Address	6
SECTION 3: LABOUR FORCE SURVEYS IN THE EUROPEAN UNION	
The purpose of labour force surveys	7
The history of labour force surveys	9
The development of the EU Labour Force Survey	9
The organisation of the EU Labour Force Survey	11
Data Collection and diffusion of results	11
SECTION 4: TECHNICAL FEATURES OF THE EU LABOUR FORCE SURVEY	
Field of the survey/reference period/units of measurement	13
Reliability of the results/comparability of results between countries	14
Comparability of results between successive surveys	15
Basic concepts and definitions	16
SECTION 5a: COUNCIL REGULATION 577/98 OF THE EUROPEAN UNION	
Article 1 – Frequency of the survey	19
Article 2 – Units and scope of the survey, observation methods	20
Article 3 – Representativeness of the sample	21
Article 4 – Survey characteristics	21
Article 5 – Conduct of the survey	24
Article 6 – Transmission of results	24
Article 7 – Reports	25
Article 8 – Procedure	25
SECTION 5b: COUNCIL REGULATION 2257/2003 OF THE EUROPEAN UNION	26
SECTION 5c: COUNCIL REGULATION 430/2005 OF THE EUROPEAN UNION	28
SECTION 5d: COMMISSION REGULATION 377/2008 OF THE EUROPEAN UNION	30
SECTION 6: LABOUR FORCE SURVEY - DATA CODIFICATION 2009	33
SECTION 7: EXPLANATORY NOTES TO THE LFS LIST OF VARIABLES	49
SECTION 8: EUROSTAT AD HOC MODULES	90
SECTION 9: EUROSTAT DERIVED VARIABLE FLOWCHARTS	110
ANNEX 1: REGIONAL CODES USED IN THE EU LFS FROM 2007	302
ANNEX 2: STATISTICAL CLASSIFICATION OF ECONOMIC ACTIVITIES AT 2 AND 3 DIGITS	308
ANNEX 3: INTERNATIONAL STANDARD CLASSIFICATION OF OCCUPATIONS 2, 3 AND 4 DIGITS (ISCO-88 (COM))	317
ANNEX 4: ISO COUNTRY CLASSIFICATION IN THE LFS FROM 2009 ONWARDS	327

SECTION 1: INTRODUCTION TO LFS USER GUIDE VOLUME 9 (EUROSTAT)

This volume of the LFS User Guide has been compiled in response to the increasing interest in the LFS data used by EuroStat, and in EuroStat itself. Most of the contents have been taken from EuroStat's internet web site and various publications such as *The European Union Labour Force Survey – Methods and Definitions*.

The structure of this volume is as follows.

Section 2 provides a summary of EuroStat's objective, coverage, and structure. Section 3 describes the purpose and development of an EU-wide Labour Force Survey – essentially, the pulling together of the LFS conducted in each Member State. Section 4 provides some technical detail of the EU LFS.

The latest EU LFS Regulation (No. 377/2008) implements Council Regulation No. 577/98 on the organisation of a labour force sample survey in the Community concerning the codification to be used for data transmission from 2009 onwards and the use of a sub-sample for the collection of data on structural variables. The text of these regulations is shown in Section 5.

Sections 6 and 7 compliment the fifth section. Essentially, whilst the Regulations outline the broad areas for which data are required, section 6 provide the associated data codification. This describes how the LFS database provided to EuroStat is structured in terms of database columns and the values which can be included in each column. Section 7 has the explanatory notes relating to each variable. These notes are intended to help Member States collect data which are sufficiently comparable for EuroStat's purposes. They are also useful to data analysts to see exactly what has been collected.

Each year EuroStat includes a number of variables that provide information on aspects of the labour market but which do not form part of the standard questionnaire. This set of variables, constitute an "*ad hoc* module". Section 8 explains this in more detail.

Finally, section 9 provides flowcharts which show how each of the variables supplied to EuroStat are derived from the questions actually asked in the UK LFS.

SECTION 2: EUROSTAT – AN INTRODUCTION

EuroStat - the "Statistical Office of the European Communities" was established in 1953. Its mission is *to provide the European Union with a high-quality statistical information service, by using uniform rules to collect all statistical data from the National Statistical Institutes of each of the Member States of the European Union.*

Once these data have been collected in the required form, they are consolidated and then harmonised to take into account each country's specific characteristics, so that they can be used either globally or comparatively.

This process of harmonising statistical data also extends to all the European Union's partners: members of the European Economic Area (EEA), including Switzerland, and, in a number of fields essential to an understanding of Europe's position in the world, the USA and Japan.

As with any service provider, EuroStat's prime aim is to answer requests for specific statistical information. As it is the Statistical Office of the European Communities, these requests most frequently come from the European Commission.

They are followed by 3 essential steps:

1. **Validation of the statistical research itself**

Together with the appropriate Directorates-General plus experts' reports and the recommendations of international organisations (e.g. UN, OECD), EuroStat prepares a statistical programme which is submitted to the European Commission's "Statistical Programme Committee". EuroStat then works with the different committees, expert groups and working groups concerned to achieve a broad consensus on the proposed new statistics.

2. **Data Collection**

EuroStat collects its data from the National Statistical Institutes of the countries concerned. All data are checked by EuroStat, compiled in the required form and, where applicable, harmonised with European Statistical System standards.

3. **Legal base**

When new statistics are adopted in the European Union, or when there is a need to harmonise statistics from Member States, the decision is taken by a Council legal act which may take one of the following 3 forms:

- regulation
- directive
- recommendation

In 2005, EuroStat had around 800 employees, including registered national experts on temporary assignment and permanent European civil servants. They are all committed to the same fundamental mission: to provide the European Union with a high-quality harmonised statistical information service, offering the best possible guarantees of completeness and reliability.

A special Committee of the Commission grants EuroStat a budget for the implementation of the statistical programme. In 2003, EuroStat had a budget of around 56 million Euros.

EuroStat Data

Statistical data that are collected, harmonised and referenced by EuroStat are disseminated as

electronic products and computerised media, printed publications or databases. They are regularly updated and are divided into 10 major statistical themes:

- Key indicators on EU policy
- General and regional statistics
- Economy and finance
- Population and social conditions
- Industry, trade and services
- Agriculture, forestry and fisheries
- External trade
- Transport
- Environment and energy
- Science and technology

EuroStat databases

EuroStat offers a thematic selection of databases that are constantly added to, updated and harmonised. They include:

- Ramon, which houses all the past and present metadata such as classifications, concepts and definitions
- New Cronos, which contains some 70 million items of statistical data on Member States of the European Union, and, in many cases, on their main non-European economic partners
- Comext, "external trade database": for data on imports and exports by EU countries in both value and volume terms
- REGIO, containing all Member States' socio-economic data, with regional breakdown
- Eurofarm, statistical data based on the Union surveys on the structure of agricultural holdings
- GISCO, database that combines statistical information and geo-referenced data, allowing each item of data to be related to its environment
- In line with its mission as a provider of statistical information, EuroStat offers users a DataShop service. The EuroStat Data Shops network is open to the public for any information on EuroStat databases, their respective data or access possibilities, as well as any specific statistical search.

EuroStat Publications

A lot of publications published by EuroStat contain Labour Force Survey data, *Employment in Europe* being the main one (170 pages of data analyses almost exclusively using LFS data).

Others include:-

- *Employment Outlook*
- *Europe in Figures*
- *Social Portrait of Europe*
- *EuroStat Yearbook*
- *Labour Force Survey in the EU, Candidate and EFTA countries*
- *Statistics in Focus*

Ordering these and other EuroStat publications can be done via EuroStat's information and distribution network:

- *The EuroStat Data Shops Network* – aimed at the broader public, these shops answer any specific request for information, publication or statistical research.
- *Private Hosts* – they disseminate entire EuroStat databases or part of them.
- *The National Statistics Institutes* – these provide references for national publications and main EuroStat data
- *Sales Offices* – there are about 45 of these that stock all EU publications.
- *Offices and Delegations* – these are the commission's official information centres. They provide the public with statistical information on current EU developments.
- *European Documentation Centres* – there are over 750 of these centres and libraries which officially house most EuroStat publications.
- *Euro-info-centres* – these were created by the European Commission for helping small and medium sized enterprises, there are over 200 of them.

Organisation of EuroStat

EuroStat is headed by a Director-General. Under him are seven Directors responsible for different sectors of EuroStat activities:

- Resources
- Statistical methods and tools; dissemination
- National and European accounts
- Economic and regional statistics
- Agriculture and environment statistics; statistical cooperation
- Social statistics and information society
- Business statistics

A Brief History of EuroStat

Since it was founded in 1953, EuroStat has pursued its primary role of developing and setting up a reliable, complete and harmonised source of European statistical information. The following are important milestones:

1953	Foundation of the Statistics Division of the High Authority of the Coal and Steel Community.
1958	Foundation of the Statistics Division of the European Communities.
1959	Adoption of the present title "Statistical Office of the European Communities". Staff: 58. First labour costs survey. First publication of "Agricultural statistics".
1960	First Community labour force survey.
1961	First agricultural supply balance sheet compiled on a Community basis.
1962	First overall energy balance sheets.
1965	Publication of the first national input-output tables (1959).
1966	First Community farm structure survey.
1968	First regular labour force survey in the Community.
1970	Publication of the European System of Integrated Economic Accounts (ESA). General industrial classification of economic activities within the European Communities (NACE).
1972	Council Regulation on the Nimex nomenclature.
1974	First domain installed in the Cronos databank.
1976	First use of purchasing power parities in connection with the ESA. First forecast of agricultural incomes using the Sectoral Income Index.
1978	The Member States compile and supply statistics according to the Nimex.
1981	Cronos accessible on-line on the Euronet network via commercial hosts. First publication of raw materials balance sheets. Publication of the "Handbook of Economic Accounts for Agriculture".
1982	On-line access to the Comext external trade databank on the Euronet network.
1987	First publication of the foreign trade volume indices.
1988	Introduction of the Harmonised System (HS) for the Collection and processing of external trade data according to the combined nomenclature (CN). Communication to the Commission on Community policy and statistical information.
1989	Adoption of the Directive on the compilation of GNP. Adoption by the Council of the 1989-1992 Statistical Programme as an instrument for

	implementing statistical information policy.
1990	As a result of German unification on 3 October 1990, the sphere of responsibility of the EC and hence of EuroStat increases.
1991	EuroStat's role extended as a result of the agreement on the establishment of the EEA (European Economic Area) in October 1991. In December, adoption of the Treaty on European Union by the European Council in Maastricht ushers in a new phase for EuroStat. All statistical data on EC external trade and trade between Member States (Comext) published on CD-ROM.
1992	Adoption of the 1993-1997 Statistical Programme, which includes the EFTA countries.
1993	Start of the single market in 1993 extends EuroStat's activities (e.g. Intrastat). Publication of the new CD-ROM: general socio-economic information. EuroStat starts issuing regular news releases on its statistics and achieves widespread publicity in the European news media.
1994	First European household panel held, analysing income, employment, poverty, social exclusion, households, health etc
1995	The entry of Austria, Sweden and Finland into the European Union further extends EuroStat's role.
1997	Statistics added for the first time to the Treaty of Amsterdam and the Statistical Law approved by the Council. Harmonised Indices of Consumer Prices published for the first time - designed for EMU convergence criteria.
1998	The 11 countries in at the start of EMU (EUR-11) announced and EuroStat issues the first indicators specific to the EMU area. Statistical programme 1998-2002 adopted.
1999	Start of EMU, 1 st January 2001 Greece joins to euro-zone,
2002	Start of the euro, 1 st January. Statistical programme 2003-2007 adopted.
2002	Announced at the Copenhagen Summit in December 2002 that Cyprus, the Czech Republic, Estonia, Hungary, Latvia, Lithuania, Malta, Poland, Slovakia and Slovenia would join the European Union on 1 May 2004, and other countries should follow in 2007.
2004	Start of free of charge dissemination of all statistical data except microdata for research purposes.
2005	Commission Recommendation on the independence, integrity and accountability of the national and Community statistical authorities (European Statistics Code of Practice)
2005	Start of a three year peer review exercise across the European Statistical System to check the compliance with the Code of Practice.
2007	The currently valid 5 years Statistical Programme.
2008-2012	was adopted 2009 New European Regulation governing the statistical cooperation in the European Union was adopted.

EuroStat Address

Statistical Office of the European Communities
Batiment Joseph Bech
5 Rue Alphonse Weicker
L-2721 Luxembourg

Telephone	(+352) 4301-34567	Fax	(+352) 4301-32594
E-mail	info.desk@EuroStat.cec.eu.int		
Web site	http://europa.eu.int/EuroStat.html		

SECTION 3: LABOUR FORCE SURVEYS IN THE EUROPEAN UNION

The purpose of labour force surveys

A labour force survey is a survey directed to households designed to obtain information on the labour market and related issues by means of personal interviews. As it would clearly involve considerable expense to include all households (as in population censuses) labour force surveys are usually confined to a sample of households, the actual size of which depends primarily on the level of detail required in the survey estimates.

There are a number of advantages in using an approach of this kind in collecting labour market information. In the first place it affords the opportunity to obtain information on relevant labour market aspects across all sectors of the economy in a consistent manner. It also facilitates the interpretation of the information in a wider population setting, since the information collected need not necessarily be confined to persons in the labour force (i.e. those employed or unemployed), but can involve all other persons in the households covered. In current labour market circumstances this is an important additional dimension as analysis is increasingly concerned with those on the peripheries of the labour market.

In recent decades the borderline between the labour force and what is termed the *economically inactive* population has become increasingly blurred, due to the increasing incidence of part-time and temporary work and the ease with which large numbers of persons (particularly women and young persons in the final stages of their education) repeatedly enter or leave the labour force. Furthermore, the emergence of mass unemployment and long-term unemployment resulted in a great many individuals becoming “marginalised” in the sense that they tend to lose tangible contact with the core labour market. The wider coverage associated with labour force surveys also allow the possibility of assessing labour market effects in a household or family context. This is important if, for example, one wants to measure the extent to which persons other than those directly involved (e.g. spouses, other dependants, etc.) are affected by the circumstances of unemployment.

Another advantage of a labour force survey is that it affords the opportunity to define certain labour market characteristics not normally available from other statistical sources. Thus, for example, it is possible to identify the degree of employment engaged in by an individual in terms of the hours worked, or attempt to conceptualise unemployment in terms of aspects such as job search and availability for work. This is important because of the advantages it confers in being able to define certain labour market entities in a more meaningful way. Additionally, because the definitions used to measure these entities are the same for each country, comparability between Member States is guaranteed for certain estimates. This aspect is clearly of considerable importance in the context of the European Union.

There are however some limitations which apply to labour force surveys. Cost considerations place a constraint on the overall household sample size and the resultant sampling variability limits the level of detail that can reasonably be shown. Thus, for example, while the labour force survey can be used to compile estimates of employment across economic sectors, it cannot be expected to yield reliable figures at a detailed level of regional desegregation, nor for individual small industrial or commercial sub-sectors. The sampling base on which such estimates would depend would be too small, and the degree of variability correspondingly high. For the same reason, there is also a limit to what can be

achieved with labour force surveys in monitoring trends over time (in employment and unemployment, for example), especially if the movements involved are relatively small.

It is appropriate at this point to refer briefly to other sources of statistical information so that the position of the labour force survey in an overall statistical perspective can be more clearly understood. The other principal sources of labour market information are:-

- (a) surveys of enterprises and
- (b) administrative records.

The former source clearly has the potential for providing detailed estimates of employment for individual sectors (and in fact this is done in many countries). However, such a source is clearly restricted to a consideration of those with jobs and cannot provide any information on the unemployed, nor other persons outside the labour force but who may have an attachment to it. Such surveys can, however, be used to obtain information, not only in relation to employment, but also to output, earnings and hours worked. The simultaneous collection of consistent data on employment and output makes it possible to compile indicators of productivity. Indeed, the derivation of output-type information is usually the main purpose of enterprise-based surveys. Many countries, for example, carry out detailed quarterly or monthly surveys of the industrial sector which provide consistent information on output, earnings, employment and other related aspects.

Administrative records, such as social insurance records or population registers as widely used in Denmark, Sweden and Finland, can also be used to provide indicators of the levels of employment and unemployment. A prerequisite, however, is that the administrative arrangements should specifically cater for the extraction of the relevant statistics. While this source involves relatively less expense than information derived from either enterprise or household surveys, it suffers from a significant disadvantage in that the underlying systems are based on social welfare or other administrative provisions which may not necessarily accord with the accepted conventions for defining employment and unemployment. Furthermore, if these arrangements are changed (and experience indicates that they frequently are), discontinuity invariably arises in the data. A disadvantage of even greater relevance in an international or EU context is the fact that the social insurance systems in question vary greatly from country to country, both in terms of their design and in the manner of their implementation. This renders the derived information virtually useless in the context of making comparisons between countries, especially in absolute terms. Such sources can, however, provide a reasonable basis for monitoring short-term (i.e. monthly, quarterly, etc.) trends, the most notable in this regard being the various national series on the registered unemployed.

To summarise, therefore, the principal advantages associated with labour force surveys relate to:

- (1) the opportunity of obtaining comprehensive information (at less cost than a census) across the entire economy, which can be assessed in a global setting embracing society as a whole;
- (2) the inherent flexibility of such surveys, which makes it possible to define or conceptualise not only employment and unemployment, but also the circumstances surrounding other groups outside or on the margins of the labour force.

This latter feature (i.e. the facility to conceptualise or define) has assumed greater importance in recent years because of the manner in which labour markets and society have generally evolved, and in view of the growing need to view labour market phenomena in an international context. It must be recognised, however, that the sampling aspect associated with labour force surveys places a limitation on the level of detail possible when analysing the results.

The history of labour force surveys

The notion of obtaining information on the work force by means of household-based surveys is not in any sense new. Questions on the concept of possessing a *gainful occupation* were introduced in censuses of population in some countries during the latter half of the last century. However, at that stage no questions were asked in regard to what is termed a person's economic status, i.e. whether at work, unemployed or economically inactive. Indeed, at that stage such a notion was hardly even conceived. However, the advancing trend of industrialisation and the resultant restructuring of society created a need for new, approaches, and for more sophistication in measuring labour market phenomena. The situation became particularly urgent with the advent of mass unemployment in the 1930's following the Great Depression. Whatever the uncertainties that may have previously existed regarding the need to conceptualise or measure unemployment were dispelled by the sheer fact of millions in a state of enforced idleness. There was now a clear need to have regular information on the level and trend of employment and unemployment. The first labour force survey was introduced in the United States in 1940 (on a monthly basis) with a new conceptual framework designed to provide information on relevant labour market characteristics.

The movement towards the use of labour force surveys was somewhat slower in Europe. While the intervention of the war years contributed to this, it was also due to the existence of alternative sources of information which provided at least a partial insight into aspects of the labour force. Virtually all Western European countries maintained comprehensive unemployment registers for the purpose of dispensing unemployment compensation which, despite their disadvantages, provided a rudimentary basis for monitoring unemployment trends. However, in time, as the need to take a more global view of the labour market became apparent, different European countries began to initiate labour force surveys. The first European country to carry out a labour force survey was France in 1950. Further such surveys were conducted in France throughout the subsequent decade and these evolved into a regular consistent series in the early 1960s. After an extended period of preparation, the Federal Republic of Germany initiated an annual series of labour force surveys in 1957 (the Mikrozensus). Sweden conducted its first labour force survey in 1959 and, after further experimentation, initiated a quarterly series in 1963.

The development of the EU Labour Force Survey

More than forty years have passed since the first attempt was made in 1960 to collect comparable data on employment and unemployment from the six original Member States of the then European Community by means of a labour force survey. Since that date, the number of Member States has risen to twenty-five and the character of the European labour market has been transformed by the changes which have taken place, for example in employment rates, in the allocation of working-time, and in the distribution of employment across the various sectors of the economy.

Throughout this period, the institutions of the European Union have included the issues of employment and unemployment among their highest priorities. In consequence, the demand

for accurate and comparable information on the labour market has progressively become more urgent.

In this context, the role of the EU Labour Force Survey (LFS) has gained steadily in importance and is now universally recognised as an indispensable tool for observing labour market developments and for taking the appropriate policy measures. The LFS is the only source of information in these areas to provide data, which is truly comparable in the sense of being independent of the national administrative and legislative framework. Among the statistical instruments available in the European Union, the LFS is unique for the sample-size it covers, for the length of the time-series which it offers, and for the unrivalled picture it can provide of economic and social developments from the very earliest days of the European Community right up to the present day.

No.	From	To	Main developments
1.	1960		The first LFS was organised in the six original member states in 1960 by EuroStat. The countries are Belgium, Germany, France, Italy, Luxembourg and Netherlands.
2.	1968	1971	Annual surveys introduced. Not all six member states were covered in each year.
3.	1973	1981	Biennial surveys initiated due to EU enlargement. The UK was the only one of the three new members to join in 1973 but Ireland and Denmark also took part in 1975, 1977, 1979 and 1981.
4.	1983	1991	Annual surveys on the basis of a revised set of concepts designed to guarantee an improved degree of comparability between the member states. The concepts and definitions used were those adopted by the 13th International Conference of Labour Statisticians of 1982. The methodological basis is described in the publication <i>LFS - Methods and Definitions 1988</i> .
5.	1992	1997	In 1992, a number of changes were introduced with the aim of improving the quality of the data and their reliability at national and regional level; Council Regulation (EEC) 3711/1991 specified the contents and reliability criteria for the survey, to be conducted annually from 1992. The methodological basis and the content of the series of surveys between 1992 and 1997 are described in the publication <i>LFS - Methods and Definitions - 1992 series</i> .
6.	1995	2000	LFS covers all 15 member states.
7.	1998	2000	In 1998 the Council regulation n° 577/1998 was adopted and replaced the previous one to take into account new statistical requirements. The methodological basis and the contents of this new series of surveys are described in the publication <i>LFS - Methods and Definitions -1998</i> .
8.	2001	2005	In 2000 the regulation n° 1575/2000 was adopted concerning the codification to be used for data transmission from the year 2001 onwards. The 2001 codification can be found at http://forum.europa.eu.int/irc/dsis/employment/info/data/eu_lfs/lfs_regulations.htm
9.	2000		LFS covers all 25 member states.
10.	2002		Regulation 1991/2002 of the European Parliament and of the Council of 8 October 2002 amending Council Regulation (EC) No 577/98 on the organisation of a labour force sample survey in the Community introduced a deadline (end of 2002) for the period of transition given to the Member States to introduce a continuous quarterly survey (derogation periods for Cyprus until the end of 2004 and Germany until the end of 2005).
11	2005		Regulation No. 430/2005 amended 577/98 on the organisation of a labour force sample survey in the Community concerning the codification to be used for data transmission from 2006 onwards and the use of a sub sample for the collection of data on structural variables.
12	2008		Regulation No. 377/2008 amended 577/98 on the organisation of a labour force sample survey in the Community concerning the codification to be used for data transmission from 2009 onwards and the use of a sub sample for the collection of data on structural variables.

The Organisation of the EU Labour Force Survey

The earliest Community Labour Force Surveys were not covered by legislation, but, from 1973 onwards, a Regulation was passed by the Council of Ministers governing the operation of the survey. Each Regulation applied only to a single year's survey, until the surveys of 1990 and 1991 were included in one Regulation (Council Regulation (EEC) No. 3044/89). In 1998 a new Regulation was adopted (Council Regulation (EEC) No. 577/98).

EU regulations stipulate the agreements reached by the Member States and EuroStat on the implementation of the survey. The technical aspects of the survey are discussed by EuroStat and representatives of the respective national statistical offices and employment ministries, meeting regularly (between one and three times a year) at the Labour Market Statistics Working Group held in Luxembourg. This Working Group determines the content of the survey, the EU list of questions and the common coding of individual replies, as well as the principal definitions to be applied for the analyses of the results.

The national statistical institutes are responsible for selecting the sample, preparing the questionnaires, conducting the direct interviews among households, and forwarding the results to EuroStat in accordance with the common coding scheme. EuroStat devises the programme for analysing the results and is responsible for processing and disseminating the information sent by the national statistical institutes.

The questionnaires are drawn up by each Member State in the national language or languages, taking into account the stipulations made in the Regulation. For every survey characteristic listed in the Regulation, a question or series of questions exists in each questionnaire to permit this information to be supplied to EuroStat. Otherwise the information is imputed from other sources such as population registers. The questionnaires may also contain other questions which do not relate to the list of characteristics in the Regulation, but rather reflect an interest in the topic concerned at national level. Based on the sample design the figures obtained from the sample survey are expanded to population levels, usually on the basis of weighting factors derived from the most recent census of population, suitably adjusted to take account of recent changes which may have occurred since that census.

Data Collection and diffusion of results

As soon as each Member State has completed its data collection and verification, the part pertaining to the EU Labour Force Survey is, if necessary, transcoded to EuroStat requirements and transmitted by magnetic support. EuroStat then checks the data for errors according to its own programme of controls. When the data are considered to be error-free they are converted into a SAS database, which can be easily accessed to produce reports. For reasons of confidentiality this database may only be accessed by accredited EuroStat personnel.

Most Member States produce regular publications setting out the results of their national surveys. The yearly report at EU level, which, as mentioned, is the responsibility of EuroStat, contains five main sections covering population and activity, employment, working time, unemployment and search for work, and households. Some specific organisational and methodological notes are included in this publication, but, in the interests of rapid diffusion of the results, an attempt is made to analyse the data. From 1994 onwards a selection of graphs has been included in order to improve the presentation of the results.

Detailed studies of labour market developments in the European Union may be found in the annual Commission Report Employment in Europe and, in the wider context of the highly-developed countries, in the OECD's Employment Outlook. Data are supplied from the EU LFS database for these publications as well as for a plethora of other studies and reports at national and international level.

Within EuroStat, the richness of the EU Labour Force Survey, including its household dimension, causes it to be frequently used for general publications such as *Europe in Figures* and the *Social Portrait of Europe*. The EU LFS database is also occasionally used to provide data for the publication of Rapid Reports by other services of EuroStat. Among more specialised applications is the use of the database to produce comparable annual estimates of unemployment which, when combined with monthly national administrative data, provide comparable unemployment rates, as published in EuroStat's monthly *bulletin Unemployment in the European Union*. Additionally, the preparation of policy actions in the field of EU social and regional policy through the operation of the Structural Funds relies upon the availability of a solid base of comparable data from the EU Labour Force Survey.

The survey results are completely integrated into the EuroStat statistical system, so that they may be consulted for example through the New Cronos and Regio databases. Users with specific data requirements which are not satisfied by the existing publications and databases may also ask for specified tables to be produced on a chargeable basis. Several hundred such requests are received each year from different public and private bodies, research institutes, universities, etc. They may be addressed to the central EuroStat Information Office (+352-4301-34567; fax 4301-436404), and EuroStat is currently extending its data dissemination facilities, setting up Data Shops in every Member State.

The growing volume of this demand for information is an eloquent testimony to the central role of the Labour Force Survey in the European Statistical System. In the field of social statistics there is no other instrument which provides information on social and economic developments within the European Union over such a long time-span, with such a large sample-size or with such a level of comparability.

SECTION 4: TECHNICAL FEATURES OF THE EU LABOUR FORCE SURVEY

Field of the Survey

The survey is intended to cover the whole of the resident population, i.e. all persons whose usual place of residence is in the territory of the Member States of the European Union. For technical and methodological reasons, however, it is not possible in all countries to include the population living in collective households, i.e. persons living in homes, boarding schools, hospitals, religious institutions, workers' hostels, etc.

Consequently, for the purpose of harmonising the field of survey, results are compiled for the population of private households only. This comprises all persons living in the households surveyed during the reference week, and those persons absent from the household for short periods due to studies, holidays, illness, business trips, etc.

It does not cover persons who, although having links with the household under survey:

- (a) usually live in another household;
- (b) live in collective households (in particular, persons doing compulsory military service are excluded from the population of private households and regarded as members of collective households, even if during the reference week they are present in the private household to which they belong);
- (c) have emigrated.

Reference period

The labour force characteristics of each person interviewed refer to their situation in a particular week. While this reference week falls in spring in all countries, the national statistical institutes determine the exact week(s) according to the particular situation in each country. The reference weeks used in the different Member States are shown in the yearly reports containing the survey results. As a general rule the reference week should be a normal week, i.e. it should exclude bank holidays. For countries using a fixed reference week, this requirement is easy to fulfil. In some countries, however, the survey extends over a period of time and, as the reference week is the one preceding the week of the interview, the reference week varies. In this case, the reference week may sometimes include public holidays, such as Easter.

Units of measurement

The main units of measurement for which results are obtained from the survey are individuals and households. The definition of a household varies somewhat from country to country but these differences are unlikely in the majority of cases to have a significant effect on the comparability of the results.

Reliability of the results

As with any sample survey, the results of the Labour Force Survey are subject to sampling errors. In addition, the results of any sample survey are affected by non-sampling errors, i.e. the whole variety of errors other than those due to sampling. These can be due to many factors such as inability or unwillingness of respondents to provide correct answers or even any answer at all (non-response), mistakes by interviewers when filling in survey documents, miscoding, etc. Methods exist to assess the influence of these non-sampling errors on the accuracy of the survey results, but being often costly, are not generally applied.

Experience shows that at national level the survey information provides sufficiently accurate estimates for the levels and structures of the various aggregates into which the labour force is divided, provided that analyses of this type are confined to levels of a certain size. Survey results at regional level may, however, be affected by considerable sampling errors, even for relatively large groups of the population. Reliability of the results is assured by the size of the samples and the sampling methods used, in addition to careful and thorough planning of the various survey operations and rigorous administration of all phases of the survey.

Comparability of results between countries

Perfect comparability among the countries is difficult to achieve, even were it to be by means of a single direct survey, i.e. a survey carried out at the same time, using the same questionnaire and a single method of recording.

Nevertheless, the degree of comparability of the EU Labour Force Survey results is considerably higher than that of any other existing set of statistics on employment or unemployment available for Member States. This is due to:

- (i) the recording of the same set of characteristics in each country;
- (ii) a close correspondence between the EU list of questions and the national questionnaires;
- (iii) the use of the same definitions for all countries;
- (iv) the use of common classifications (e.g. NACE for economic activity);
- (v) the synchronisation of the survey in spring;
- (vi) the data being centrally processed by EuroStat.

The EU Labour Force Survey, although subject to the constraints of the EU's statistical requirements, is a joint effort by Member States to co-ordinate their national employment surveys, which must serve their own national requirements. Therefore, in spite of the close co-ordination between the national statistical institutes and EuroStat, there inevitably remain some differences in the survey from country to country. This is especially the case for population coverage, labour status coverage, main economic activity definition, participation in education, highest educational level attainment and transition to a quarterly continuous survey. The new LFS Explanatory Notes developed for implementation from quarter 1, 2008, have been designed to ensure greater harmonisation and comparability of results between countries.

Comparability of results between successive surveys

Since 1983 improved comparability between results of successive surveys has been achieved, mainly due to the greater stability of content and the higher frequency of surveys. However, the following factors may somewhat detract from perfect comparability:

- (i) the population figures used for the population adjustment are revised at intervals on the basis of new population censuses;
- (ii) the reference period may not remain the same for a given country;
- (iii) in order to improve the quality of results, some countries may change the content or order of their questionnaire;
- (iv) countries may modify their sample designs;
- (v) the manner in which certain questions are answered may be influenced by the political or social circumstances at the time of interview.

EuroStat has provided the main factors affecting the comparability of the data for successive surveys in their publications containing the results.

Basic concepts and definitions

The main statistical objectives of the Labour Force Survey is to divide the population of working age (15 years and above) into three mutually exclusive and exhaustive groups - persons in employment, unemployed persons and inactive persons - and to provide descriptive and explanatory data on each of these categories. Respondents are assigned to one of these groups on the basis of the most objective information possible obtained through the survey questionnaire, which principally relates to their actual activity within a particular reference week.

The definitions of employment and unemployment used in the Labour Force Survey closely follow those adopted by the 13th International Conference of Labour Statisticians.

The relevant parts of these 'ILO definitions' are:

Employment

9.(1) The employed comprise all persons above a specified age who during a specified brief period, either one week or one day, were in the following categories:

- (a) "paid employment":
 - (al) "at work": persons who during the reference period performed some work for wage or salary, in cash or in kind;
 - (a2) "with a job but not at work": persons who, having already worked in their present job, were temporarily not at work during the reference period and had a formal attachment to their job. This formal job attachment should be determined in the light of national circumstances, according to one or more of the following criteria:
 - (i) the continued receipt of wage or salary;
 - (ii) an assurance of return to work following the end of the contingency, or an agreement as to the date of return;
 - (iii) the elapsed duration of absence from the job which, wherever relevant, may be that duration for which workers can receive compensation benefits
 - (bl) "at work": persons who during the reference period performed some work for profit or family gain, in cash or in kind;
 - (b2) "with an enterprise but not at work": persons with an enterprise, which may be a business enterprise, a farm or a service undertaking, who were temporarily not at work during the reference period for any specific reason.

9.(2) For operational purposes, the notion of "some work" may be interpreted as work for at least one hour.

Unemployment

10.(1) The "unemployed" comprise all persons above a specified age who, during the reference period, were:

- (a) "without work", i.e. were not in paid employment or self-employment, as defined in paragraph 9;
- (b) "currently available for work", i.e. were available for paid employment or self-employment during the reference period-;
- (c) "seeking work", i.e. had taken specific steps in a specified recent period to seek paid employment or self-employment.

In applying these definitions to the EU Labour Force survey, the following reference periods are implemented:

- (i) In paragraph 10(b) "currently available" should mean available to start work within two weeks of the reference period.
- (ii) In paragraph 10(c) the "specified recent period" is the four weeks preceding the survey interview. During this period at least one active method to find work should be undertaken in order to satisfy the criterion of "seeking work".

Unemployed persons can be classified by reason for unemployment into four major groups-.

- (1) job-losers are persons whose employment ended involuntarily and immediately began looking for work;
- (2) job-leavers are persons who quit or otherwise terminated their employment voluntarily and immediately began looking for work-;
- (3) re-entrants are persons who previously worked, but were inactive or on compulsory military service before beginning to look for work;
- (4) first job-seekers are persons who have never worked in a regular job.

Labour force

The labour force comprises persons in employment and unemployed persons.

Inactive persons

All persons who are not classified as employed or unemployed are defined as inactive. Apart from showing pupils and students separately, no further breakdown is provided for this group. Conscripts on compulsory military or community service are excluded from the compilation of the survey results.

The above groups are used to derive the following measures:

- (a) *Activity rates*
Activity rates represent the labour force as a percentage of the population of working age (15 years or more).

- (b) *Employment/ population ratios*

Employment / population ratios represent persons in employment as a percentage of the population of working age (15 years or more).

(c) *Unemployment rates*

Unemployment rates represent unemployed persons as a percentage of the labour force.

(d) *Duration of unemployment*

defined as the shorter of the following two periods (a)the duration of search for work, or (b)the length of time since last employment.

The above rates are usually calculated for sex-age groups and are sometimes further cross-classified by other demographic variables such as marital status or nationality.

SECTION 5a:

COUNCIL REGULATION 577/98 OF THE EUROPEAN UNION

Whereas, in order to carry out the tasks assigned to it, the Commission needs comparable statistical information on the level and pattern of and trends in employment and unemployment in the Member States;

Whereas the best method of obtaining such information at Community level is to conduct harmonised labour force surveys;

Whereas Council Regulation (EEC) No 3711/91 of 16 December 1991 on the organisation of an annual labour force sample survey in the Community laid down that, starting in 1992, a survey was to be conducted in the spring of each year;

Whereas, although a continuous survey is preferable to an annual spring survey for ensuring the availability and harmonisation of data and measuring the volume of work, it is difficult to implement a continuous survey on the same dates in all Member States.

Whereas the use of existing administrative sources should be encouraged insofar as they can usefully supplement the information obtained through interviews or serve as a sampling basis;

Whereas the date in the survey, as fixed by this Regulation, may be extended to include a further set of variables forming part of a programme of ad hoc modules which covers several years, and which will be drawn up under an appropriate procedure as part of the implementation arrangements;

Whereas the principles of relevance and cost-effectiveness, as these are defined in Council Regulation (EC) No 322/97 of 17 February 1997 on Community Statistics which constitutes the legislative framework for the production of Community statistics, will also apply to this Regulation;

Whereas statistical confidentiality is governed by the rules set out in Regulation (EC) No 322/97 and in Council Regulation (Euratom, EEC) No 1588/90 of 11 June 1990 on the transmission of data subject to statistical confidentiality to the Statistical Office of the European Communities;

Whereas the Statistical Programme Committee established by Decision 89/382/EEC, Euratom has been consulted by the Commission in accordance with Article 3 of the aforesaid Decision,
has adopted this regulation:

Article I **Frequency of the survey**

A labour force sample survey, hereinafter referred to as 'the survey', shall be conducted by the Member States each year.

The survey is a continuous survey providing quarterly and annual results; however, those Member States which are not in a position to implement a continuous survey may carry out an annual survey only, to take place in the spring.

The information collected during the survey relates generally to the situation during the course of the week (taken to run from Monday to Sunday) preceding the interview, known as the reference week.

In the case of a continuous survey:

the reference weeks are spread uniformly throughout the whole year;

- the interview normally takes place during the week immediately following the reference week. The reference week and the date of the interview may not be more than five weeks apart, except in the third quarter;
- the reference quarters and years are respectively groups of 13 or 52 consecutive weeks. A list of the weeks making up a given quarter or year is drawn up according to the procedure laid down in Article 8.

Article 2

Units and scope of the survey, observation methods

1. The survey shall be carried out in each Member State in a sample of households or of persons residing in the economic territory of that State at the time of the survey.
2. The principal scope of the survey consists of persons residing in private households on the economic territory of each Member State. If possible, this main population of persons living in private households is supplemented by persons living in Collective households.

Wherever possible, Collective households are covered by means of samples specially drawn to permit direct observation of the persons concerned. If this is not possible, then persons in these groups who continue to have an association with a private household are included in connection with that household.

3. The variables used to determine labour status and underemployment must be obtained by interviewing the person concerned, or, if this is not possible, another member of the household. Other information may be obtained from alternative sources, including administrative records, provided that the data obtained are of equivalent quality.
4. Regardless of whether the sampling unit is an individual or a household, information is usually collected for all individuals of the household. However, If the sampling unit is an individual, the information concerning the other members of the household
 - may exclude the characteristics listed under Article 4(1)(g), (h), (i) and (j),
 - and may be Collected from a sub-sample defined in such a way that:
 - the reference weeks are uniformly distributed throughout the whole year;
 - the number of observations (individuals sampled plus the members of their household) satisfies, for the annual estimates of levels, the reliability criteria defined in Article 3.

Article 3
Representativeness of the sample

1. For a group of unemployed people representing 5% of the working age population the relative standard error for the estimation of annual averages (or for the spring estimates in the case of an annual survey in the spring) at NUTS II level shall not exceed 8% of the sub-population in question. Regions with less than 300,000 inhabitants shall be exempt from this requirement.
2. In the case of a continuous survey, for sub-populations which constitute 5% of the working age population the relative standard error at national level for the estimate of changes between two successive quarters, shall not exceed 2 % of the sub-population in question.

For Member States with a population of between one million and twenty million inhabitants, this requirement is relaxed so that the relative standard error for the estimate of quarterly changes shall not exceed 3% of the sub-population in question.

Member States whose population is below one million inhabitants are exempt from these precision requirements concerning changes.

3. Where the survey is carried out only in the spring, at least a quarter of the survey units are taken from the preceding survey and at least a quarter form part of the following survey.

These two groups shall be identified by a code.

4. Where non-response to certain questions results in missing data, a method of statistical imputation shall be applied where appropriate.
5. The weighting factors we calculated taking into account in particular the probability of selection and external data relating to the distribution of the population being surveyed by sex, age (five-year age groups), and region (NUTS II level), where such external data are held to be sufficiently reliable by the Member States concerned.
6. Member States shall provide the Commission (EuroStat) with whatever information is required concerning the organisation and methodology of the survey, and in particular, they shall indicate the criteria adopted for the design and size of the sample.

Article 4
Survey characteristics

1. Data shall be provided on;
 - (a) demographic background:
 - sequence number in the household
 - sex
 - year of birth
 - date of birth in relation to the end of the reference period
 - marital status
 - relationship to reference person

- sequence number of spouse
 - sequence number of father
 - sequence number of mother
 - nationality
 - number of years of residence in the Member State
 - country of birth (optional)
 - nature of participation in the survey (direct participation or proxy through another member of the household);
- (b) labour status;
- labour status during the reference week
 - reason for not having worked though having a job
 - search for employment for person without employment
 - type of employment sought (self-employed or employee)
 - methods used to find a job
 - availability to start work;
- (c) employment characteristics of the main job:
- professional status
 - economic activity of local unit
 - occupation
 - number of persons working at the local unit
 - country of place of work
 - region of place of work
 - year and month when the person started working in current employment
 - permanency of the job (and reasons)
 - duration of temporary job or work contract of limited duration
 - full-time/part-time distinction (and reasons)
 - working at home;
- (d) hours worked:
- number of hours per week usually worked
 - number of hours actually worked
 - main reason for hours actually worked being different from person's usual hours;
- (e) second job:
- existence of more than one job
 - professional status
 - economic activity of the local unit
 - number of hours actually worked
- (f) visible underemployment:
- wish to work usually more than the current number of hours (optional in the case of an annual survey)
 - looking for another job and reasons for doing so
 - type of employment sought (as employee or otherwise)
 - methods used to find another job

- reasons why the person is not seeking another job (optional in the case of an annual survey)
- availability to start work
- number of hours of work wished for (optional in the case of an annual survey);
- (g) search for employment:
 - type of employment sought (full-time or part-time)
 - duration of search for employment
 - situation of person immediately before starting to seek employment
 - registration at public employment office and whether receiving benefits
 - willingness to work for person not seeking employment
 - reasons why person has not sought work;
- (h) education and training
 - participation in education or training during previous four weeks
 - purpose
 - level
 - type
 - total length
 - total number of hours
 - highest successfully completed level of education or training
 - year when this highest level was successfully completed
 - non-tertiary vocational qualification obtained;
- (i) previous work experience of person not in employment:
 - existence of previous employment experience
 - year and month in which the person last worked
 - main reason for leaving last job or business
 - professional status in last job
 - economic activity of local unit in which person last worked
 - occupation of last job;
- (j) situation one year before the survey (optional for quarters 1, 3, 4):
 - main labour status
 - professional status
 - economic activity of local unit in which person was working
 - country of residence;
 - region of residence;
- (k) main labour status (optional);
- (l) income (optional);
- (m) technical items relating to the interview
 - year of survey
 - reference week
 - interview week
 - member State

- region of household
 - degree of urbanisation
 - serial number of household
 - type of household
 - type of institution
 - weighting factor
 - sub-sample in relation to the preceding survey (annual survey)
 - sub-sample in relation to the following survey (annual survey)
 - sequence number of the survey wave.
2. A further set of variables, hereinafter referred to as an “ad hoc module”, may be added to supplement the information described above in paragraph 1.

A programme of ad hoc modules covering several years shall be drawn up each year according to the procedure laid down in Article 8:

- this programme shall specify for each ad hoc module, the subject, the reference period, the sample size (equal to or less than the sample size determined according to Article 3) and the deadline for the transmission of the results (which may be different from the deadline according to Article 6);
 - the Member States and regions covered and the detailed list of information to be collected in an ad hoc module shall be drawn up at least twelve months before the beginning of the reference period for that module;
 - the volume of an ad hoc module shall not exceed the volume of the module described under paragraph 1
3. The definitions, the edits to be used, the codification of the variables, the adjustment of the list of survey variables made necessary by the evolution of techniques and concepts, and a list of principles for the formulation of the questions concerning the labour status, are drawn up according to the procedure laid down in Article 8.

Article 5 **Conduct of the survey**

The Member States may make it compulsory to reply to the survey.

Article 6 **Transmission of the results**

Within twelve weeks of the end of the reference period in the case of a continuous survey (and within nine months of the end of the reference period in the case of a survey in the spring), the Member States shall forward to EuroStat the results of the survey, without direct identifiers.

Article 7 Reports

A report on the implementation of this regulation shall be submitted to the commission to the Parliament and the Council every three years, beginning in the year 2000. This report shall evaluate in particular the quality of the statistical methods envisaged by the member states to improve the results or to lighten the survey procedures.

Article 8 Procedure

The Commission shall be assisted by the Statistical Programme Committee, hereinafter referred to as "the Committee".

The representative of the Commission shall submit to the Committee a draft of the measures to be taken. The Committee shall deliver its opinion on the draft within a time limit which the chairman may lay down according to the urgency of the matter. The opinion shall be delivered by the majority laid down in Article 148(2) of the Treaty in the case of decisions which the Council is required to adopt on a proposal from the Commission. The votes of the representatives of the Member States within the Committee shall be weighted in the manner set out in that Article. The chairman shall not vote.

The Commission shall adopt the measures envisaged if they are in accordance with the opinion of the Committee.

If the measures envisaged are not in accordance with the opinion of the Committee, or if no opinion is delivered, the commission shall, submit to the council a proposal relating to the measures to be taken. The council shall act by a qualified majority.

If, on the expiry of a period of three months from the date of referral to the Council, the Council has not acted, the proposed measures shall be adopted by the Commission.

Note that Commission Regulation (EC) No 1575/2000 of 19 July 2000 implements Council Regulation (EC) No 577/98 on the organisation of a labour force sample survey in the Community concerning the codification to be used for data transmission from 2001 to 2005 (OJ No L 181/16).

The 2001 to 2005 codification can be found at
http://forum.europa.eu.int/irc/dsis/employment/info/data/eu_lfs/lfs_regulations.htm

Note that Commission Regulation (EC) No 430/2005 of 15 March 2005 implements Council Regulation (EC) No 577/98 on the organisation of a labour force sample survey in the Community concerning the codification to be used for data transmission from 2006 onwards.

Note that Commission Regulation (EC) No 377/2008 of 25 April 2008 implements Council Regulation (EC) No 577/98 on the organisation of a labour force sample survey in the Community concerning the codification to be used for data transmission from 2008 onwards.

SECTION 5b: COMMISSION REGULATION 2257/2003 OF THE EUROPEAN UNION

This is an amendment of Council Regulation (EC) No 577/98.

Whereas:

- (1) The labour force sample survey to be carried out under Council Regulation (EC) No 577/98 should adequately cover new and recently emerging features of the labour market.
- (2) According to the European social policy agenda adopted by the Nice European Council in December 2000, Council Decision 2002/177/EC of 18 February 2002 on guidelines for Member States' employment policies for the year 2002 and Council Recommendation 2002/549/EC of 21 June 2002 on the broad guidelines of the economic policies of the Member States and the Community, the way in which work is organised must be adapted to the needs of both businesses and individuals.
- (3) The survey characteristics laid down in Regulation (EC) No 577/98 were determined according to statistical needs and the labour market situation prevailing at the time.
- (4) Data collection should not impose on respondents a burden out of proportion with the results which users of the survey can reasonably expect.
- (5) The Statistical Programme Committee, established by Council Decision 89/382/EEC, Euratom of 19 June 1989 has been consulted by the Commission.
- (6) Regulation (EC) No 577/98 should therefore be amended accordingly,

HAVE ADOPTED THIS REGULATION:

Article 1

Article 4 of Regulation (EC) No 577/98 is hereby amended as follows:

1. Points (b), (c), (d) and (g) of paragraph 1 are replaced by the following:

‘(b) labour status:

- labour status during the reference week,
- continuing receipt of wages and salary,
- reason for not having worked though having a job,
- search for employment for person without employment,
- type of employment sought (self-employed or employee),
- methods used to find a job,
- availability to start work;

(c) employment characteristics of the main job:

- professional status,
- economic activity of the local unit,
- occupation,
- supervisory responsibilities,
- number of persons working at the local unit,
- country of place of work,
- region of place of work,
- year and month when the person started working in current employment,

- involvement of public employment service in finding the current job,
- permanency of the job (and reasons),
- duration of temporary job or work contract of limited duration,
- full-time/part-time distinction (and reasons),
- contract with a temporary work agency,
- working at home;

(d) hours worked:

- number of hours per week usually worked,
- number of hours actually worked,
- number of hours of overtime in the reference week,
- main reason for hours actually worked being different from usual hours;'

'(g) search for employment:

- type of employment sought,
- duration of search for employment,
- situation of person immediately before starting to seek employment,
- registration at public employment office and whether receiving benefits,
- for person not seeking employment, willingness to work,
- reasons why person has not sought work,
- lack of care facilities.'

2. The following point is added to paragraph 1:

'(n) atypical working times:

- shift work,
- evening work,
- night work,
- Saturday work,
- Sunday work.'

3. Paragraph 2, third indent, is replaced by the following:

- '— the volume of an ad hoc module shall be limited to 11 variables.'

4. The following paragraph shall be added:

'4. On a proposal from the Commission, a list of variables, hereinafter referred to as "structural variables", may be identified from among the survey characteristics specified in paragraph 1 which need to be surveyed only as annual averages with reference to 52 weeks rather than as quarterly averages. This list of structural variables, the minimum sample size and the survey frequency will be drawn up in accordance with the procedure laid down in Article 8. Spain, Finland and the United Kingdom may survey the structural variables with reference to a single quarter during a transition period until the end of 2007.'

Article 2

This Regulation shall enter into force on the 20th day following its publication in the *Official Journal of the European Union*.

This Regulation shall be binding in its entirety and directly applicable in all Member States.

SECTION 5c:

COMMISSION REGULATION 430/2005 OF THE EUROPEAN UNION

This regulation implements Council Regulation (EC) No 577/98 on the organisation of a labour force sample survey in the Community concerning the codification to be used for data transmission from 2006 onwards and the use of a sub-sample for the collection of data on structural variables.

Having regard to Council Regulation (EC) No 577/98 of 9 March 1998 on the organisation of a labour force sample survey in the Community, and in particular Articles 3, 4 and 4 thereof, Whereas:

(1) In accordance with Article 4 of Regulation (EC) No 577/98 implementing measures are necessary in order to define the codification of the variables to be used for the data transmission.

(2) Under Article 4 of Regulation (EC) No 577/98 a list of variables, hereinafter referred to as structural variables, may be identified from among the survey characteristics which need to be surveyed only as annual averages with reference to 52 weeks rather than as quarterly averages. Therefore the conditions for the use of a sub-sample for the collection of data on structural variables should be laid down.

(3) In view of the importance of data on employment and unemployment, the totals for these indicators should be consistent whether they are produced from the annual sub-sample or on the basis of an annual average of the four quarterly full samples.

(4) In view of the importance of data collected in ad hoc modules, this information should be combinable with any other variable from the survey.

(5) The measures provided for in this Regulation are in accordance with the opinion of the Statistical Programme Committee established by Council Decision 89/382/EEC, Euratom, has adopted this regulation:

Article 1

The conditions for the use of a sub-sample for the collection of data on structural variables are laid down (below)

Article 2

The codes for the variables to be used for data transmission for the years 2006 onwards are laid down in Annex II.

Article 3

This Regulation shall enter into force on the twentieth day following that of its publication in the *Official Journal of the European Union*.

This Regulation shall be binding in its entirety and directly applicable in all Member States.

Conditions for the use of a sub-sample for the collection of data on structural variables

1. Yearly/quarterly variables

The word 'yearly' in the 'Periodicity' column of the Codification laid down in the next section, identifies structural variables which optionally need only to be surveyed as annual averages, using a sub-sample of independent observations with reference to 52 weeks, rather than as quarterly averages. Core variables to be surveyed each quarter are identified as 'quarterly'.

2. Representativeness of the results

For structural variables, the relative standard error (without taking design effect into account) of any yearly estimate representing 1 % or more of the working age population shall not exceed:

- (a) 9 % for countries with a population between 1 million and 20 million inhabitants and
- (b) 5 % for countries with a population of 20 million or more.

Countries with less than 1 million inhabitants are exempted from these precision requirements and structural variables should be collected for the total sample unless the sample meets requirements expressed in (a).

For countries using a sub-sample for data collection on structural variables, if more than one wave is used, the total sub-sample used shall consist of independent observations.

3. Consistency of totals

Consistency between annual sub-sample totals and full sample annual averages shall be ensured for employment, unemployment and inactive population by sex and for the following age groups: 15 to 24, 25 to 34, 35 to 44, 45 to 54, 55 +.

4. Ad hoc modules

The sample used to collect information on ad hoc modules shall also provide information on structural variables.

SECTION 5d:

COMMISSION REGULATION 377/2008 OF THE EUROPEAN UNION

This regulation implements Council Regulation (EC) No 577/98 on the organisation of a labour force sample survey in the Community as regards the codification to be used for data transmission from 2009 onwards, the use of a sub-sample for the collection of data on structural variables and the definition of the reference quarters.

Having regard to Council Regulation (EC) No 577/98 of 9 March 1998 on the organisation of a labour force sample survey in the Community¹, and in particular Articles 1 and 4(3) thereof, Whereas:

(1) Article 1 of Regulation (EC) No 577/98 requires that, in the case of a continuous survey, a list of the weeks making up the reference quarters for the survey is drawn up by the Commission.

(2) In accordance with Article 4(3) of Regulation (EC) No 577/98, implementing measures are necessary in order to define the codification of the variables to be used for the data transmission.

(3) Under Article 4(4) of Regulation (EC) No 577/98, a list of variables, hereinafter referred to as structural variables, may be identified from among the survey characteristics which need to be surveyed only as annual averages with reference to 52 weeks rather than as quarterly averages. Therefore, the conditions for the use of a sub-sample for the collection of data on structural variables should be laid down.

(4) In view of the importance of data on employment and unemployment, the totals for these indicators should be consistent whether they are produced from the annual sub-sample or on the basis of an annual average of the four quarterly full samples.

(5) In view of the importance of data collected in ad hoc modules, this information should be combinable with any other variable from the survey.

(6) Regulation (EC) No 577/98 as amended by Regulation (EC) No 1372/2007 of the European Parliament and of the Council makes the transmission of the variable 'wages from the main job' compulsory. Therefore, the codification of the variables should be amended.

(7) Commission Regulation (EC) No 430/2005 implementing Council Regulation (EC) No 577/98 on the organisation of a labour force sample survey in the Community concerning the codification to be used for data transmission from 2006 onwards and the use of a sub-sample for the collection of data on structural variables² defines the codification to be used for the data transmission from 2006 onwards. However, it is necessary to amend the coding scheme from 2009 onwards in order to take account of changes in two variables (field of highest level of education or training successfully completed and monthly pay from main job), to adapt the transmission columns accordingly and to correct some filter errors and omissions for other

¹OJ L 77, 14.3.1998, p. 3. Regulation last amended by Regulation (EC) No 1372/2007 of the European Parliament and of the Council (OJ L 315, 3.12.2007, p. 42)

² OJ L 71, 17.3.2005, p. 36. Regulation last amended by Regulation (EC) No 973/2007 (OJ L 216, 21.8.2007, p. 10).

variables. Commission Regulation (EC) No 430/2005 should therefore be repealed with effect from 1 January 2009.

(8) The measures provided for in this Regulation are in accordance with the opinion of the Statistical Programme Committee established by Council Decision 89/382/EEC, Euratom³, has adopted this regulation:

Article 1

The conditions for the use of a sub-sample for the collection of data on structural variables are laid down in Annex I.

Article 2

The definition of the reference quarters to be applied from 2009 is laid down in Annex II.

Article 3

The codes for the variables to be used for the data transmission for the years 2009 onwards are laid down in Annex III.

Article 4

Regulation (EC) No 430/2005 shall be repealed with effect from 1 January 2009.

Article 5

This Regulation shall enter into force on the twentieth day following that of its publication in the *Official Journal of the European Union*.

It shall apply from 1 January 2009. This Regulation shall be binding in its entirety and directly applicable in all Member States.

ANNEX I

1. Yearly/quarterly variables

The word 'yearly' in the 'Periodicity' column of the Codification laid down in Annex III identifies structural variables which optionally need only to be surveyed as annual averages, using a sub-sample of independent observations with reference to 52 weeks, rather than as quarterly averages. Core variables to be surveyed each quarter are identified as 'quarterly'.

2. Representativeness of the results

For structural variables, the relative standard error (without taking design effect into account) of any yearly estimate representing 1 % or more of the working-age population shall not exceed:

(a) 9 % for countries with a population between 1 million and 20 million inhabitants and,

(b) 5 % for countries with a population of 20 million or more.

Countries with fewer than 1 million inhabitants are exempted from these precision requirements, and structural variables should be collected for the total sample unless the sample meets the requirements set out in (a).

³ OJL 181, 28.6.1989, p. 47

For countries using a sub-sample for data collection on structural variables, if more than one wave is used, the total subsample used shall consist of independent observations.

3. Consistency of totals

Consistency between annual sub-sample totals and full-sample annual averages shall be ensured for employment, unemployment and inactive population by sex and for the following age groups: 15 to 24, 25 to 34, 35 to 44, 45 to 54, 55 +.

4. Ad hoc modules

The sample used to collect information on ad hoc modules shall also provide information on structural variables.

ANNEX II

(a) Quarters of each year refer to the 12 months of the year, so that January, February and March belong to the first quarter, April, May and June to the second quarter, July, August and September to the third quarter and October, November and December to the fourth quarter.

(b) The reference weeks are allocated to the reference quarters so that a week belongs to the quarter as defined in (a) to which at least four days of that week belong, unless this results in the first quarter of the year consisting of only 12 weeks. When that occurs, the quarters of the year in question will be formed by consecutive blocks of 13 weeks.

(c) When, according to (b), a quarter consists of 14 weeks instead of 13 weeks the Member States should attempt to spread the sample over all of the 14 weeks.

(d) If it is not feasible to spread the sample to cover all 14 weeks of the quarter, the Member State concerned may skip one week of that quarter (i.e. not cover it). The week to be skipped should be typical with regard to unemployment, employment and average actual hours worked and should be part of a month containing five Thursdays.

(e) The first quarter of 2009 shall start on Monday, 29 December 2008. Until the end of 2011, Member States running the Labour Force Survey along with other surveys as one single integrated survey may define the start of reference quarters one week earlier than laid down in (a), (b) and (e).

**SECTION 6:
EU LABOUR FORCE SURVEY - DATA CODIFICATION 2009**

Eurostat Name	Column	Periodicity	Code	Description	Filter/Remarks
HHSEQNUM	1/2	QUARTERLY		DEMOGRAPHIC BACKGROUND <i>Sequence number in the household (it should remain the same for all waves)</i>	everybody
			01-98	Two-digit sequence number allocated to each member of the household	
HHLINK	3	YEARLY		<i>Relationship to reference person in the household</i>	HHTYPE =1,3
			1	Reference person	
			2	Spouse (or cohabiting partner) of reference person	
			3	Child of reference person (or of his/her spouse or cohabiting partner)	
			4	Ascendant relative of reference person (or of his/her spouse or cohabiting partner)	
			5	Other relative	
			6	Other	
			9	Not applicable (HHTYPE ≠1,3)	
HHSPOU	4/5	YEARLY		<i>Sequence number of spouse or cohabiting partner</i>	HHTYPE =1,3
			01-98	Sequence number of spouse or cohabiting partner in the household	
			99	Not applicable (person does not belong to a private household, or has no partner, or the partner does not belong to this private household)	
HHFATH	6/7	YEARLY		<i>Sequence number of father</i>	HHTYPE =1,3
			01-98	Sequence number of father in the household	
			99	Not applicable (person does not belong to a private household, or the father does not belong to this private household)	
HHMOTH	8/9	YEARLY		<i>Sequence number of mother</i>	HHTYPE =1,3
			01-98	Sequence number of mother in the household	
			99	Not applicable (person does not belong to a private household, or the mother does not belong to this private household)	
SEX	10	QUARTERLY		Sex	everybody
			1	Male	
			2	Female	
YEARBIR	11/14	QUARTERLY		<i>Year of birth</i>	everybody
				The 4 digits of year of birth are entered	
DATEBIR	15	QUARTERLY		<i>Date of birth in relation to the end of reference period</i>	everybody
			1	Person's birthday falls between 1 January and the end of the reference week	
			2	Person's birthday falls after the end of the reference week	
MARSTAT	16	YEARLY		<i>Marital status</i>	everybody
			1	Single	
			2	Married	
			3	Widowed	
			4	Divorced or legally separated	
			blank	No answer	
NATIONAL	17/18	QUARTERLY		<i>Nationality</i>	everybody

Labour Force Survey - United Kingdom

YEARESID	19/20	YEARLY		For coding, see ISO country classification (Annex IV) <i>Years of residence in this Country</i>	Everybody
			00	Born in this Country	
			01-99	Number of years of residence in this country	
			blank	No answer	
COUNTRYB	21/22	QUARTERLY		<i>Country of birth</i>	YEARESID≠00
			99	For coding, see ISO country classification (Annex IV) Not applicable (Col.19/20=00)	
			blank	No answer	
PROXY	23	QUARTERLY		<i>Nature of participation in the survey</i>	everybody aged 15 years or more
			1	Direct participation	
			2	Participation via another member of the household	
			9	Not applicable (child less than 15 years old)	
			blank	No answer	
				LABOUR STATUS	
WSTATOR	24	QUARTERLY		<i>Labour status during the reference week</i>	everybody aged 15 years or more
			1	Did any work for pay or profit during the reference week - one hour or more (including family workers but excluding conscripts on compulsory military or community service)	
			2	Was not working but had a job or business from which he/she was absent during the reference week (including family workers but excluding conscripts on compulsory military or community service)	
			3	Was not working because on lay-off	
			4	Was a conscript on compulsory military or community service	
			5	Other (15 years or more) who neither worked nor had a job or business during the reference week	
			9	Not applicable (child less than 15 years old)	
NOWKREAS	25/26	QUARTERLY		<i>Reason for not having worked at all though having a job</i>	WSTATOR=2
			00	Bad weather	
			01	Slack work for technical or economic reasons	
			02	Labour dispute	
			03	School education or training	
			04	Own illness, injury or temporary disability	
			05	Maternity leave	
			06	Parental leave	
			07	Holidays	
			08	Compensation leave (within the framework of working time banking or an annualised hours contract)	
			09	Other reasons (e.g. personal or family responsibilities)	
			99	Not applicable (WSTATOR=1,3-5,9)	
				EMPLOYMENT CHARACTERISTICS OF THE MAIN JOB	
STAPRO	27	QUARTERLY		<i>Professional status</i>	WSTATOR=1,2
			1	Self-employed with employees	
			2	Self-employed without employees	
			3	Employee	
			4	Family worker	
			9	Not applicable (WSTATOR=3-5,9)	
			blank	No answer	

Labour Force Survey - United Kingdom

SIGNISAL	28	QUARTERLY	1 2 3 4 9	<i>Continuing receipt of the wage or salary</i> Absent for up to and including 3 months Absent for more than 3 months and receiving a wage, salary or social allowances corresponding to half or more of the salary Absent for more than 3 months and receiving a wage, salary or social allowances corresponding to less than half of the salary Don't know Not applicable ((WSTATOR ≠2 or NOWKREAS = 04 or NOWKREAS = 05 or STAPRO ≠3) and WSTATOR ≠ 3)	(WSTATOR = 2 and NOWKREAS ≠04 and NOWKREAS≠ 05 and STAPRO=3) or WSTATOR = 3
NACE3D	29/31	QUARTERLY	000 blank	<i>Economic activity of the local unit</i> NACE Rev. 2 coded at 2 or if possible 3 digit level Not applicable (WSTATOR=3-5,9) No answer	WSTATOR=1,2
ISCO4D	32/35	QUARTERLY	9999 blank	<i>Occupation</i> ISCO-88 (COM) coded at 3 or if possible 4 digit level Not applicable (WSTATOR=3-5,9) No answer	WSTATOR=1,2
SUPVISOR	36	YEARLY	1 2 9 blank	<i>Supervisory responsibilities</i> Yes No STAPRO ≠ 3 No answer	STAPRO = 3
SIZEFIRM	37/38	YEARLY	01-10 11 12 13 14 15 99 blank	<i>Number of persons working at the local unit</i> Exact number of persons, if between 1 and 10 11 to 19 persons 20 to 49 persons 50 persons or more Do not know but less than 11 persons Do not know but more than 10 persons Not applicable (STAPRO=2,9) No answer	STAPRO=1,3,4, blank
COUNTRYW	39/40	QUARTERLY	99 blank	<i>Country of place of work</i> For coding, see ISO country classification (Annex IV) Not applicable (WSTATOR=3-5,9) No answer	WSTATOR=1,2
REGIONW	41/42	QUARTERLY	99 blank	<i>Region of place of work</i> NUTS 2 Not applicable (WSTATOR=3-5,9) No answer	WSTATOR=1,2
YSTARTWK	43/46	QUARTERLY	9999 blank	<i>Year in which person started working for this employer or as self-employed</i> Enter the 4 digits of the year concerned Not applicable (WSTATOR=3-5,9) No answer	WSTATOR=1,2
MSTARTWK	47/48	QUARTERLY	01-12 99 blank	<i>Month in which person started working for this employer or as self-employed</i> Enter the number of the month concerned Not applicable (YSTARTWK=9999,blank or REFYEAR-YSTARTWK>2) No answer	YSTARTWK≠99 99, blank & REFYEAR - YSTARTWK<= 2
WAYJFOUN	49	YEARLY		<i>Involvement of the public employment office at any</i>	STAPRO = 3 &

Labour Force Survey - United Kingdom

			0	<i>moment in finding the present job</i>	has started this job in the last 12 months
			1	No	
			9	Yes	
			blank	STAPRO ≠ 3 or has started this job more than 1 year ago	
FTPT	50	QUARTERLY	blank	No answer	
				<i>Full-time / Part-time distinction</i>	WSTATOR=1,2
			1	Full-time job	
			2	Part-time job	
			9	WSTATOR≠1,2	
FTPTREAS	51	YEARLY	blank	No answer	
				<i>Reasons for the part-time work</i>	FTPT=2
				Part-time job is taken because:	
			1	Person is undergoing school education or training	
			2	Of own illness or disability	
			3	Looking after children or incapacitated adults	
			4	Other personal or family reasons	
			5	Person could not find a full-time job	
			6	Of other reasons	
			9	Not applicable (FTPT≠2)	
TEMP	52	QUARTERLY	blank	No answer	
				<i>Permanency of the job</i>	STAPRO=3
			1	Person has a permanent job or work contract of unlimited duration	
			2	Person has temporary job/work contract of limited duration	
			9	Not applicable (STAPRO≠3)	
TEMPREAS	53	YEARLY	blank	No answer	
				<i>Reasons for having a temporary job/work contract of limited duration</i>	TEMP =2
				Person has temporary job/work contract of limited duration because:	
			1	It is a contract covering a period of training (apprentices, trainees, research assistants, etc.)	
			2	Person could not find a permanent job	
			3	Person did not want a permanent job	
			4	It is a contract for a probationary period	
			9	Not applicable (TEMP≠2)	
TEMPDUR	54	QUARTERLY	blank	No answer	
				<i>Total duration of temporary job or work contract of limited duration</i>	TEMP=2
			1	Less than one month	
			2	1 to 3 months	
			3	4 to 6 months	
			4	7 to 12 months	
			5	13 to 18 months	
			6	19 to 24 months	
			7	25 to 36 months	
			8	More than 3 years	
			9	Not applicable (TEMP≠2)	
TEMPAGCY	55	YEARLY	blank	No answer	
				<i>Contract with a temporary employment agency</i>	STAPRO=3
			0	No	
			1	Yes	
			9	Not applicable (STAPRO≠3)	
			blank	No answer	

Labour Force Survey - United Kingdom

				ATYPICAL WORK	
SHIFTWK	56	YEARLY		<i>Shift work</i>	STAPRO=3
			1	Person does shift work	
			3	Person never does shift work	
			9	Not applicable (STAPRO ≠ 3)	
			blank	No answer	
EVENWK	57	YEARLY		<i>Evening work</i>	WSTATOR=1 or WSTATOR=2
			1	Person usually works in the evening	
			2	Person sometimes works in the evening	
			3	Person never works in the evening	
			9	Not applicable (WSTATOR=3-5,9)	
			blank	No answer	
NIGHTWK	58	YEARLY		<i>Night work</i>	WSTATOR=1 or WSTATOR=2
			1	Person usually works at night	
			2	Person sometimes works at night	
			3	Person never works at night	
			9	Not applicable (WSTATOR=3-5,9)	
			blank	No answer	
SATWK	59	YEARLY		<i>Saturday work</i>	WSTATOR=1 or WSTATOR=2
			1	Person usually works on Saturdays	
			2	Person sometimes works on Saturdays	
			3	Person never works on Saturdays	
			9	Not applicable (WSTATOR=3-5,9)	
			blank	No answer	
SUNWK	60	YEARLY		<i>Sunday work</i>	WSTATOR=1 or WSTATOR=2
			1	Person usually works on Sundays	
			2	Person sometimes works on Sundays	
			3	Person never works on Sundays	
			9	Not applicable (WSTATOR=3-5,9)	
			blank	No answer	
				HOURS WORKED	
HWUSUAL	61/62	QUARTERLY		<i>Number of hours per week usually worked in the main job</i>	WSTATOR=1,2
			00	Usual hours cannot be given because hours worked vary considerably from week to week or from month to month	
			01-98	Number of hours usually worked in the main job	
			99	Not applicable (WSTATOR=3-5,9)	
			blank	No answer	
HWACTUAL	63/64	QUARTERLY		<i>Number of hours actually worked during the reference week in the main job</i>	WSTATOR=1,2
			00	Person having a job or business and not having worked at all in the main activity during the reference week (WSTATOR=2)	
			01-98	Number of hours actually worked in the main job during the reference week	
			99	Not applicable (WSTATOR=3-5,9)	
			blank	No answer	
HWOVERP	65/66	QUARTERLY		<i>Paid overtime in the reference week in the main job</i>	STAPRO=3
			00-98	Number of paid overtime hours	
			99	Not applicable (STAPRO≠3)	
			blank	No answer	
HWOVERPU	67/68	QUARTERLY		<i>Unpaid overtime in the reference week in the main job</i>	STAPRO=3
			00-98	Number of unpaid overtime hours	

Labour Force Survey - United Kingdom

HOURREAS	69/70	QUARTERLY	99	Not applicable (STAPRO≠3)	HWUSUAL = 00-98 & HWACTUAL = 00-98 & WSTATOR = 1
			blank	No answer	
				<i>Main reason for hours actually worked during the reference week being different from the person's usual hours</i>	
				Person has worked more than usual due to:	
			01	- variable hours (e.g. flexible working hours)	
			16	- overtime	
			02	- other reasons	
				Person has worked less than usual due to:	
			03	- bad weather	
			04	- slack work for technical or economic reasons	
			05	- labour dispute	
			06	- education or training	
			07	- variable hours (e.g. flexible working hours)	
			08	- own illness, injury or temporary disability	
			09	- maternity or parental leave	
			10	- special leave for personal or family reasons	
			11	- annual holidays	
			12	- bank holidays	
			13	- start of/change in job during reference week	
14	- end of job without taking up a new one during reference week				
15	- other reasons				
97	Person having worked usual hours during the reference week (HWUSUAL=HWACTUAL=01-98)				
98	Person whose hours vary considerably from week to week or month to month and who did not state a reason for a divergence between the actual and usual hours (HWUSUAL=00 & HOURREAS#01-16)				
99	Not applicable (WSTATOR=2-5,9 or HWUSUAL=blank or HWACTUAL= blank)				
blank	No answer				
WISHMORE	71	QUARTERLY		<i>Wish to work usually more than the current number of hours</i>	(WSTATOR=1 or WSTATOR=2)
			0	No	
			1	Yes	
			9	Not applicable (WSTATOR=3-5, 9)	
			blank	No answer	
WAYMORE	72	YEARLY		<i>Way how person wants to work more hours</i>	WISHMORE=1
			1	Through an additional job	
			2	Through a job working more hours than the present job	
			3	Only within the present job	
			4	In any of the above ways	
			9	Not applicable (WISHMORE≠1)	
			blank	No answer	
HWWISH	73/74	QUARTERLY		<i>Number of hours that the person would like to work in total</i>	WSTATOR=1 or WSTATOR=2
			01-98	Number of hours wished to work in total	
			99	Not applicable (WSTATOR=3-5,9)	
			blank	No answer	
HOMEWK	75	YEARLY		<i>Working at home</i>	WSTATOR=1 or WSTATOR=2
			1	Person usually works at home	
			2	Person sometimes works at home	
			3	Person never works at home	
			9	Not applicable (WSTATOR=3-5,9)	

Labour Force Survey - United Kingdom

LOOKOJ	76	QUARTERLY	blank	No answer <i>Looking for another job</i>	WSTATOR=1 or WSTATOR=2
			0	Person is not looking for another job	
			1	Person is looking for another job	
			9	Not applicable (WSTATOR=3-5,9)	
LOOKREAS	77	YEARLY	blank	No answer <i>Main reason for looking for another job</i>	LOOKOJ = 1
			1	- risk or certainty of loss or termination of present job	
			2	- actual job is considered as a transitional job	
			3	- seeking an additional job to add more hours to those worked in present job	
			4	- seeking a job with more hours worked than in present job	
			5	- seeking a job with fewer hours worked than in present job	
			6	- wish to have better working conditions (e.g. pay, working or travel time, quality of work)	
			7	- of other reasons	
			9	Not applicable (LOOKOJ ≠ 1)	
			blank	No answer	
				SECOND JOB	
EXIST2J	78	QUARTERLY		<i>Existence of more than one job or business</i>	WSTATOR=1 or WSTATOR=2
			1	Person had only one job or business during the reference week	
			2	Person had more than one job or business during the reference week (not due to change of job or business)	
			9	Not applicable (WSTATOR=3-5,9)	
			blank	No answer	
STAPRO2J	79	QUARTERLY		<i>Professional status (in the second job)</i>	EXIST2J=2
			1	Self-employed with employees	
			2	Self-employed without employees	
			3	Employee	
			4	Family worker	
			9	Not applicable (EXIST2J=1,9 blank)	
			blank	No answer	
NACE2J2D	80/81	QUARTERLY		<i>Economic activity of the local unit (in the second job)</i>	EXIST2J=2
				NACE Rev. 2	
			00	Not applicable (EXIST2J=1,9,blank)	
			blank	No answer	
HWACTUA2	82/83	QUARTERLY		<i>Number of hours actually worked during the reference week in the second job</i>	EXIST2J=2
			00	Person not having worked in the second job during the reference week	
			01-98	Number of hours actually worked in the second job during the reference week	
			99	Not applicable (EXIST2J=1,9, blank)	
			blank	No answer	
				PREVIOUS WORK EXPERIENCE OF PERSON NOT IN EMPLOYMENT	
EXISTPR	84	QUARTERLY		<i>Existence of previous employment experience</i>	WSTATOR=3-5
			0	Person has never been in employment (purely occasional work, such as vacation work, compulsory military or community service are not to be considered as employment)	
			1	Person has already been in employment (purely	

Labour Force Survey - United Kingdom

YEARPR	85/88	QUARTERLY	9 blank	occasional work, such as vacation work, compulsory military or community service are not to be considered as employment) Not applicable (WSTATOR=1,2 or 9) No answer <i>Year in which person last worked</i> Enter the 4 digits of the year in which person last worked	EXISTPR=1
MONTHPR	89/90	QUARTERLY	9999 blank	Not applicable (EXISTPR=0,9,blank) No answer <i>Month in which person last worked</i> Enter the number of the month in which person last worked	YEARPR≠9999, blank & REFYEAR- YEARPR <= 2
LEAVREAS	91/92	YEARLY	01-12 99 blank	Not applicable (YEARPR=9999, blank or REFYEAR-YEARPR>2) No answer <i>Main reason for leaving last job or business</i>	EXISTPR=1 and REFYEAR - YEARPR<8
STAPROPR	93	QUARTERLY only if having worked in the last 12 months YEARLY otherwise	00 01 02 03 04 05 06 07 08 09 99 blank	Dismissed or made redundant A job of limited duration has ended Looking after children or incapacitated adults Other personal or family responsibilities Own illness or disability Education or training Early retirement Normal retirement Compulsory military or community service Other reasons Not applicable (EXISTPR=0,9,blank, or EXISTPR=1 and did not work in last 8 years) No answer <i>Professional status in last job</i>	EXISTPR=1 and REFYEAR - YEARPR<8
NACEPR2D	94/95	QUARTERLY if having worked in the last 12 months, YEARLY otherwise	1 2 3 4 9 blank	Self-employed with employees Self-employed without employees Employee Family worker Not applicable (EXISTPR=0,9,blank, or EXISTPR=1 and did not work in last 8 years) No answer <i>Economic activity of the local unit in which person last worked</i> NACE Rev. 2	EXISTPR=1 and REFYEAR - YEARPR<8
ISCOPR3D	96/98	QUARTERLY if having worked in the last 12 months, YEARLY otherwise	00 blank 999 blank	Not applicable (EXISTPR=0,9,blank, or EXISTPR=1 and did not work in last 8 years) No answer No answer <i>Occupation of last job</i> ISCO-88 (COM)	EXISTPR=1 and REFYEAR - YEARPR<8
SEEKWORK	99	QUARTERLY	1 2	SEARCH FOR EMPLOYMENT <i>Seeking employment during previous four weeks</i> Person has already found a job which will start within a period of at most 3 months Person has already found a job which will start in more than 3 months and is not seeking employment	(WSTATOR=3-5 or SIGNISAL=3) and Age<75

Labour Force Survey - United Kingdom

SEEKREAS	100	YEARLY	3 4 9	Person is not seeking employment and has not found any job to start later Person is seeking employment Not applicable (WSTATOR=1,2 or 9 and SIGNISAL ≠ 3) or Age equal or greater than 75	SEEKWORK=3
				<i>Reasons for not searching an employment</i> <i>Person is not seeking employment because:</i>	
			1 2 3 4 5 6 7 8 9	- awaiting recall to work (persons on lay-off) - of own illness or disability - looking after children or incapacitated adults - of other personal or family responsibilities - of education or training - of retirement - of belief that no work is available - of other reasons	
SEEKTYPE	101	QUARTERLY	9 blank	Not applicable (SEEKWORK≠3) No answer	
				<i>Type of employment sought (or found)</i> The employment sought (for SEEKWORK=1, 2 the employment found) is:	SEEKWORK=1, 2, 4 or LOOKOJ=1
			1 2 3 4 5 6 9	as self-employed as employee : - and only full-time job is looked for (or has already been found) - and full-time job is sought, but if not available, part-time job will be accepted - and part-time job is sought, but if not available, full-time job will be accepted - and only part-time job is looked for (or has already been found) - and person did not state whether full-time or part-time job is looked for (or has already been found)	
			9 Blank	Not applicable (SEEKWORK ≠ 1,2,4 and LOOKOJ ≠ 1) No answer	
SEEKDUR	102	QUARTERLY	Blank	No answer	
				<i>Duration of search for employment</i>	SEEKWORK=1, 4 or LOOKOJ=1
			0 1 2 3 4 5 6 7 8 9	Search not yet started Less than 1 month 1-2 months 3-5 months 6-11 months 12-17 months 18-23 months 24-47 months 4 years or longer	
			9 Blank	Not applicable (SEEKWORK ≠ 1,4 and LOOKOJ ≠ 1) No answer	
				METHODS USED DURING PREVIOUS FOUR WEEKS TO FIND WORK	
METHODA	103	QUARTERLY		<i>Contacted public employment office to find work</i>	SEEKWORK=4 or LOOKOJ=1
			0 1 9	No Yes Not applicable (SEEKWORK ≠ 4 and LOOKOJ ≠ 1)	
METHODB	104	QUARTERLY		<i>Contacted private employment agency to find work</i>	SEEKWORK=4 or LOOKOJ=1
			0 1 9	No Yes Not applicable (SEEKWORK ≠ 4 and LOOKOJ ≠ 1)	

Labour Force Survey - United Kingdom

METHODC	105	QUARTERLY	0 1 9	<i>Applied to employers directly</i> No Yes Not applicable (SEEKWORK ≠ 4 and LOOKOJ ≠ 1)	SEEKWORK=4 or LOOKOJ=1
METHODD	106	QUARTERLY	0 1 9	<i>Asked friends, relatives, trade unions, etc.</i> No Yes Not applicable (SEEKWORK ≠ 4 and LOOKOJ ≠ 1)	SEEKWORK=4 or LOOKOJ=1
METHODE	107	QUARTERLY	0 1 9	<i>Inserted or answered advertisements in newspapers or journals</i> No Yes Not applicable (SEEKWORK ≠ 4 and LOOKOJ ≠ 1)	SEEKWORK=4 or LOOKOJ=1
METHODF	108	QUARTERLY	0 1 9	<i>Studied advertisements in newspapers or journals</i> No Yes Not applicable (SEEKWORK ≠ 4 and LOOKOJ ≠ 1)	SEEKWORK=4 or LOOKOJ=1
METHODG	109	QUARTERLY	0 1 9	<i>Took a test, interview or examination</i> No Yes Not applicable (SEEKWORK ≠ 4 and LOOKOJ ≠ 1)	SEEKWORK=4 or LOOKOJ=1
METHODH	110	QUARTERLY	0 1 9	<i>Looked for land, premises or equipment</i> No Yes Not applicable (SEEKWORK ≠ 4 and LOOKOJ ≠ 1)	SEEKWORK=4 or LOOKOJ=1
METHODI	111	QUARTERLY	0 1 9	<i>Looked for permits, licences, financial resources</i> No Yes Not applicable (SEEKWORK ≠ 4 and LOOKOJ ≠ 1)	SEEKWORK=4 or LOOKOJ=1
METHODJ	112	QUARTERLY	0 1 9	<i>Awaiting the results of an application for a job</i> No Yes Not applicable (SEEKWORK ≠ 4 and LOOKOJ ≠ 1)	SEEKWORK=4 or LOOKOJ=1
METHODK	113	QUARTERLY	0 1 9	<i>Waiting for a call from a public employment office</i> No Yes Not applicable (SEEKWORK ≠ 4 and LOOKOJ ≠ 1)	SEEKWORK=4 or LOOKOJ=1
METHODL	114	QUARTERLY	0 1 9	<i>Awaiting the results of a competition for recruitment to the public sector</i> No Yes Not applicable (SEEKWORK ≠ 4 and LOOKOJ ≠ 1)	SEEKWORK=4 or LOOKOJ=1
METHODM	115	QUARTERLY	0 1 9	<i>Other method used</i> No Yes Not applicable (SEEKWORK ≠ 4 and LOOKOJ ≠ 1)	SEEKWORK=4 or LOOKOJ=1
WANTWORK	116	QUARTERLY	1 2	<i>Willingness to work for person not seeking employment</i> Person is not seeking employment: - but would nevertheless like to have work - and does not want to have work	SEEKWORK=3

Labour Force Survey - United Kingdom

AVAILBLE	117	QUARTERLY	9 Blank	Not applicable (SEEKWORK≠3) No answer	
				<i>Availability to start working within two weeks</i>	
				If work were found now:	
			1	Person could start to work immediately (within 2 weeks)	SEEKWORK=1, 4 or
			2	Person could not start to work immediately (within 2 weeks)	WANTWORK=1, blank or
			9	Not applicable (SEEKWORK≠1,4 and WANTWORK≠1,blank and WISHMORE≠1)	WISHMORE=1
AVAIRESAS	118	YEARLY	9 Blank	Not applicable (SEEKWORK≠1,4 and WANTWORK≠1,blank and WISHMORE≠1) No answer	
				<i>Reasons for not being available to start working within 2 weeks</i>	AVAILBLE=2
				Person could not start to work immediately (within 2 weeks) because:	
			1	- he/she must complete education or training	
			2	- he/she must complete compulsory military or community service	
			3	- he/she cannot leave present employment within two weeks due to period of notice	
			4	- of personal or family responsibilities (including maternity)	
			5	- of own illness or incapacity	
			6	- of other reasons	
			9	Not applicable (AVAILBLE≠2)	
PRESEEK	119	YEARLY	Blank	No answer	
				<i>Situation immediately before person started to seek employment (or was waiting for new job to start)</i>	SEEKWORK=1, 2, 4
			1	Person was working (including apprentices, trainees)	
			2	Person was in full-time education (excluding apprentices, trainees)	
			3	Person was conscript on compulsory military or community service	
			4	Person had domestic/family responsibilities	
			5	Other (e.g. retired)	
			9	Not applicable (SEEKWORK=3, 9)	
			Blank	No answer	
NEEDCARE	120	YEARLY	Blank	No answer	
				<i>Need for care facilities</i>	FTPTREAS=3 or SEEKREAS =3
				Person is not searching for a job or is working part time because:	
			1	suitable care services for children are not available or affordable	
			2	suitable care services for ill, disabled, elderly are not available or affordable	
			3	Suitable care services for both children and ill, disabled and elderly are not available or affordable.	
			4	Care facilities do not influence decision for working part time or not searching for a job	
			9	Not applicable (FTPTREAS≠3 and SEEKREAS ≠3)	
			Blank	No answer	
REGISTER	121	YEARLY	Blank	No answer	
				<i>Registration at a public employment office</i>	everybody aged 15 to 74 years
			1	Person is registered at a public employment office and receives benefit or assistance	
			2	Person is registered at a public employment office but does not receive benefit or assistance	
			3	Person is not registered at a public employment office but receives benefit or assistance	
			4	Person is not registered at a public employment office and does not receive benefit or assistance	
			9	Not applicable (person aged less than 15 years or older than 75)	
			Blank	No answer	

Labour Force Survey - United Kingdom

				MAIN LABOUR STATUS	
MAINSTAT (optional)	122	YEARLY	1 2 3 4 5 6 7 8 9 blank	<i>Main status</i> Carries out a job or profession, including unpaid work for a family business or holding, including an apprenticeship or paid traineeship, etc. Unemployed Pupil, student, further training, unpaid work experience In retirement or early retirement or has given up business Permanently disabled In compulsory military service Fulfilling domestic tasks Other inactive person Not applicable (child less than 15 years) No answer	everybody aged 15 years or more
EDUCSTAT	123	QUARTERLY	1 3 2 9 blank	EDUCATION AND TRAINING <i>Student or apprentice in regular education during the last four weeks</i> Has been a student or an apprentice Person in regular education but on holidays Has not been a student or apprentice Not applicable (child less than 15 years) No answer	everybody aged 15 years or more
EDUCLEVL	124	QUARTERLY	1 2 3 4 5 6 9 blank	<i>Level of this education or training</i> ISCED 1 ISCED 2 ISCED 3 ISCED 4 ISCED 5 ISCED 6 Not applicable (EDUCSTAT = 2, 9, blank) No answer	EDUCSTAT = 1 or 3
EDUCFILD (optional)	125/127	YEARLY	000 100 200 222 300 400 420 440 460 481 482 500 600 700 800 900 999 blank	<i>Field of this education or training</i> General programmes Teacher training and education science Humanities, languages and arts Foreign languages Social sciences, business and law Science, mathematics and computing Life science (including biology and environmental science) Physical science (including physics, chemistry and earth science) Mathematics and statistics Computer science Computer use Engineering, manufacturing and construction Agriculture and veterinary Health and welfare Services Unknown Not applicable (EDUCSTAT = 2, 9, blank or EDUCLEVL ≠ (3 to 6)) No answer	EDUCSTAT = 1 or 3 and EDUCLEVL = 3 to 6
COURATT	128	QUARTERLY		<i>Did you attend any courses, seminars, conferences or receive private lessons or instructions outside the regular education system (hereafter referred to as taught</i>	Everybody aged 15 years or more

Labour Force Survey - United Kingdom

			1	Yes	
			2	No	
			9	Not applicable (child less than 15 years)	
			blank	No answer	
COURLEN	129/131	QUARTERLY		<i>learning activities) within the last four weeks</i>	
				<i>Number of hours spent on all taught-learning activities within the last four weeks</i>	COURATT = 1
			3	Number of hours	
			digits		
			999	Not applicable (COURATT = 2, 9, blank)	
			blank	No answer	
COURPURP (optional)	132	YEARLY		<i>Purpose of the most recent taught learning activity</i>	COURATT = 1
			1	Mostly job related (professional)	
			2	Mostly personal/social	
			9	Not applicable (COURATT = 2, 9, blank)	
			blank	No answer	
COURFILD (optional)	133/135	YEARLY		<i>Field of the most recent taught learning activity</i>	COURATT = 1
			000	General programmes	
			100	Teacher training and education science	
			200	Humanities, languages and arts	
			222	Foreign languages	
			300	Social sciences, business and law	
			400	Science, mathematics and computing	
			420	Life science (including biology and environmental science)	
			440	Physical science (including physics, chemistry and earth science)	
			460	Mathematics and statistics	
			481	Computer science	
			482	Computer use	
			500	Engineering, manufacturing and construction	
			600	Agriculture and veterinary	
			700	Health and welfare	
			800	Services	
			900	Unknown	
			999	Not applicable (COURATT = 2, 9, blank)	
			blank	No answer	
COURWORH (optional)	136	YEARLY		<i>Did the most recent taught learning activity take place during paid working hours?</i>	COURATT = 1
			1	Only during paid working hours	
			2	Mostly during paid working hours	
			3	Mostly outside paid working hours	
			4	Only outside paid working hours	
			5	No job at that time	
			9	Not applicable (COURATT = 2, 9, blank)	
			blank	No answer	
HATLEVEL	137/138	QUARTERLY		<i>Highest level of education or training successfully completed</i>	Everybody aged 15 years or more
			00	No formal education or below ISCED 1	
			11	ISCED 1	
			21	ISCED 2	
			22	ISCED 3c (shorter than two years)	
			31	ISCED 3c (two years and more)	
			32	ISCED 3 a, b	
			30	ISCED 3 (without distinction a, b or c possible, 2 y+)	

Labour Force Survey - United Kingdom

			41	ISCED 4a, b	
			42	ISCED 4c	
			43	ISCED 4 (without distinction a, b or c possible)	
			51	ISCED 5b	
			52	ISCED 5a	
			60	ISCED 6	
			99	Not applicable (child less than 15 years)	
			Blank	No answer	
HATFIELD	139/141	YEARLY		<i>Field of highest level of education or training successfully completed</i>	HATLEVEL = 22 to 60
			000	General programmes ⁴	
			100	Teacher training and education science ¹	
			200	Humanities, languages and arts ¹	
			222	Foreign languages ¹	
			300	Social sciences, business and law ¹	
			400	Science, mathematics and computing ¹	
			420	Life science (including biology and environmental science) ¹	
			440	Physical science (including physics, chemistry and earth science) ¹	
			460	Mathematics and statistics ¹	
			481	Computer science	
			482	Computer use	
			500	Engineering, manufacturing and construction ¹	
			600	Agriculture and veterinary ¹	
			700	Health and welfare ¹	
			800	Services ¹	
			900	Unknown	
			999	Not applicable (HATLEVEL = 00, 11, 21, 99, Blank)	
			blank	No answer	
HATYEAR	142/145	YEARLY		<i>Year when highest level of education or training was successfully completed</i>	HATLEVEL = 11-60
				The 4 digits of year when highest level of education or training was successfully completed are entered	
			9999	Not applicable (HATLEVEL = 00, 99, blank)	
			blank	No answer	
				SITUATION ONE YEAR BEFORE SURVEY	
WSTAT1Y	146	YEARLY		<i>Situation with regard to activity one year before survey</i>	everybody aged 15 years or more
			1	Carries out a job or profession, including unpaid work for a family business or holding, including an apprenticeship or paid traineeship, etc,	
			2	Unemployed	
			3	Pupil, student, further training, unpaid work experience	
			4	In retirement or early retirement or has given up business	
			5	Permanently disabled	
			6	In compulsory military service	
			7	Fulfilling domestic tasks	
			8	Other inactive person	
			9	Not applicable (child less than 15 years)	
			blank	No answer	
STAPRO1Y	147	YEARLY		<i>Professional status one year before survey</i>	WSTAT1Y=1
			1	Self-employed with employees	
			2	Self-employed without employees	

⁴ Or subdivisions of ISCED 1997 – field of education – coded on 3 digits

Labour Force Survey - United Kingdom

NACE1Y2D	148/149	YEARLY	3 4 9 blank	Employee Family-worker Not applicable (WSTAT1Y≠1) No answer <i>Economic activity of local unit in which person was working one year before survey</i> NACE Rev. 2	WSTAT1Y=1
			00 blank	Not applicable (WSTAT1Y≠1) No answer	
COUNTRY1Y	150/151	YEARLY		<i>Country of residence one year before survey</i> For coding, see ISO country classification	Everybody aged 1 year or more
			99 blank	Not applicable (child less than one year old) No answer	
REGION1Y	152/153	YEARLY		<i>Region of residence one year before survey</i> NUTS 2	Everybody aged 1 year or more
			99 blank	Not applicable (person who has changed country of residence or child less than one year old) No answer	
INCDECIL	154/155	YEARLY		INCOME Monthly (take home) pay from main job	STAPRO=3
			01-10 99 Blank	Deciles order Not applicable (STAPRO ≠ 3) No answer	
REFYEAR	156/159	QUARTERLY		TECHNICAL ITEMS RELATING TO THE INTERVIEW <i>Year of survey</i>	everybody
				Last 4 digits of the year	
REFWEEK	160/161	QUARTERLY		<i>Reference week</i> Number of the week running from Monday to Sunday	everybody
INTWEEK	162/163	QUARTERLY		<i>Interview week</i> Number of the week running from Monday to Sunday	everybody
COUNTRY	164/165	QUARTERLY		<i>Country</i> For coding, see ISO country classification (Annex IV)	everybody
REGION	166/167	QUARTERLY		<i>Region of household</i> NUTS 2	everybody
DEGURBA	168	QUARTERLY		<i>Degree of urbanisation</i>	everybody
			1 2 3	Densely-populated area Intermediate area Thinly-populated area	
HHNUM	169/174	QUARTERLY		<i>Serial number of household</i> Serial numbers are allocated by the national statistical institutes and remain the same for all waves. Records relating to different members of the same household carry the same serial number	everybody
HHTYPE	175	QUARTERLY		<i>Type of household</i>	everybody
			1 2 3	Person living in private household (or permanently in a hotel) and surveyed in this household Person living in an institution and surveyed in this institution Person living in an institution but surveyed in this private household	

Labour Force Survey - United Kingdom

HHINST	176	QUARTERLY	4	Person living in another private household on the territory of the country but surveyed in this household of origin	HHTYPE =2,3
				<i>Type of institution</i>	
			1	Educational institution	
			2	Hospital	
			3	Other welfare institution	
			4	Religious institution (not already included in 1-3)	
			5	Workers' hostel, working quarters at building sites, student hostel, university accommodation, etc.	
			6	Military establishment	
			7	Other (e.g. prison)	
			9	Not applicable (HHTYPE =1,4)	
COEFFY	177/182	YEARLY	blank	No answer	everybody
				<i>Yearly weighting factor</i>	
			0000-9999	Cols 177-180 contain whole numbers	
			00-99	Cols 181-182 contain decimal places	
COEFFQ	183/188	QUARTERLY		<i>Quarterly weighting factor</i>	everybody
			0000-9999	Cols 183-186 contain whole numbers	
			00-99	Cols 187-188 contain decimal places	
				<i>Yearly weighting factor of the sample for household characteristics (in the case of a sample of individuals)</i>	
COEFFH	189/194	YEARLY	0000-9999	Cols 189-192 contain whole numbers	everybody
			00-99	Cols 193-194 contain decimal places	
				<i>Sequence number of the survey wave</i>	
			1-8	Sequence number of the wave	
INTWAVE	195	QUARTERLY		<i>Questionnaire used</i>	everybody
			1	Only core variables	
			2	Whole questionnaire	

Section 7:

EXPLANATORY NOTES TO THE LFS LIST OF VARIABLES

Demographic background

Col 1/2: (HHSEQNUM) Sequence number within household

A two-digit sequence number should be allocated to each member of the household. It should remain the same for all waves. Persons re-entering the household should retain the original sequence number.

Col 3: (HHLINK) Relationship to reference person in the household

Code 1: Each private household should contain one and only one person coded as 'reference person', who must be a person aged 15 and over.

Code 2 should reflect the “de facto” situation in terms of co-habitation arrangements. It therefore does not necessarily correspond with the “de jure” situation of the household in terms of co-habitation arrangements, as recorded in Col 16 (*Marital status*).

Code 3 should not include sons and daughters in law, who should be coded 5.

Code 4 means the father or the mother of the reference person or of his/her cohabiting partner.

Col 4/5: (HHSPOU) Sequence number of spouse or cohabiting partner

The identification should be done using the sequence number which was allocated to these persons in Col 1/2 (*Sequence number in the household*).

It should reflect the “de facto” situation in terms of co-habitation arrangements. It therefore does not necessarily correspond with the “de jure” situation of the household in terms of co-habitation arrangements, as recorded in Col. 16 (*Marital status*).

Col 6/7: (HHFATH) Sequence number of father

The identification should be done using the sequence number which was allocated to these persons in Col 1/2 (*Sequence number in the household*).

No distinction should be made between biological and non-biological children in the case of adopted children or step children. Father and mother in law should be coded 99.

In case of homoparentality (parents of the same sex) the sequence number of the parents should appear in Col 6/7 and Col 8/9.

Col 8/9: (HHMOTH) Sequence number of mother

The identification should be done using the sequence number which was allocated to these persons in Col 1/2 (*Sequence number in the household*).

No distinction should be made between biological and non-biological children in the case of adopted children or step children. Father and mother in law should be coded 99.

In case of homoparentality (parents of the same sex) the sequence number of the parents should appear in Col 6/7 and Col 8/9.

Col 11/14: (YEARBIR) Year of birth

In case the respondent does not know the exact date of birth (e.g. in case of a proxy) or refuses to answer this question, an estimate should be provided.

Col 15: (DATEBIR) Date of birth in relation to the end of reference period

For persons born in the same year, those coded 1 (birthday falling between 1 January and the end of the reference week) will be, for the purpose of analysing survey results, effectively one year older than those persons coded 2 (birthday falling after the end of the reference week). This definition of age should be applied in all filters that use age.

Col 16: (MARSTAT) Marital status

Marital status is the conjugal status of each individual in relation to the marriage laws of the country (i.e. de jure status). It therefore does not necessarily correspond with the actual situation of the household in terms of co-habitation arrangements, as recorded in Col 3.

In case of borderline situations, e.g., trial separations, or registered cohabitation bestowing some but not full marital rights or duties, the prevailing national statistical convention should apply.

Some countries have a legal framework for registering partnerships (in most countries these are same-sex partnership and they have a legal status parallel to married couples). Such information has also to be treated in a harmonised way so they should be treated as married and classified under group 2 when the partnership still exists, else as 3-4 as appropriate (legal separation or death of one of the partners).

In some countries, children under a certain age cannot have a legal marital status different from "single". To ask them this question would not be necessary, nevertheless they should be coded 1.

Col 17/18: (NATIONAL) Nationality

See country classification in Annex IV (derived from ISO)

Nationality should be interpreted as citizenship. Citizenship is defined as the particular legal bond between an individual and his/her State acquired by birth or naturalisation, whether by declaration, option, marriage or other means according to national legislation. It corresponds to the country issuing the passport.

The concept of nationality should not be mixed up with any concept of ethnic origin. For persons with dual or multiple citizenships, and who hold the citizenship of the country of residence, that citizenship should be coded.

This should be provided according to the coding given in Annex IV. If possible the exact country should be indicated; where this is not possible, one of the general groupings in bold print should be used. EU and EFTA Member States but also candidate and other European countries must be coded individually.

In case of multiple citizenship, including one citizenship of a member state of the European Union, that citizenship should be coded. In other situations the first answer of the respondent should be coded.

This should be provided according to the coding given in Annex IV. If possible the exact country should be indicated; where this is not possible, one of the general

groupings in bold print should be used. EU and EFTA Member States but also candidate and other European countries must be coded individually.

Col 19/20: (YEARESID) Years of residence in this country for persons not born in the country

The years of residence should be calculated taking as starting point the year in which the person last established his or her usual residence in the country (or, in other words, when the person last moved to the country in order to live there).

In case of an interruption in the period of residence, the starting point should be the end of this interruption only if the length of this interruption was at least one year.

For persons with less than one year's residence in this Member State, 01 should be coded; between one year and less than two years, 02; and so on. Up to 2007, people with 10 years of residence and more were coded 11. This is no longer the case from 2008 onwards.

Col 21/22: (COUNTRYB) Country of birth

In case of doubt, the country of birth should be defined as the country of residence of the mother at the time of birth. This definition could help to identify cases where the person was born abroad in exceptional circumstances.

For the purpose of this question, current national boundaries should be considered, rather than any applying at the time of the respondent's birth.

This should be provided according to the coding given in Annex IV. If possible the exact country should be indicated; where this is not possible, one of the general groupings in bold print should be used. European States must be coded individually.

Col 23: (PROXY) Nature of participation in the survey

Code 1 includes all cases where the person is responding directly, even with the assistance of a third person (e.g. interpreter).

Labour status

Col 24: (WSTATOR) Labour status during the reference week

Information provided here determines whether a person is considered as being in employment or not, following the guidelines of International Labour Organisation (ILO). Persons in employment are those coded 1 or 2.

Code 1: Did any work for pay or profit during the reference week

"Work" means any work for pay or profit during the reference week, even for as little as one hour. Pay includes cash payments or "payment in kind" (payment in goods or services rather than money), whether payment was received in the week the work was done or not. Also counted as working is anyone who receives wages for on-the-job training which involves the production of goods or services. Self-employed persons with a business, farm or professional practice are also considered to be working if one of the following applies:

- (i) A person works in his own business, professional practice or farm for the purpose of earning a profit, even if the enterprise is failing to make a profit.
- (ii) A person spends time on the operation of a business, professional practice or farm even if no sales were made, no professional services were rendered, or

nothing was actually produced (for example, a farmer who engages in farm maintenance activities; an architect who spends time waiting for clients in his/her office; a fisherman who repairs his boat or nets for future operations; a person who attends a convention or seminar).

- (iii) A person considered as self-employed is in the process of setting up a business, farm or professional practice; this includes the buying or installing of equipment, and ordering of supplies in preparation for opening a new business.

Unpaid family workers: Persons working in a family business or on a family farm without pay should be living in the same household as the owner of the business or farm, or in a slightly broader interpretation, in a house located on the same plot of land and with common household interests. Such people frequently receive remuneration in the form of fringe benefits and payments in kind. However, this applies *only* when the business is owned or operated by the individual themselves or by a relative. Thus, unpaid voluntary work done for charity should *not* be included.

The category includes:

- A son or daughter living inside the household and working in the parents' business or on the parents' farm without pay.
- A wife who assists her husband in his business, e.g. a haulage contractor, without receiving any formal pay.

Persons who work on their own agriculture farm should be considered as employed (code 1 if he worked during the reference week, otherwise code 2) only in case at least part of their production is sold, whichever the total amount of the products. What is considered here is the usual destination of the production, and not whether a sale took place in the reference week. A person who worked in agricultural production during the reference week, did not sale anything because harvesting will take place in few weeks or months, should be consider as having worked for pay or profit in the reference week (code 1). Persons who work on their own small agriculture farm, who do not sell their products, and produce only for their own consumption should not be considered as employed (code 5).

Persons who are obliged to perform some work to keep receiving unemployment benefits
In some countries, unemployed (under special circumstances) have to perform some work to keep receiving the unemployment allowances. If they have performed some work during the reference week, they should be coded 1.

Persons who are building a house

If a person is building a house in order to earn a future financial profit (renting or selling it), he should be considered as employed (code 1 if he worked during the reference week, otherwise code 2). Building a house for only a family use is not enough to be considered as employed.

Conscripts performing some work for pay or profit during the reference week should always be coded 4.

Persons in paid employment who were on training during the whole reference week should be coded 1 if one of the three following statements is true:

- the participation of the employee is required by the employer
- the training takes place inside normal working hours
- the training is directly connected to the current job

Code 2: Was not working but had a job or business from which he/she was absent during the reference week

In general, the notion of temporary absence from work refers to situations in which a period of work is interrupted by a period of absence. This implies that persons are generally to be considered as having been temporarily absent from work and therefore employed, if they had already worked at their current activity and were expected to return to their work after the period of absence. Persons without work who had made arrangements to take up paid employment or to engage in some self-employment activity at a date subsequent to the reference period, but who had not yet started work, are not to be considered as temporarily absent from work.

For employees

A job exists if there is a definite and pre-scheduled arrangement between an employer and employee for regular work (that is, every week or every month), whether the work is full-time or part-time. The number of hours of work done each week or each month may vary considerably, but as long as some work is done on a regular and scheduled basis, a job is considered to exist.

In the case of employees, a person absent from work should be considered as employed if there is a formal attachment to the job, for example if at least one of the following criteria is fulfilled:

- the continued receipt of wage or salary, and an assurance of a return to work (or an agreement as to the date of return) following the end of the contingency..
- the elapsed duration of absence from the job which, wherever relevant, may be that duration for which workers can receive compensation benefits without obligation to accept other jobs.

Seasonal workers

During the off-season, seasonal workers cannot be considered as having a formal attachment to their high-season job if they have an assurance to come back to work with the same employer at the beginning of the next season and the employer continues to pay at least 50% of their wage or salary during the off-season. In this case they have to be coded 2 during the off-season. In other cases, they have to be considered as not employed (code 5).

Maternity and paternity leave

Maternity leave is first given to the mother (but may include the leave of the father in the case of a transfer of the entitlements) and corresponds to the compulsory or statutory period of the leave stipulated by national legislation to ensure that mothers before and after childbirth have sufficient rest, or for a period to be specified according to national circumstances.

People on maternity leave should always be coded 2 in Col 24. Paternity leave is also included under this code.

For unpaid family workers

The unpaid family worker can be said to have a job but not be at work if there is a definite commitment by the employer (a related household member) to accept his/her return to work and the total absence do not exceed a period of 3 months. In this point

EuroStat diverges from the ILO recommendation. If the period of absence exceeds 3 months they should be coded 5 in Col 24.

For self-employed persons

If self-employed persons are classified as being absent from work, then they are regarded as in employment only if they can be said to have a business, farm or professional practice. This is the case if one or more of the following conditions are met:

- (i) Machinery or equipment of significant value, in which the person has invested money, is used by him or his employees in conducting his business.
- (ii) An office, store, farm or other place of business is maintained.
- (iii) There has been some advertisement of the business or profession by listing the business in the telephone book, displaying a sign, distributing cards or leaflets, etc.

If none of these conditions is met, then the person is regarded as not being in employment and therefore should be coded 5 in Col 24.

Code 3: Was not working because on lay-off.

A person on lay-off is one whose written or unwritten contract of employment, or activity, has been suspended by the employer for a specified or unspecified period at the end of which the person concerned has a recognised right or recognised expectation to recover employment with that employer.

Lay-offs are classified as employed if they have an assurance of return to work within a period of 3 months or receive $\geq 50\%$ of their wage or salary from their employer.

Lay-offs are classified as unemployed if they receive less than 50% of their wage or salary from their employer, don't have assurance of return to work or have an agreed date but this date falls after a period of 3 months and if they are "available to start work in 2 weeks" and have "actively searched for a job in the last 4 weeks".

Otherwise they are considered as inactive.

In case respondents can't say if they receive more or less than 50% of the salary and if they don't have an assurance of return to work within a period of 3 months the code 3 should be used.

Persons without employment during the reference week but who have found a job to start in the future should always be coded 5 in this column.

Col 25/26: (NOWKREAS) Reason for not having worked at all although having a job

Code only one reason. If the respondent gives more than one reason, code the one that explains the greatest number of hours away from work.

Code 01: This includes difficulties such as plant breakdown or materials shortage; see also note below on Code 02. A person in slack work for technical or economic reasons should have a formal attachment to his/her job.

Code 02: This code only applies to persons who were directly involved in a labour dispute. Other persons who did not work because production in the establishment was

impeded by a labour dispute outside the establishment (thus causing a shortage in material supplies for example) are coded 01.

Code 03: It refers to all kind of school education or training, inside or outside the workplace.

Code 05: Maternity leave corresponds to the compulsory or statutory period of the leave stipulated by national legislation to ensure that mothers before and after childbirth have sufficient rest, or for a period to be specified according to national circumstances. Paternity leave is also included under this code.

Code 06: Parental leave can be taken either by the mother or the father and is the interruption of work to bring up a child of young age. This code is used only for those persons on statutory parental leave (legal or contractual). Any other leave taken for reasons of child-bearing or rearing is coded 09.

Code 08: This code includes all absences that are related to working time flexibility. Examples are time off as a compensation of overtime, as a compensation of credit hours within a system of working time banking or within the framework of an annualised hours contract (This category is a parallel to code 07 in Column 69/70). Cases of people who work full-time one week, and not at all the following week are included here.

Employment characteristics of main job

Col 27: (STAPRO) Professional status

The professional status requested here refers to the main job. For the purposes of Col. 27 to 77, multiple job holders decide for themselves which job is to be considered as the first job. In doubtful cases, the first job should be the one with the greatest number of hours usually worked. Persons having changed jobs during the reference week should regard the job held at the end of the reference week as their main job.

Code 1: Self-employed with employees

If people working in the business, professional practice or farm, are not paid then he/she should be considered as self employed without staff.

Code 2: Self-employed without employees

People who engage members of his/her own family or apprentices without payment should be classified in code 2. In this category one can find farmers working alone or using the assistance of members of family.

A person who looks after one or more children that are not his/her own on a private basis and receiving a payment for this service should be considered as self-employed, except when he/she works for a single employer and receives employment rights from that employer (e.g. holiday pay) he/she should be classified as an employee (code 3).

A freelancer should in general be classified as self-employed. However in situations where freelancer works for a single employer and receives employment rights from that employer (e.g. holiday pay) he should be classified as an employee (code 3).

A person who gives private lessons should be considered as self-employed if he/she is directly paid by his/her students.

Members of producers' co-operatives should be considered as self-employed. In the case co-operative hired workers and these workers have an employment contract that gives them a basic remuneration (which is not directly dependent upon the revenue of the co-operative), these workers are identified as employees of the co-operative. Even if the co-operative has employees (e.g. an accountant) the members of the co-operative should be considered as "self-employed without employees" because the co-operative as an institution (and not any of its members) is the employer.

Code 3: Employee

An employee is usually working for an outside employer, but a son or daughter, for example, who is working in a parent's firm and receives a regular monetary wage is classified here as an employee.

A person looking after children in his/her own home is classified as an employee if he/she is paid to do this by the local authority (or any other public administration) and if he/she doesn't take any decision affecting the enterprise (e.g. schedules or number of children) but should be classified as self-employed if he/she does it privately (code 2).

Apprentices or trainees receiving remuneration should be considered as employees.

Priests (of any kind of religion) are considered employees

Code 4: Family worker

Persons working in a family business or on a family farm without pay should be living in the same household as the owner of the business or farm, or in a slightly broader interpretation, in a house located on the same plot of land and with common household interests. Such people frequently receive remuneration in the form of fringe benefits and payments in kind. However, this applies *only* when the business is owned or operated by the individual themselves or by a relative. Thus, unpaid voluntary work done for charity should *not* be included.

The category includes:

- A son or daughter living inside the household and working in the parents' business or on the parents' farm without pay.
- A wife who assists her husband in his business, e.g. a haulage contractor, without receiving any formal pay.

The category does not include:

- A relative living elsewhere but coming to help with the business, e.g. during the harvesting season, without pay in money or kind should not be included. If the relative receives any remuneration (including benefits in kind) the professional status should be coded as 3 (Employee).

Col 28: (SIGNISAL) Continuous receipt of the wage or salary

The total duration of the absence should be calculated. If the person does not know the total duration, it should be calculated as the elapsed time between the moment the person last worked and the end of the reference week.

The salary to be considered in this variable is the current salary from the main job and net salary should be preferred unless gross salary is easier to collect. Salary can be paid by the employer or by the social security (or both). It includes any compensation

of wages (e.g. parental leave allowance linked to the job) but excludes any other benefit which the person would receive even without a job (e.g. family allowances).

The main target groups for this variable are the persons in long term absences:

- the parental leave
- the paid or unpaid leave initiated by the employer or the administration
- the educational or training leave
- other kinds of career breaks

Col 29/31: (NACE3D) Economic activity of the local unit

The local unit is an enterprise or part thereof (e.g. a workshop, factory, warehouse, office, mine or depot) situated in a geographically identified place. At or from this place economic activity is carried out for which one or more persons work (even if only part-time) for one and the same enterprise.

The NACE codes in Annex II are derived from the Statistical Classification of Economic Activities.

If a person works in more than one place (transport, construction, maintenance, surveillance, peripatetic work...) or at home, or in the consumer's place (e.g. surveillance, security, cleaning ...), the local unit is taken to be the place from where instructions emanate or from where the work is organised.

The economic activity of the local unit for persons with a contract with a temporary employment agency should be coded as the activity of the local unit where they actually work and not in the industry of the agency which employs them.

For those countries that are not able to provide information at a 3 digit level the third digit should be coded '0'.

Col 32/35: (ISCO4D) Occupation

This should be coded according to the classification provided in Annex III.

For those countries that are not able to provide information at a 4 digit level the fourth digit should be coded '0'.

Col 36: (SUPERVISOR) Supervisory responsibilities

A person is considered to have supervisory responsibilities when they supervise the work of at least one (other) person. He/she takes charge of the work of other employees, directs their work and sees that is satisfactorily carried out.

Supervisory responsibility includes formal responsibility for directing other employees (other than apprentices), whom they supervise directly, sometimes doing some of the work they supervise and excludes quality control (check output of services but not the work produced by other persons) and consultancy.

It should be considered the usual situation and not the situation only during the reference week.

Sometimes job titles can be misleading. For example, a 'playground supervisor' supervises children not employees and so should be coded 2. Similarly, a 'store manager' may be a storekeeper and not a supervisor of employees.

In some cases the person is cumulating supervising responsibilities with other functions; even if the supervising responsibilities only constitute a part of their job, they should be coded 1.

Persons having supervisory responsibilities only because they are temporarily replacing an absent superior should not be considered as having supervisory responsibilities. The definition of temporarily here is left to the respondent.

Members of groups with Collective responsibility (groups where there is a rotating leadership in a continuous way taking charge of the work of other employees, directing their work and seeing that is satisfactorily carried out) should be considered as having supervisory responsibilities.

Col 37/38: (SIZEFIRM) Number of persons working at the local unit

The number of persons working at the local unit is defined as the total number of persons who work inside the unit (inclusive of working proprietors, partners working regularly in the unit and unpaid family workers), as well as persons who work outside the unit who belong to it and are paid by it (e.g. sales representatives, delivery personnel, repair and maintenance teams). It includes persons absent for a short period (e.g. sick leave, paid leave or special leave), and also those on strike, but not those absent for an infinite period. It also includes part-time workers who are regarded as such under the laws of the country concerned and who are on the payroll, as well as seasonal workers, apprentices and home workers on the payroll (definition of the regulation on Structural Business Surveys).

For the term "local unit", see notes to Col 29/31 (*Economic activity of the local unit*). The codes provided permit either an exact number to be indicated for units with 10 people or less (codes 01-10), broad classes for units with more than 10 (codes 11-13), or simply an indication of whether it is greater or less than ten (codes 14 and 15).

This variable should reflect the current situation but including people temporarily absent. The interviewed person should be included as well.

The number of persons employed should exclude manpower supplied to the unit by other enterprises, persons carrying out repair and maintenance work in the enquiry unit on behalf of other enterprises, as well as those on compulsory military service.

For pragmatic reasons, persons working for a temporary employment agency should provide the numbers of persons working in the local unit where they perform their work.

Codes 14 and 15 should only be used in case 1-13 cannot be coded.

Col 39/40: (COUNTRYW) Country of place of work

This should be provided according to the coding shown in Annex IV. If possible the exact country should be indicated; where this is not possible, one of the general groupings in bold print should be used. Member States must be coded individually.

If you have varied places of work, the country of work is the one where the local unit is settled.

Person working in embassies should be coded as working in the host country.

Col 41/42: (REGIONW) Region of place of work

This should be provided according to the coding system in Annex I, which is based upon the Classification of Territorial Units (NUTS).

Col 43/46 & Col 47/48: (YSTARTWK & MSTARTWK) Year/Month in which person started working for this employer or as self-employed in their current occupation

Renewed contracts

If a respondent has a contract that is renewed, for example yearly, without interruption, the year and the month should be those of the first contract. If there is a legal obligation that an interruption for a certain period of time is necessary before the renewal, this should nonetheless be considered as renewal (and not as a separate spell).

Separate spells of employment

For employees, we are interested in continuous employment with their current employer. Any previous separate spells of work with their current employer with an interruption of the contract should be ignored. The year which the person started the most recent spell should be coded (e.g. seasonal workers).

Company changed ownership

If the respondent's company or firm changed ownership, but his or her conditions of employment did not change, it should be treated as one continuous period of employment. However, if the respondent was made redundant and then re-employed by the new owners, enter the date on which they were re-employed.

Employment agencies

People employed by employment agencies should answer when they started working continuously for this employment agency (despite the fact that in the case of temporary workers the branch of economic activity and the staff category should be based on the current local unit).

Secondment

An employee who has been seconded to another organisation (public or private) should be treated as having no break in employment, IF they have signed a contract that is exactly the same as their existing contract.

Self-employment

For the self-employed make it clear that we are interested in the length of time the respondent has been continuously self employed in the occupation of his current main job.

Col 49: (WAYJFOUN) Involvement of the public employment office at any moment in finding the present job

The involvement of the public employment office should be effective, i.e. having contributed to the finding of the current job. It should be a role of putting in contact the employer and the employee by informing one of the existence of the other. "Putting in contact" should be interpreted broadly, and could simply involve the respondent seeing a job vacancy on the website of the employment office.

Jobs found through the home page of the public employment office have also to be coded as 1.

When the action of public employment office is only to send the person to training courses or any other activities that improve the skills of job searchers and which had allowed the person to take this job, without putting the person in contact with his current employer, then the code 0 applies.

Col 50: (FTPT) Full-time/Part-time distinction

This variable refers to the main job. A part-time worker is “an employed person whose normal hours of work are less than those of comparable full-time workers” (International Labour Conference, 81st session, 1994).

The distinction between full-time and part-time work should be made on the basis of a spontaneous answer given by the respondent. It is impossible to establish a more exact distinction between part-time and full-time work, due to variations in working hours between Member States and also between branches of industry.

Col 51: (FTPTREAS) Reasons for part-time work

The current main reason for working part-time should be coded.

Code 3: Care includes all care responsibilities:

- For own children or spouse children living inside or outside the household
- For other children (up to 14) living inside or outside the household
- For adult ill/elderly/incapacitated/disabled relatives/friends (aged 15 or more)

But excludes:

- Care as a job (it means that care done in a professional capacity is excluded).
- Care as a volunteer work (e.g. for a charity organisation)

In both cases, they should be coded as 6.

Col 52: (TEMP) Permanency of the job

Employees with a limited duration job/contract (code 2) are employees whose main job will terminate either after a period fixed in advance, or after a period not known in advance, but nevertheless defined by objective criteria, such as the completion of an assignment or the period of absence of an employee temporarily replaced.

Code 2 includes:

- Persons with a seasonal job
- persons engaged by a temporary employment agency or business and hired out to a third party for the carrying out of a "work mission" (unless there is a work contract of unlimited duration with the employment agency or business)
- Persons with specific training contracts.

What is involved is the actual employment being time-limited under an agreement - not that he/she has, for example, considered stopping work in order to travel or attend College.

Respondents who have a contract to do their job, which is expected to be renewed, for example, once a year, should be coded according to whether or not the respondents themselves consider their job to be of an unlimited duration.

A person having a contract for a probationary period should be coded 2 (see definition of probationary period in the explanatory note of col 53 (*Reasons for having a temporary job/work contract of limited duration*)).

In case of secondment from a permanent job, the person should be considered as having a contract of unlimited duration, if the person has an assurance to go back to his previous job.

Col 53: (TEMPREAS) Reasons for having a temporary job/work contract of limited duration
The probationary period is part of a selection process during which an employee new to a job is required to demonstrate fitness for the job by actual performance of the job's duties.

In the case where more than one category applies temporary work in relationship with a period of training or trial period (Col. 53= 1 or 4) are priority reasons for a temporary job.

The current reason of having a temporary job should be coded, even if it differs from the starting reason.

Col 54: (TEMPDUR) Total duration of temporary job or work contract of limited duration
This refers to the total of the time already elapsed plus the time remaining until the end of the current contract.

Code 2 should be interpreted as 1 month to less than 4 months, code 3 as 4 to less than 7 months and so on.

Persons who have a contract to perform a task should be prompted for a best estimate for how long it would take.

Respondents who have a contract to do their job, which is renewed, for example, once a year, should be coded referring to the current contract.

Col 55: (TEMPAGCY) Contract with a temporary employment agency
A temporary employment agency is a firm which places workers with whom it has entered contracts of employment at the temporary disposal of user firms.

Work for a temporary employment agency involves a triangular employment relationship between an employee who is paid by the employment agency but performs work for and under the supervision of a user enterprise.

Staff leasing is excluded here; staff leasing applies in the case when the type of expert knowledge or experience needed by the user enterprise is matched by the economic activity of the service provider. The service provider has not a general intermediary function on the labour market.

Staff working directly for the temporary employment agency (administrative tasks), i.e. not employed to perform any work for and under the supervision of a user enterprise, should be coded 0.

Persons employed by an agency to perform work for and under the supervision of a user enterprise, but not performing any work during the reference week for and under the supervision of a user enterprise and who are asked to perform administrative or

other tasks for the agency should anyway be coded as working for a temporary employment agency because this situation do not correspond to their usual situation. If a country has this information from other sources this variable can be imputed and the information does not have to be collected by interview.

The "Economic activity of the local unit" (NACE3D) for persons with a contract with a temporary employment agency should be coded as the activity of the enterprise where they actually work and not in the industry of the agency which employs them.

Atypical work

Col 56: (SHIFTWK) Shift work

"Shift work" means any method of organising work in shifts whereby workers succeed each other at the same work stations according to a certain pattern, including a rotating pattern, and which may be continuous or discontinuous, entailing the need for workers to work at different times over a given period of days or weeks (definition of the directive 2003/88/EC).

Shift work usually involves work on unsocial hours in the early morning, at night or in the weekend and the weekly rest days do not always coincide with the normal rest days.

Shift work should imply changes in the working schedule. Persons having fixed assignment to a given shift should not be considered as shift-workers, even if their working schedules are defined in their establishment in terms of shift work.

Col 57: (EVENWK) Evening work

The definitions of evening and night vary considerably so that it is not easy to establish a strictly common basis for all Member States. Generally speaking, however, "evening work" must be considered to be work done after the usual hours of working time in this Member State, but before the usual sleeping hours. This implies the possibility of sleeping at normal times (whereas "night work" implies an abnormal sleeping pattern).

Code 1: "Usually" in this context should be interpreted to mean:

- for self-employed, working during the evenings at least half of the days worked in a reference period of four weeks preceding the end of the reference week.
- for employees, having a formal working time arrangement to work in the evenings and working during the evenings at least half of the days worked in a reference period of four weeks preceding the end of the reference week.

Code 2: "Sometimes" in this context should be interpreted to mean:

- for self-employed, working during the evenings less than half of the days worked, but at least in one occasion in a reference period of four weeks preceding the end of the reference week.
- for employees, having a formal working time arrangement to work in the evenings and working during the evenings less than half of the days worked in a reference period of four weeks preceding the end of the reference week.

Code 3: "Never" in this context should be interpreted to mean:

- for self-employed, working during the evenings on no occasion in a reference period of four weeks preceding the end of reference week.
- for employees, having no formal working arrangement to work in the evening.

Col 58: (NIGHTWK) Night work

Bearing in mind the definitional problems discussed under Col 57 (Evening work), "night work" must be generally considered to be work done during the usual sleeping hours. This implies an abnormal sleeping pattern (whereas "evening work" implies the possibility of sleeping at normal times). As foreseen by directive 2003/88/EC, the definition of usual sleeping hours can vary by country but, in any case, it should include hours between midnight and 5 a.m.

Code 1: "Usually" in this context should be interpreted to mean:

- for self-employed, working during the nights at least half of the days worked in a reference period of four weeks preceding the end of the reference week.
- for employees, having a formal working time arrangement to work in the nights and working during the nights at least half of the days worked in a reference period of four weeks preceding the end of the reference week.

Code 2: "Sometimes" in this context should be interpreted to mean:

- for self-employed, working during the nights less than half of the days worked, but at least in one occasion in a reference period of four weeks preceding the end of the reference week.
- for employees, having a formal working time arrangement to work in the nights and working during the nights less than half of the days worked in a reference period of four weeks preceding the end of the reference week.

Code 3: "Never" in this context should be interpreted to mean:

- for self-employed, working during the nights on no occasion in a reference period of four weeks preceding the end of reference week.
- for employees, having no formal working arrangement to work in the nights.

Col 59: (SATWK) Saturday work

Code 1: "Usually" in this context should be interpreted to mean:

- for self-employed, working on Saturdays at least half of the days worked in a reference period of four weeks preceding the end of the reference week.
- for employees, having a formal working time arrangement to work on Saturdays and working during on Saturdays at least half of the days worked in a reference period of four weeks preceding the end of the reference week.

Code 2: "Sometimes" in this context should be interpreted to mean:

- for self-employed, working on Saturdays less than half of the days worked, but at least in one occasion in a reference period of four weeks preceding the end of the reference week.
- for employees, having a formal working time arrangement to work on Saturdays and working during on Saturdays less than half of the days worked in a reference period of four weeks preceding the end of the reference week.

Code 3: "Never" in this context should be interpreted to mean:

- for self-employed, working on Saturdays on no occasion in a reference period of four weeks preceding the end of reference week.
- for employees, having no formal working arrangement to work on Saturdays.

Col 60: (SUNWK) Sunday work

Code 1: "Usually" in this context should be interpreted to mean:

- for self-employed, working on Sundays at least half of the days worked in a reference period of four weeks preceding the end of the reference week.
- for employees, having a formal working time arrangement to work on Sundays and working during on Sundays at least half of the days worked in a reference period of four weeks preceding the end of the reference week.

Code 2: "Sometimes" in this context should be interpreted to mean:

- for self-employed, working on Sundays less than half of the days worked, but at least in one occasion in a reference period of four weeks preceding the end of the reference week.
- for employees, having a formal working time arrangement to work on Sundays and working during on Sundays less than half of the days worked in a reference period of four weeks preceding the end of the reference week.

Code 3: "Never" in this context should be interpreted to mean:

- for self-employed, working on Sundays on no occasion in a reference period of four weeks preceding the end of reference week.
- for employees, having no formal working arrangement to work on Sundays.

Hours worked

Col 61/62: (HWUSUAL) Number of hours per week usually worked in the main job

Usual hours worked are the modal value of the actual hours worked per week (see definition of Col 63/64) over a long reference period, excluding weeks when an absence from work occurs (e.g. holidays, leaves, strikes ...). For employees covered by an employment contract, it should include contractual hours of work plus overtime that the employee is expected to work regularly according to his or her contract.

The "long reference period" mentioned here is at least the last four weeks and at most the three last months without counting any absence from work. When such a long reference period cannot be identified (because the working hours vary too much, or the person has just started a new job), a proxy can be accepted:

- the contractual hours of work in the reference week, for those who have an employment contract, plus regular overtime if the worker is expected to work overtime
- an average of the actual hours worked in the last four weeks, plus the hours of absence of work in the last four weeks.

The implementation rules mentioned for Col 63/64 about main meal breaks, on-call time, travelling time, training time, working at home, teachers and farmers also apply for HWUSUAL.

People absent for a long period:

For people in employment who last worked before the long reference period of at least four weeks, the usual hours worked should refer to the situation immediately before the start of the extended absence from work. Thus the usual hours of work of persons on maternity leave refer to the usual hours as they would have been identified had the person been asked in the week before starting the maternity leave.

For people who have different working time arrangement depending on seasons, the usual hours worked should refer to the current season.

Col 63/64: (HWACTUAL) Number of hours actually worked during the reference week (main job)

Actual hours worked in the reference week are the hours the person spends in work activities during the reference week.

Work activities should include:

- production activities: activities when directly engaged in the production of good or services as defined in the European System of Accounts.
- ancillary activities: activities not directly intended for the production of goods or services but which are necessary to enable such production (such as travel between places of work, personnel management)
- short pauses: interruptions in the production or ancillary activities that are the necessary consequence of the organisation of the work activities or the use of labour, such as short rest periods (incl. coffee breaks)
- education and training which is necessary for successfully carrying out of either the production or ancillary activities.

Actual hours worked should exclude:

- travel time between home and the place of work
- the main meal breaks
- education and training hours which are not directly necessary for carrying out the production or ancillary activities
- absences from work within the working period for personal reasons (such as visits to the doctor).

Actual hours worked should include time spent at the place of work such as preparing the site, repair and maintenance work, the preparation and cleaning of the tools, and the making-out of receipts, invoices, records of the length of time worked and other reports.

Working hours not paid by the employer (including unpaid overtime)

For employees, the hours have not to be explicitly required by the employer, but it has to be hours spent in activities related to the job that the employee is paid for. The hours spent in such activities but not recognised by the employer should be included in actual hours worked.

On-call time

The directive 2003/88/EC defines on-call time as the “period during which the worker has the obligation to be available at the workplace in order to intervene, at the employer's request, to carry out his activity or duties”⁵.

⁵ Remark: There are two definitions of “on-call” The working time directive essentially refers to what is called “stand-by” in the US. In the 2001 and 2004 ahm on working time arrangements “on-call” was defined differently as a contractual arrangement when the worker only works when called without the obligation either to perform the duty or for the

The workplace is defined as “the place or places where the worker normally carries out his activities or duties and which is determined in accordance with the terms laid down in the relationship or employment contract applicable to the worker”.

The inactive part of on-call time is the “period during which the worker is on-call, but not required by his employer to carry out his activity or duties”.

The active part of on-call time should be obviously included in the working hours.

The idle part at the workplace (e.g. sleeping hours in a hospital for a doctor) should be included in the working hours, as the worker must be in a state of readiness.

The inactivity outside the normal workplace is not work activity unless the burden or the restrictions placed on the worker are too high, such requirement to wear uniforms, to stay in a special accommodations outside the workers home.

Training time inside/outside the workplace

For employees, training time should be included if one of the following statements is true:

- the participation of the employee is required by the employer
- the training takes place inside normal working hours
- the training is directly connected to the current job

Treatment of travelling time for business trips

For purely business trips, related to the current job, travelling time has to be considered as time spent in ancillary activities, and then to be included in actual hours worked.

Working at home

The time spent at home in working activities directly related to the current job has to be taken into account in the actual working hours (and also in the usual, if they occur regularly).

Teachers

Usually the teachers’ employment contract refers to weekly hours spent in the classroom. However, all actual hours worked directly related to teaching have to be considered. It particularly includes teaching in or out the class, preparation and planning the course, marking, attending meetings and conferences related to teaching. Supervision of school trips where attendance is required should be included (sleeping hours during school trips should be excluded).

Farmers

Hours spent in running the farm, preparing the production for selling, supervising employees, as well as hours spent in commercial and administrative tasks linked to the farm should be counted here.

Hours spent in production only designated to own consumption, and hours spent in the farm without doing anything connected to the agricultural business should be excluded.

employer to guarantee the work. In UK English this would be called zero-hours arrangement (example: babysitters).

Col 65/66: (HWOVERP) Paid overtime in the reference week in the main job

Overtime hours are the number of hours actually worked by an employee in excess of his or her contractual hours of work.

Contractual hours of work are the hours the employee is expected to work in the reference week as predetermined (by order of preference) by convention at the enterprise level, by collective agreement or by the legislation.

Paid overtime hours are the number of hours actually worked by an employee in excess of his or her contractual or normal daily or weekly hours of work for which the employee is entitled to compensation, in pay, kind or compensatory leave.

When the person does not know his contractual hours the benchmark should be the general number of hours foreseen by the legislation for full-time workers.

Contractual hours used as benchmark to calculate the overtime hours (contractual or normal hours) should exclude the hours of absence from work during the reference week (free days, leaves, holidays, ...).

Flexitime arrangement is an agreement between the employer and the employee that requires an employee to be at work during a specified core period, but lets them otherwise arrange their hours to suit themselves. During a specific period (a fortnight, a month, a year), the employer and the employee agree on a given number of hours, but the pattern of work can vary from week to week. In this case, only hours outside the flexitime arrangement should be overtime hours. If these working hours are paid as overtime hours, then they should be included here.

Working time banking: extra working hours (hours in addition to contractual hours of work) performed in the reference week, and recuperated later (additional leave or period of rest after the reference week) should be included in overtime hours in the reference week. As there are entitled to compensatory leave, then they should be considered as paid overtime. Daily overtime compensated by time off during the reference week should be excluded here.

For teachers, paid overtime is time spent in paid courses in excess of their regular contract.

Col 67/68: (HWOVERPU) Unpaid overtime in the reference week in the main job

Unpaid overtime hours are the number of hours actually worked by an employee in excess of his or her contractual or normal daily or weekly hours of work for which the employee is not entitled to compensation, in pay, kind or compensatory leave.

For employees, the hours have not to be explicitly required by the employer, but it has to be hours spent in activities related to the job that the employee is paid for. The hours spent in such activities but not recognised by the employer should be included in unpaid overtime.

Flexitime arrangement is an agreement between the employer and the employee that requires an employee to be at work during a specified core period, but lets them otherwise arrange their hours to suit themselves. During a specific period (a fortnight, a month, a year), the employer and the employee agree on a given number of hours, but the pattern of work can vary from week to week. In this case, only hours outside the flexitime arrangement should be overtime hours. If these working hours are not paid as overtime hours, then they should be included here.

Working time banking: extra working hours (hours in addition to contractual hours of work) performed in the reference week, and recuperated later (additional leave or period of rest after the reference week) should be considered as paid overtime and excluded for this variable. Daily overtime compensated by time off during the reference week should also be excluded here.

For teachers, unpaid overtime are hours spent in the preparation of the courses done in addition to their regular contract.

Col 69/70: (HOURREAS) Main reasons for hours actually worked during the reference week being different from the person's usual hours

This question should also be asked of those persons who did not state their usual hours (Col 61/62 = 00). They may know if they have worked considerably more or less than usual even if they cannot give a number for their usual hours.

In a case where more than one reason applies, the reason to be coded is that which explains the greatest number of hours. In the case where the same number of hours is justified by different reasons, the following rule should be applied: if one of these reasons is "overtime" then code 16 should be coded, otherwise the lowest code should be coded.

Code 01: Applies in case of flexitime arrangement.

Code 04: This includes difficulties such as plant breakdown or materials shortage; see also note below on Code 05.

Code 05: This code only applies to persons who were directly involved in a labour dispute. Other persons who did not work because production in the establishment was impeded by a labour dispute (thus causing a shortage in material supplies, for example) are coded 04.

Code 09: Maternity leave is first given to the mother (but may include the leave of the father in the case of a transfer of the entitlements) and corresponds to the compulsory or statutory period of the leave stipulated by national legislation to ensure that mothers before and after childbirth have sufficient rest, or for a period to be specified according to national circumstances. Paternity leave should be included here.

Code 09: Parental leave can be taken either by the mother or the father and is the interruption of work in the case of childbirth or to bring up a child of young age. It should correspond to the statutory period provided by the national legislation. This code is used only for those persons on statutory parental leave (legal or contractual). Any other leave taken for reasons of child-bearing or rearing is coded 10: "special leave for personal or family reasons".

Code 16: Overtime includes paid and unpaid overtime as defined for variables HWOVERP (Col 65/66) and HWOVERPU (Col 67/68).

Col 71: (WISHMORE) Wish to work more hours than the current numbers of hours

Persons in time-related underemployment comprise all persons in employment, as defined in current international guidelines regarding employment statistics, who satisfy the following three criteria during the reference period used to define employment:

- a) "willing to work additional hours", i.e. wanted another job (or jobs) in addition to their current job (or jobs) to increase their total hours of work; to replace any of their current jobs with another job (or jobs) with increased hours of work; to increase the hours of work in any of their current jobs; or a combination of the above. In order to show how "willingness to work additional hours" is expressed in terms of action which is meaningful under national circumstances, those who have actively sought to work additional hours should be distinguished from those who have not. Actively seeking to work additional hours is to be defined according to the criteria used in the definition of job search used for the measurement of the economically active population, also taking into account activities needed to increase the hours of work in the current job;
- b) "available to work additional hours", i.e. are ready, within a specified subsequent period, to work additional hours, given opportunities for additional work. The subsequent period to be specified when determining workers' availability to work additional hours should be chosen in light of national circumstances and comprise the period generally required for workers to leave one job in order to start another;
- c) "worked less than a threshold relating to working time", i.e. persons whose "hours actually worked" in all jobs during the reference period, as defined in current international guidelines regarding working time statistics, were below a threshold, to be chosen according to national circumstances. This threshold may be determined by e.g. the boundary between full-time and part-time employment, median values, averages, or norms for hours of work as specified in relevant legislation, collective agreements, agreements on working time arrangements or labour practices in countries.

The question should refer to the usual situation in all the jobs. In the same resolution as the definition mentioned above, it is stated that: "To provide analytical flexibility for policy formulation and evaluation, as well as for international comparability, countries should endeavour to identify all workers who during the reference period were willing and available to work additional hours, regardless of the hours they actually worked during the reference period".

Col 72: (WAYMORE) Way that a person can work more

Code 4: This code applies to those persons who would like to work a greater number of hours with none of the restrictions set out in codes 1 to 3.

Col 73/74: (HWWISH) Number of hours that the person would like to work in total

This variable should include the total number of working hours the person would like to work.

Col 75: (HOMEWK) Working at home

This concept applies also to self-employed people, for example in artistic or professional activities, who work wholly or partly at home, often in a part of their living accommodation set aside for the purpose.

However, if the place of work comprises a separate unit (for example, a doctor's surgery or tax consultant's practice) which is adjacent to the person's home but contains a separate entrance, then work performed there should not be considered to

be done "at home". Similarly, a farmer is not to be regarded as working "at home" when he is occupied in fields or buildings adjacent to his house.

In the case of employees, "working at home" should be interpreted strictly in terms of formal working arrangements, where it is mutually understood by the employee and the employer that a certain part of the work is to be done at home. Such an arrangement may be explicitly included in the terms of employment, or may be recognised in other ways (for example, if the employee explicitly notifies the employer of this work by completing a timesheet, or by requesting additional payment or other form of compensation). This arrangement is also recognised if an employee is equipped with a computer in his home in order to perform his work.

Other typical examples of "working at home" include travelling salesmen who prepare at home for appointments with clients which are then held at the clients' offices or homes, or persons who do typing or knitting work which on completion is sent to a central location.

"Working at home" does not cover cases where employees carry out tasks at home (because of personal interest or pressure of time), which under their working arrangements might equally have been performed at their place of work.

Code 1: "Usually" in this context should be interpreted to mean that during a reference period of four weeks preceding the interview, the person did work at home within the framework of an agreement as described above, and the number of occasions on which he did so amounted to half or more of the days worked in this period.

Code 2: "Sometimes" in this context should be interpreted to mean that during a reference period of four weeks preceding the interview, the person did work at home within the framework of an agreement as described above, but the number of occasions on which he did so amounted to less than half of the days worked in this period.

Code 3: "Never" in this context should be interpreted to mean that during a reference period of four weeks preceding the interview, the person did not on any occasion work at home within the framework of an agreement as described above.

Col 76: (LOOKOJ) Looking for another job

The reference period of the question should be the four weeks preceding the end of the reference week.

Should be considered as searching for employment (code 1). It includes people who are looking for a different job at the current employer, as well as people who have applied for a permanent position on the same job that they are now performing.

Self-employed people may interpret 'looking for additional job' as trying to increase their present business. Looking for additional clients is not enough to be coded 1 here. Self-employed people should be coded 1 for this question if they were looking for a job as employee or if they were looking for a *different business* in the reference week.

Col 77: (LOOKREAS) Main reason for looking for another job

When more than one reason had been mentioned the order of priority should be 1, 3, 4, 5, 6, 2, and 7, with 1 being the highest priority.

Information about second jobs

Col 78: (EXIST2J) Existence of more than one job or business

The same rules as for main job applies to determine whether the person is employed in his second job or not.

Col 79: (STAPRO2J) Professional status (in the second job)

See notes to Col 27 (Professional Status).

Col 80/81: (NACE2J2D) Economic activity of the local unit (in the second job)

The NACE codes in Annex II are derived from the Statistical Classification of Economic Activities. For the term "local unit" see notes to Col 29/31.

Col 82/83: (HWACTUA2) Number of hours actually worked during the reference week in the second job

See notes to Col 63/64. The number of hours given here corresponds to the number of hours the person actually worked during the reference week in the second job. This includes all hours including extra hours regardless of whether they were paid or not. Travel time between home and the place of work as well as the main meal breaks (normally taken at midday) are excluded.

Persons who have also worked at home (within the definitions given in the notes to Col 75) are asked to include the number of hours they have worked at home. Apprentices, trainees and other persons in vocational training are asked to exclude the time spent in school or other special training centres.

If the number of hours given by the respondent is not a complete number of hours the number should be rounded (ex: 37.5 hours should be coded 38).

Previous work experience of person not in employment

Col 84: (EXISTPR) Existence of previous employment experience

The previous employment experience should be an employment for pay or profit.

A person who only has in his work experience non-paid traineeships should be coded 0 here.

For people on lay-off (WSTATOR= 3), this question refers to the job that they have been laid-off.

In the case of a student who had been continuously performing PAID work alongside with studies, then that experience should be looked upon as a previous work experience, even if the amount of hours was limited.

Col 85/88: (YEARPR) Year in which person last worked

Although compulsory military or community service is not regarded as employment in the framework of the survey, respondents who, after having left their last job, were conscripts on compulsory military or community service should indicate the month and year in which they completed this service in order that this period is not counted in the unemployment duration.

For people on lay-off, this question refers to the job that they have been laid-off. Purely occasional job or vacation work does not include small jobs that are extended over a longer period of time, such as students working few hours every weekend during the school-year.

Col 89/90: (MONTHPR) Month in which person last worked

Although compulsory military or community service is not regarded as employment in the framework of the survey, respondents who, after having left their last job were conscripts on compulsory military or community service should indicate the month and year in which they completed this service in order that this period is not counted in the unemployment duration.

For people on lay-off, this question refers to the job that they have been laid-off.

Col 91/92: (LEAVREAS) Main reason for leaving last job or business

Due to recall problems this variable is restricted to those who had stopped work within the last 8 years, nevertheless if the person has not answered in which year they have last worked, he/she should answer the present question.

Code 00: Dismissed or made redundant

This code is used for employees whose employment ended involuntarily. It includes those employees who were dismissed, made redundant, or lost their job because their employer either went out of business, or sold or closed down the business.

Code 01: A job of limited duration has ended

This code is used for employees who declare that their last job was temporary and came to an end, or that they had a formal work contract which was completed. This also applies to seasonal and casual jobs.

Code 02: Looking after children or incapacitated adults

Care includes all care responsibilities:

- For own children or spouse children living inside or outside the household
- For other children (up to 14) living inside or outside the household
- For adult ill/elderly/incapacitated/disabled relatives/friends (aged 15 or more)

But excludes:

- Care as a job (it means that care done in a professional capacity is excluded).
- Care as a volunteer work (e.g. for a charity organisation)

In both cases, they should be coded as 09.

Code 03: Other personal or family responsibilities

Other personal or family responsibilities may include marriage, pregnancy, long vacation etc. However, if the respondent left his/her job because of personal health-related reasons then code 04 should be used.

Code 06: Early retirement

This code applies to those employees who have taken the early retirement option due to economic factors (labour market problems, difficulties in specific sectors of the economy, etc.), before the normal retirement age in his activity. If the respondent retired from his/her job at the normal retirement age then code 07 should be used.

Code 09: Other reasons

This code is used where none of the codes 00-08 applies, including cases where the person has resigned from his job for reasons (such as personal dissatisfaction) not covered by any of the other codes. Self-employed persons who went out of business, or sold or closed down the business should also be coded 09. People on lay-off should also belong to this category.

Col 93: (STAPROPR) Professional status in last job

See notes for Col 27. Due to recall problems this variable is restricted to those who had stopped work within the last 8 years, nevertheless if the person has not answered in which year they have last worked, he/she should answer the present question.

For people on lay-off, this question refers to the job that they have been laid-off.

Col 94/95: (NACEPR2D) Economic activity of the local unit in which person last worked

See notes for Col 29/31. The NACE codes in Annex II are derived from the Statistical Classification of Economic Activities. For the term "local unit", see notes to Col 29/31.

Due to recall problems this variable is restricted to those who had stopped work within the last 8 years, nevertheless if the person has not answered in which year they have last worked, he/she should answer the present question.

For people on lay-off (Col 24 = 3), this question refers to the job that they have been laid-off.

Col 96/98: (ISCOPR3D) Occupation of last job

See notes for Col 32/35. This should be coded according to the ISCO-COM classification provided in Annex III.

Due to recall problems this variable is restricted to those who had stopped work within the last 8 years, nevertheless if the person has not answered in which year they have last worked, he/she should answer the present question.

For people on lay-off, this question refers to the job that they have been laid-off.

Search for employment

Col 99: (SEEKWORK) Seeking employment during previous four weeks

The period of reference for this variable is the last four weeks ending with the reference week, in order to remain consistent with the variables concerning the methods used during the previous four weeks.

Due to the importance of this question in defining the unemployed, every effort should be made to ensure that an answer is given to this question. 'Blanks' are not allowed.

Those people not seeking employment are questioned on their willingness to work at Col 116.

Persons coded 2 are considered as 'not searching anymore' since they have already found a job. In case they are still searching for a work, they should be coded as 4.

Code 1 and 2: Person has already found a job to start later

This applies to all persons without a job during the reference week, and who have already found a job which will start later. Persons who were coded 1 in this variable

are considered as unemployed when they are available for work in the two weeks after the reference week. Those coded 2 are considered inactive because they were not looking for a job (otherwise they would have been coded 4). The period of 3 months considered follows the week of reference.

Code 4: Person is seeking employment

Also considered as seeking employment is a person who seeks an opportunity of professional training within an enterprise, e.g. as an apprentice or trainee.

Col 100: (SEEKREAS) Reasons for not seeking employment

Code 1: Awaiting recall to work (persons laid-off)

This code is to re-identify those persons who in Col 24 state they are laid-off and not seeking employment.

Code 03: Looking after children or incapacitated adults

Care includes all care responsibilities:

- For own children or spouse children living inside or outside the household
- For other children (up to 14) living inside or outside the household
- For adult ill/elderly/incapacitated/disabled relatives/friends (aged 15 or more)

But excludes:

- Care as a job (it means that care done in a professional capacity is excluded).
- Care as a volunteer work (e.g. for a charity organisation)

In both cases, they should be coded as 8.

Code 7: Belief that no work is available.

This code permits the estimation of the number of "discouraged workers".

Col 101: (SEEKTYPE) Type of employment sought (or found)

Code 1: As self-employed

Persons seeking self-employment, who are without employment during the reference week, are also asked under Col 110-111 whether they have taken any active steps during the past 4 weeks to set up a business, farm or professional practice.

Codes 2/5: Only full-time/part-time job is looked for (or has already been found)

Persons having already found a job as employee which will start later should be coded either 2 or 5 depending on whether the job found is full-time or part-time. Codes 3 and 4 do not apply for this group.

When the person does not know which type of employment he is looking for, it is as to be coded 6 unless he took active steps to be self-employed (code 1 in this case).

Col 102: (SEEKDUR) Duration of search for employment

The period of search should be the last continuous period of active search without significant interruption (in this case significant means at least four weeks).

For people who have found a job which will start later the period of search starts at the beginning of the search and ends when the person finds the job.

Methods used during previous weeks to find work

Col 103 to 115: (METHOD(A-M))

The 11th principle for the formulation of the question of the labour status (Commission Regulation 1897/2000) states that: "Questions are enumerated until at least three active methods have been mentioned".

Blanks are not allowed. If a person does not know or refuses to answer this should be coded as 0.

Only the methods used during the four weeks ending with the reference week are to be recorded

Col 103: (METHODA) Contacted public employment office to find work

"The 'contact with the public employment office to find work' only involves:

- putting the respondent's names in the employment office files for the first time (after a spell of employment or inactivity)
- finding out about possible job vacancies, or
- 'at the initiative of the employment office a suggestion of a job opportunity', which may be accepted or refused by the job searcher."

Contacts through the website of the public employment office with the objective of finding a job should be coded 1 (yes).

Col 107: (METHODD) Inserted or answered advertisements in newspapers or journals

The insertion or the answer of advertisements from a website (excepted website of public employment service) should be coded 1 here.

Col 108: (METHODF) Studied advertisements in newspapers or journals

The consultation of job advertisements in internet and the consultation of list of job vacancies in the entrance of the factories should be coded as 1 (yes).

Col 115: (METHODM) Other method used

In this Column, the answer "yes" should be recorded only if the person has used an active method not covered by Col 103 to 111. Passive methods not coded before should be coded no.

Use of Internet should not be considered as a separate method, but as a mode of the relevant methods in Col 103 to 111. Browsing the internet to look for available job openings is thus a mode of reading advertisements in journals and newspapers.

Sending an inquiry through a web-side form or e-mail to a public employment office in order to find a job is thus contact with a public employment office for the purpose of finding a job, etc.

Col 116: (WANTWORK) Willingness to work for person not seeking employment

This question is intended to permit a more exact measure for "discouraged workers". It is put to persons coded 3 Col 99, i.e. without employment and not seeking employment. Discouraged workers are persons who are not seeking work because they believe that none is available (Col 100=7) but would nevertheless like to have a job (Col 116=1).

The reference period of this question is the reference week, but it is not necessary to mention it in the questionnaire. The person is asked whether he/she would like to have a paid employment, whatever the number of hours worked.

Col 117: (AVAILBLE) Availability to start working within two weeks

'Immediately available' means that if a job were found at the time of the interview, the person would be able to start work within two weeks.

Testing for availability in the two weeks following the reference week is considered more appropriate than testing during the reference week, because some persons may be unavailable for work during the reference week due to obstacles that might have been overcome had they known that a job was available to them.

Col 118: (AVAIRESAS) Main reason for not being available to start working within two weeks

The variable is used to set the position of inactive people with respect to the labour market. Ask spontaneous reasons. Main reason should be collected.

Col 119: (PRESEEK) Situation immediately before person started to seek employment

If more than one category applies, the main situation should be coded.

If the person did not search employment because the job was offered, the situation to be coded is the one when the job was offered.

Col 120: (NEEDCARE) Need for care facilities

Care includes all care responsibilities:

- for own children or spouse children living inside or outside the household
- for other children (up to 14) living inside or outside the household
- for adult ill/elderly/incapacitated/disabled relatives/friends (aged 15 or more)

But excludes:

- Care as a job (it means that care done in a professional capacity is excluded).
- Care as a volunteer work (e.g. for a charity organisation)

The need for care services can be a need for normal working hours or for special periods of day (very early in the morning or late evening) or for special periods of the year (e.g. school holidays).

Care services exclude the unpaid help by relatives, friends or neighbours. The care services can be private or subsidised by the State or the employers and consequently paid or not paid.

Some examples of care services could be crèche, day care centre, organised family care (e.g. family crèches, home-based care by childminders affiliated to a child minding service), after school centre, paid carers, specialised centres for persons with disabilities, institutions, assistance at home.

The word "suitable" means the minimum standards of quality that the person requests from a care service. This notion of quality involves schedules, quality of the personnel, specific expertise to care for the particular care needs (e.g. disability) in question, etc.

The word “available” means at a reasonable distance, taking into account also the means of transport and currently open/available for use to the respondent.

The word “affordable” should take into account the relation/balance between:

- an eventual future salary for the person who would work or work more if care services were available
- and the cost of the care service.

Col 121: (REGISTER) Registration at public employment office

Only people who are registered at a public employment office as job-seekers should be coded 1 or 2.

For persons having declared themselves to be seeking employment this question should be the last in the section on seeking employment, as it is important not to give the subject of registration too much emphasis in defining the unemployed.

Since unemployment will basically be defined by the criteria of job search and availability for work the respondents' answer to these questions should not be conditioned by whether or not they are registered at an official employment exchange.

Persons who are in employment and who register in a public employment office to find another job should be coded 2 or 1 (for those who receive complementary unemployment benefits).

Benefits, in this context should be limited to allowances linked with unemployment status (not other social benefits).

The reference period of this question should be end of the reference week.

Main status

Col 122: (MAINSTAT) Main status

The “main activity status” gives each person’s self-perception regarding his/her activity status; for instance, students with small jobs will in general present themselves as students. The reference period for this variable is the reference week.

This question shouldn’t in any case precede the questions on the labour status according to the ILO definition or the questions on the registration at the public employment office.

Code 8 should also be used to classify persons who cannot say they are “carrying out a job or profession” nor fit into other groups but on an extended leave from such a job.

Education and training

Col 123: (EDUCSTAT) Student or apprentice in regular education during the last four weeks

Regular (formal education) is defined as education and training with the following characteristics:

- purpose and format are predetermined
- provided in the system of schools, colleges, universities and other educational institutions
- it normally constitutes a continuous ladder of education.

- it is structured in terms of learning objectives, learning time and learning support
- it is normally intended to lead to a certification recognised by national authorities (qualifying for a specific education/programme).
- corresponds to the programmes covered by the UOE-questionnaires.

The list of national programmes covered by the UOE-questionnaire is found at the address:

http://forum.europa.eu.int/Public/irc/dsis/edtes/library?l=/public/unesco_Collection/programmes_isced97&vm=detailed&sb=Title

Apprentice: student in regular education but completing his/her studies by apprenticeship foreseen in the educational programme (even if paid).

This variable only covers the regular education system (formal education, including schools, Colleges and universities) and which the respondent has attended sometime during the last 4 weeks period ending with the reference week.

If the interviewee is enrolled as a student or an apprentice in a programme within the regular education system the answer is code 1. This includes modules (short programmes/courses) which may be part of a longer regular education programme and are taken and completed, giving to their graduates the corresponding academic credit, independent of whether the person continues to complete the full programme or not. The field and level of the short programmes/courses will be the same as the programme of which they form part.

For apprentices who in the past 4 weeks are in a period of only 'on-the-job training' or alternate 'on-the-job' and 'in-school learning' within the framework of an alternate (e.g. dual) programme, the answer is code 1, since the person is enrolled in a qualifying programme.

Code 3 (person in regular education but on holidays) applies for students enrolled but on school holidays and for those who will continue their studies after holidays.

The purpose of this code is to eliminate to minimum in the summer interviews doubts about being in regular education (codes 1 and 3 to be considered together). It is very difficult to give precise rules for each case but it could be recommended to take into account the situation of the person in the previous educational period (in spring), what corresponds probably to a natural answer from respondents. The subjective perception of this situation has to be respected in the case if the respondent does not know yet about his/her situation after holidays (exams to be passed in the second session, not yet reply received from the educational institution concerning the new studies, etc).

Col 124: (EDUCLEVL) Level of the current education or training

Level refers to the programme mentioned in Col 123.

Level is coded according to the International Standard Classification of Education 1997 and consists of only levels without destination (educational or labour market: A-C) or orientation (general, pre-vocational, vocational).

- ISCED 1 Primary education
- ISCED 2 Lower secondary education
- ISCED 3 Upper secondary education
- ISCED 4 Post secondary education, non-tertiary
- ISCED 5 Tertiary education

- ISCED 6 Postgraduate education

Level 4 may not exist in some countries. Please check your ISCED-mapping.

For the persons coded 3 in Col 123 (*Student or apprentice in regular education during the last four weeks*), the educational level of the education or training attended before their holidays.

If the respondent has been enrolled in several educational programmes during the reference period he/she should only give information on the highest level of educational programme.

Col 125/127: (EDUCFILD) Field of the current education or training

If the respondent has been enrolled in several educational programmes during the reference period he/she should only give information on the field in the highest level of educational programme.

Col 128: (COURATT) Did you attend any courses, seminars, conferences or receive private lessons or instructions outside the regular education system (hereafter mentioned as taught learning activities, job-related or for personal purposes) within the last four weeks

This variable covers all taught organised learning activities outside the regular education system and which the respondent has attended during the last four weeks ending with the reference week. This is what may be called non-formal education and training.

A non-formal learning activity is defined as being organised like a course, a conference or seminar for which the interviewee has applied and has participated in. It could be for a short or a longer period also with minor breaks.

A non-formal learning activity may exceed the reference period (starting before or finishing later). It includes the following activities:

- Attending a course or a seminar to acquire or to improve skills, knowledge and competence. This includes both courses leading to certificates and courses not leading to certificates. The courses can be attended to improve job related knowledge or improve skills for social and personal purposes.
- Attending a seminar, a course or a lecture to gain vocational guidance and to give a first step to working life (but outside formal education). This includes measures which show and analyse the labour market, his or hers needs and possibilities and which help to choose a job and also measures which improve basic skills/key skills in public or private institutions. The training is taught and within a group on full time basis (or maybe part time) for a shorter period.
- Doing a correspondence course, a tele-teaching or a comparable measure of teacher-supported distance learning to improve skills, knowledge or competence.
- Taking private lessons to improve skills, knowledge and competence, especially as a supplement to formal education. This includes supplementary course by a private tutor. Leisure classes for example studying a language for 'leisure' purposes, even if the qualifications achieved may correspond to (part of) A-level, the attendance should be considered as a non-formal 'course'.

Col 129/131: (COURLEN) Number of hours spent on all taught learning activities within the last four weeks

Duration in number should reflect the number of taught hours only. The definition of total time spent in taught learning by the individual is the total number of hours that the individual has spent on participating in classes, seminars, conferences, lectures, tutorials etc. or receiving instruction or advice. Only the hours of instruction should be included in the total time spent in taught learning, which means that travelling time and homework should be excluded.

Col 132: (COURPURP) Purpose of the most recent taught learning activity

Job-related (professional): the respondent takes part in this activity in order to obtain knowledge and/or learn new skills for a current or a future job, increase earnings, improve job- and/or carrier opportunities in a current or another field and generally improve his/her opportunities for advancement and promotion.

Non job-related (personal/social): the respondent takes part in this activity in order to develop competencies required for personal, community, domestic, social or recreational purposes.

Col 133/135: (COURFILD) Field of the most recent taught learning activity

Although the classification used does not cover the very broad offer of subjects in courses, conferences, seminars etc, it is coded in the same way as programmes under HATFIELD (Col 139/141) and EDUCFILD (Col 125/127) to facilitate implementation and allow aggregation.

Col 136: (COURWORH) Did the most recent taught learning activity take place during paid working hours?

This variable informs on the support to the course by the employer. It refers to the degree that the activity takes place during paid working hours meaning that the working hours are used to attend the activity instead of working. It also includes the case of where a number of working hours are being replaced by learning activity even if the activity itself takes place outside normal working time of the respondent.

If the learning activity takes place outside normal working time and the respondent has received payment for the hours or additional leisure hours, the activity should be coded as during paid working hours.

The answer should only reflect the participation in the course itself and not homework.

For self-employed normal working time instead of paid hours should be taken into account.

Contributing family workers (those workers who hold a 'self-employment' job in a market-oriented establishment operated by a related person living in the same household), who cannot be regarded as partners, voluntary social workers and others working without being paid but attending a course within that area should be coded as "4: Only outside paid hours", as there are no paid working hours.

If a person attends a long course (within the reference period) and does not have a job all the time of the course, there will be two periods of the course: the period where the person is in job and the period where the person is not in job. The answer and coding

should reflect the situation in the longest period of the course (again within the reference period).

Col 137/138: (HATLEVEL) Highest level of education or training successfully completed
Level is coded according to the International Standard Classification of Education (ISCED 97).

Persons with no education (illiterate) should be coded 00.

The expression "level successfully completed" must be associated with obtaining a certificate or a diploma, when there is a certification. In cases where there is no certification, successful completion must be associated with full attendance.

When determining the highest level, both general and vocational education/training should be taken into consideration.

Persons who have not completed their studies should be coded according to the highest level they have completed and should not be coded with a blank.

Code 30 should only be used in those cases in which a distinction a, b, c of ISCED 3 is not possible.

Col 139/141: (HATFIELD) Field of highest level of education or training successfully completed

Field is coded according to the "Manual on fields of education and training", EUROSTAT 1999.

ISCED 97 contains 25 two-digit fields of education. The classification used here goes up to a three-digit code in a hierarchical system for classifying fields of education, where the two-digit level is the ISCED 97 fields of education. It is mainly the first two digits that are used in international data collection. However, the third digit gives a more flexible system, and other aggregations based on the third digit may be used in ad hoc data collections to suit specific purposes.

The rule for coding is that the respondents should be coded with the most detailed code possible and only with one code.

Col 142/145: (HATYEAR) Year when highest level of education or training was successfully completed

The expression "level successfully completed" must be associated with obtaining a certificate or a diploma, when there is a certification. In cases where there is no certification, successful completion must be associated with full attendance.

Situation one year before survey

The information collected through the following questions in this section, are used to assess mobility of various types: between employment, unemployment and inactivity; of professional status; of economic activity; geographical mobility. Clearly such mobility measures, based upon the respondent's situation at two points in time, can only indicate at most one change in each case (for example, from unemployed to

employed), whereas in fact several changes may have taken place over this period (for example, unemployed - employed - inactive - employed). Also, the International Labour Organisation definitions used elsewhere in the survey cannot be applied here, since not all the questions necessary can be asked (for example, availability for work, job search, etc.). The variables “current main status” and “main status one year before the survey” have exactly the same structure in order to permit these comparisons.

Col 146: (WSTAT1Y) Situation with regard to activity one year before survey

The reference period of this question is the week one year before the reference week.

Code 6: Person was conscripted on compulsory military or community service

Although conscripts on compulsory military or community service are excluded from the survey results, this code identifies persons who were conscripts a year before the survey. This is important in identifying labour force entrants.

Col 147: (STAPRO1Y) Professional status one year before survey

For the codification, see variable STAPRO (Col 27)

Col 148/149: (NACE1Y2D) Economic activity of local unit in which person was working one year before survey

See variable NACE3D (Col 29/31). The NACE codes in Annex II are derived from the Statistical Classification of Economic Activities.

Col 150/151: (COUNTRY1Y) Country of residence one year before survey

For coding, see ISO country classification (see Annex IV). This refers to the usual residence one year before.

Col 152/153: (REGION1Y) Region of residence one year before survey

This is based on NUTS 2 (see Annex 1). This refers to the usual residence one year before.

Income

Col 154/155: (INCDECIL) Monthly (take-home) pay from main job

The monthly (take-home) pay is the pay after (provisional, subject to revision later) deduction of income tax and National Insurance Contributions. It includes regular overtime, extra compensation for shift work, seniority bonuses, regular travel allowances and per diem allowances, tips and commission, compensation for meals. Income from investments – assets, savings, stocks and shares... should not be included in monthly wages and salaries.

Holiday bonuses (13th and/or 14th month) and fringe benefits should be considered dividing their amount by 12.

If the job is an occasional job for a short period, the amount should be an estimate of the total earnings from all similar jobs in that month.

The deciles should be calculated and provided once data for the whole year are collected, checked, and corrected from the non-response.

The first decile (code 01) should refer to people with lowest wages, the 10th (code 10) should refer to people with highest wages.

Technical items relating to the interview

Col 156/159: (REFYEAR) Year of survey

This variable refers to the year in which the Thursday of the reference week belongs.

Col 160/161: (REFWEEK) Reference week

The reference weeks should follow the Norm ISO 8601 which indicates that, according to the Gregorian calendar, the first week of the year is the one that includes the first Thursday of that year.

Concretely:

- Week 1 of 2008 starts the 31st December 2007
- Week 1 of 2009 starts the 29th December 2008
- Week 1 of 2010 starts the 4th January 2010
- Week 1 of 2011 starts the 3rd January 2011

As the year has 365 days (except leap years which have 366 days) and the quarterly survey covers 364 days ($52 \times 7 = 364$), every year the Thursday of the first week of the first quarter moves (backward) to the previous day of the month. After some years that Thursday will be the 31st of December of year Y-1. In this case the sample should be spread over 14 weeks.

Col 162/163: (INTWEEK) Interview week

This information used with reference week gives an indication of the recall period and information on the quality of the answer.

Col 164/165: (COUNTRY) Country

This should be provided according to the coding in Annex IV.

Col 166/167: (REGION) Region of household

This should be provided to the coding system in Annex I, which is based on the Classification of Territorial Units (NUTS). The third and fourth digits of the NUTS code (that is, the level II regional code) should be provided.

Col 168: (DEGURBA) Degree of urbanisation

The concept of "urbanisation" has been introduced to indicate the character of the area where the respondent lives. Three types of area have been identified, as follows:

- densely-populated (Code 1)
- intermediate (Code 2)
- thinly-populated (Code 3)

In the definition of "Degree of urbanisation" there is a criterion of geographical contiguity together with a population threshold. Harmonised, comparable correspondence between the Degree of Urbanisation and NUTS 5 regions has been (re-)defined on the basis of 2001 census data (for Member States and Candidate countries) in 2005.

An "area" consists of a group of contiguous "local areas" where a "local area" corresponds to the following entities in the respective countries:

Labour Force Survey - United Kingdom

Belgium	Gemeenten/Communes	
Czech Republic	Obce	6,249
Denmark	Kommuner	271
Germany	Gemeinden	13,176
Estonia	Vald, Inn	241
Greece	Demotiko diamerisma/Koinotiko diamerisma	6,130
Spain	Municipios	8,108
France	Communes	36,678
Ireland	DEDs/Wards	3,440
Italy	Comuni	8,100
Cyprus	Dimoi, koinotites	614
Latvia	Pilsētas, novadi, pagasti	530
Lithuania	Seniūnijos	515
Luxembourg	Communes	118
Hungary	Települések	3,145
Malta	Kunsilli	68
The Netherlands	Gemeenten	489
Austria	Gemeinden	2,381
Poland	Gminy	2,478
Portugal	Freguesias	4,257
Slovenia	Občine	193
Slovakia	Obce	2,928
Finland	Kunnat /Kommuner	446
Sweden	Kommuner	290
United Kingdom	Wards (or parts thereof)	10,679
Bulgaria	Naseleni Mesta	5,340
Croatia		
Romania	Communes+ Municipiu +Orajse	2,951
Turkey	Köy	37,675
Iceland	Sveitarfélag	101
Norway	Kommuner	433
Switzerland	Gemeinden / Communes / Comuni	2,815

The three types of area described above are defined as follows:

Code 1: Densely-populated area

This is a contiguous set of local areas, each of which has a density superior to 500 inhabitants per square kilometre, where the total population for the set is at least 50,000 inhabitants.

Code 2: Intermediate area

This is a contiguous set of local areas, not belonging to a densely-populated area, each of which has a density superior to 100 inhabitants per square kilometre, and either with a total population for the set of at least 50,000 inhabitants or adjacent to a densely-populated area.

Code 3: Thinly-populated area

This is a contiguous set of local areas belonging neither to a densely-populated nor to an intermediate area.

A set of local areas totalling less than 100 square kilometres, not reaching the required density, but entirely enclosed within a densely-populated or intermediate area, is to be considered to form part of that area. If it is enclosed within a densely-populated area and an intermediate area it is considered to form part of the intermediate area.

Col 169/174: (HHNUM) Serial number of the household

Serial numbers are allocated by the national statistical institutes and remain the same for all waves. Records relating to different members of the same household carry the same serial number.

Col 175: (HHTYPE) Type of household

A private household (housekeeping unit concept) is either:

- a) a one-person household, i.e. a person who lives alone in a separate housing unit or who occupies, as a lodger, a separate room (or rooms) of a housing unit but does not join with any of the other occupants of the housing unit to form part of a multi-person household as defined below, or
- b) a multi-person household, i.e. a group of two or more persons who combine to occupy the whole or part of a housing unit and to provide themselves with food and possibly other essentials for living. Members of the group may pool their incomes to a greater or lesser extent.

The household-dwelling concept (the aggregate number of persons occupying a housing unit) can equally be accepted.

These definitions comprise all persons living in the households surveyed during the reference week, and those persons absent from the household for short periods due to studies, holidays, illness, business trips, etc. In this context short period means less than one year in total (time already elapsed plus the time remaining until the foreseen return).

An institutional household comprises persons whose need for shelter and subsistence are being provided by an institution.

Col 176: (HHINST) Type of institution

This gives information on the distribution of the population by type of collective household.

Col 177/182: (COEFFY) Yearly weighting factor

Each person in the survey sample may be considered to be "representative" of a certain number of other persons not in the sample. The record for each responding individual is therefore assigned a weighting indicating how many persons are in this sense "represented" by this individual.

In order to have consistency between individual and household statistics the same weighting factor should be allocated to all the members of the household.

The '4 first digits' should correspond to whole numbers and the '2 last digits' should correspond to decimal places (without any coma before).

Col 183/188: (COEFFQ) Quarterly weighting factor

In order to have a measure of each variable at quarterly level a quarterly weighting factor should also be calculated. See also notes for Col 183/188 (*Yearly weighting factor*).

Countries still having a yearly survey are requested to fill these columns with the Yearly weighting factor.

Col 189/194: (COEFFH) Yearly weighting factor of the sample for household characteristics (in the case of a sample of individuals)

According to Article 2, § 4. of the regulation for a continuous labour force survey, if the sampling unit is the individual, information can be collected for a sub-sample defined in such way that:

- The reference weeks are uniformly distributed throughout the whole year;
- The number of observations (individuals sampled plus the members of their household) satisfies, for the annual estimates of levels, the reliability criteria.

For countries providing household data using this kind of sub-sample (and only for these countries) this weighting factor should be calculated for each person composing the sub-sample.

Col 195: (INTWAVE) Sequence number of the survey wave

The sequence number of the wave should correspond to the number of times that the individual/household is in the sample. The quarters where the individual/household is not in the sample should be excluded from the counting.

For countries where the sample unit is the household, the sequence number of the survey wave is attached to the household. Therefore it should follow the same pattern for all individuals of the same household. For instance a new person joining the household (and the sample) in wave 2 would be assigned number 2. A person present in wave 1, absent in wave 2 but present in wave 3 would be assigned number 3 when interviewed in wave 3.

Col 196: (INTQUEST) Questionnaire used

Code 1 applies for interviews that do not use the whole questionnaire (yearly + quarterly variables).

Levels of Education and Training

ISCED 0 - Pre-primary Education

Programs at level 0, (pre-primary) defined as the initial stage of organised instruction is designed primarily to introduce very young children to a school-type environment, i.e. to provide a bridge between the home and a school based atmosphere. Upon completion of these programs, children continue their education at level I (primary education).

ISCED I - Primary Education or First Stage of Basic Education

Programmes at level I are normally designed on a unit or project basis to give students a sound basic education in reading, writing and mathematics along with an elementary understanding of other subjects such as history, geography, natural science, social science, art and music. In some cases religious instruction is featured. The core at this level consists of education provided for children, the customary or legal age of entrance being not younger than five years or older than seven years. This level covers, in principle, six years of full-time schooling.

ISCED 2 - Lower Secondary Education or Second Stage of Basic Education

The contents of education at this stage are typically designed to complete the provision of basic education which began at ISCED level 1. In many, if not most countries, the educational aim is to lay the foundation for lifelong learning and human development. The programmes at this level are usually on a more subject oriented pattern using more specialised teachers and more often several teachers conduct classes in their field of specialisation. The full implementation of basic skills occurs at this level. The end of this level often coincides with the end of compulsory schooling where it exists.

ISCED 3 - (Upper) Secondary Education

This level of education typically begins at the end of full-time compulsory education for those countries that have a system of compulsory education. More specialisation may be observed at this level than at ISCED level 2 and often teachers need to be more qualified or specialised than for ISCED level 2. The entrance age to this level is typically 15 to 16 years. The educational programmes included at this level typically require the completion of some 9 years of full-time education (since the beginning of level 1) for admission or a combination of education and vocational or technical experience.

ISCED 3A: Programmes designed to provide direct access to ISCED 5A;

ISCED 3B: Programmes designed to provide direct access to ISCED 5B;

ISCED 3C: Programmes not designed to lead to ISCED 5A or 5B.

ISCED 4 - Post-Secondary Non Tertiary Education

ISCED 4 captures programmes that straddle the boundary between upper secondary and post-secondary education from an international point of view, even though they might clearly be considered as upper secondary or post-secondary programmes in a national context. These programmes can, considering their content, not be regarded as tertiary programmes. They are often not significantly more advanced than programmes at ISCED 3 but they serve to broaden the knowledge of participants who have already completed a programme at level 3.

Typical examples are programmes designed to prepare students for studies at level 5 who, although having completed ISCED level 3, did not follow a curriculum which would allow entry to level 5, i.e. pre-degree foundation courses or short vocational programmes. Second cycle programmes can be included as well.

ISCED 4A: See text for ISCED 3

ISCED 4B: See text for ISCED 3

ISCED 4C: See text for ISCED 3

LEVEL 5 - First Stage of Tertiary Education (not leading directly to an advanced research qualification)

This level consists of tertiary programmes having an educational content more advanced than those offered at levels 3 and 4. Entry to these programmes normally requires the successful completion of ISCED level 3A or 3B or a similar qualification at ISCED level 4A. They do not lead to the award of an advanced research qualification (ISCED 6). These programmes must have a cumulative duration of at least two years.

ISCED 5A: Programmes that are largely theoretically based and are intended to provide sufficient qualifications for gaining entry into advanced research programmes and professions with high skills requirements.

ISCED 5B: Programmes that are practically oriented/ occupationally specific and are mainly designed for participants to acquire the practical skills and know-how needed for employment in a particular occupation or trade or class of occupations or trades, the successful completion of which usually provides the participants with a labour-market relevant qualification

ISCED 6 - Second Stage of Tertiary education (leading to an advanced research qualification)

This level is reserved for tertiary programmes which lead to the award of an advanced research qualification. The programmes are therefore devoted to advanced study and original research and not based on course-work only.

They typically require the submission of a thesis or dissertation of publishable quality which is the product of original research and represents a significant contribution to knowledge. They prepare graduates for faculty posts in institutions offering ISCED 5A programmes, as well as research posts in government, industry, etc.

Programme Orientation

General Education

Education which is mainly designed to lead participants to a deeper understanding of a subject or group of subjects, especially, but not necessarily, with a view to preparing participants to higher (additional) education at the same or a higher level. Successful completion of these programmes may or may not provide the participants with a labour-market relevant qualification. These programmes are typically school-based. Programmes with a general orientation and not focusing on a particular specialisation should be classified in this category.

Pre-vocational and Pre-technical education

Education which is mainly designed to introduce participants to the world of work and to prepare them for entry into vocational and technical education programmes. Successful completion of such programmes does not yet lead to a labour-market relevant vocational or technical qualification. For a programme to be considered as pre-vocational or pre-technical education, at least 25% of its content has to be vocational or technical. This minimum is necessary to ensure that the vocational subject or the technical subject is not only one among many others.

Vocational and technical education

Education which is mainly designed to lead participants to acquire the practical skills, know-how and understanding necessary for employment in a particular occupation or trade or class of occupations or trades. Successful completion of such programmes leads to a labour-market relevant vocational qualification recognised by the competent authorities in the country in which it is obtained (e.g. Ministry of Education, employers' associations, etc.).

SECTION 8: EUROSTAT AD HOC MODULES

Under Regulation (EC) No 577/98, EuroStat includes a number of variables each year which provide information on aspects of the labour market that do not form part of the standard questionnaire. This set of variables, constitute an "ad hoc module".

Regulations adopting the programme of ad hoc modules	Regulations adopting the specifications	Ad hoc module description	Year
<u>Commission Regulation (EC) No 365/2008</u> of 23 April 2008 adopting the programme of ad hoc modules covering the years 2010 to 2012	*	Transition from work into retirement	2012
	*	Employment of disabled people	2011
	<u>Commission Regulation (EC) No 20/2009</u>	Reconciliation between work and family life	2010
<u>Commission Regulation (EC) No 384/2005</u> of 7 March 2005 adopting the programme of ad hoc modules, covering the years 2007 to 2009	<u>Commission Regulation (EC) No 207/2008</u>	Transition from school to work life	2009
	<u>Commission Regulation (EC) No 102/2007</u>	Labour Market situation of migrants and the immediate descendants of migrants	2008
	<u>Commission Regulation (EC) No 391/2008</u> (amendment concerning BG and RO)		
	<u>Commission Regulation (EC) No 341/2006</u>	Accidents at work and work-related health problems	2007
<u>Commission Regulation (EC) No 246/2003</u> of 10 February 2003 adopting the programme of ad hoc modules, covering the years 2004 to 2006	<u>Commission Regulation (EC) No 388/2005</u>	Transition from work into retirement	2006
	<u>Commission Regulation (EC) No 29/2004</u>	Reconciliation between work and family life	2005
	<u>Commission Regulation (EC) No 247/2003</u>	Work organisation and working time arrangements	2004
<u>Commission Regulation (EC) No 1626/2000</u> of 24 July 2000 adopting the programme of ad hoc modules, covering the years 2001 to 2004	<u>Commission Regulation (EC) No 1313/2002</u>	Lifelong learning	2003
	<u>Commission Regulation (EC) No 1566/2001</u>	Employment of disabled people	2002
	<u>Commission Regulation (EC) No 1578/2000</u>	Length and patterns of working time	2001
<u>Commission Regulation (EC) No 1924/1999</u> of 8 September 1999 adopting the programme of ad hoc modules, covering the years 2000 to 2002	<u>Commission Regulation (EC) No 1925/1999</u>	Transition from school to working life	2000
	<u>Commission Regulation (EC) No 1571/98</u>	Accidents at work and occupational diseases	1999

* Under discussion

For more information on Eurostat ad hoc modules: -
http://circa.europa.eu/irc/dsis/employment/info/data/eu_lfs/LFS_MAIN/LFS/lfs_regulations.htm

Specifications of the 2009 ad hoc module on the entry of young people into the labour market

Column	Code	Description	Filter
203 (PARHAT)	1 2 3 9 Blank	Highest level of education successfully completed by father or mother Low: ISCED 0, 1, 2 and 3c short Medium: ISCED 3-4 (without 3c short) High: ISCED 5-6 Not applicable (persons aged less than 15 or more than 34) No answer	Everybody aged 15-34
204-207 PARFOR 9999 Blank	Country of birth of father and mother <i>(For Germany: nationality/former nationality of father and mother when they have in the reference week the German nationality)</i> For coding, see ISO country classification 4 digits (father - 2 first digits, mother - 2 last digits) Not applicable No answer	Everybody aged 15-34
208 HATVOC	1 2 3 4 5 9 Blank	Orientation of the highest level of formal education attained (HATLEVEL) General education Vocational education mainly (or solely) school based Combination of school and work place based vocational education Vocational education mainly work place based Vocational education, with no distinction possible between 2, 3 and 4 Not applicable No answer	Everybody aged 15-34 and HATLEVEL=21-43
209-214 STOPDATE	... 999999 Blank	Month and year of leaving formal education for the last time Month and year Not applicable No answer	Everybody aged 15-34 and EDUCSTAT=2 and HATLEVEL≠00
215 WORKEDUC	0 1 2 3 4 5 6 7 9 Blank	Work during studies in formal education No work or work less than 1 month per year Work (only) as part of educational programme Work while studying but outside educational programmes Work (only) during an interruption of studies Work as combination of 1 and 2 Work as combination of 1 and 3 Work as combination of 2 and 3 Work as combination of 1, 2 and 3 Not applicable No answer	Everybody aged 15-34
216-221 JOBSTART	000000 000001 999999 Blank	Month and year of start of the first job of more than 3 months after leaving formal education for the last time Never had a job of more than 3 months Current job is my first job Month and year Not applicable No answer	Col.209-214 ≠ 999999 and blank
222-224 JOB DUR	... 999 Blank	Duration of the first job of more than 3 months (after leaving formal education for the last time) Number of months Not applicable No answer	Col. 216-221 ≠ 000000 and 000001 and 999999
225 FINDMETH	1 2 3	Method which allowed to find the first job of more than 3 months (after leaving formal education for the last time) Via educational institution Via PES (Public Employment Services) Via ads in press or on the Internet	Col. 216-221 ≠ 000000 and 999999

Labour Force Survey - United Kingdom

Column	Code	Description	Filter
	4 5 6 7 8 9 Blank	Submission of direct (spontaneous) job application to employer Via family and friends Job found after previous experience (summer/student job, apprenticeship, traineeship, voluntary job) in the same company Launching private business Other Not applicable No answer	
226-229 JOB OCC 9999 Blank	Occupation of the first job of more than 3 months (after leaving formal education for the last time) ISCO-88 (COM) coded at 3 or if possible 4 digits level Not applicable No answer	Col. 216-221 ≠ 000000 and 000001 and 999999
230 JOB CONTR	1 2 3 4 5 6 9 Blank	Type of contract of the first job of more than 3 months (after leaving formal education for the last time) Self-employed Employee, permanent full-time Employee, permanent part-time Employee, temporary full-time Employee, temporary part-time Family worker Not applicable No answer	Col. 216-221 ≠ 000000 and 000001 and 999999
231 TRANSACT	1 2 3 4 5 6 7 8 9 Blank	Main activity after leaving formal education for the last time and before starting the first job of a duration of at least 3 months Employed - work in job(s) of short duration (maximum 3 months) Compulsory military or community service Not employed, actively looking for the job Not employed, not looking actively for a job because of: Family responsibilities Participation in non-formal education Voluntary activities Health problems Other reasons Not applicable No answer	Col. 209-214 ≠ 999999 and blank and {first job started more than 3 months after the date in Col. 209-214 or Col. 216-221 = 000000}
232/237	0000-9999 00-99	Weighting factor for the LFS module 2009 (optional) Columns 232-235 contain whole numbers Columns 236-237 contain decimal places	Everybody aged 15-34
238 (PARFOR)	9999 Blank	Nationality at birth of parents (optional) For coding, see ISO country classification Not applicable No answer	Everybody aged 15-34

Explanatory Notes for LFS 2009 ad hoc module

Col 203: Highest level of education successfully completed by father or mother

This variable will need two questions (about father and mother separately).

Parents:

- If the father and the mother belong to the household, the information on their highest level of education can be taken from the core LFS without asking the question.
- Response to this question should be spontaneous.

Labour Force Survey - United Kingdom

If interviewee asks about which parents (biological or not) should be considered, the interviewer should ask him firstly on those with whom the person grew up (e.g. step mother/father rather than biological one not living in the same household). This question can also concern other persons with whom the interviewee spent most childhood (e.g. grandparents).

In the case of doubts, parents could be defined as those living with the person around the age of 15 (the information on the educational level of parents should however correspond to the highest level achieved and not to the level achieved at the time the child was 15 years old). If the interviewee grew up with a single person, his/her educational level should be considered as "highest". People brought up in institutions should be coded blank.

- The level of education is coded according to the International Standard Classification of Education (ISCED 97). The NEACs (National Educational Attainment Classification) or other national classifications provide information about educational attainment according to the specific national situation. They constitute the basis for the recoding of national levels into the ISCED.
- At the European level, data on educational attainment of parents will only be coded according to three broad categories (low - medium - high). However, in the national questionnaires countries should collect the information at a sufficient level of detail in educational attainment that allows the allocation to the three categories, e.g. with regard to ISCED 3C short (less than 2 years of duration) which should be considered as low educational attainment.
- The expression "level successfully completed" must be associated with obtaining a certificate or a diploma, when there is a certification. Persons who have not completed their studies should be coded according to the highest level they have completed and should not be coded with a blank.

Col 204/207: Country of birth of father and mother

The first 2 digits correspond to the country of birth of the father and the 2 others to the country of birth of the mother. In the case of unknown country, code 00 for the mother or father should be used. The definition of parents should be the same as the one used in the previous variable.

This variable should be provided according to the coding given in Annex IV of the LFS explanatory notes (derived from ISO). If possible the exact country should be indicated; where this is not possible, one of the general groupings in bold print should be used. EU and EFTA Member States but also candidate and other European countries must be coded individually.

For the purpose of this question, current national boundaries should be considered, rather than any applying at the time of the respondent parents' birth. Some countries (those with colonial past or tradition of emigration) could add a variable on nationality at birth of parents with the aim to identify better foreign background of the young person: This variable is however optional.

Col 208: Orientation of the highest level of formal education attained (HATLEVEL)

This information will be collected only for persons with educational attainment at ISCED levels 2, 3 and 4.

Coding for this variable should be done together with the variables HATLEVEL and HATFIELD, using national classification of educational programmes, and preferably without asking any further questions.

The categories proposed are established according to the ISCED definitions applied in the UOE data collection and the VET (Vocational Education and Training) data collection as agreed by Member States (EUROSTAT/E3/2000/VET02, incl. a definition for VET).

1. General education: less than 25% of the programme content was vocational.
2. Vocational (and pre-vocational education): at least 25% of the programme content is vocational (specifically oriented towards a specific class of occupations or trades and leading to a labour-market relevant qualification).
 - *Vocational education and training mainly school-based*: at least 75% of the vocational education/training hours spent in a school, college or a training centre; the rest in a working environment (enterprise or other).

- *Vocational education and training mainly workplace based*: at least 75% of the vocational education/training hours spent in a working environment (enterprise or other); the rest in a school, college or a training centre.
- *Combination of school and workplace based vocational education and training* (e.g. dual system, alternate programmes): less than 75% of the vocational education/training hours spent in a school, college or a training centre, the rest in a working environment (enterprise or other) - remainder of the two above

If the information about the orientation of education can not be obtained directly from the list of programmes used for the variable HATLEVEL, indication done above on the criteria of distinction of different types of vocational education will be adopted to national situation with the aim to help the respondent. At least basic distinction between general and vocational education (code 1 versus 5) should be assured.

Col 209/214: Month and year of leaving formal education for the last time

"Leaving" means leaving studies in formal education for the last time before the interview, regardless of whether the programme was successfully completed or not and even though the interviewee can have the intention to return to education in the future ("interruption").

Due to the difficulties faced by some countries for the identification of the date of leaving formal education for the last time, bilateral contacts between National Statistical Institutes and Eurostat are strongly encouraged. Examples or remarks which might be of interest for other Member States are uploaded on the FAQ webpage in reference at the beginning of this document.

As this variable serves as a reference point and filter for the variables concerning the first job, it is very important to obtain this information and to reduce non-answers to minimum.

The first 2 digits should be used for the month and the 4 following digits for the year (example: 052005 corresponds to May 2005). In the case of unknown month, code 00 for the month should be used.

Col 215: Work during studies in formal education

The question should be asked to the persons who have already finished their formal education as well as to the current students. The whole period of studies should be taken into account (not only the last level of education).

"Work" means here a job for pay or profit, of a minimal duration of about 1 month per year, on average: this can be expressed as approximately 4 weeks full-time, 8 weeks part-time or 150 hours within a year (not as 1 month adding up all employment spells for the whole period of studies). The purpose being to avoid reporting on very minor jobs but without increasing the burden on respondents, a reference to at least one month for a given year would be acceptable.

Two main purposes justify this variable:

- to detect the 1st experience in the labour market (search for a job, schedules, pay..) which can have a positive impact on the entry into the labour market after the studies
- to distinguish the work performed as a part of the educational programmes completed (since this will not be possible for all countries via the variable HATVOC)

Code 1: "Work as part of educational programme" means that a workplace based element is a compulsory part of the curriculum, such as in apprenticeship or dual system programmes or compulsory internships. Working during school holidays should be coded 2.

Interruptions of studies should be those of at least one school/academic year.

Col 216/221: Month and year of start of the first job of more than 3 months after leaving formal education for the last time

Only jobs for pay or profit of more than 3 months should be taken into account. This job could have started before leaving education although it was still the first job after leaving education. In that case JOBSTART will be before STOPDATE. If the current job is a first job but of the duration of less than 3 months (counted in the reference week), code 000000 should be used. Apprenticeship/unpaid traineeship, compulsory military or community service and summer jobs should be excluded.

Labour Force Survey - United Kingdom

The first 2 digits should be used for the month and the 4 following digits for the year (ex: 052005 correspond to May 2005). In the case of unknown month code 00 for the month should be used.

Col 222/224: Duration of the first job of more than 3 months (after leaving formal education for the last time)

Only jobs for pay or profit of more than 3 months should be taken into account. This job could have started before leaving education although it was the first job after leaving education. In that case, the duration should be counted from JOBSTART. Apprenticeship/unpaid traineeship, compulsory military or community service and summer jobs should be excluded.

The question could be asked in terms of exact months first and in case of difficulties in time bands of 3 months could be proposed and the average point of the band could be provided.

Col 225: Method which allowed to find the first job of more than 3 months (after leaving formal education for the last time)

We are asking about the main successful method which allowed to find the first job.

Code 2 means that the person was informed of the existence of this first job by the Public Employment Services. The information can come directly or via the internet site of the PES.

Col 226/229: Occupation of the first job of more than 3 months (after leaving formal education for the last time)

The variable should be coded according to the ISCO 88-COM classification, at 3- or 4-(optional)-digits-level. For those countries that are not able to provide information at a 4 digit level the fourth digit should be coded '0'. We ask for the occupation when the first job started.

Col 230: Type of contract of the first job of more than 3 months (after leaving formal education for the last time)

Please see explanatory notes for the 2008 LFS explanatory notes for the variable STAPRO (professional status).

Employees with a temporary contract are employees whose main job will terminate either after a period fixed in advance, or after a period not known in advance, but nevertheless defined by objective criteria, such as the completion of an assignment or the period of absence of an employee temporarily replaced. In case that there was a probationary period when starting the job followed by a contract of unlimited duration, the job should nevertheless be reported as a permanent job.

This variable is about the type of the 1st contract, even it has changed after, but excluding probationary periods (see previous bullet). The distinction between full-time and part-time work should be made on the basis of a spontaneous answer given by the respondent.

Col 231: Main activity after leaving formal education for the last time and before starting the first job of a duration of at least 3 months

We are asking about the main activity. In case of various activities, respondent could choose the activity with the longest duration. Holidays after stopping education should be excluded (the question asks about the period after stopping formal education and after holidays if the person took them).

“Work” means a job for pay or profit. Unpaid apprenticeship should be included in "other reasons".

Col 232/237: Weighting factor

Columns 232/237 should be filled for the countries where the weighting factor for the LFS module 2009 is different to the weighting factor for the core LFS (e.g. proxies allowed in the core LFS but not for the module, specific non-response rate high for the module compared to the core LFS ...).

Col 238: Nationality at birth of father and mother (optional)

The first 2 digits correspond to the nationality of the father and the 2 others to the nationality of the mother. Nationality should be interpreted as citizenship. Citizenship is defined as the particular legal bond between an individual and his/her state acquired by birth or naturalisation, whether by declaration, option, marriage or other means according to national legislation. It corresponds to the country issuing the passport. The concept of nationality should not be mixed up with any concept of ethnic origin.

For persons with dual or multiple citizenships, and who hold the citizenship of the country of residence, that citizenship should be coded. In case of multiple citizenship, where it includes one citizenship of a member state of the European Union, that citizenship should be coded. In other situations the first answer of the respondent should be coded.

This variable should be provided according to the coding given in Annex IV of the LFS explanatory notes (derived from ISO). If possible the exact nationality should be indicated; where this is not possible, one of the general groupings in bold print should be used. EU and EFTA Member States but also candidate and other European countries must be coded individually.

Specifications of the 2008 ad hoc module on the labour market situation of migrants and their immediate descendants

Column	Code	Description	Filter
203/206		<i>Year of acquisition of citizenship</i> 4 digits	Everybody aged 15-74 and C17/18 = C170/171
	9996	Year unknown but national by acquisition	
	9997	National at birth	
	9998	National since the creation of the country/redefinition of borders	
	9999	Not applicable (person aged under 15 or over 74 or (person aged 15-74 and C17/18 ≠ C170/171))	
	Blank	No answer	
207/208		<i>Country of birth of father</i> <i>(For Germany: nationality/former nationality of father when he has in the reference week the German nationality)</i> For coding see ISO classification	Everybody aged 15-74
	98	Country unknown but father born abroad	
	99	Not applicable (person aged under 15 or over 74)	
	blank	No answer	
209/210		<i>Country of birth of mother</i> <i>(For Germany: nationality/former nationality of father when he has in the reference week the German nationality)</i> For coding see ISO classification	Everybody aged 15-74
	98	Country unknown but father born abroad	
	99	Not applicable (person aged under 15 or over 74)	
	blank	No answer	
211/212		<i>Total number of years of residence in host country</i>	Everybody aged 15-74 and C19/20 ≠ 00
	01-98	2 digits	
	99	Not applicable (person aged under 15 or over 74 and C19/20 = 00))	
	Blank	No answer	
213		<i>Main reason the person had for migrating (last migration)</i>	Everybody aged 15-74 and C19/20 ≠ 00 and (C162/165 – C11/14 – C19/20) ≥ 15
	1	Employment, intra-corporate transfer	
	2	Employment, job found before migrating other than code 1	
	3	Employment, no job found before migrating	
	4	Study	
	5	International protection	
	6	Accompanying family/family reunification	
	7	Family formation	
	8	Other	
	9	Not applicable (person aged under 15 or over 74 or (person aged 15-74 and C19/20 = 00) or (person aged 15-74 and C19/20 ≠ 00 and (C162/165 – C11/14 – C19/20) < 15))	
	Blank	No answer	
214		<i>Whether the duration of the current residence permit/visa/certificate is limited (optional for France)</i>	Everybody aged 15-74 and C17/18 ≠ C170/171
	0	Yes, less than 1 year	

Labour Force Survey - United Kingdom

Column	Code	Description	Filter
	1-5	Yes, number of years	
	6	Yes, limited duration of more than 5 years	
	7	Yes, but do not know the duration	
	8	No	
	9	Not applicable (person aged under 15 or over 74 or (person aged 15-74 and C17/18 = C170/171))	
	Blank	No answer	
215		<i>Whether current legal access to the labour market is restricted</i>	Everybody aged 15-74 and C17/18 ≠, C170/171 and (C24 = 1, 2 or C99 = 1, 2, 4 or (C99 = 3 and C116 = 1))
	1	Yes, access restricted to employment for specific employers/sectors/occupations	
	2	Yes, access restricted to self-employment	
	3	Yes, access not allowing self-employment	
	4	Yes, combination of 1 and 2	
	5	Yes, combination of 1 and 3	
	6	Yes, combination of 1 and 3	
	7	No	
	8	Does not know	
	9	Not applicable (person aged under 15 or over 74 or (person aged 15-74 and C17/18 = C170/171) or (person aged 15-74 and C17/18 ≠ C170/171 and C116 = 2, blank))	
	Blank	No answer	
216		<i>Use of facilities for establishing what highest qualification equates to in the host country system</i>	Everybody aged 15-74 and C19/20 ≠ 00 and (C24 = 1, 2 or C99 = 1, 2, 4 or (C99 = 3 and C116 = 1))
	1	Yes, established what qualification equates to	
	2	Yes, but not established what qualification equates to or procedure not yet completed	
	3	No, no need because highest qualification obtained in the host country	
	4	No, no need for reason other than code 3	
	5	No for other reason	
	9	Not applicable (person aged under 15 or over 74 or (person aged 15-74 and C19/20 = 00) or (person aged 15-74 and C19/20 ≠ 00 and C116 = 2, blank))	
	Blank	No answer	
217		<i>Need to improve host country language skills to get an appropriate job</i>	Everybody aged 15-74 and C19/20 ≠ 00 and (C24 = 1, 2 or C99 = 1, 2, 4 or (C99 = 3 and C116 = 1))
	1	Yes	
	2	No	
	9	Not applicable (person aged under 15 or over 74 or (person aged 15-74 and C19/20 = 00) or (person aged 15-74 and C19/20 ≠ 00 and C116 = 2, blank))	
	Blank	No answer	
218		<i>Main help received in the host country in finding the current job or setting up own business</i>	Everybody aged 15-74 and C24 = 1, 2
	1	Relatives/friends	
	2	Public employment office	
	3	Private employment agencies	
	4	Migrant or ethnic organisation	
	5	Other	
	6	None	
	9	Not applicable (person aged under 15 or over 74 or (person aged 15-74 and C24 = 3, 4, 5))	
	Blank	No answer	

Column	Code	Description	Filter
219/220		<i>Use of services for labour market integration in the two years following the last arrival</i>	Everybody aged 15-74 and C19/20 ≠ 00 and C19/20 ≤ 10 and (C162/165 – C11/14 – C19/20) ≥ 15
	01	Yes, contact with an adviser for job guidance/counselling or job search assistance	
	02	Yes, participation to labour market training/programmes	
	03	Yes, participation to host country language tuition	
	04	Yes, combination of 1 and 2	
	05	Yes, combination of 1 and 3	
	06	Yes, combination of 2 and 3	
	07	Yes, combination of 1, 2 and 3	
	08	No, not entitled to	
	09	No, for reason other than code 8	
	99	Not applicable (person aged under 15 or over 74 or (person aged 15-74 and C19/20 = 00) or (person aged 15-74 and C19/20 ≠ 00 and C19/20 > 10) or (person aged 15-74 and C19/20 ≠ 00 and C19/20 ≤ 10 and (C162/165 – C11/14 – C19/20) < 15))	
	Blank	No answer	
221/226		<i>Weighting factor for the 2008 LFS module (optional)</i>	Everybody aged 15-74
	0000 - 9999	Columns 220-223 contain whole numbers	
	00 - 99	Columns 224-226 contain decimal places	

Explanatory notes for LFS 2008 ad hoc module

Col 203/206: Year of citizenship acquisition

Citizenship is defined as the particular legal bond between an individual and his/her State, acquired by birth or naturalization, whether by declaration, option, marriage or other means according to the national legislation. Reference should always be made to existing citizenships.

Code 9998: expected in case of break-up of countries, redefinition of borders ...

About dual citizenship: This variable aims to know only about the citizenship of the host country. In case a migrant has a foreign citizenship but also acquired the citizenship of the host country, then the year of citizenship acquisition should be filled. In case a person had a dual citizenship at birth -a foreign and the host country citizenship-, then code 9997 (national at birth) applies.

Note: "National/non national" and "citizen/non citizen" of the host country have exactly the same meaning (legal aspect).

Col 207/208 and Col 209/210: Country of birth of father and mother

Information on the country of birth of parents (father and mother) should be asked for following the same indications given in the core LFS for the variable *Country of birth*. Current borders apply.

For coding, see Annex IV of the LFS explanatory notes. The coding to be used for columns 207/208 and 209/210 shall be the same as for columns 17/18, 21/22, 39/40 and 150/151 of the core LFS (Annex II to Commission Regulation (EC) No 430/2005).

Reference should be made to legal parents. In case of adoption, this recommendation would favour the parents of adoption. Indeed, adopted children are brought up in the host country and live in a family with "native" culture and traditions (perspective of integration).

Col 211/212: Total number of years of residence in the host country

Years during which person had residence (taking up residence, establishment) in the host country should be taken into account. For example, short visits for tourism or to see family should be excluded.

For persons with up to one year's residence in total in this Member State, 01 should be coded; between one year and two years, 02; ... (may be revised – see PL comment).

Only interruptions of residence of more than one year should be considered as an exit of the host country.

E.g.

* a person took up residence for 6 months and then went back to his/her country for 2 years and then took up residence again in the host country 2 years ago: the total duration is 2 ½ years and should be coded '03'.

* a person took up residence for 6 months and then went back to his/her country for 9 months and then took up residence again in the host country 5 years ago: the total duration is 6 years and 3 months and should be coded '07'.

Control of the data: C19/20 <= C211/212. In case the last arrival in order to take up residence is also the first one, the same code should be used for C19/20 and C211/212.

Col 213: Reason the person mostly had for migrating (last migration)

Main reason for migrating for the last migration (the most recent) should be recorded.

The individual reason that the person interviewed had for migrating is requested. Different reasons in the same household are expected (e.g. father = employment, mother and child = family).

In case where multiple reasons apply, the main reason should be recorded (spontaneous choice from the person interviewed). The main reason for migrating at the moment of the migration should be recorded.

'Real' reason for migrating (i.e. the one declared by respondents) should be asked for (and not legal reason). All response options should be shown/read out to the interviewed persons for a better harmonisation of the data collected.

Codes 1, 2 and 3: Entering the country with or without any job perspective has probably not the same impact on the labour market integration. It is important to have this information separately.

Code 3: Including search for job and including persons who intended to set up own business.

Code 4: Including trainees, apprentices, interns.

Code 5: "Forced" migration - Humanitarian migration, including political refugees, asylum seekers, other populations under protection (1951 Geneva Convention on refugee status; Other forms of international protection -temporarily protected, persons in asylum procedure etc.).

Code 6: It includes accompanying family (e.g. spouse/children) of an entering worker/student, entry of spouse and/or children of a resident. Nuclear family (parents, dependant children) is taken into account as well as other dependant parents and dependant close children relatives (the main criteria is the dependency criteria).

Code 7: Family formation, creation (marriage).

Code 8: "Other" should refer to other voluntary migration. E.g. retired persons who came in the host country for their retirement, migrations for the climate, for health reasons, for better medical or health services, less insecurity (outside code 5), "housing" reasons for frontier-worker migrants...

Col 214: Whether the duration of the current resident permit/visa/certificate is limited

Codes 1 to 6 are of most interest.

Any kind of authorisation issued by the authorities of a Member State allowing to stay legally in its territory should be taken into account (e.g. residence permit/visa/certificate). Visas often refer to short duration (normally less than 3 months but can be less than 1 year).

Labour Force Survey - United Kingdom

The duration refers to the total duration of the authorisation (total length of validity) and not to the duration which is still valid. In case of successive permits, the duration of the current permit should be taken into account.

Coding for situations where residence permits are formally limited but automatically prolonged: the formal situation (limitation) should be taken into account.

EU citizens are often allowed to stay in the MS for unlimited duration (sometimes with the establishment of a certificate). Code 7 should apply in these cases.

Countries should be able to filter out nationals of countries that are free to live in the host country without authorisation for unlimited durations. These cases should be coded 7.

When designing the questionnaire, special care has to be taken due to the sensitivity of the topic.

No recommendation is made at the European level concerning the coding of illegal migrants because of the sensitivity of this issue in some countries. Codes 1 to 6 are of most interest, the MS are free to leave the coding of illegal migrants as their legal statistical rules allow them.

Col 215: Whether current legal access to the labour market is restricted

Codes 1 to 5 have priority on code 6 'Other legal access restrictions'.

Code 6 includes any other kinds of legal restrictions not included in codes 1 to 5 (e.g. geographical restrictions, no access ...), except time restrictions (see C214).

The MS have the possibility to build this variable using information from the core LFS, when feasible and when information is available. E.g. national rules on migrants' legal access to the labour market may be specific for some kinds of population that may be identified using variables from the core LFS. The use of administrative data is also possible to the extent that information can be linked with LFS data.

When designing the questionnaire, special care has to be taken due to the sensitivity of the topic.

No recommendation is made at the European level concerning the coding of illegal migrants or legal migrants working illegally because of the sensitivity of this issue in some countries. The MS are free to leave the coding as their legal statistical rules allow them.

Col 216: Use of means for establishing what highest qualification equates to in the host country system

"Use of means": all national or international reputable providers of certificates clarifying what qualifications (obtained abroad) equate to in the host country system should be taken into account. E.g. national authorities, professional or university bodies, NARIC (National Academic Recognition Information Centre) ... Such procedures are included whether they are free or not.

"Qualification": including educational qualifications and professional qualifications (vocational/training) - as in the ISCED system.

Code 1: persons obtained a certificate/document establishing what qualification equates to in the host country system.

Code 4: e.g. person does not need such a certificate for the work he/she does/wishes to do ...

Code 5: e.g. person was not aware of any such possibility, person thought it is too complicated, procedure too expensive or time consuming ...

Col 217: Need to improve host country language skills to get an appropriate job

All host nation languages should be taken into account as well as other co-official languages.

Time dimension: current situation applies.

Labour Force Survey - United Kingdom

"Appropriate job": type of job person would normally do/search for if language skills were not an issue (i.e. more in line with their qualifications/skills/previous work experiences).

"Need": the need should be the focus and not the willingness.

Code 2 includes:

* Cases where persons' abilities in host country language(s) are good

* Cases where persons' abilities in host country language(s) are not good but where it is not a problem because his/her job is appropriate, or their language skills would, in their view, not affect their ability to get an appropriate job.

Col 218: Main help received in the host country in finding the current job or setting up own business

Codes 1 to 5:

* Should only be recorded help provided by persons living/organisations set up IN the host country. E.g. migrants helped by relatives living in the country of origin should be coded 6.

* Migrants that were helped by persons/organisations of the host country but before they arrived in the host country should be included. E.g. a migrant who found his job in the host country before migrating thanks to a relative living in the host country.

Code 6 includes:

* Cases where persons were helped by persons/organisations in the country of origin

* Cases where persons were not helped at all (including those who didn't need any help)

Public employment office: including private organisations mandated by public employment office.

'Other': e.g. employers, business contacts, commune ...

Col 219: Use of services for labour market integration in the 2 years following the last arrival

"Participation to labour market training/programmes": including work experience schemes, professional training programmes/integration programmes. Training programmes/measures to assist integration in labour market, including that specific to helping migrants adapt to the labour market in the host country (e.g. participation in work experience schemes, vocational training).

"Participation to host country language tuition": reading/writing/speaking/understanding.

Public and private services should be included. E.g. services provided by public employment office or by other public services, services provided by associations, employers, Trade Unions ...

"Use of services for labour market integration": e.g. students who were in school without having used services for labour market integration are excluded from codes 1 to 7.

Code 8 'No, not entitled to': means no due to legal barriers.

Col 220/225: Weighting factor for the LFS module 2008

Columns 220/225 should be filled for the countries where the weighting factor for the LFS module 2008 is different to the weighting factor for the core LFS (e.g. proxies allowed in the core LFS but not for the module, specific non-response rate high for the module compared to the core LFS ...).

Specifications of the 2007 ad hoc module on accidents at work and work-related problems

Column	Code	Description	Filters/remarks
		ACCIDENTS AT WORK ENCOUNTERED BY PERSONS HAVING WORKED IN THE LAST 12 MONTHS	
209	0 1 2 9 blank	<i>Accidental injury(ies), apart from illnesses, occurred during the past 12 months, at work or in the course of work</i> None One Two or more Not applicable (Col.24 = 3-9 and (Col.84 ≠ 1 or (Col.85/88 and Col.89/90 is more than one year before the date of the interview, or is blank))) No answer	(Col.24 = 1,2) or (Col.84 = 1 and Col.85/88 and Col.89/90 is not prior to one year before the date of the interview)
210	1 2 9 blank	<i>Type of the most recent accidental injury at work or in the course of work</i> A road traffic accident Accident other than road traffic accident Not applicable (col.209=0, 9, blank) No answer	Col.209 = 1-2
211/212	00 01 02 03 04 05 06 07 08 09 10 99 blank	<i>Date when the person was able to start to work again after the most recent accidental injury</i> Still off work because has not yet recovered from the accident, but expects to resume work later Expects never to work again because of the accident No time off or the same day as the accident The day after the accident From the second but before the fifth day after the accident From the fifth day but before two weeks after the accident From two weeks but before one month after the accident From one month but before three months after the accident From three months but before six months after the accident From six months but before nine months after the accident Nine months or later after the accident Not applicable (Col.209 = 0, 9 or blank) No answer	Col.209 = 1-2
213	1 2 3 4 5 9 blank	<i>Job done when the most recent accidental injury occurred (code first that applies)</i> Main current (first) job Second current job Last job (person not in employment) Job one year ago Some other job Not applicable (Col.209 = 0, 9, blank) No answer	Col.209 = 1-2

Labour Force Survey - United Kingdom

Column	Code	Description	Filters/remarks
WORK-RELATED HEALTH PROBLEMS SUFFERED DURING THE LAST 12 MONTHS (apart from accidental injuries)			
214		<i>Illness(es), disability(ies) or other physical or psychic health problem(s), apart from accidental injuries, suffered by the person during the past 12 months (from the date of the interview) and that was (were), caused or made worse by work</i>	(Col.24 = 1,2 or Col.84 = 1)
	0	None	
	1	One	
	2	Two or more	
	9	Not applicable (Col.24 = 3-9 and Col.84 ≠1)	
	blank	No answer	
215/216		<i>Type of the most serious complaint caused or made worse by work</i>	Col.214 = 1-2
	00	Bone, joint or muscle problem which mainly affects neck, shoulders, arms or hands	
	01	Bone, joint or muscle problem which mainly affects hips, legs or feet	
	02	Bone, joint or muscle problem which mainly affects back	
	03	Breathing or lung problem	
	04	Skin problem	
	05	Hearing problem	
	06	Stress, depression or anxiety	
	07	Headache and/or eyestrain	
	08	Heart disease or attack, or other problems in the circulatory system	
	09	Infectious disease (virus, bacteria or other type of infection)	
	10	Other types of complaint	
	99	Not applicable (Col.214 = 0, 9, blank)	
	blank	No answer	
217		<i>Whether the most serious complaint caused or made worse by work limits the ability to carry out normal day to day activities either at work or outside work</i>	Col. 214 = 1-2
	0	No	
	1	Yes, to some extent	
	2	Yes, considerably	
	9	Not applicable (Col.214 = 0, 9, blank)	
	blank	No answer	
218/219		<i>Number of days off work during the last 12 months due to the most serious complaint caused or made worse by work</i>	Col.214 = 1-2
	00	The person has not been working during the past 12 months, but for reasons not related to the complaint caused or made worse by work (e.g. normal retirement)	
	01	Expects never to work again due to this illness	
	02	Less than one day or no time off	
	03	At least one day but less than four days	
	04	At least four days but less than two weeks	
	05	At least two weeks but less than one month	
	06	At least one month but less than three months	
	07	At least three months but less than six months	
	08	At least six months but less than nine months	
	09	At least nine months	
	99	Not applicable (Col.214 = 0, 9, blank)	
	blank	No answer	

Labour Force Survey - United Kingdom

Column	Code	Description	Filters/remarks
220		<i>Job that caused or made worse the most serious complaint (code first that applies)</i>	Col.214 = 1-2 and (Col.85/88 is not prior to eight years before the year of the interview)
	1	Main current (first) job	
	2	Second current job	
	3	Last job (person not in employment)	
	4	Job one year ago	
	5	Some other job	
	9	Not applicable (Col.214 = 0, 9, blank)	
	blank	No answer	
FACTORS AT WORK THAT CAN ADVERSELY AFFECT MENTAL WELL-BEING OR PHYSICAL HEALTH			
221		<i>Whether at the workplace the person has particular exposure to selected factors that can adversely affect his/her mental well-being</i>	Col.24 = 1,2
	0	No	
	1	Yes, mainly to harassment or bullying	
	2	Yes, mainly to violence or threat of violence	
	3	Yes, mainly to time pressure or overload of work	
	9	Not applicable (Col 24 = 3-9)	
	blank	No answer	
222		<i>Whether at the workplace the person has particular exposure to selected factors that can adversely affect his/her physical health</i>	Col.24 = 1,2
	0	No	
	1	Yes, mainly to chemicals, dusts, fumes, smoke or gases	
	2	Yes, mainly to noise or vibration	
	3	Yes, mainly to difficult work postures, work movements or handling of heavy loads	
	4	Yes, mainly to risk of accident	
	9	Not applicable (Col 24 = 3-9)	
	blank	No answer	

Explanatory notes for LFS 2007 ad hoc module

Col 209: Accidental injury(ies), apart from illnesses, occurred during the past 12 months, at work or in the course of work

Only those accidents that occurred at work or in the course of the work of the interviewed person are considered. All other types of accidents are excluded:

- accidents occurred in the course of travelling between home (usual place of meals also) and the workplace (commuting accidents),
- home and leisure accidents
- road traffic or transport accidents in the course of private activities.

Occupational diseases or illnesses are also excluded. An accident is a discrete occurrence, illnesses or other health conditions which develop over a long time should not be included. In some rare cases it may be difficult to make a difference. For example if a health care worker has a needle stick injury and develops an infectious disease as a consequence, the onset is accidental and it should be considered as an accident. If a construction worker injures his back as a consequence of a sudden movement, it should be considered as an accident. While if a back pain develops over one day when he was carrying heavy loads, it should be seen as a non-accidental work-related health problem (col 214). The concept of an accident includes also cases of acute poisoning and wilful acts of other persons. However, deliberate self-inflicted injuries are excluded.

The term "in the course of work" means "whilst engaged in an occupational activity or during the time spent at work". Any accident occurred during working time, even if it has not occurred during the usual work or in the usual workplace of the person, has to be taken into consideration. From this follows that, during work, all types of accidents in a public place or means of transport, either if it is the usual workplace or during a journey in the course of work, should be considered as an accident at work and are included.

This applies also to the following types of accidents: road traffic accidents in the course of work; slips, falls, aggressions, etc., in public places (pavement, staircases, etc.) or in the arrival and starting points (station, port, airport, etc.) of any means of transport occurred in the course of work; accidents on board of any means of transport used in the course of work (underground railway, tram, train, boat, plane, etc.), accidents occurring during a mission done for work and accidents occurred in the course of work within the premises of another company than the one which employs the victim, or in a private individual in the course of work. Finally, accidents at lunch time, or any other break, inside the premises of the enterprise should also be included (while if the person leaves the premises of the company to go for a lunch at home or other outside location, the accident happening during this journey should be considered as a commuting accident and should not be included). All cases of accidents corresponding to these examples are considered as "accidents at work". Please notice that if the person goes for a mission directly from home (without going first to his usual workplace), he/she is on mission already when leaving home and consequently any accidents occurring should be included.

The last 12 months are taken into consideration from the date of the interview (ex: accidents between the 15 April N-1 and the 14 April N for an interview the 14 April N).

When the person suffered more than one accident at work during the last 12 months, the code "2 Two or more" has to be used.

Finally, it should be noted that the question covers all those aged 15 years or more and fulfilling the filter (Col.24=1,2 or (Col.84=1 and ...)), while there is no upper limit of age for old people.

Col 210: Type of the most recent accidental injury at work or in the course of work

Please remind that only those accidents that occurred at work or in the course of the work of the interviewed person are considered. All other types of accidents are excluded: as accidents occurred in the course of travelling between home (usual place of meals also) and the workplace (commuting accidents), home and leisure accidents or road traffic accidents or other transport accidents in the course of private activities.

Road traffic accidents include all accidents (at work or in the course work) in public roads, public or private car parks provided the accident happens in the course of work. The victim may be either on board of a means of transport (driver or passenger) or a pedestrian. Road traffic accidents include both accidents in which the victim's main professional activity is related to the transport (e.g. lorry or bus drivers) and accidents in which the victim was occasionally in road traffic in the course of work (e.g. a manager going on his/her way to a business meeting outside of the enterprise).

All other accidents at work should be coded by Code 2. This applies also to accidents that are related to machines which are used outside of the public roads (e.g. forklift trucks, bulldozers, tractors in farming fields, forestry-related machines in forests, etc.). If such a machine was on a public road at the time of the accident, it should, however, be coded with Code 1. Accidents that happen inside the premises of the company on non-public roads within the factory area are also coded with code 2 (they are not considered as road traffic accidents).

Col 211/212: Date when the person was able to start to work again after the most recent accidental injury

This variable defines the number of days lost due to the accident for those cases where the victim either has started work or has already recovered from the accidental injury. All days when the person was unfit for work from the day of the accident until the resumption of work have to be taken into consideration (normal working days or not, including Sundays, bank holidays, etc.). If the victim has not, at the day of the interview, recovered from the accidental injury, there are two possible detailed categories: Code 00 for those who expect to resume work later and Code 01 for those who expect never to work again because of the accident.

Only days lost strictly related to the inability to work resulting from the accidental injury have to be counted. Consequently, when the victim has already recovered from the accidental injury but has not worked again at the day of the interview, the Code 00 should not be used. Instead the person should estimate the date when he/she could have started to work (i.e. had recovered from the accident).

When calculating the days for those who have already returned to work, days when the person was able to work but did not do it due to other reasons should not be taken into consideration (even if the reason is somehow linked with the accident). For example if the person was unfit to work during 2 months due to the accident, but was made redundant due to the physical consequences of this accident, and found a new job only 8 months after the accident, the code is '07' = "from one month but before three months after the accident" (2 months).

If the person didn't work for a certain period of time and then started to be integrated back to work gradually, for example working part-time, only the days when he/she was not working at all are counted.

Finally, it should be noted that the periods off work considered in this variable and the similar variable for work-related non-accidental health problems (Col 218/219) are the same, but variable 211/212 considers the date of resumption of work and variable 218/219 the number of days lost. That induces a difference of one day in the labels of the codes, but not in the period of absence considered. For example, for code '05', a resumption of work from the fifth day but before two weeks after the accident, means a number of days lost of at least four days but less than two weeks.

Col 213: Job done when the most recent accidental injury occurred (code first that applies)

The job can be the main current (first) job, code '1', that means the job described in columns 27 to 55 of the 2006 codification, or the second current job, code '2', described in columns 78 to 83. The job can also be either the last job if the person is not in employment (job described in columns 85 to 98), code '3', or the job one year before the survey (columns 147 to 149), code '4'. If the job is at the same time the last one and the job one year ago, the job has to be coded as the last one, code '3' ("code first that applies"), in order to allow to analyse a possible link between the accident and the main reason for having left this last job (column 91/92).

Finally, if the job is none of these, the answer is "some other job", code '5'. This code also applies in situations where a second job existed at the time of the "last job" or "job one year ago" and the accident occurred in this second job.

Col 214: Illness(es), disability(ies) or other physical or psychic health problem(s), apart from accidental injuries, suffered by the person during the past 12 months (from the date of the interview) and that was (were), caused or made worse by work

The reference period is the 12 months prior to the date of the interview. This period includes the date of the interview (ex: complaint suffered at any moment between the 15 April N-1 and the 14 April N for an interview the 14 April N).

Any complaint suffered by the person during the 12 months reference period has to be included if the person considers himself/herself that this complaint is caused or made worse by work (past or current). This means that the work-related problems asked for should not be restricted to cases reported or recognised by the authorities, but all cases even those without time off work should be included provided the above criteria are satisfied. In infectious diseases, like a common cold or flu, it is difficult for the person to identify where and when exactly (work, home, elsewhere) occurred the transmission of the causative infectious agent (virus, bacteria etc.). In such diseases the advice to the person interviewed is to think whether the nature of his/her work is such that it would have caused the disease (i.e. that in this work it would be more probable to have such a disease in comparison to the everyday life environment or other types of work).

Any work at any time, even years back in time, has to be taken into consideration. In the latter case, the onset of the health problem could have been more than a year before the interview, but if the victim still suffered from this problem during the 12 months reference period, it should be taken into consideration. But, if the victim has not suffered from the work-related health problem during the 12 months reference period the case should not be included.

In cases where the person suffered from more than one illness, disability or other physical or psychic health problem during the past 12 months, that were caused or made worse by work, apart from accidental injuries, the code 2 Two or more has to be used (cumulating complaints caused and complaints made worse by work, without distinction).

Finally, as mentioned above for Col.209, it should be noted that the question covers all those aged 15 years or more and fulfilling the filter (Col.24=1,2 or Col.84=1), while there is no upper limit of age for old people.

Col 215/216: Type of the most serious complaint caused or made worse by work

In cases where the person suffered from more than one work-related health problem during the 12 months reference period, only the most serious of these is considered for this and the following variables. In this assessment there should be no distinction between complaints caused by work and those made worse by work, only seriousness of the complaint should be assessed. There is of course a subjective element in such an assessment of the “most serious” of the health problems related to work. Nevertheless, it should be the complaint most severe from a medical point of view, in general the complaint which had the biggest impact on his/her activities.

As there is no specific code for cancers, they should be coded, if possible, according to the anatomical location (lung cancer into "03 Breathing or lung problems" and skin cancer into "04 Skin problems". If this is not possible, then the code "10 other types of complaint" should be used (for example in case of cancers of the intestinal organs).

Col 217: Whether the most serious complaint caused or made worse by work limits the ability to carry out normal day to day activities either at work or outside work

The complaint refers to the most serious complaint caused or made worse by work, while the limitation in day to day activities covers also day to day activities outside work. E.g. if a skin problem caused or made worse by work considerably limits the person's day to day activities at home, it should be coded as 2- Yes, considerably.

Col 218/219: Number of days off work during the last 12 months due to the most serious complaint caused or made worse by work

This variable concerns the number of days of work lost due to the most serious complaint related to work. All days in between the onset of the complaint and the resumption of work have to be taken into consideration (normal working days or not, including Sundays, bank holidays, etc.).

The variable only covers the days lost strictly related to the complaint. In particular, if there is more than one complaint, only the days lost due to the most serious one are taken into consideration. In the same way, all the other absences from work during the last 12 months, in particular due to any illness not related to work, or to an accident at work, or to any other type of accidents (home and leisure accidents or road traffic accidents not in the course of work), have to be excluded.

Only the absence during the 12 months period prior to the date of the interview is considered. If the person had time off work before this period, even if this absence was in a continuous connection with the absence occurred during the period of the last 12 months, only the days off work during the 12 months reference period have to be counted as days lost. Additionally, if there were several absences from work due to the most serious complaint during the last 12 months, they have to be cumulated. For example, the interview takes place the 14 April N, and the person was off work because of the complaint from the 1st April N-1 to the 30 April N-1, from the 1 to the 20 September N-1 and from the 10 April N to the date of the interview, with a work stop prescribed until the 20 April N, the number of days taken into consideration is : 16 (only from the 15 to the 30 April N-1) + 20 (in September N-1) + 5 (from the 10 to the 14 April N only) = 41 days lost = code '06' = “at least one month but less than three months”. If the person is off work at the time of the interview and because of the most serious complaint caused or made worse because of work (but expects to resume work later), then the absence should be counted until the date of the interview (within the time limit of the past 12 months).

If the person didn't work for a certain period of time and then started to be integrated back to work gradually, for example working part-time, only the days when he/she was not working at all are counted.

Moreover, if the person was not working at all during the whole 12 months' reference period, due to other reasons than the complaint, either he/she was in training, holidays, slack work, maternity leave, unemployed, ill or retired, etc., the code 00 should be used.

Finally, when the person expects, at the date of the interview, never to work again due to the most serious complaint, this variable has to be coded '01'="Expects never to work again due to this illness", whatever the actual number of days off work due to the complaint during the last 12 months (that otherwise would have been coded using one of the categories 02 to 09).

As mentioned above for Col 211/212, it should be noted that the period off work considered in the variables 211/212 and 218/219 are the same, but variable 211/212 considers the date of resumption of work and variable 218/219 the

(cumulated) number of days lost. That induces a difference of one day in the labels of the codes, but not in the period of absence considered. For example, for code '05' in Col 211/212, a resumption of work from the fifth day but before two weeks after the accident, means a number of days lost of at least four days but less than two weeks.

Col 220: Job that caused or made worse the most serious complaint (code first that applies)

The job can be the main current (first) job, code '1', that means the job described in columns 27 to 55 of the 2006 codification, or the second current job, code '2', described in columns 78 to 83. The job can also be either the last job if the person is not in employment (job described in columns 85 to 98), code '3', or the job one year before the survey (columns 147 to 149), code '4'. If the job is at the same time the last one and the job one year ago, the job has to be coded as the last one, code '3' ("code first that applies"), in order to allow to analyse a possible link between the complaint and the main reason for having left this last job (column 91/92).

Finally, if the job is none of these, the answer is "some other job", code '5'. This code also applies in situations where a second job existed at the time of the "last job" or "job one year ago" and the complaint was caused or made worse by this second job. People reporting a complaint caused or made worse by a previous job, but having not worked during the last 8 years are not included in the filter because for them the job that caused or made worse the complaint is by definition '5- Some other job'. This codification should be used for those who are filtered out due to the condition of not having worked during the last 8 year, but still reporting a complaint in col 214.

Col 221: Whether at the workplace the person has particular exposure to selected factors that can adversely affect his/her mental well-being

The approach is to consider the workplace exposure and the mental well-being from the point of view of the worker him/herself. Workplace refers to the usual geographical environment of work, usually it is the local unit or establishment where the respondent carries out his/her work activities, but for certain workers (e.g. forestry workers, firemen) it should be taken as the general environment where the work is usually carried out. Exposure refers to existence of the mentioned factors (harassment or bullying, violence or threat of violence, etc.) that may adversely affect the mental well-being of the worker. Particular exposure refers to an exposure which is clearly more frequent or more intensive than people experience in general day to day life. The factors (e.g. harassment or violence) may be due to either other people working in the same workplace or clients etc. not working but visiting the workplace. The question concerns exposure only to the mentioned factors and in case there is a particular exposure to several of these the respondent should indicate which of these factors he/she considers as the main factor from the point of view of adverse effects on his/her mental well-being. The following definitions apply to the exposures mentioned:

- Harassment and bullying refer to intentional use of power against another person or group that can result in harm to physical, mental, spiritual, moral or social development (a term psychological violence is also sometimes used and is included in this category).
- Violence refers to physical force against another person or group that results in physical, sexual or psychological harm. Both real experiences of such actions and a feeling of the threat of such actions are covered by the code 2.
- Time pressure and overload or work refer to demands concerning either the time during which the work needs to be executed or demands concerning the amount of work to be executed and these demands going beyond the abilities and resources of the person.

Col 222: Whether at the workplace the person has particular exposure to selected factors that can adversely affect his/her physical health

The approach is to consider the exposure and the physical health from the point of view of the worker him/herself. Workplace refers to the usual geographical environment of work, usually it is the local unit or establishment where the respondent carries out his/her work activities, but for certain workers (e.g. forestry workers, firemen) it should be taken as the general environment where the work is usually carried out. Exposure refers to handling, touching, inhaling etc. of agents (chemicals, dusts, fumes etc.) or existence of other types of factors (work postures, movements, vibrations, noise, risk of accidents etc.) that may adversely affect the physical health of the workers. Particular exposure refers to an exposure which is clearly more frequent or more intensive than what people experience in general day to day life. Physical health refers to all other aspects of health than mental health. The question concerns exposure only to the mentioned factors and in case there is a particular exposure to several of these the respondent should indicate which of these factors he/she considers as the main factor from the point of view of adverse effects on his/her physical health.

Section 9:
EUROSTAT DERIVED VARIABLE FLOWCHARTS

In order to meet EuroStat regulations described earlier, the UK LFS dataset is delivered to agreed specification. The EuroStat variables are derived from the domestic LFS variables. This section explains how the EuroStat variables are derived using flow charts. Other LFS User Guides that are related to the EuroStat variables can be found at: www.statistics.gov.uk/StatBase/Product.asp?vlnk=1537&Pos=1&ColRank=2&Rank=272

Column	Description
1/2	Sequence number within household
3	Relationship to reference person in the household
4/5	Sequence number of spouse or cohabiting partner
6/7	Sequence number of father
8/9	Sequence number of mother
10	Sex
11/14	Year of birth
15	Date of birth in relation to end of reference week
16	Marital Status
17/18	Nationality
19/20	Years of residence in this country
21/22	Country of birth
23	Nature of participation in survey
24	Labour status during reference week
25/26	Reason for not having worked at all though having a job
27	Professional status
28	Continuing receipt of wage or salary
29/31	Economic activity of the local unit
32/35	Occupation
36	Supervisory responsibilities
37/38	Number of persons working at local unit
39/40	Country of place of work
41/42	Region of place of work (NUTS2)
43/46	Year which person started working for employer or self-employed
47/48	Month started with current employer or self-employed
49	Involvement of public employment office in finding present job
50	Full-time/part-time distinction
51	Reasons for the part-time work
52	Permanency of first job
53	Reasons for having temporary job/work contract of limited duration
54	Total duration of temporary job or work contract of limited duration
55	Contract with a temporary employment agency
56	Shift work
57	Evening work
58	Night work
59	Saturday work
60	Sunday work
61/62	Number of hours per week usually worked in the main job

Variable	Description
63/64	Number of hours actually worked during reference week in the main job
65/66	Paid overtime in reference week in the main job
67/68	Unpaid overtime in reference week in the main job
69/70	Main reason hours actually worked differed from usual hours worked
71	Willingness to work more hours
72	Way that a person can work more hours
73/74	Number of hours would like to work in total
75	Working at home
76	Looking for another job
77	Main reason for looking for another job
78	Existence of more than one job or business
79	Professional status in second job
80/81	Economic activity of the establishment in second job
82/83	Number of hours actually worked during reference week in second job
84	Previous employment experience
85/88	Year in which person last worked
89/90	Month in which person last worked
91/92	Main reason for leaving last job or business
93	Professional status in last job
94/95	Economic activity of the local unit in last job
96/98	Previous job occupation
99	Seeking employment during previous four weeks
100	Reasons for not seeking employment
101	Type of employment sought (or found)
102	Duration of search for employment
103	Contacted public employment office to find work
104	Contacted private employment office to find work
105	Applied to employers directly
106	Asked friends, relatives, trade unions etc.
107	Inserted or answered adverts in newspapers or journals
108	Studied adverts in newspapers or journals
109	Took a test, interview or examination
110	Looked for land, premises or equipment
111	Looked for permits, licenses or financial resources
112	Awaiting results of job application
113	Waiting for a call from a public employment office
114	Awaiting results of a competition for recruitment to public sector
115	Other job search method used
116	Willingness to work for persons not seeking employment
117	Availability to start work within two weeks
118	Reasons for not being available to start work within two weeks
119	Situation immediately before seeking work
120	Need for care facilities
121	Registration at a public employment office
122	Main status
123	Student or apprentice in regular education during last 4 weeks

Variable	Description
124	Level of the current education or training
125/127	Field of this education or training
128	Attendance at taught learning activities in last four weeks
129/131	Number of hours spent on all taught learning activities within last four week
132	Purpose of the most recent taught learning activity
133/135	Field of the most recent taught learning activity
136	Whether the most recent taught learning activity took place during paid working hours
137/138	Highest level of education or training successfully completed
139/141	Field of highest level of education or training successfully completed
142/145	Year when highest level of education or training successfully completed
146	Situation with regard to economic activity one year ago
147	Professional status one year ago
148/149	Economic activity of the local unit which person was working one year ago
150/151	Country of residence one year before survey
152/153	Region of residence one year ago (NUTS2)
154/155	Monthly (take home) pay from main job
156/159	Year of survey
160/161	Reference week
162/163	Interview week
164/165	Country
166/167	Region of household (using NUT2)
168	Degree of urbanisation
169/174	Serial number of household
175	Type of household
176	Type of institution
177/182	Yearly weighting factor
183/188	Quarterly weighting factor
189/194	Household yearly weighting factor
195	Sequence number of the survey wave
196	Questionnaire used

HHSEQNUM (EPERSNO): Sequence number within household

Columns 1/2

PAGE 1 OF 1

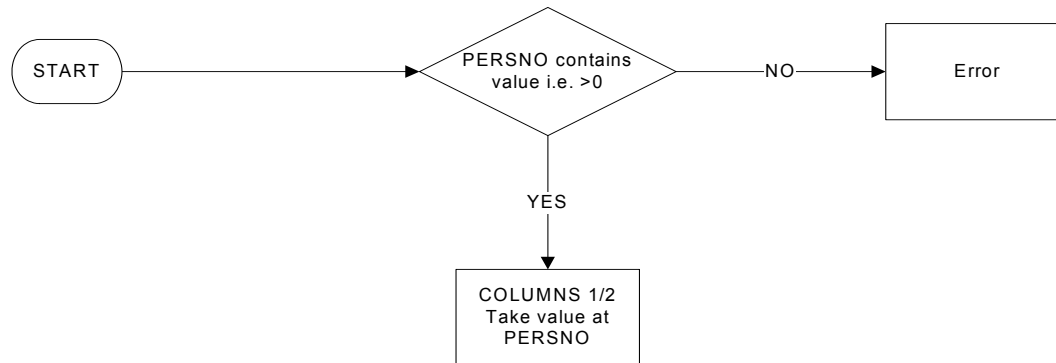

KEY	
01 - 98	Two-digit sequence number allocated to each member of the household

HHLINK (ERELHOH): Relationship to reference person in the household

Column 3

PAGE 1 OF 2

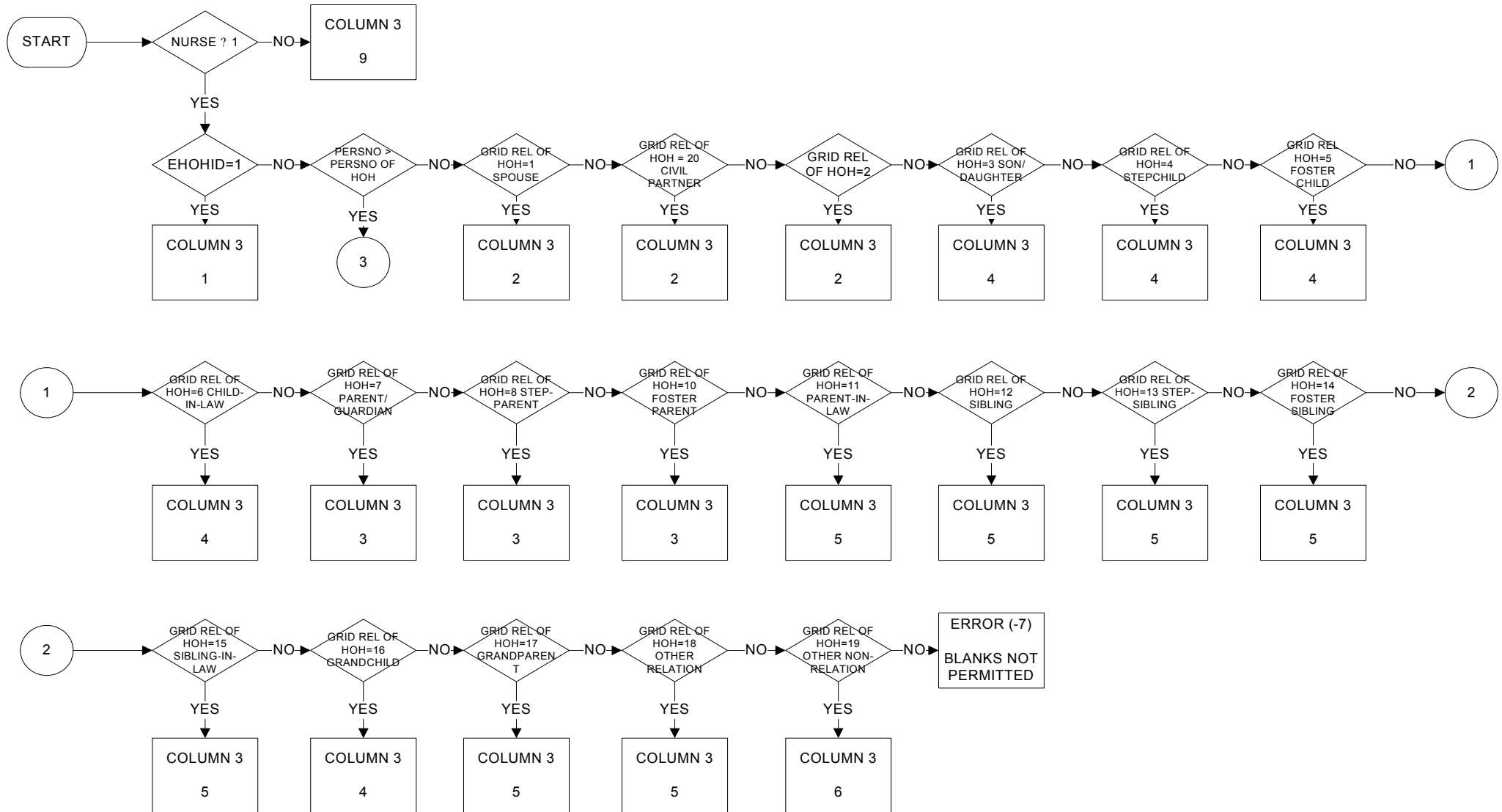

HHLINK (ERELHOH): Relationship to reference person in the household

Column 3

PAGE 2 OF 2

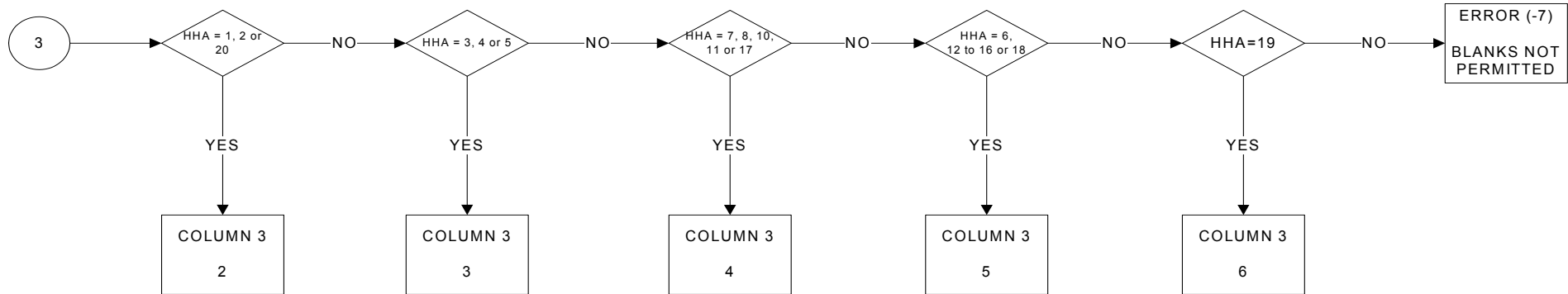

KEY	
1	Reference person
2	Spouse (or cohabiting partner) of reference person
3	Child of reference person (or of his/her spouse or cohabiting partner)
4	Ascendent relative of reference person (or of his/her spouse or cohabiting partner)
5	Other relative
6	Other
9	Not applicable (HHTYPE ? 1, 3)

HHSPOU (ESPOUSE): Sequence number of spouse or partner

Columns 4/5

PAGE 1 OF 2

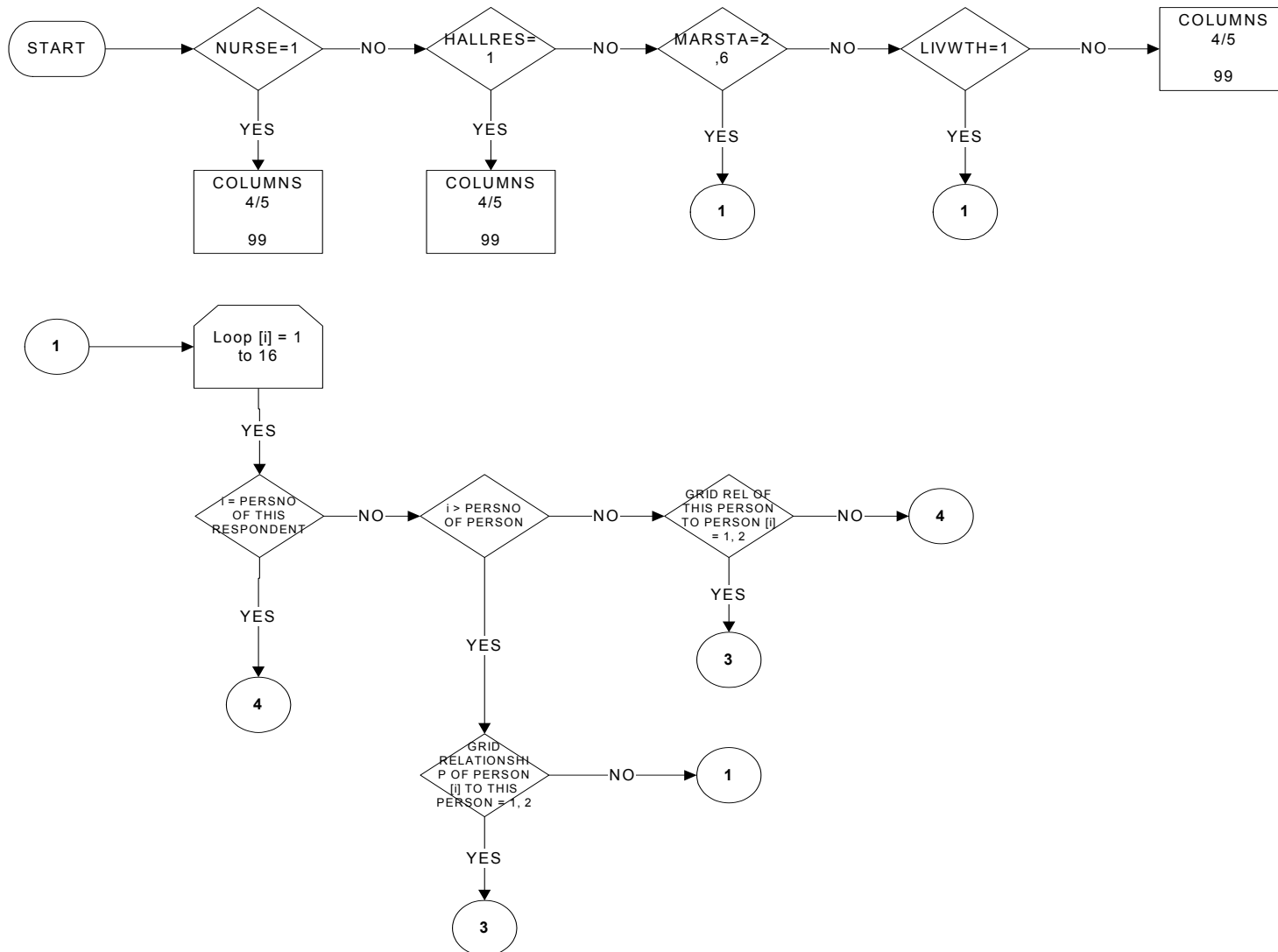

HHSPOU (ESPOUSE): Sequence number of spouse or partner

Columns 4/5
PAGE 2 OF 2

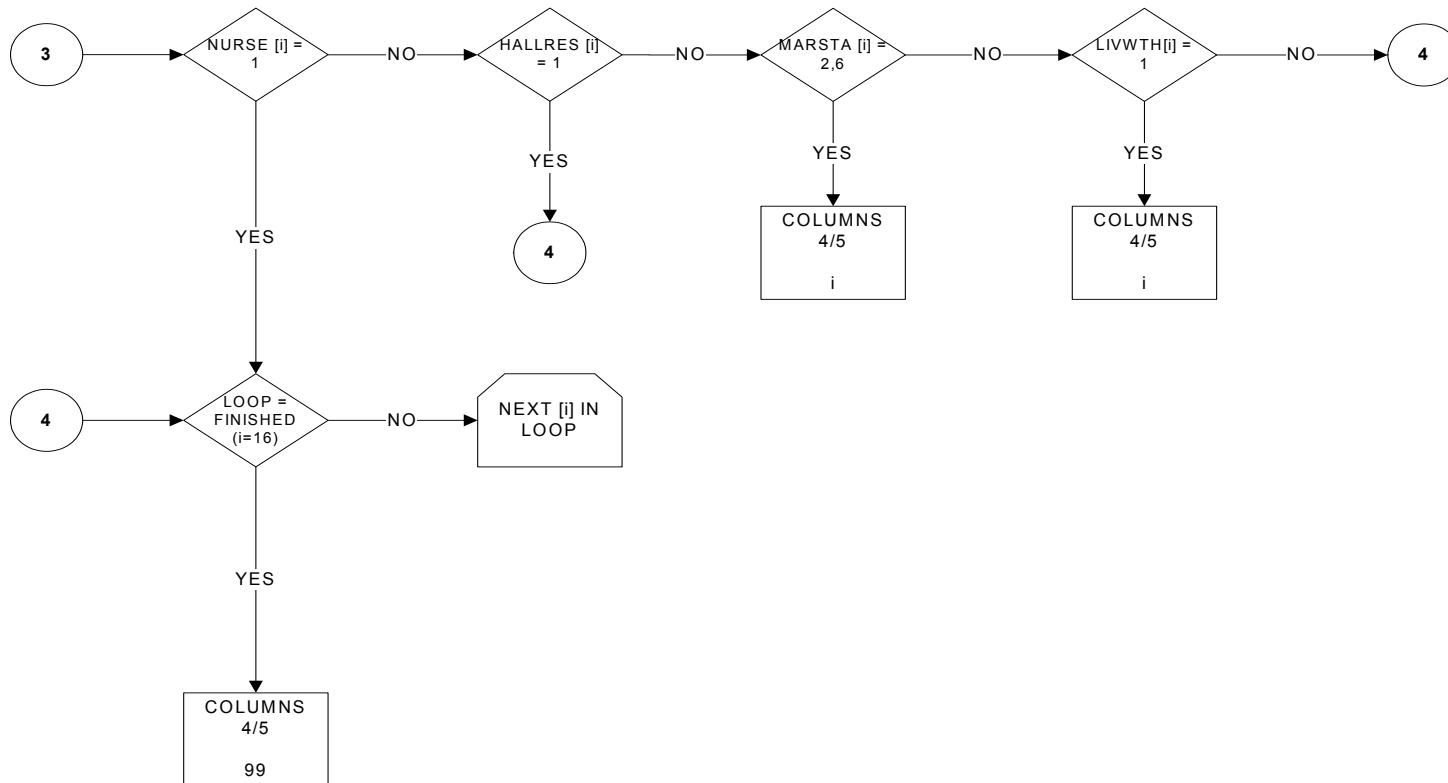

KEY	
01-98	Sequence number of spouse or cohabiting partner in the household
99	Not applicable (person does not belong to a private household, or has no partner, or the partner does not belong to this private household)

HHFATH (EFATHER): Sequence number of father

Columns 6/7

PAGE 1 OF 1

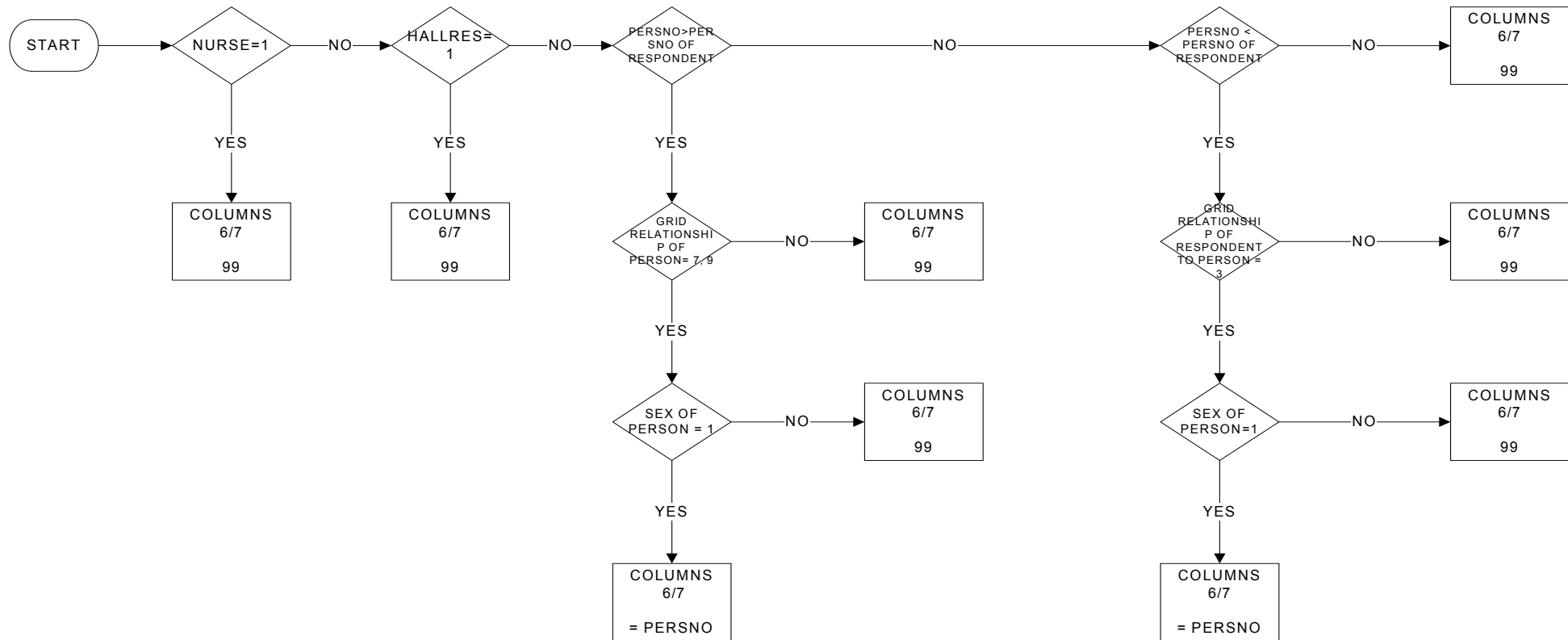

KEY	
01 - 98	Sequence number of father in the household
99	Not applicable (person does not belong to a private household, or the father does not belong to this private household)

HHMOTH (EMOTHER): Sequence number of mother

Columns 8/9
PAGE 1 OF 1

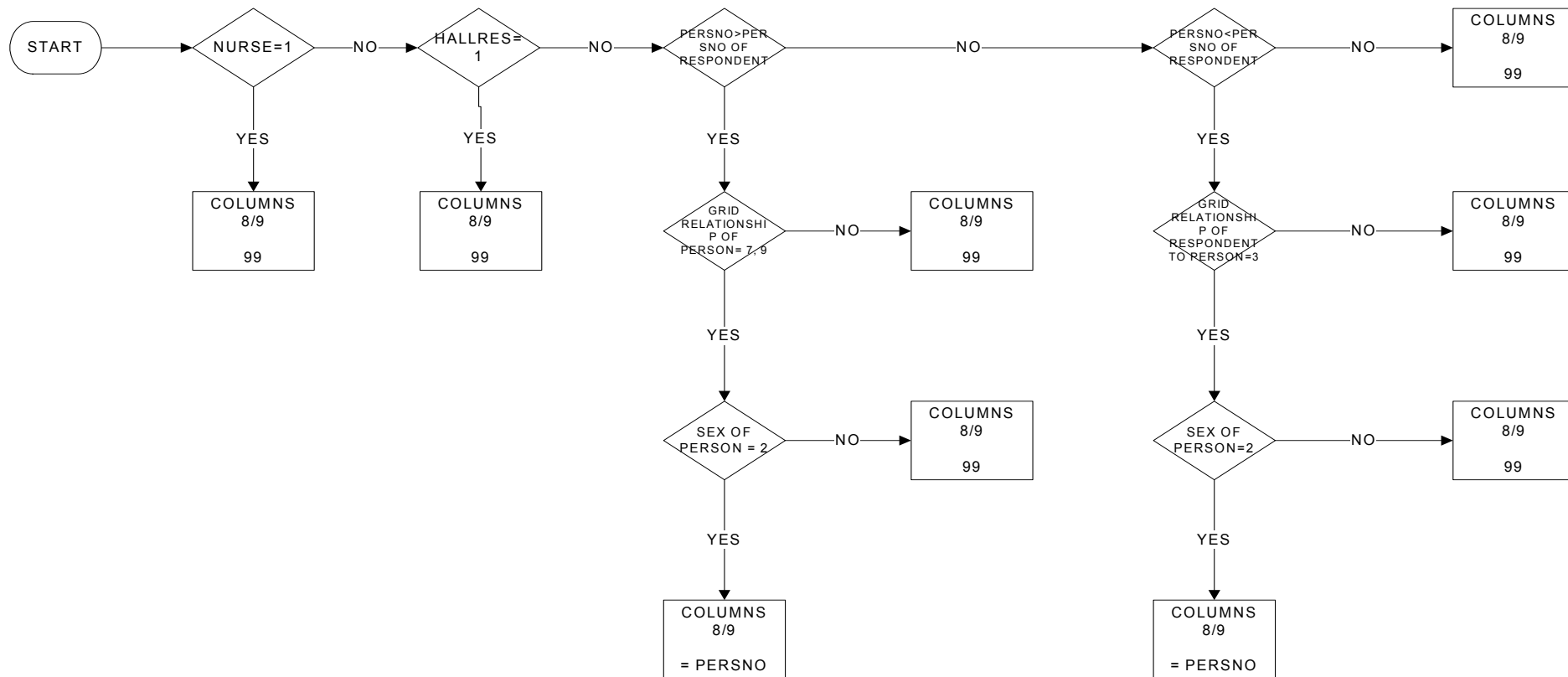

KEY	
01 - 98	Sequence number of mother in the household
99	Not applicable (person does not belong to a private household, or the mother does not belong to this private household)

SEX (ESEX): Sex
Column 10
PAGE 1 OF 1

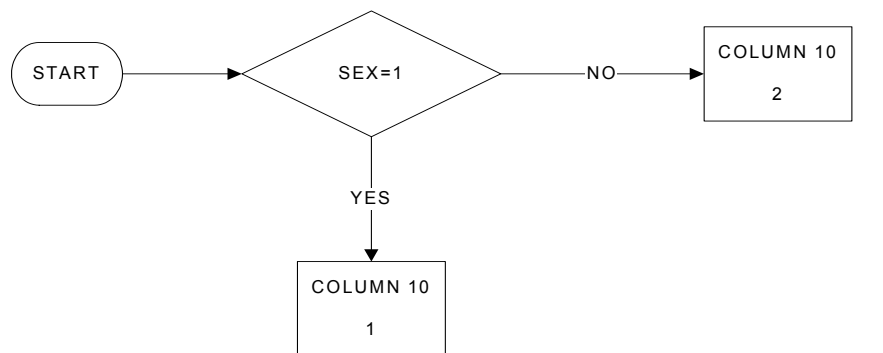

KEY	
1	Male
2	Female

YEARBIR (EYOB): Year of birth

Column 11/14

PAGE 1 OF 1

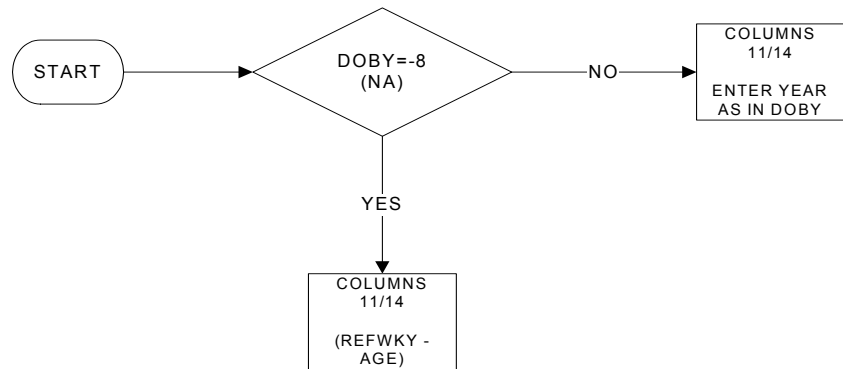

Notes:

The 4 digits of year of birth are entered

DATEBIR (EDOB): Date of birth in relation to end of reference week

Column 15

PAGE 1 OF 1

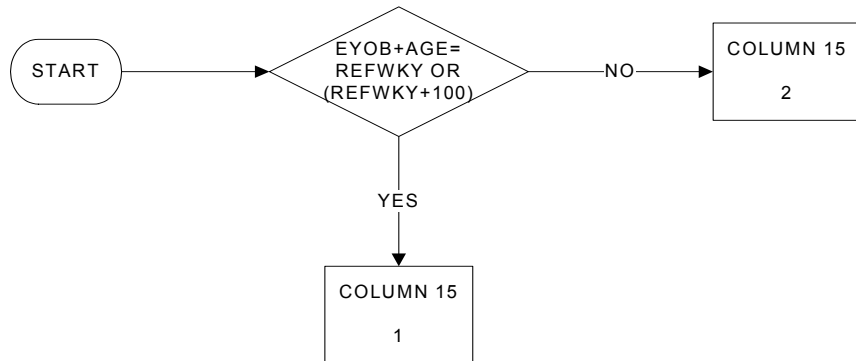

KEY

- 1 Person's birthday falls between 1 January and the end of the reference week.
- 2 Person's birthday falls after the end of the reference week.

Notes

Derive EYOB first

MARSTAT (EMARSTAT): Marital Status

Column 16

PAGE 1 OF 1

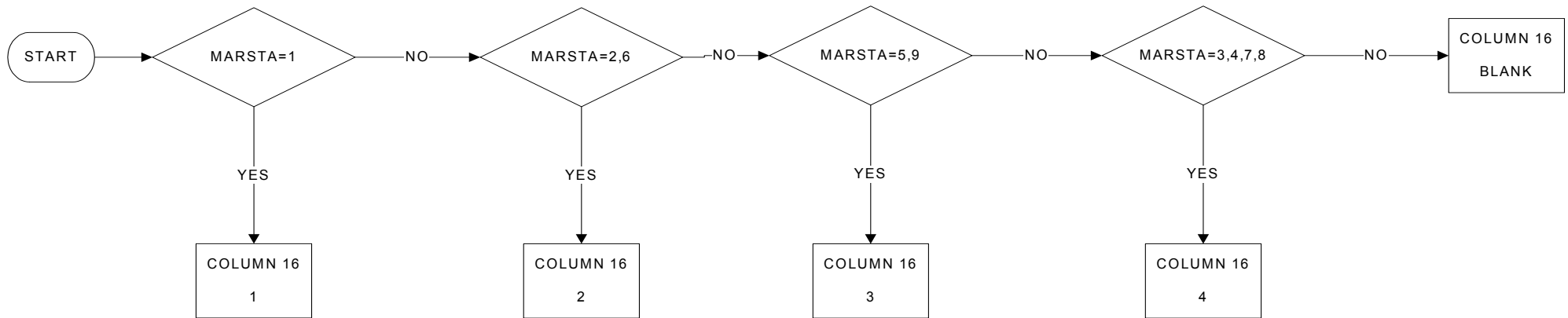

KEY	
1	Single
2	Married
3	Widowed
4	Divorced or legally separated
Blank	No answer

NATIONAL (ENAT): Nationality

Columns 17/18

PAGE 1 OF 7

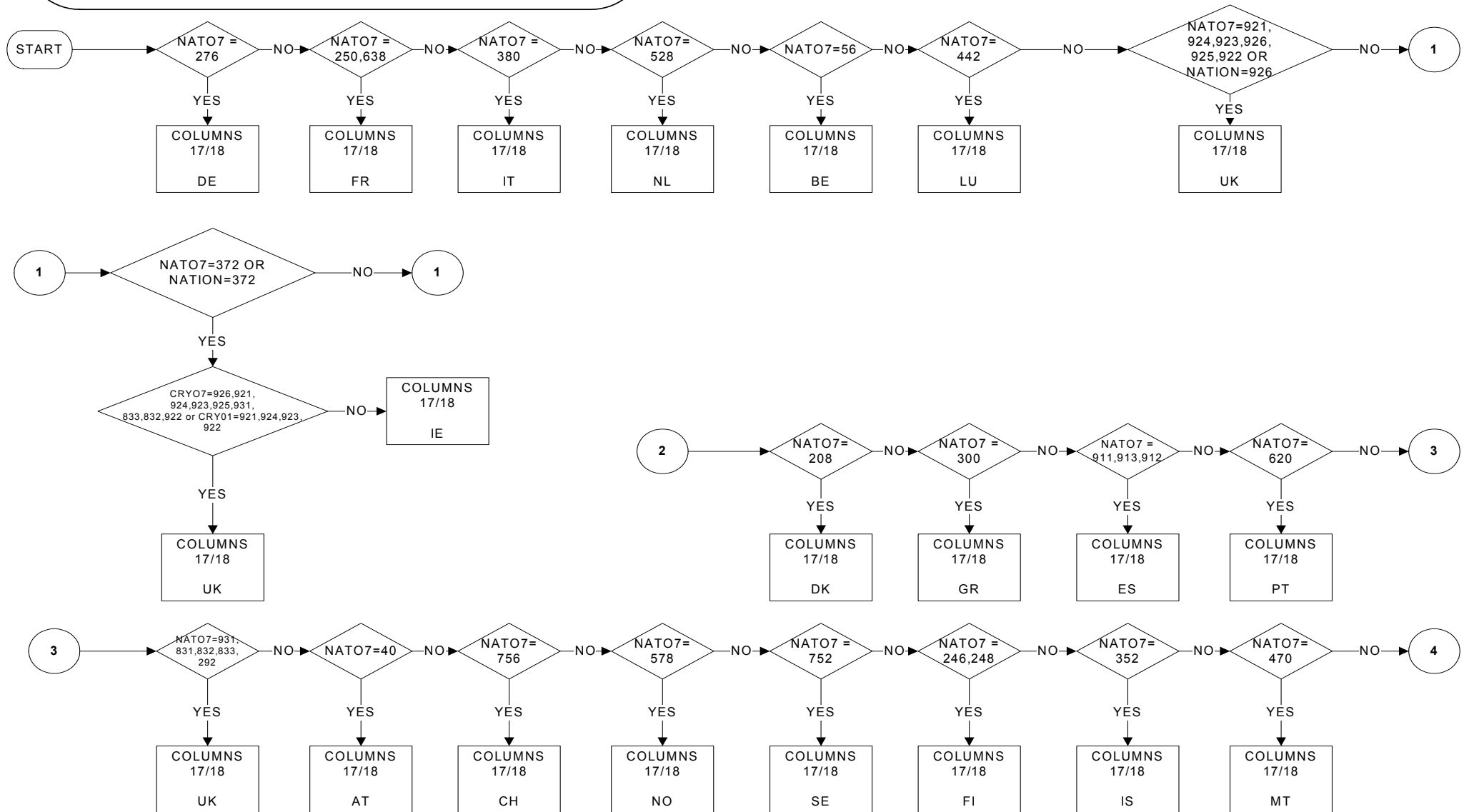

NATIONAL (ENAT): Nationality

Columns 17/18

PAGE 2 OF 7

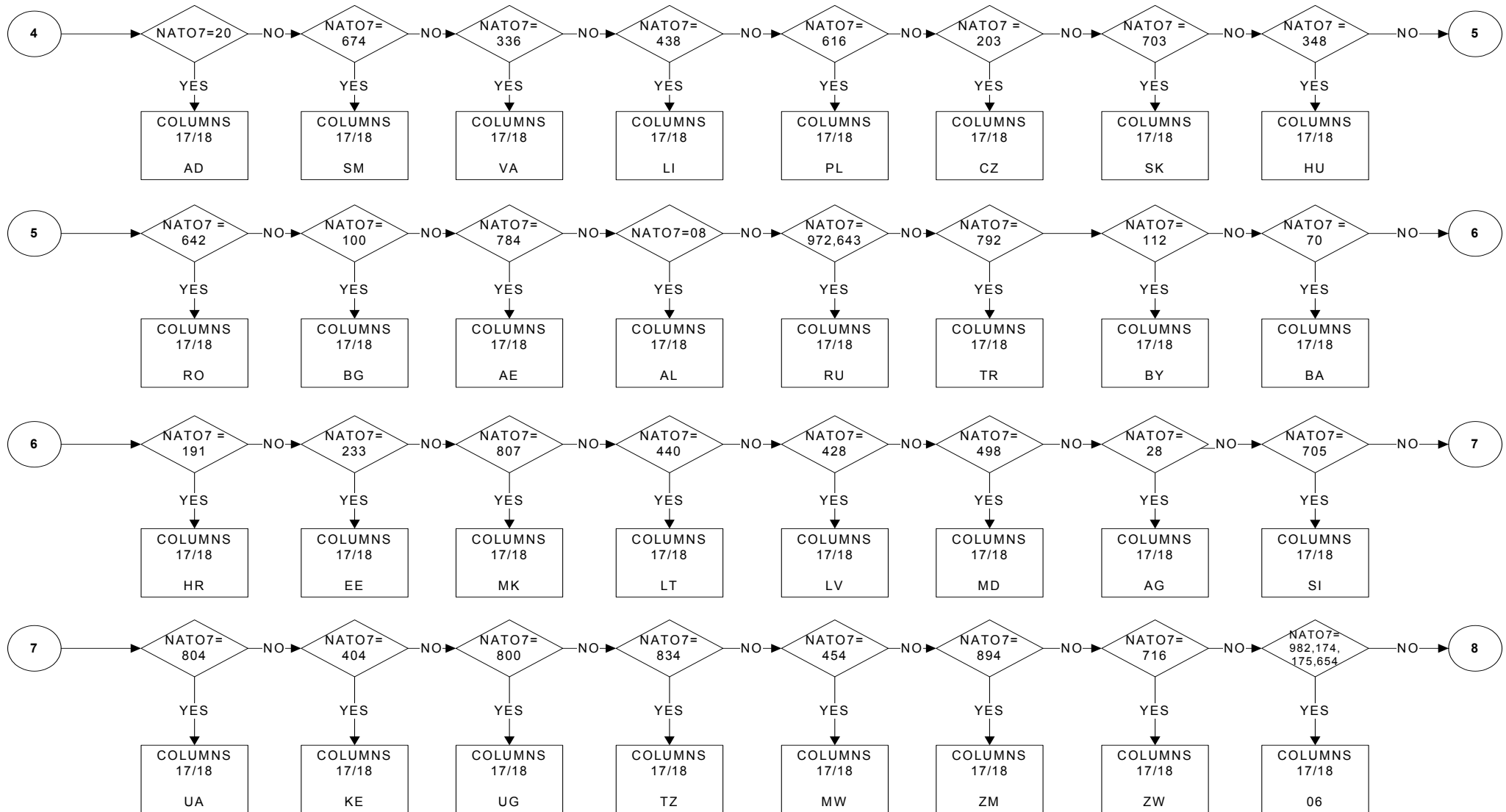

NATIONAL (ENAT): Nationality

Columns 17/18

PAGE 3 OF 7

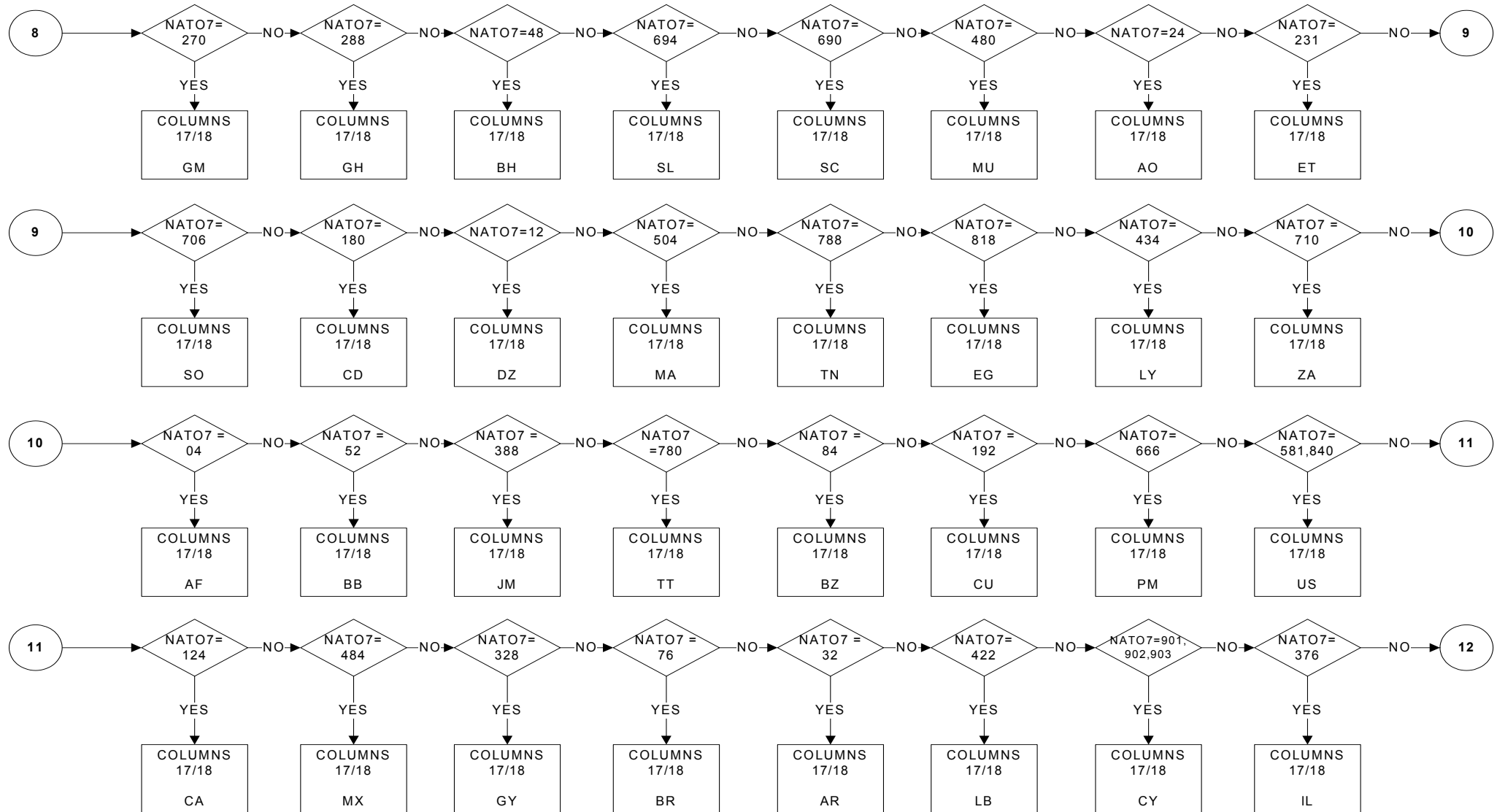

NATIONAL (ENAT): Nationality

Columns 17/18

PAGE 4 OF 7

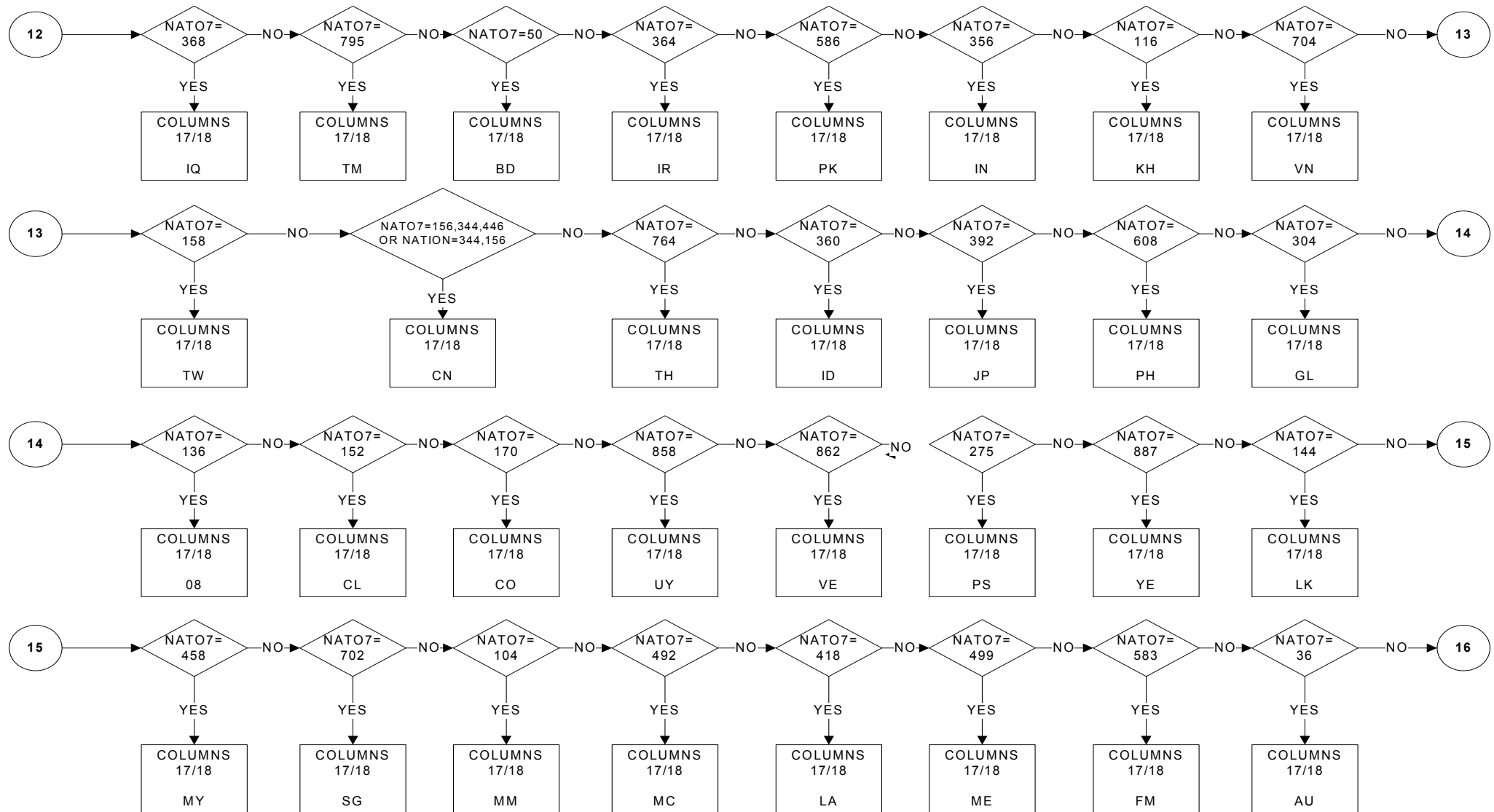

NATIONAL (ENAT): Nationality

Columns 17/18

PAGE 5 OF 7

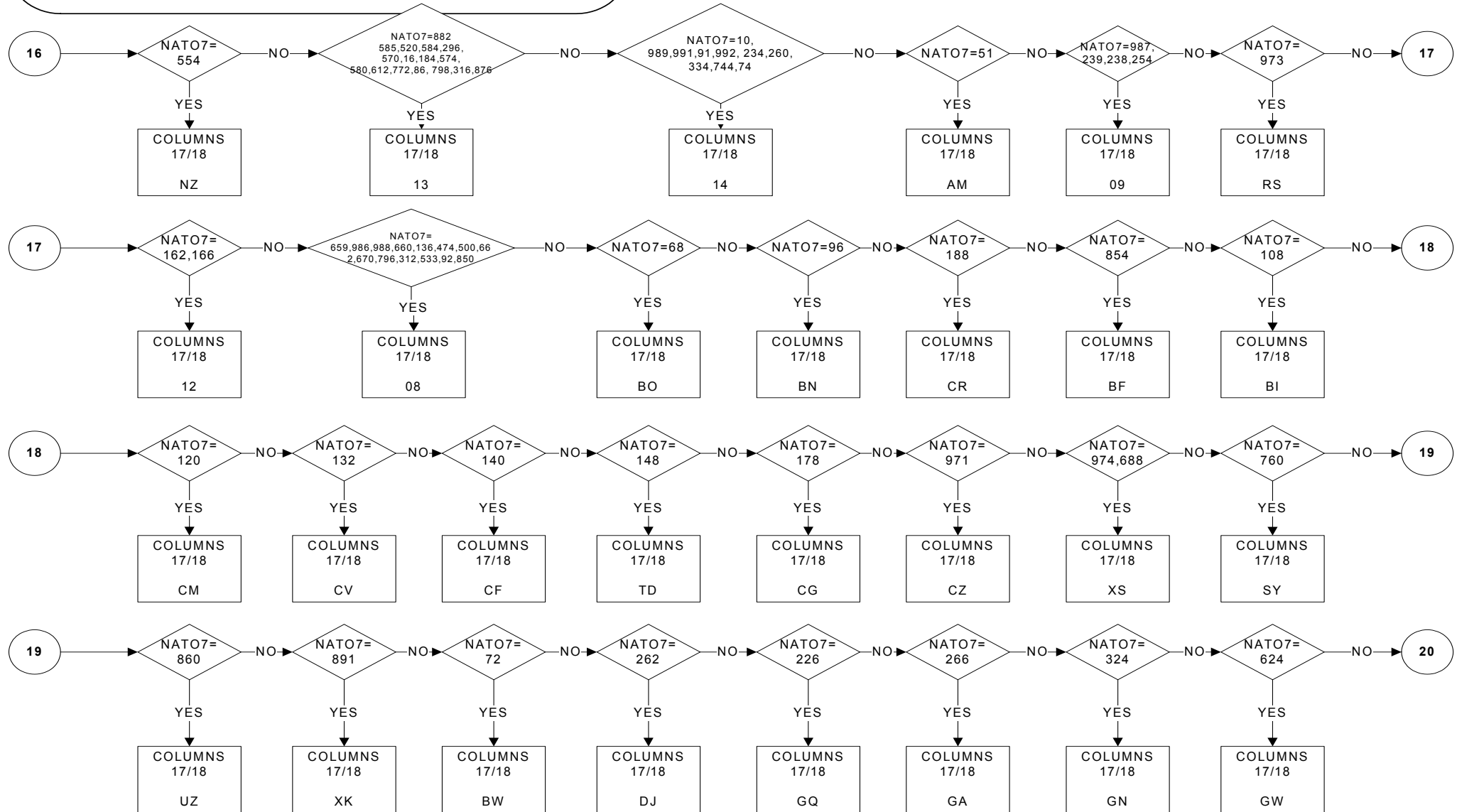

NATIONAL (ENAT): Nationality
Columns 17/18
 PAGE 6 OF 7

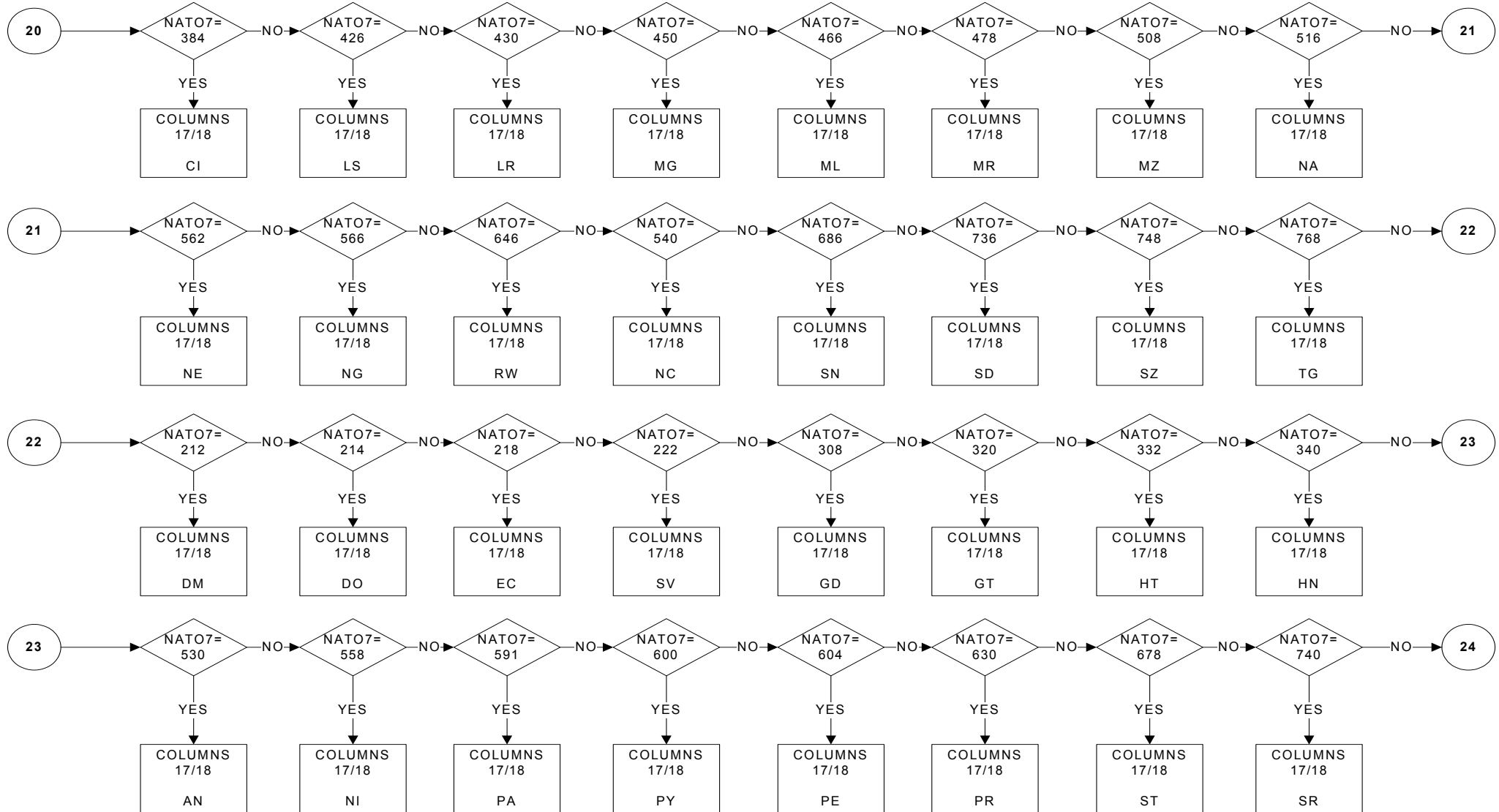

NATIONAL (ENAT): Nationality

Columns 17/18

PAGE 7 OF 7

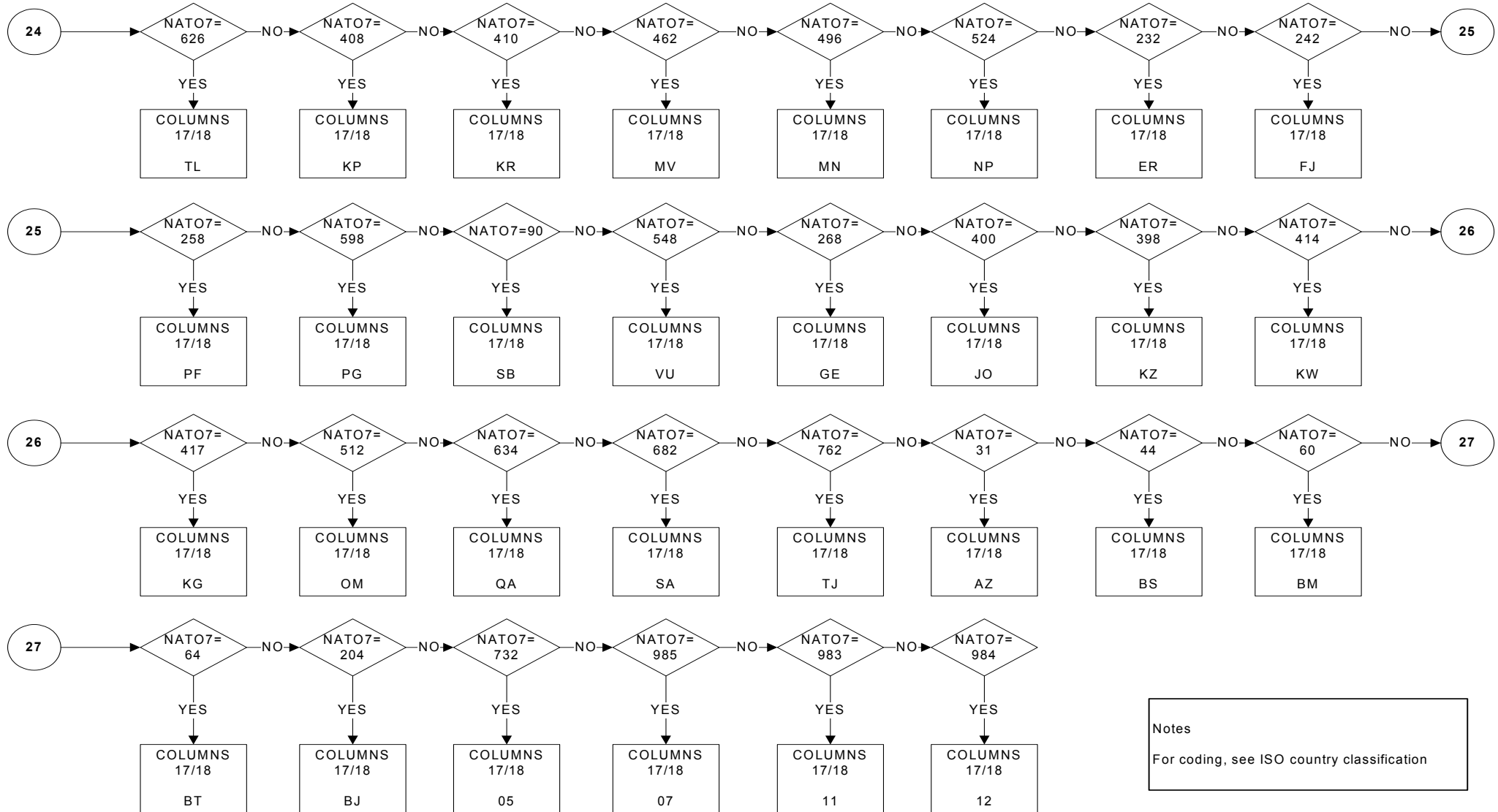

Notes
For coding, see ISO country classification

YEARESID (EYRSRES): Years of residence in this country

Column 19/20

PAGE 1 OF 2

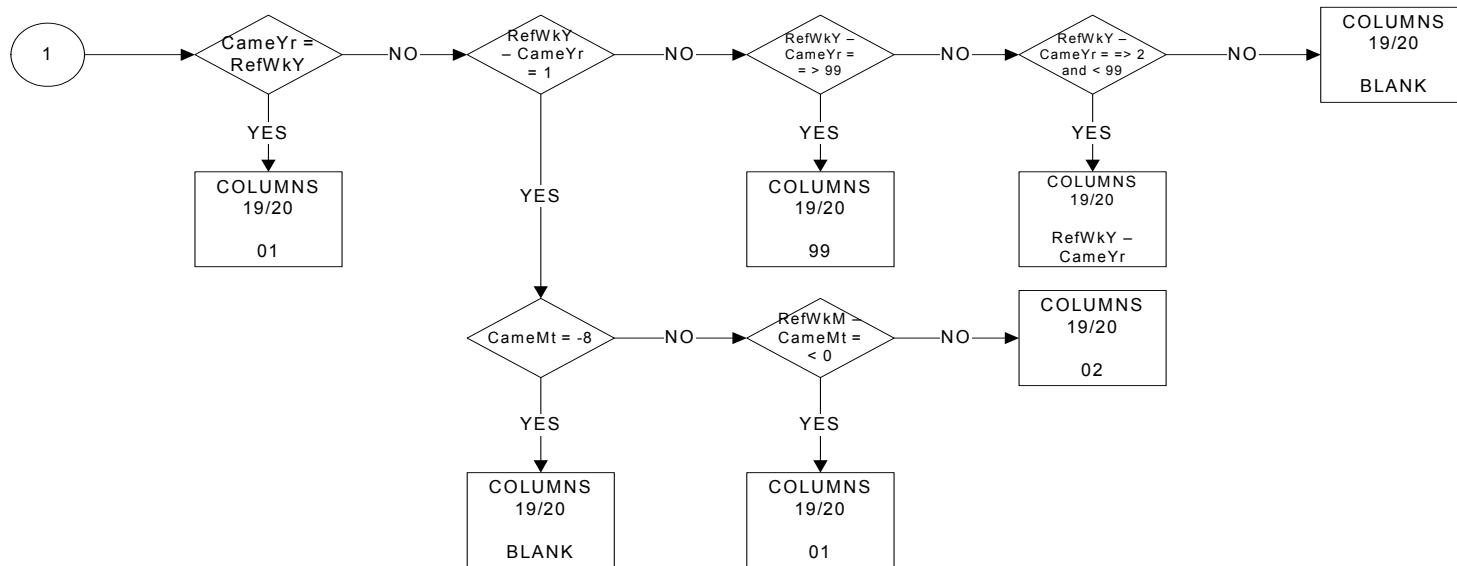
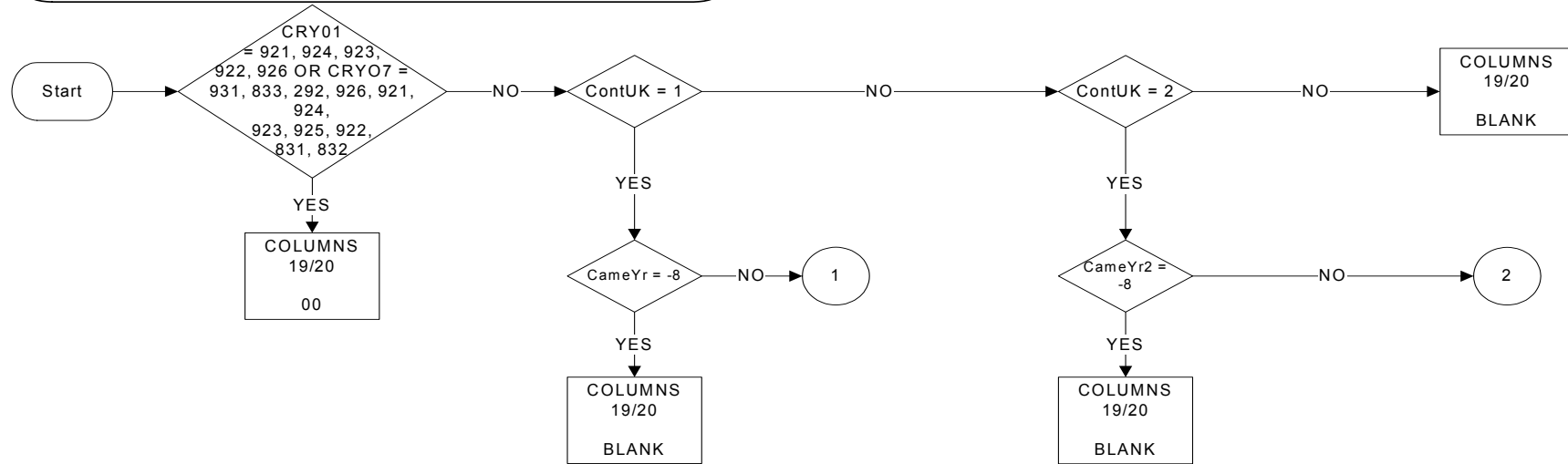

YEARESID (EYRSRES): Years of residence in this country

Column 19/20

PAGE 2 OF 2

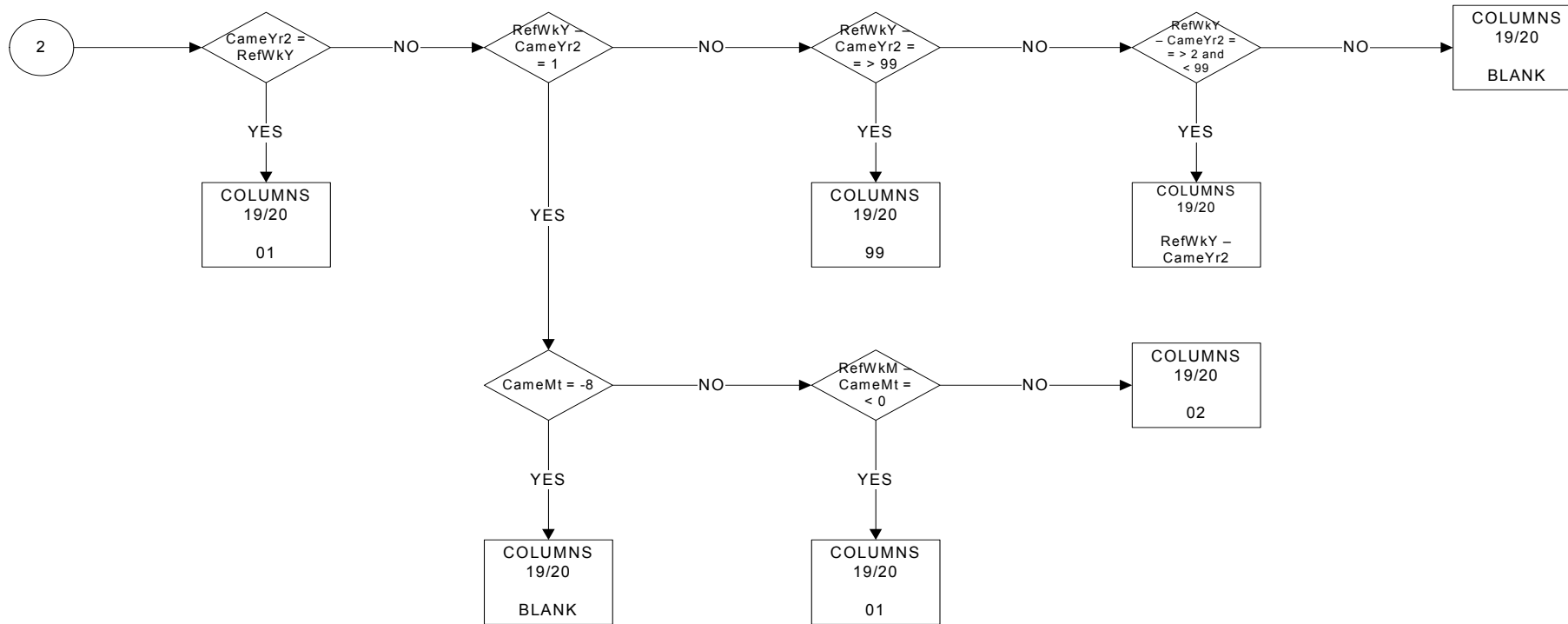

KEY

00 Born in this country
 01-99 Number of years of residence in this country
 BLANK No answer

Notes

Channel Island (7), Isle of Man (8) & Gibraltar (40) have been added to UK because they are not specified in 2006 codification

COUNTRYB (ECOB): Country of Birth

Columns 21/22

PAGE 1 OF 7

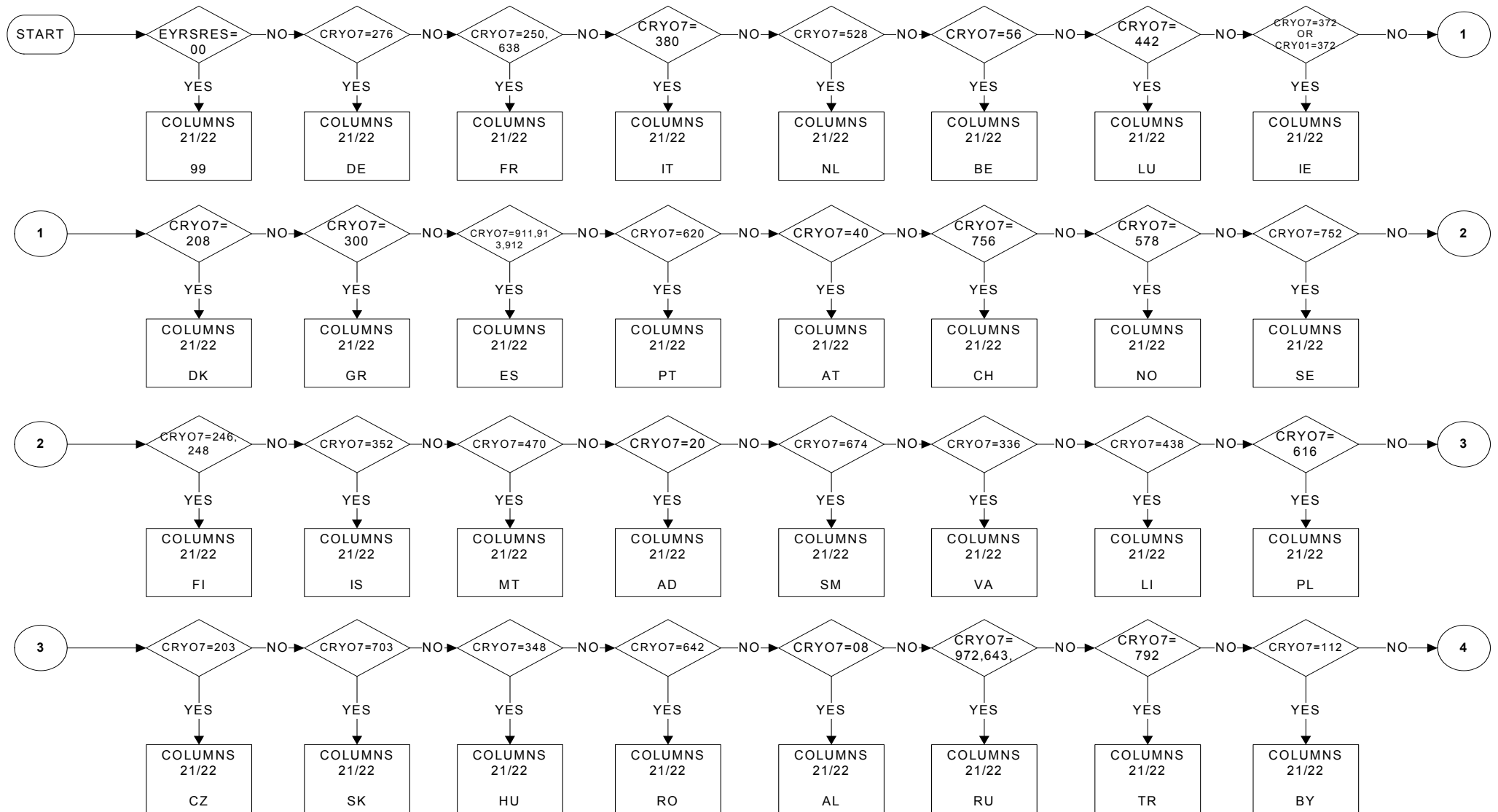

COUNTRYB (ECOB): Country of Birth

Columns 21/22

PAGE 2 OF 7

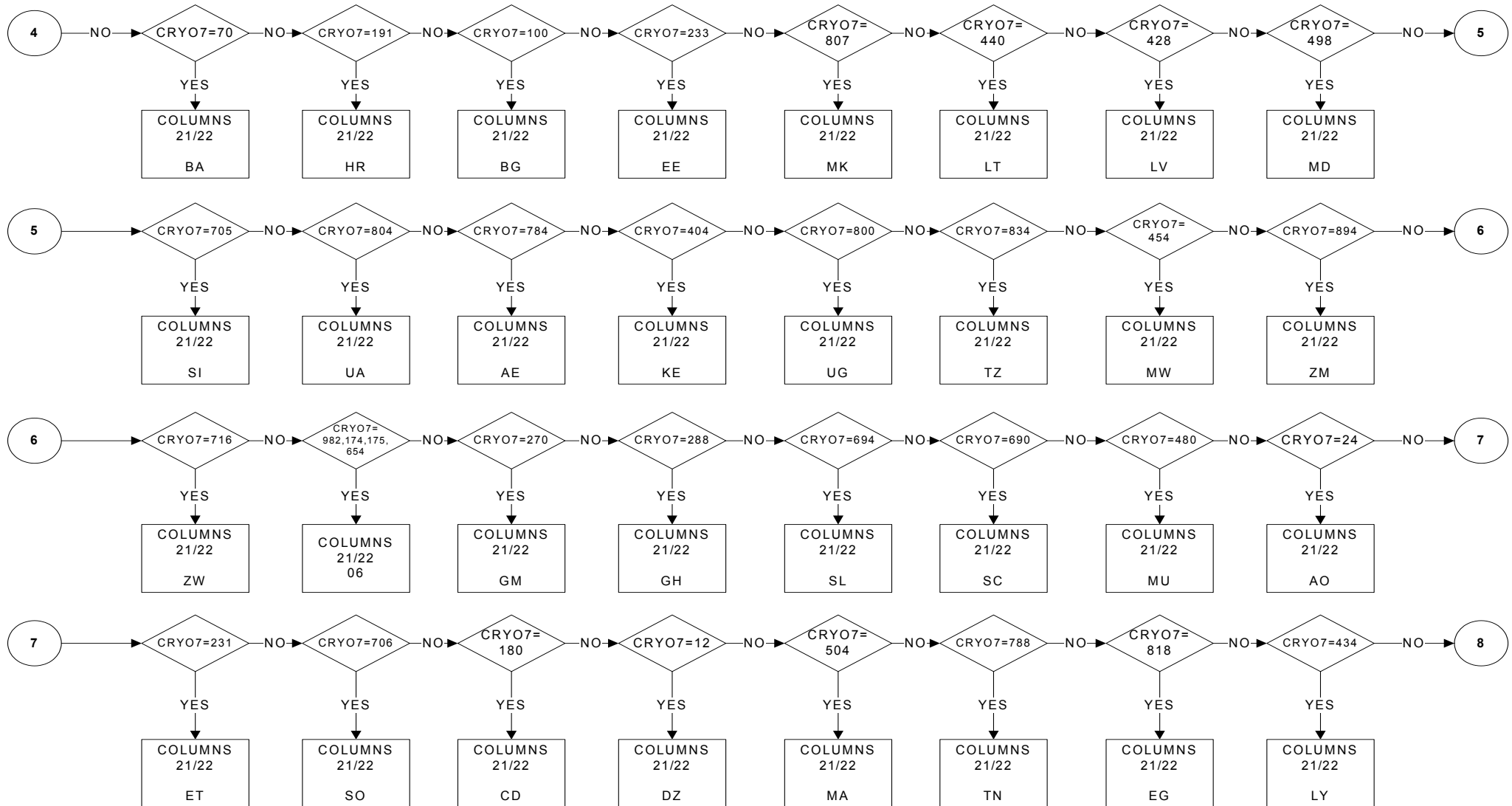

COUNTRYB (ECOB): Country of Birth

Columns 21/22

PAGE 3 OF 7

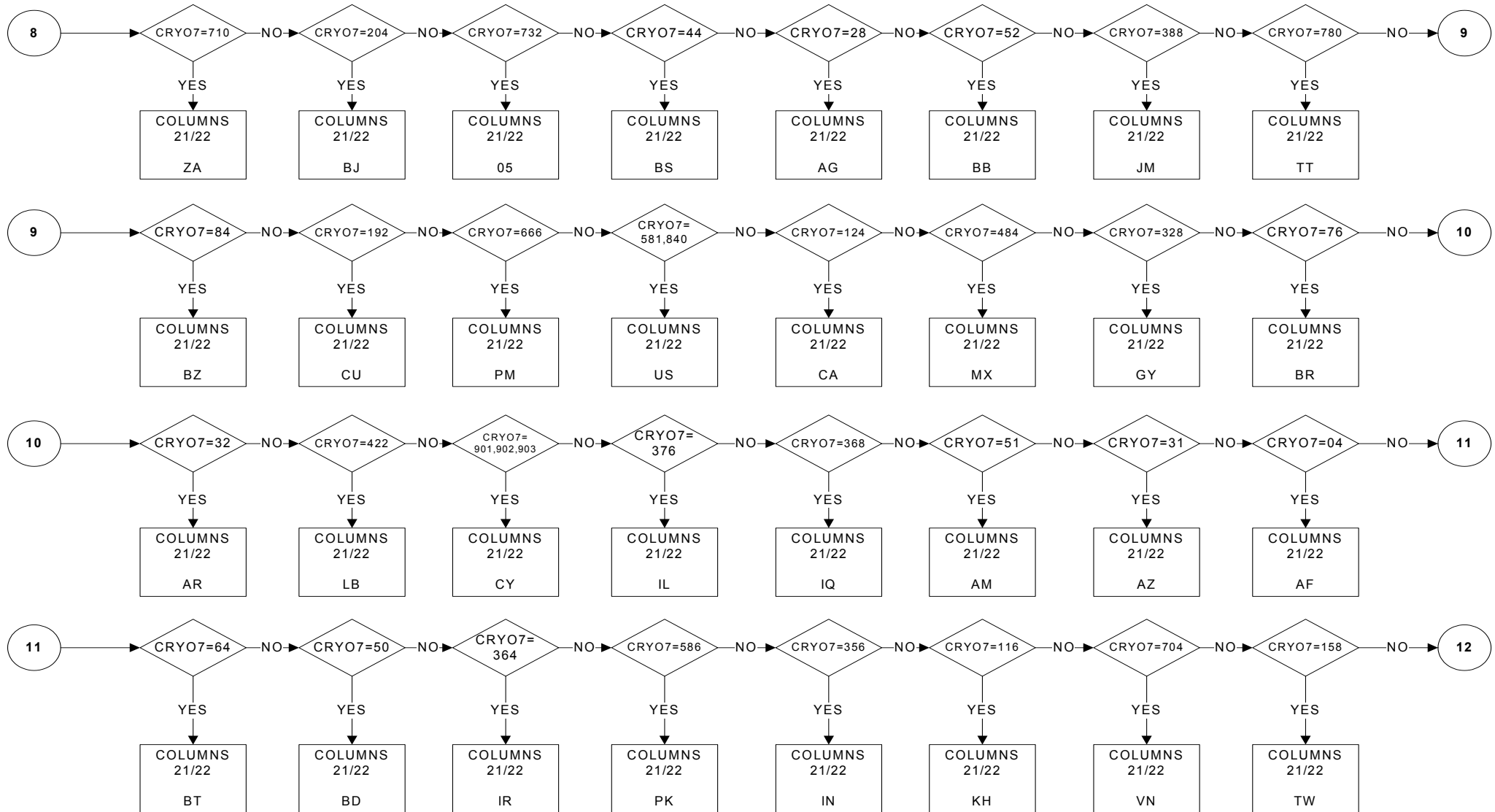

COUNTRYB (ECOB): Country of Birth

Columns 21/22

PAGE 4 OF 7

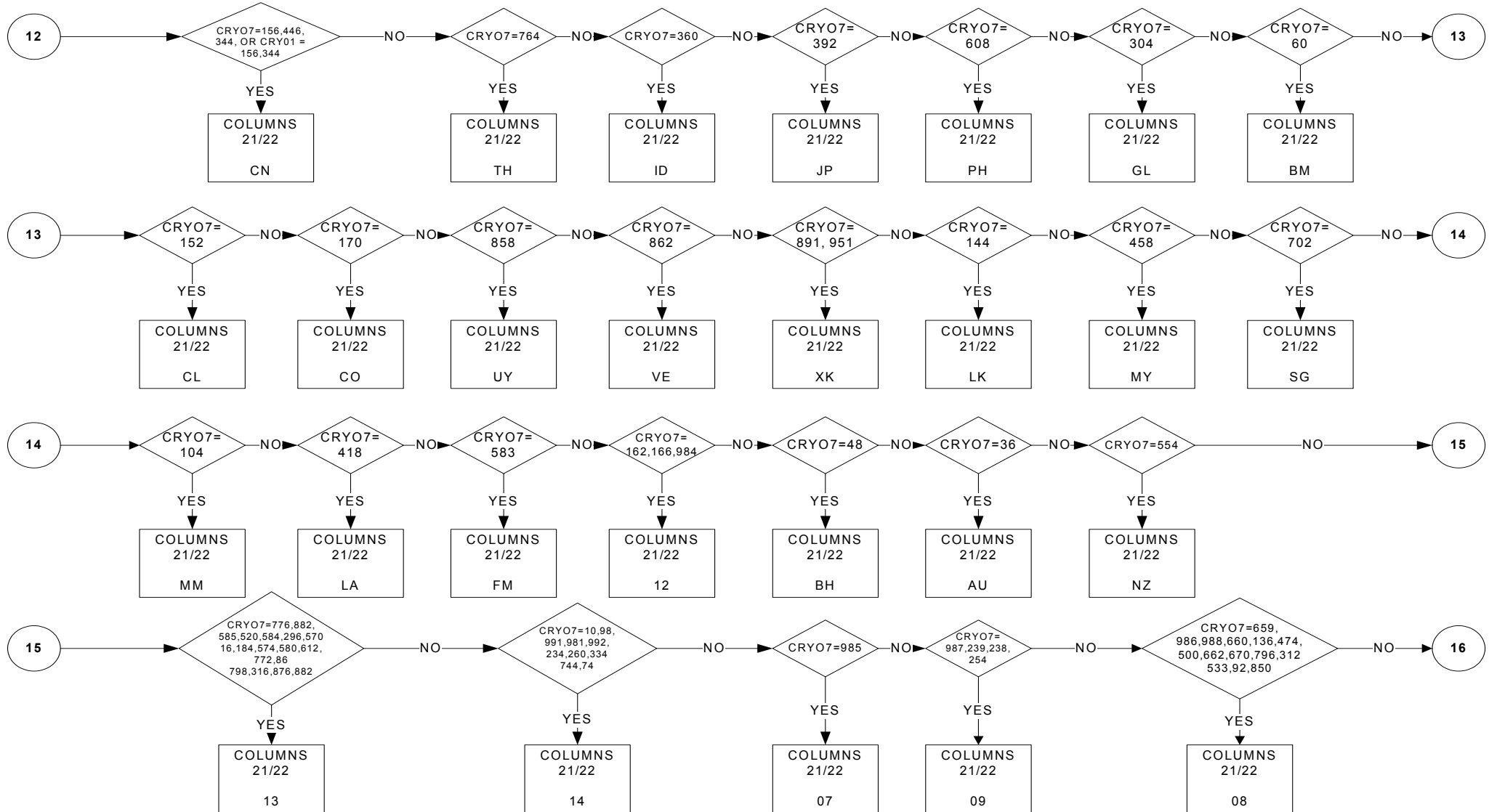

COUNTRYB (ECOB): Country of Birth

Columns 21/22

PAGE 5 OF 7

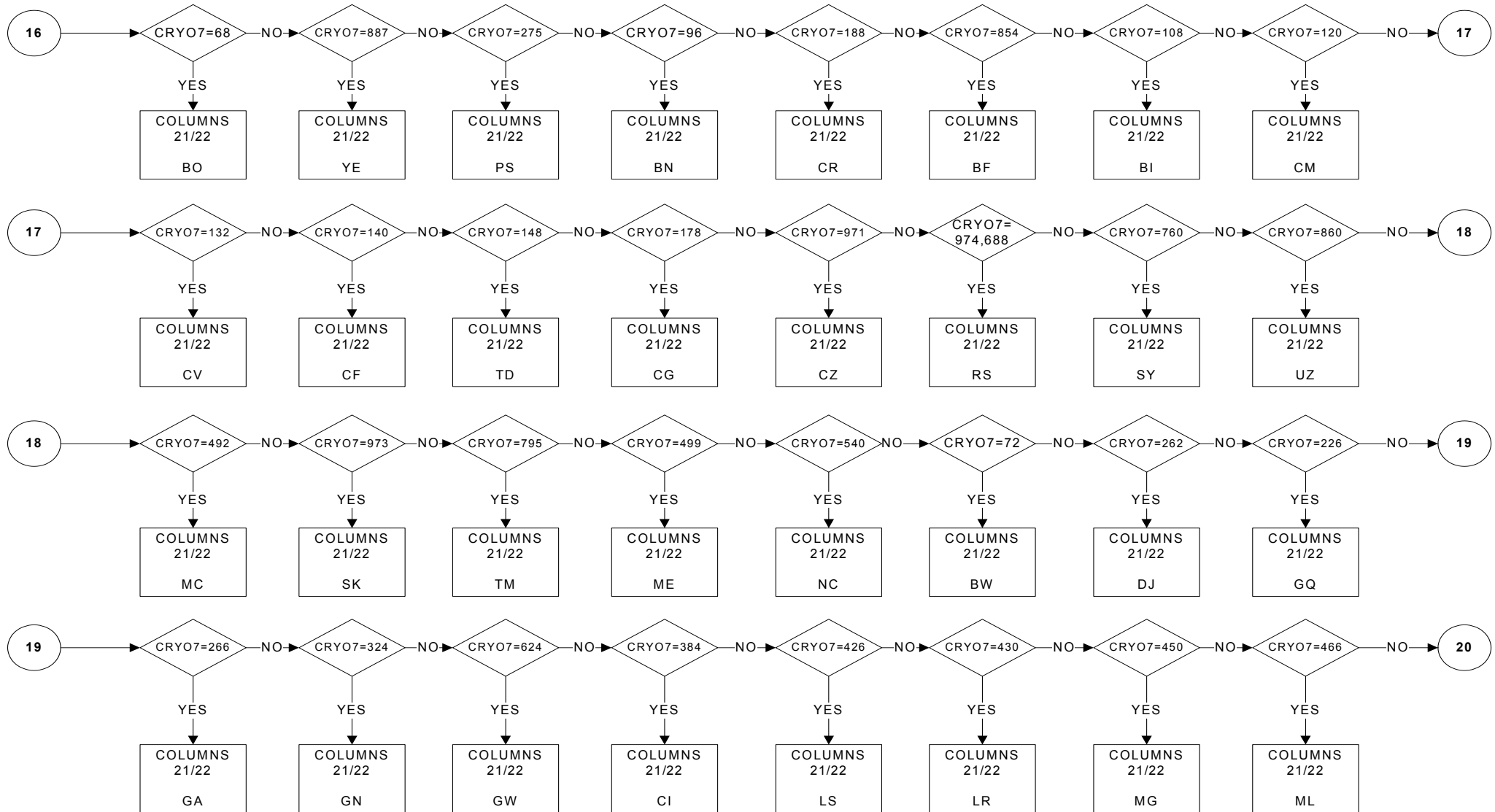

COUNTRYB (ECOB): Country of Birth

Columns 21/22

PAGE 6 OF 7

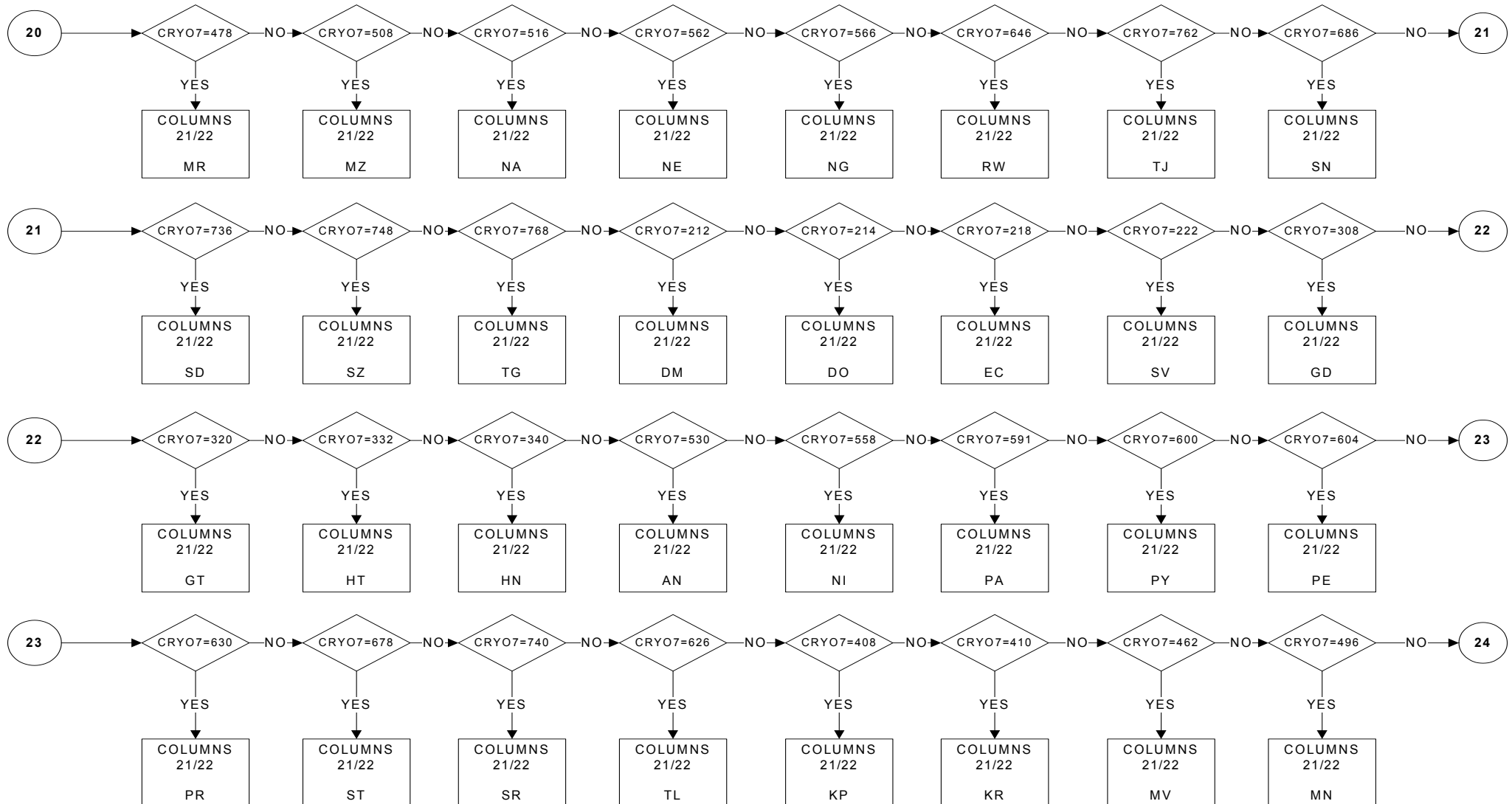

COUNTRYB (ECOB): Country of Birth

Columns 21/22

PAGE 7 OF 7

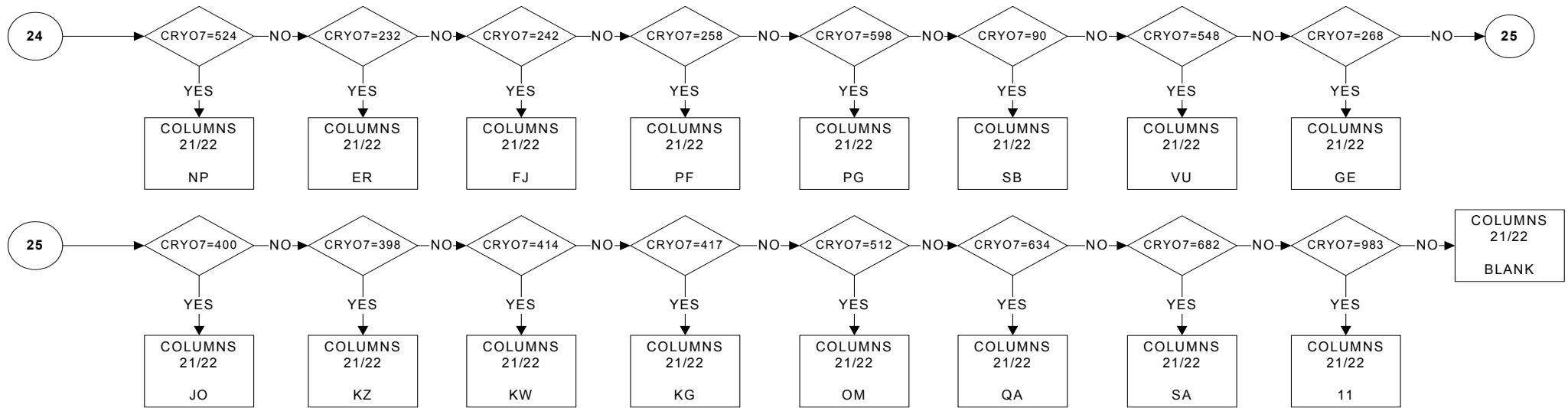

KEY
 99 Not Applicable (Col 19/20 = 00)
 BLANK No Answer
Notes
 For coding, see ISO country classification

PROXY (EPROXY): Nature of participation in survey

Column 23
PAGE 1 OF 1

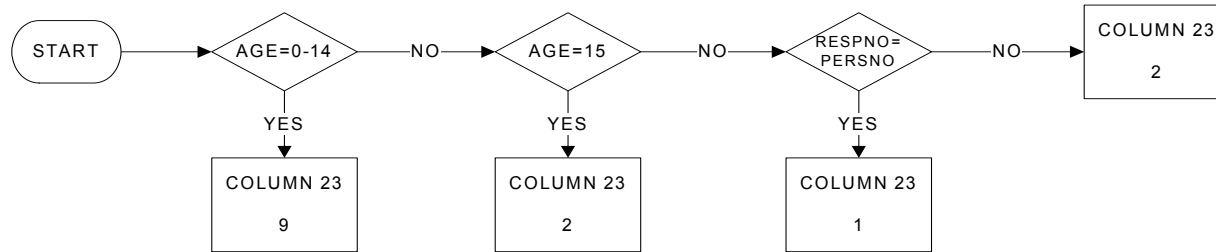

KEY	
1	Direct participation
2	Participation via another member of the household
9	Not applicable (child less than 15 years old)
BLANK	No answer

WSTATOR (EWKSTATR): Labour status during the reference week
 Column 24
 PAGE 1 OF 2

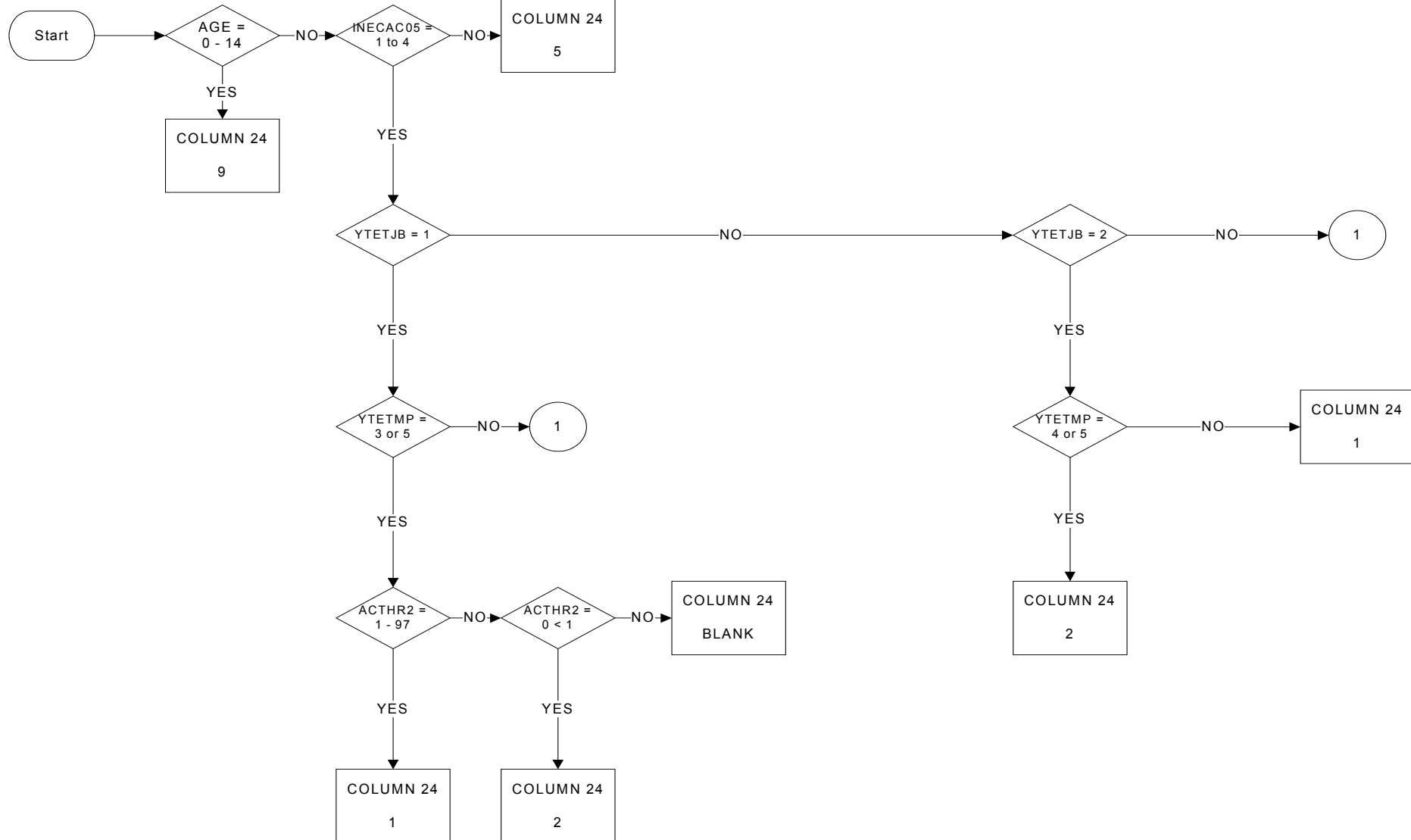

WSTATOR (EWKSTATR): Labour status during the reference week

Column 24

PAGE 2 OF 2

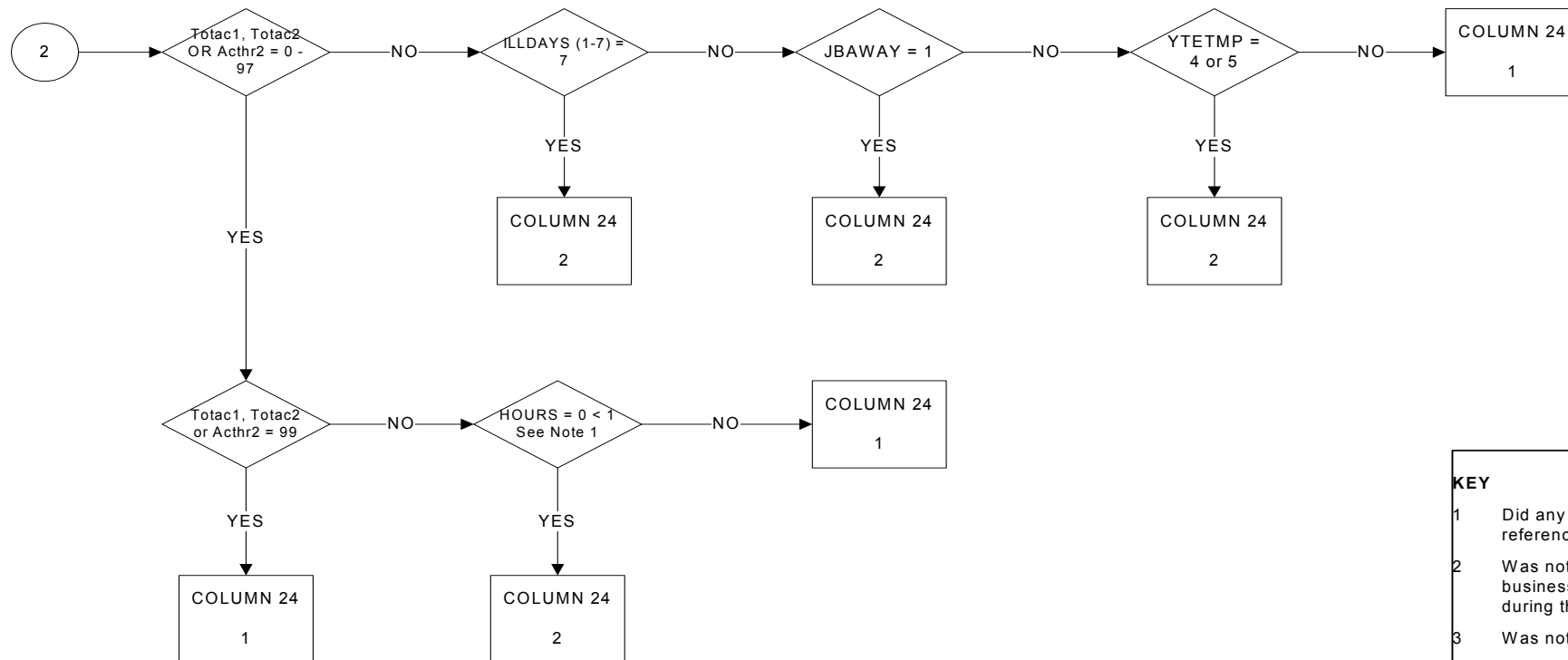

KEY

- 1 Did any work for pay or profit during the reference week - one hour or more
- 2 Was not working but had a job or business from which he/she was absent during the reference week
- 3 Was not working because on lay-off
- 4 Was a conscript on compulsory military or community service
- 5 Other (15 years or more) who neither worked nor had a job or business during the reference week
- 9 Not applicable (child less than 15 years old)

Note 1:

(TOTAC1 (if TOTAC1 >=0 and <= 97) +
TOTAC2 (if TOTAC2 >=0 and <= 97) +
ACTHR2 (if ACTHR2 >=0 and <= 97) =

0 to less than 1

NOWKREAS (ERESAWYR): Reason for not having worked at all though having a job

Column 25/26

PAGE 1 OF 2

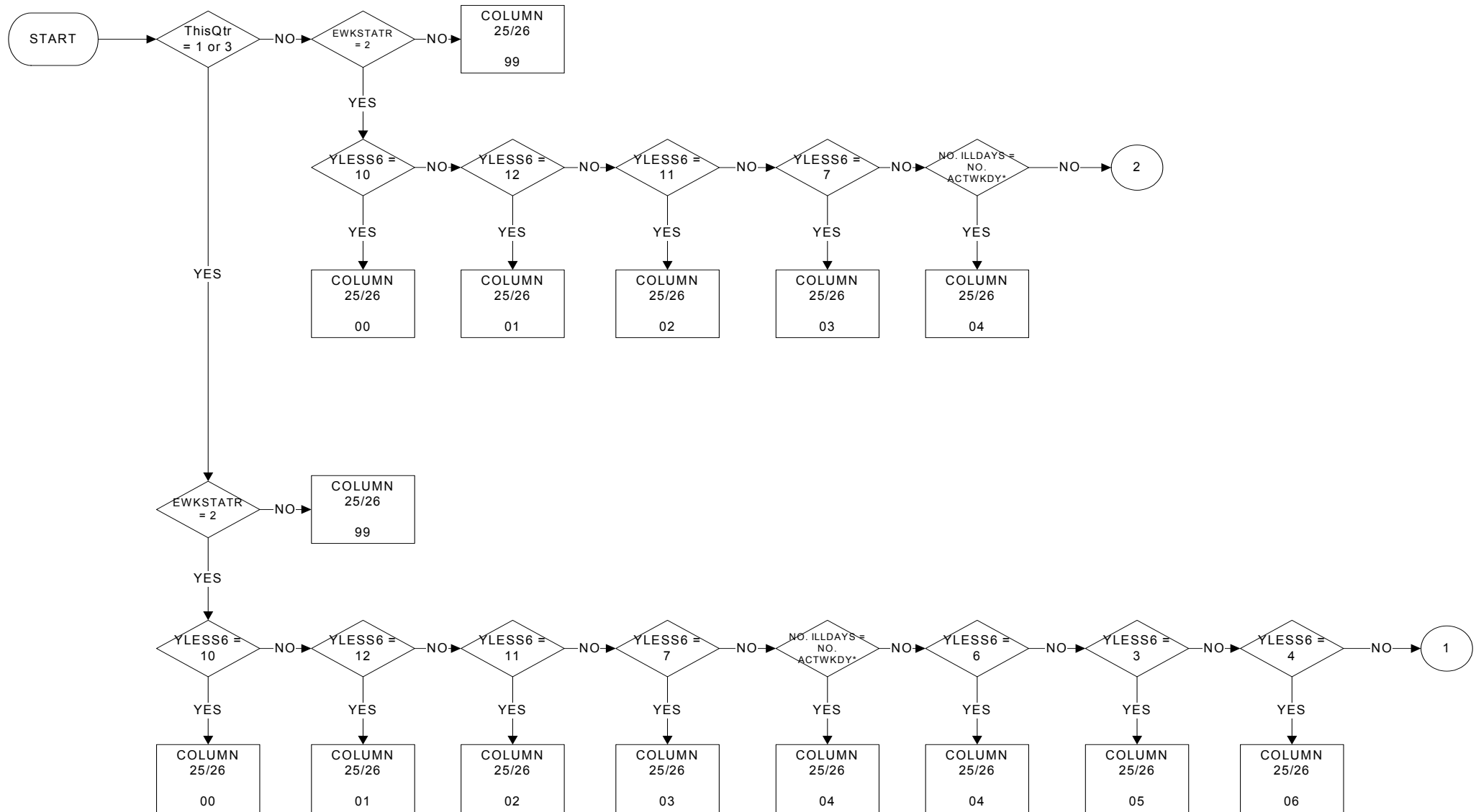

NOWKREAS (ERESAWYR): Reason for not having worked at all though having a job

Column 25/26

PAGE 2 OF 2

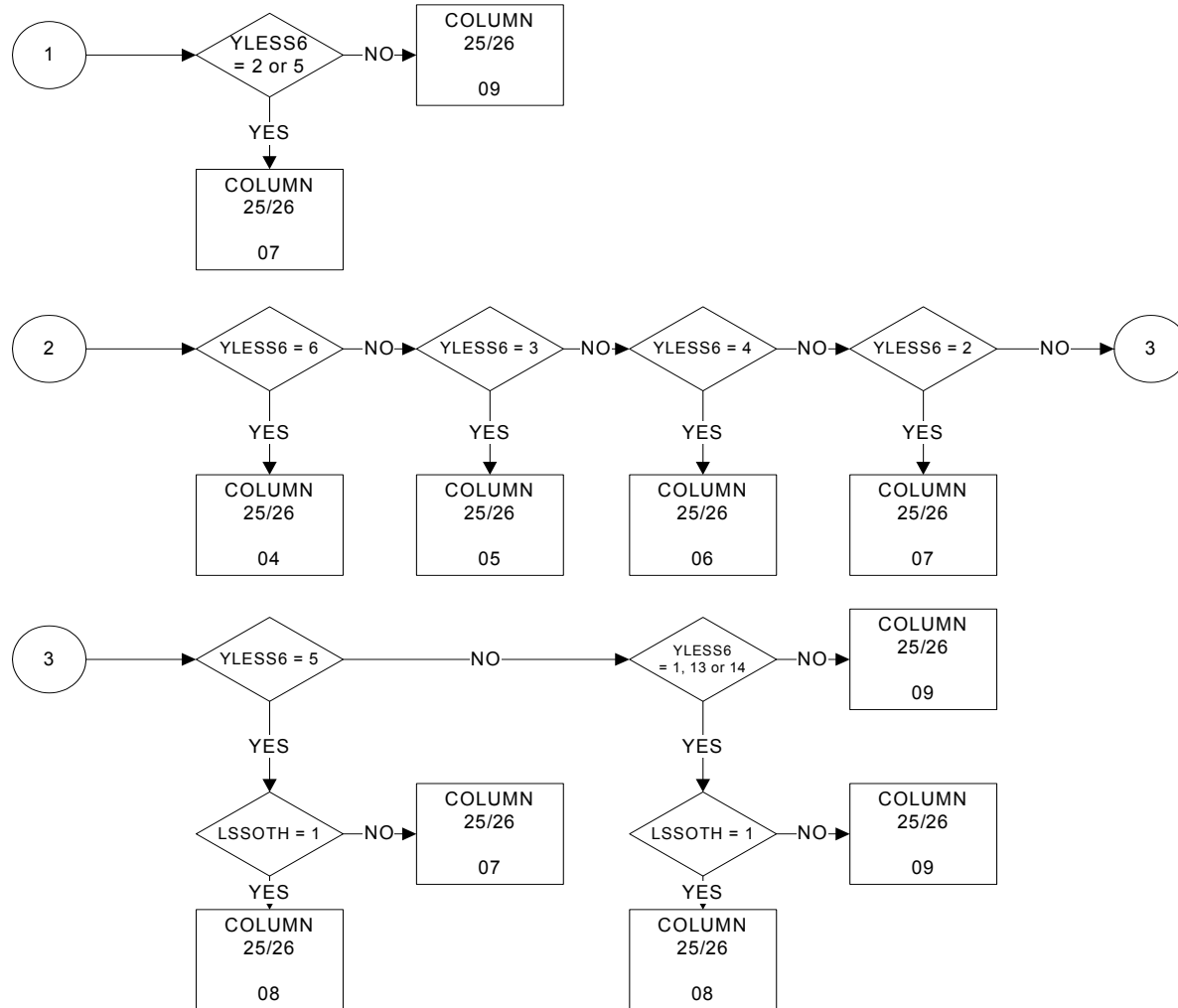

KEY

- 00 Bad weather
- 01 Slack work for technical or economic reasons
- 02 Labour dispute
- 03 School education or training
- 04 Own illness, injury or temporary disability
- 05 Maternity leave
- 06 Parental leave
- 07 Holidays
- 08 Compensation leave (within the framework of working time banking or an annualised hours contract)
- 09 Other reasons (e.g. personal or family responsibilities)
- 99 Not applicable (WSTATOR = 1, 3-5, 9)

Notes

LSSOTH asked in AJ and OD quarters only

* No. of positive replies in ILLDAYS(1-7) and ACTWKDY(1-7), and illdays > 0

STAPRO (ESTATR): Professional status

Column 27
PAGE 1 OF 1

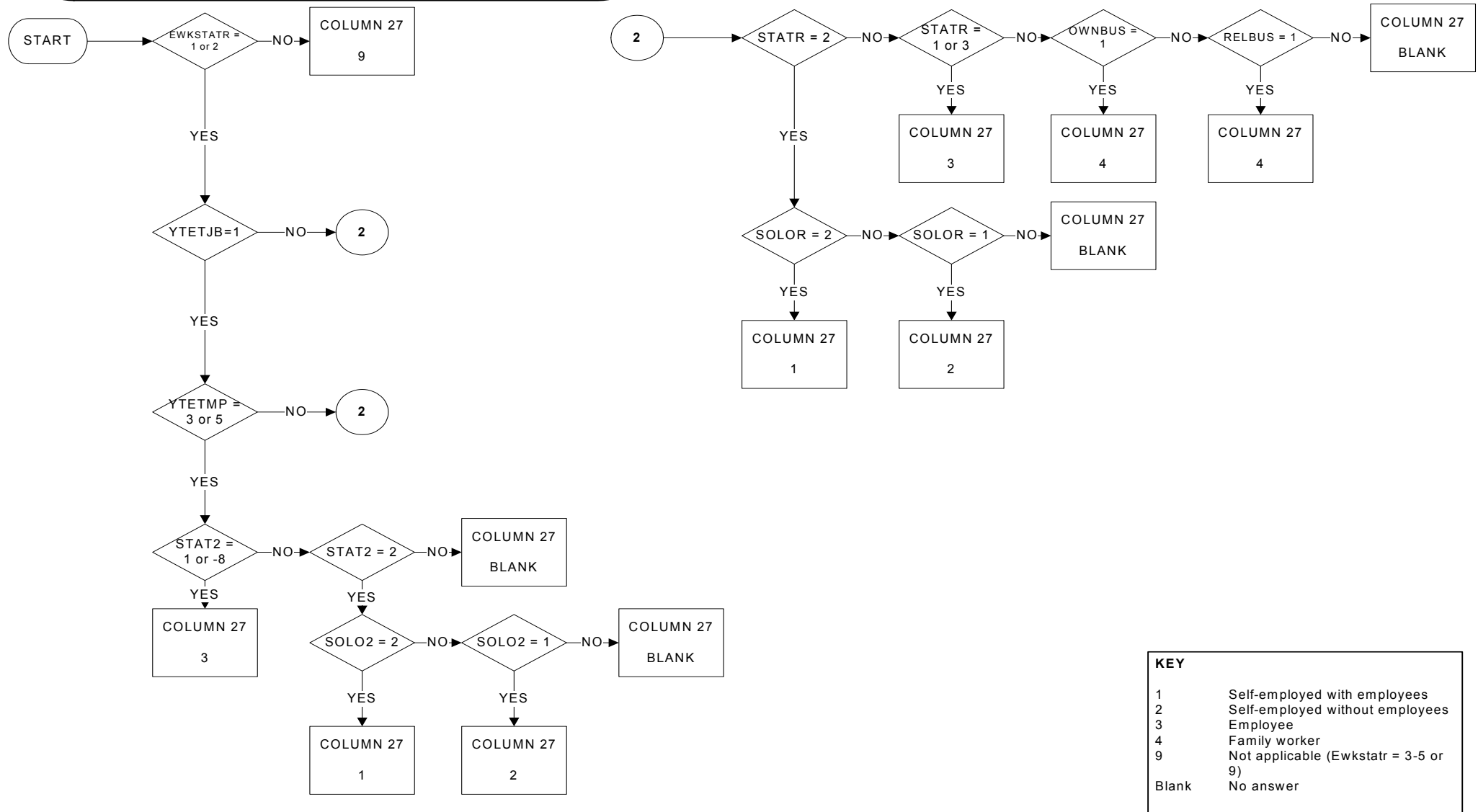

KEY	
1	Self-employed with employees
2	Self-employed without employees
3	Employee
4	Family worker
9	Not applicable (Ewkstatr = 3-5 or 9)
Blank	No answer

SIGNISAL (EFISAL): Continuing receipt of wage or salary

Column 28
PAGE 1 OF 1

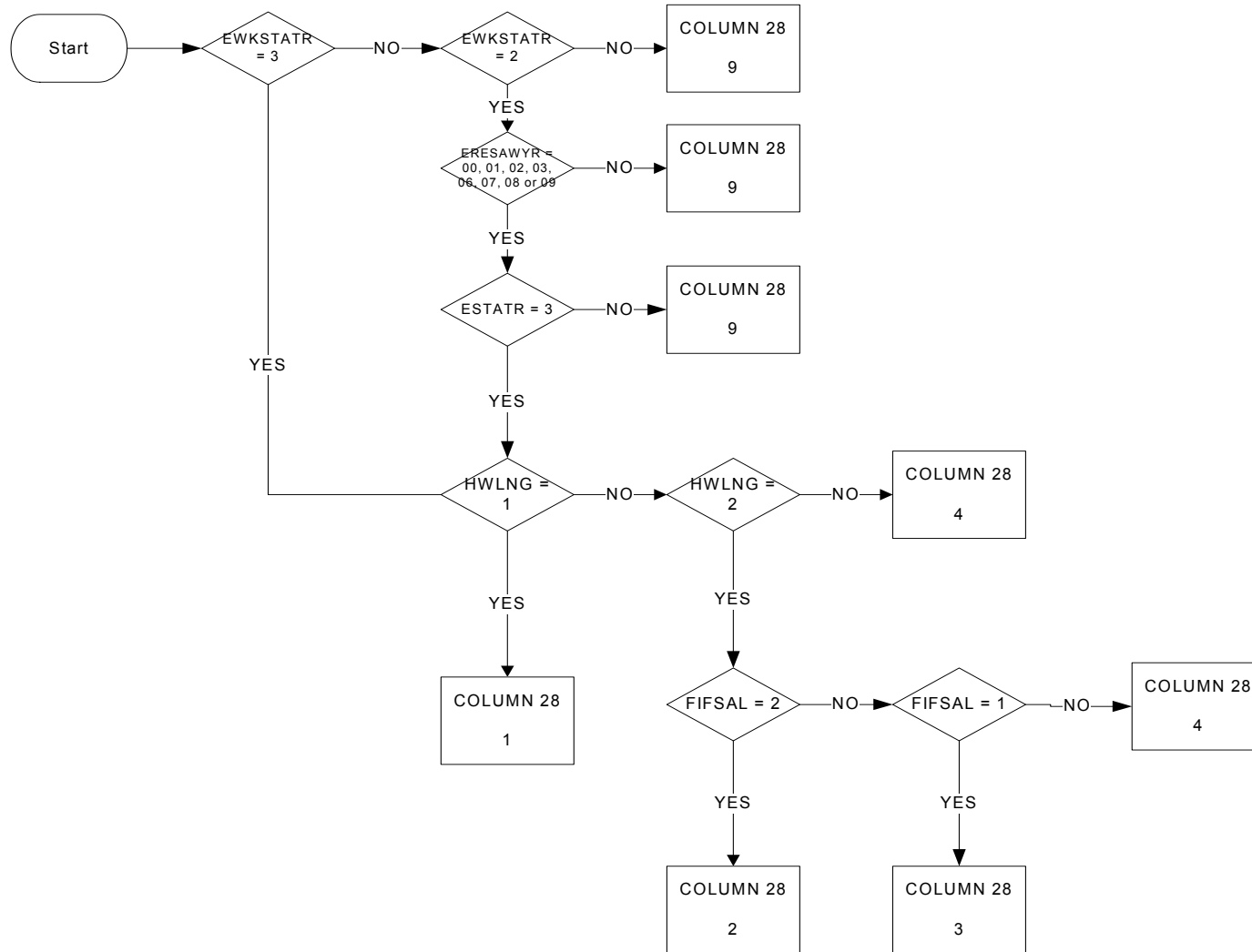

KEY

- 1 Absent for up to and including 3 months
- 2 Absent for more than 3 months and receiving a wage, salary or social allowances corresponding to half or more of the salary
- 3 Absent for more than 3 months and receiving a wage, salary or social allowances corresponding to less than half of the salary
- 4 Don't know
- 9 Not applicable ((WSTATOR ? 2 or NOWKREAS = 04 or NOWKREAS = 05 or STAPRO ? 3) and WSTATOR ? 3)

NACE3D (ENACE08): Economic activity of the local unit

Column 29/31

PAGE 1 OF 1

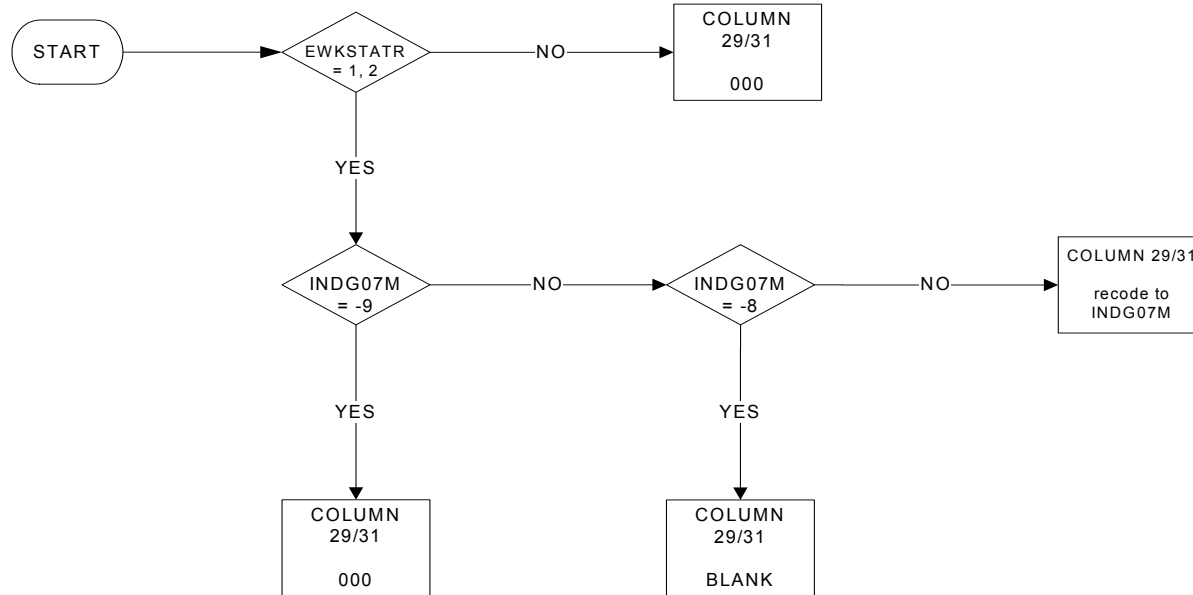

KEY

NACE Rev. 2 coded at 2 or if possible 3 digit level

000 Not applicable (WSTATOR = 3-5, 9)

Blank No answer

ISCO4D (EISCOMR): Occupation

Columns 32/35

PAGE 1 OF 3

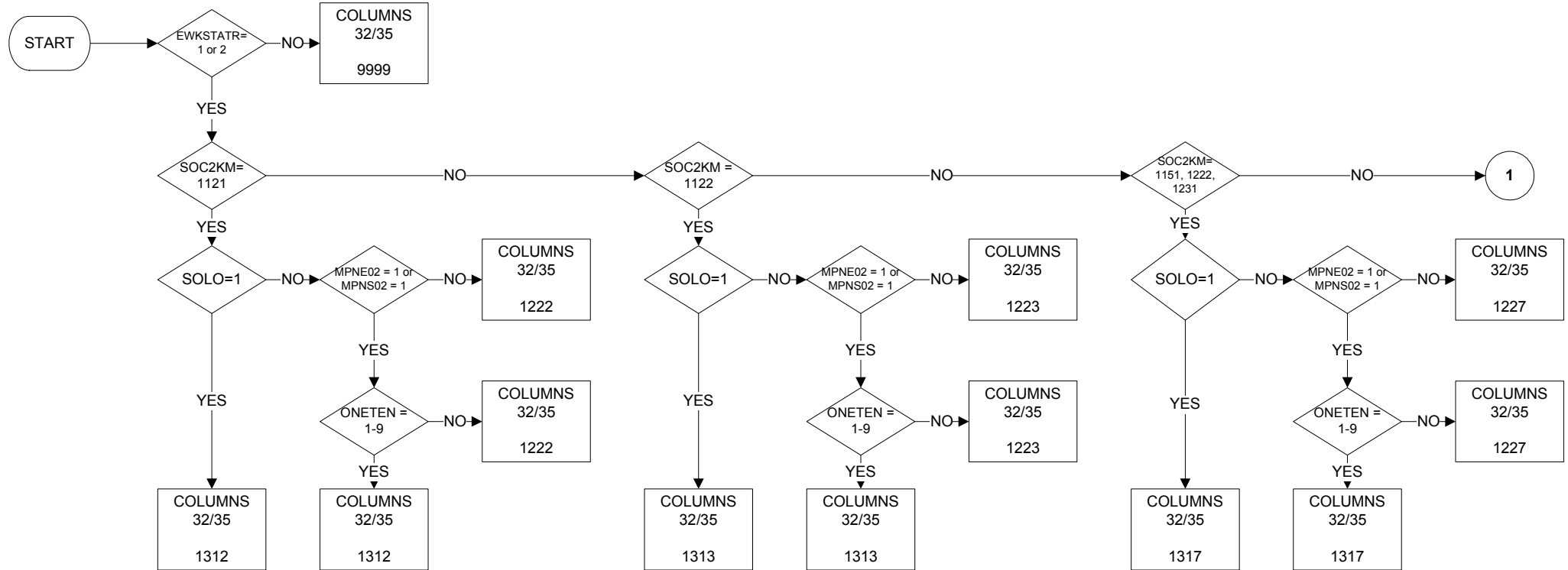

ISCO4D (EISCOMR): Occupation

Columns 32/35

PAGE 2 OF 3

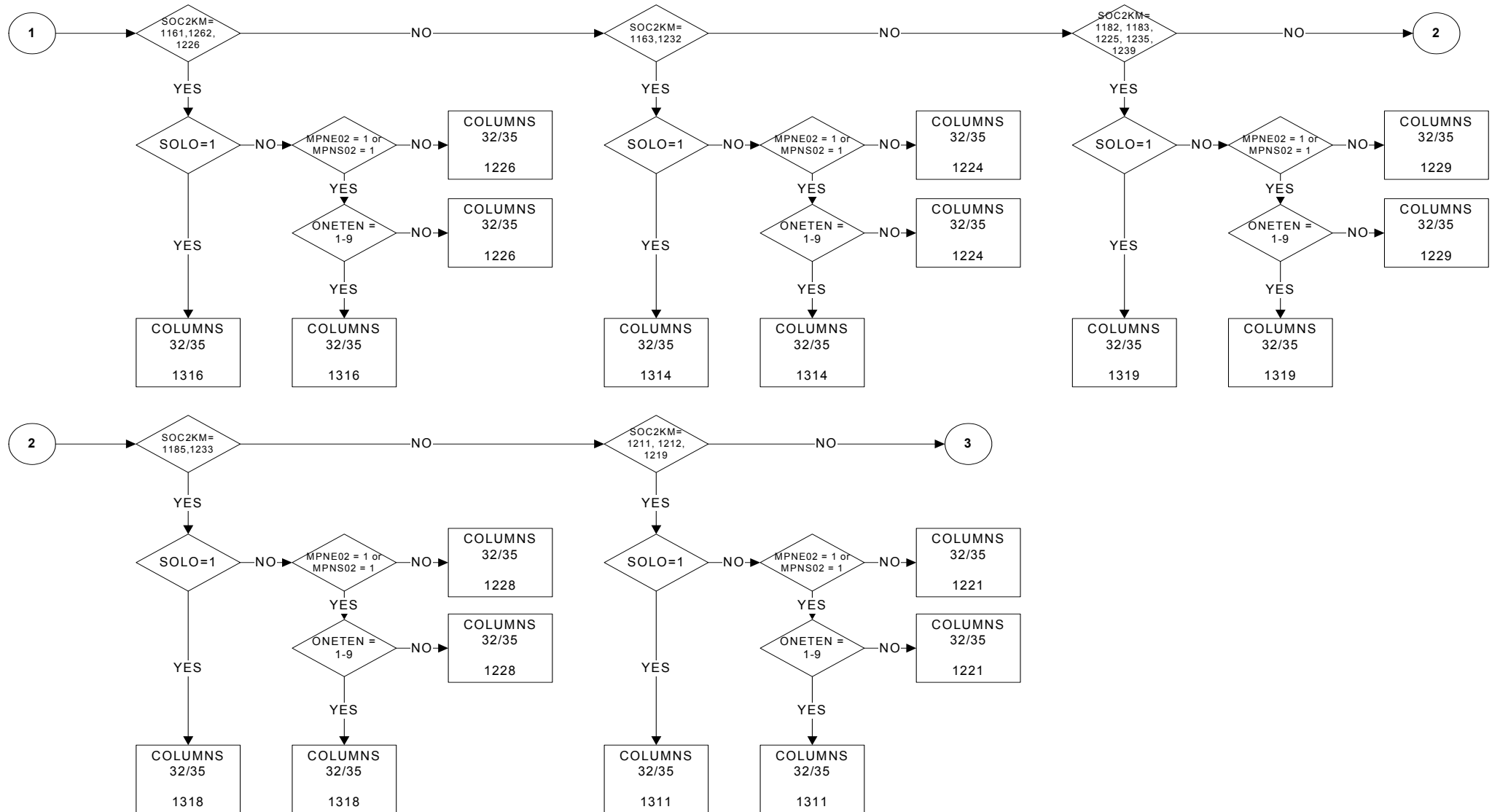

ISCO4D (EISCOMR): Occupation

Columns 32/35

PAGE 3 OF 3

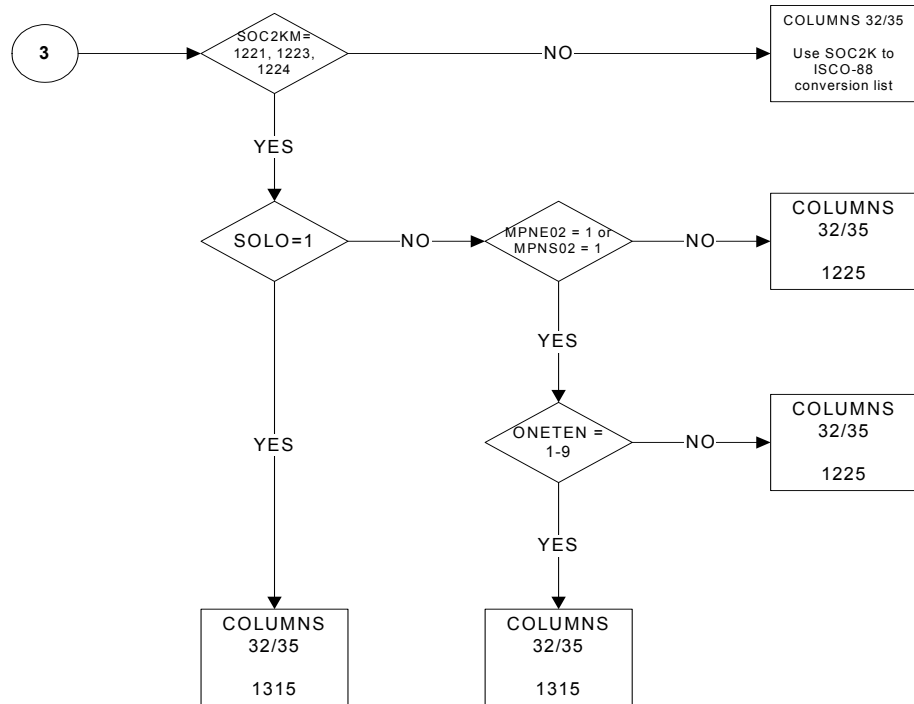

KEY

9999 Not applicable (WSTATOR = 3-5,9)

blank No answer

Notes

ISCO-88 (COM) coded at 3 or if possible 4 digit level

The questionnaire variables SOLO and MPNE/MPNS can be used as EWKSTATR filters for current job only.

SUPVISOR (ESUPVIS): Supervisory responsibilities

Column 36

PAGE 1 OF 1

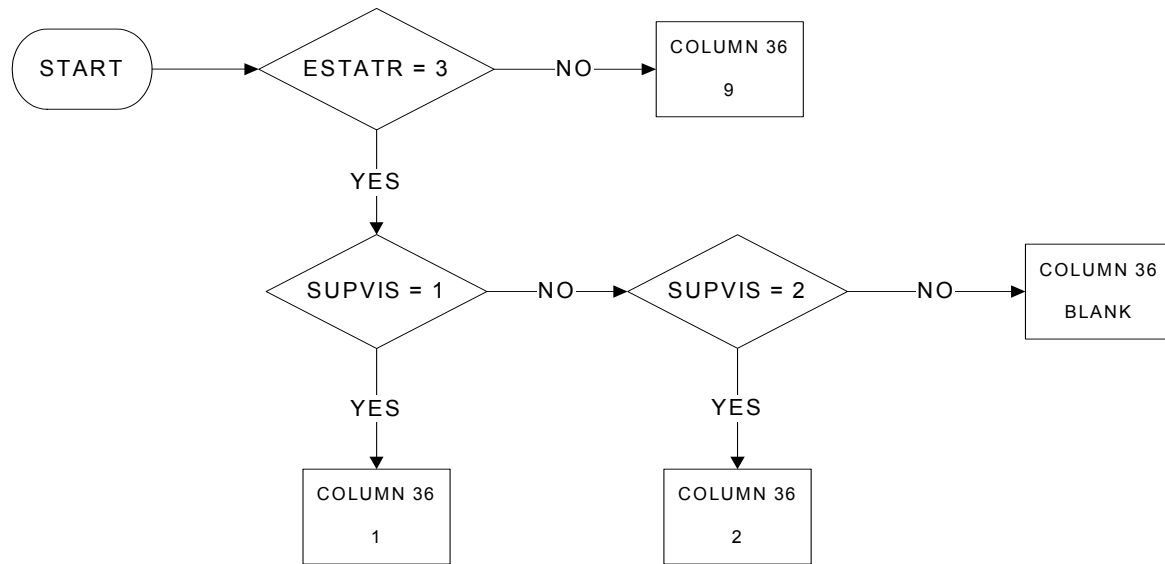

KEY	
1	Yes
2	No
9	STAPRO is not equal to 3
blank	No answer

SIZEFIRM (ENUMPR): Number of persons working at the local unit

Columns 37/38

PAGE 1 OF 1

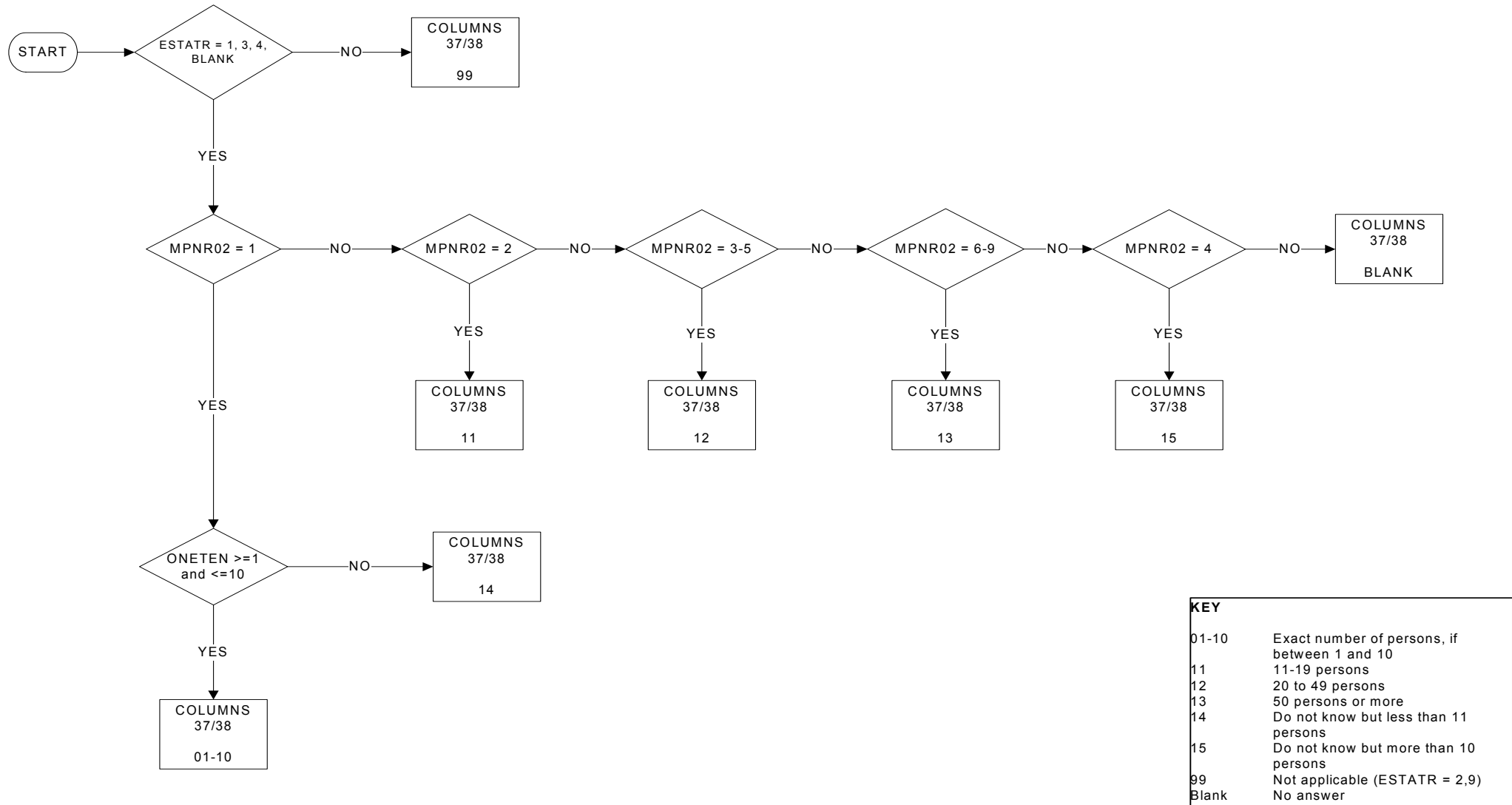

KEY	
01-10	Exact number of persons, if between 1 and 10
11	11-19 persons
12	20 to 49 persons
13	50 persons or more
14	Do not know but less than 11 persons
15	Do not know but more than 10 persons
99	Not applicable (ESTATR = 2,9)
Blank	No answer

COUNTRYW (ECONWRK): Country of place of work

Columns 39/40

PAGE 1 OF 7

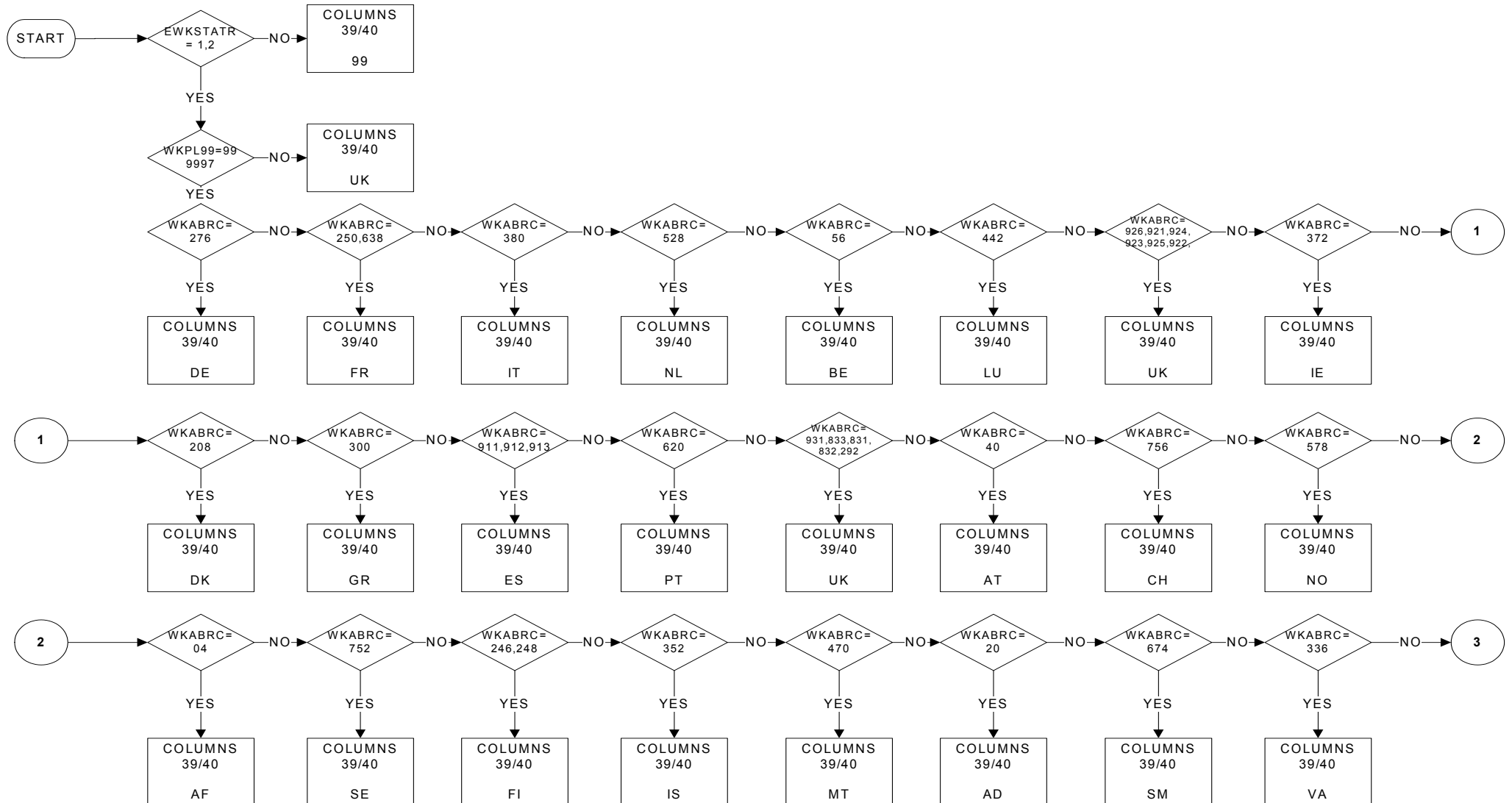

COUNTRYW (ECONWRK): Country of place of work

Columns 39/40

PAGE 2 OF 7

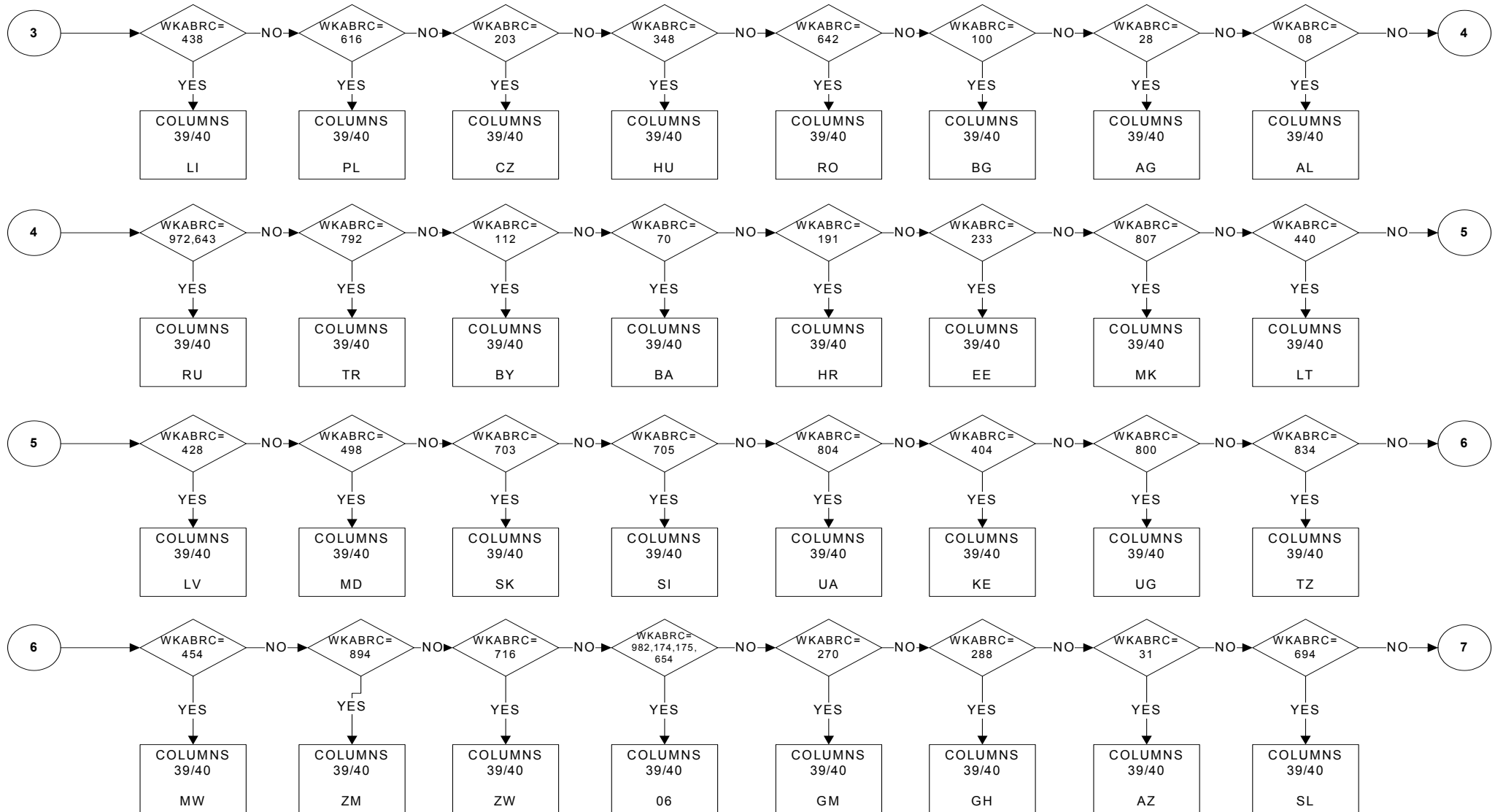

COUNTRYW (ECONWRK): Country of place of work

Columns 39/40

PAGE 3 OF 7

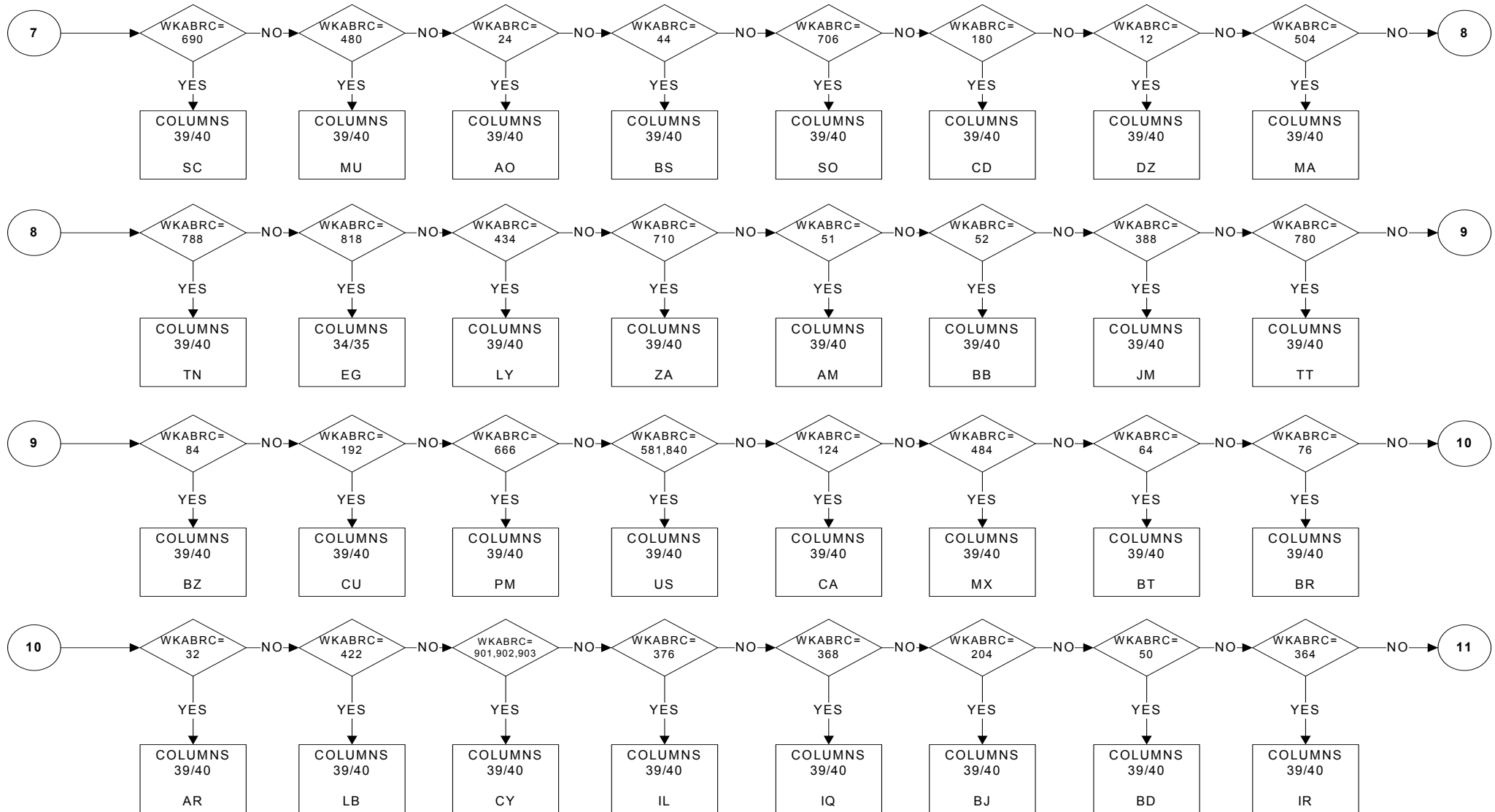

COUNTRYW (ECONWRK): Country of place of work

Columns 39/40

PAGE 4 OF 7

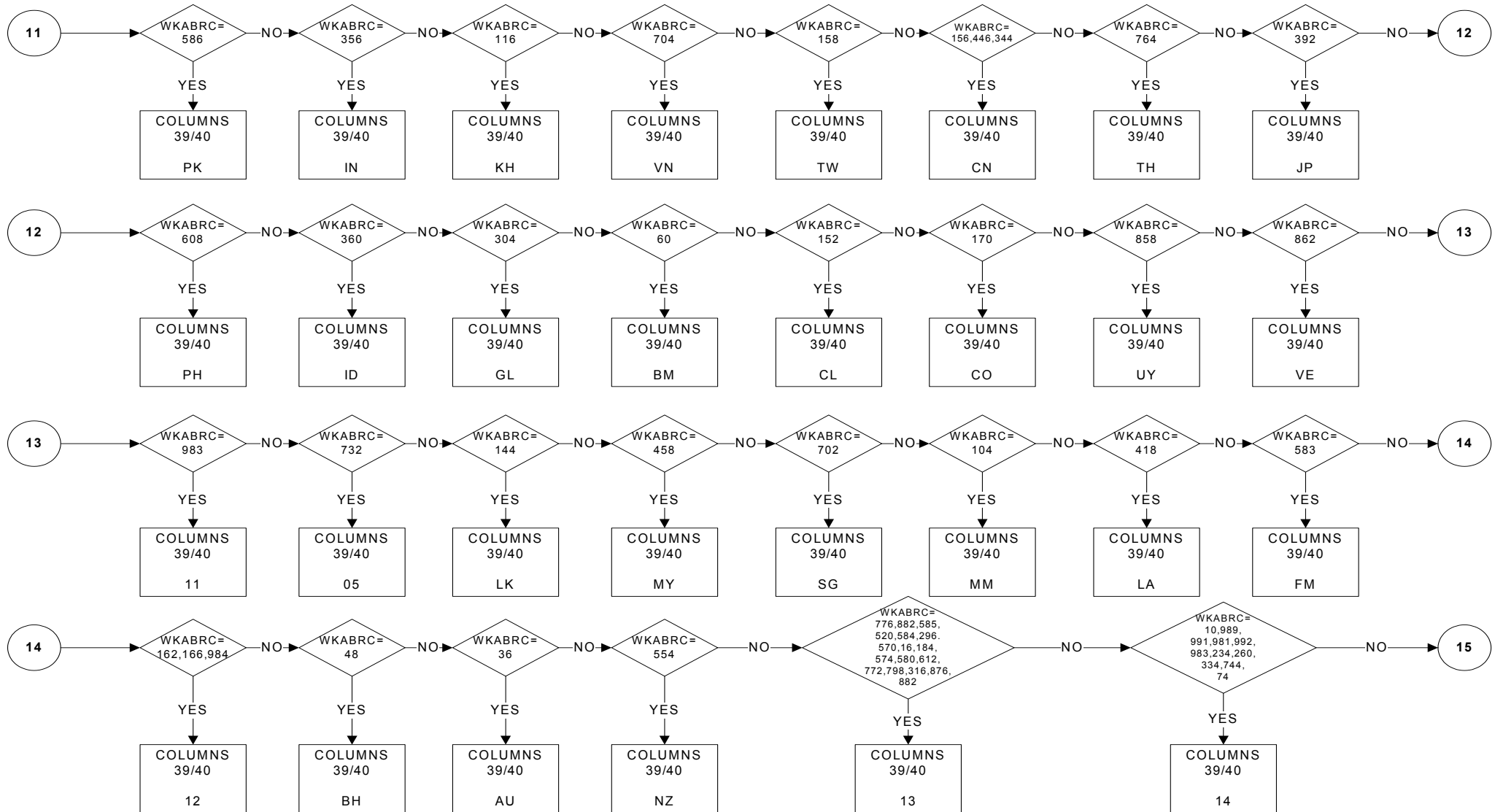

COUNTRYW (ECONWRK): Country of place of work

Columns 39/40

PAGE 5 OF 7

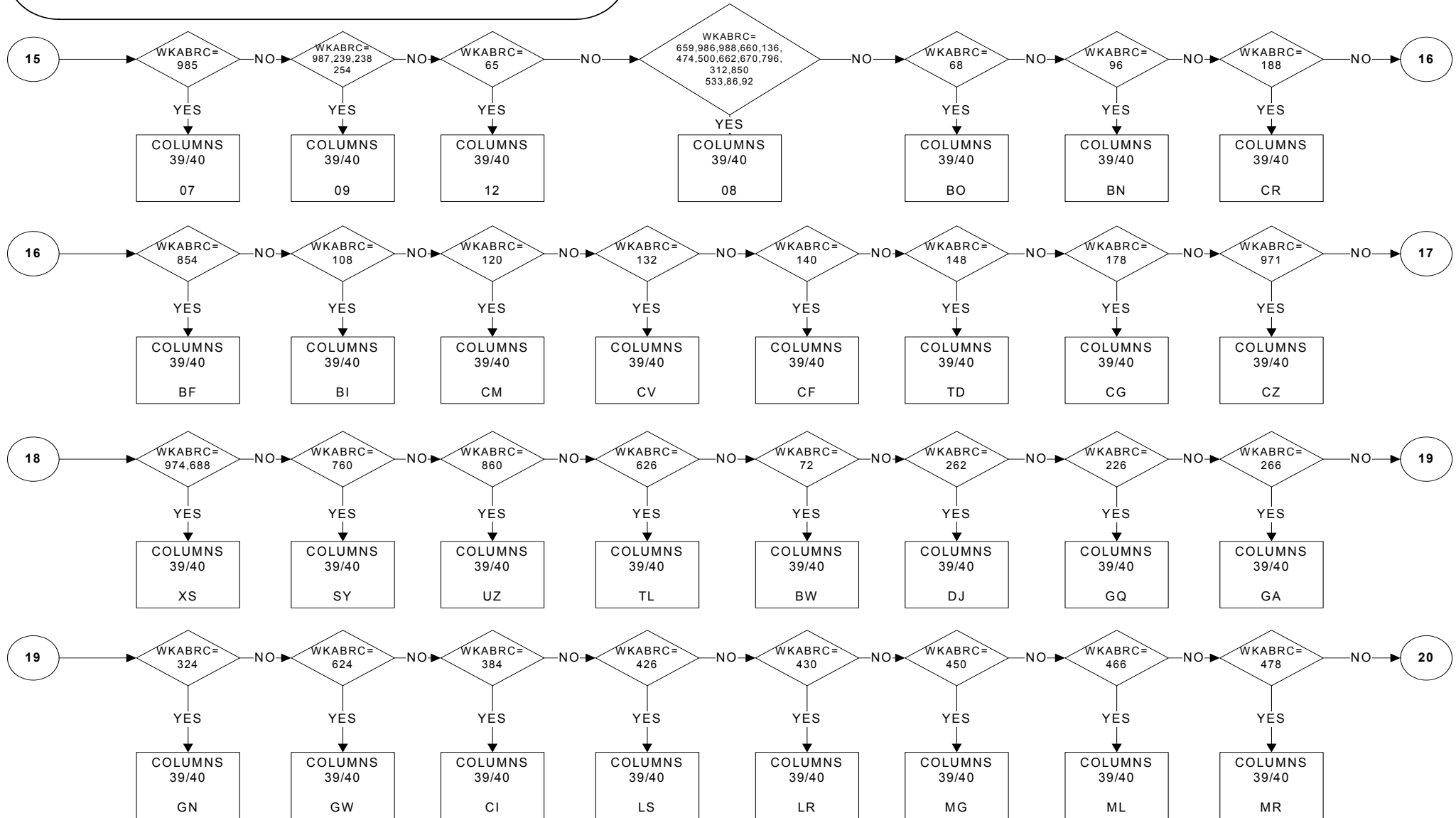

COUNTRYW (ECONWRK): Country of place of work

Columns 39/40

PAGE 6 OF 7

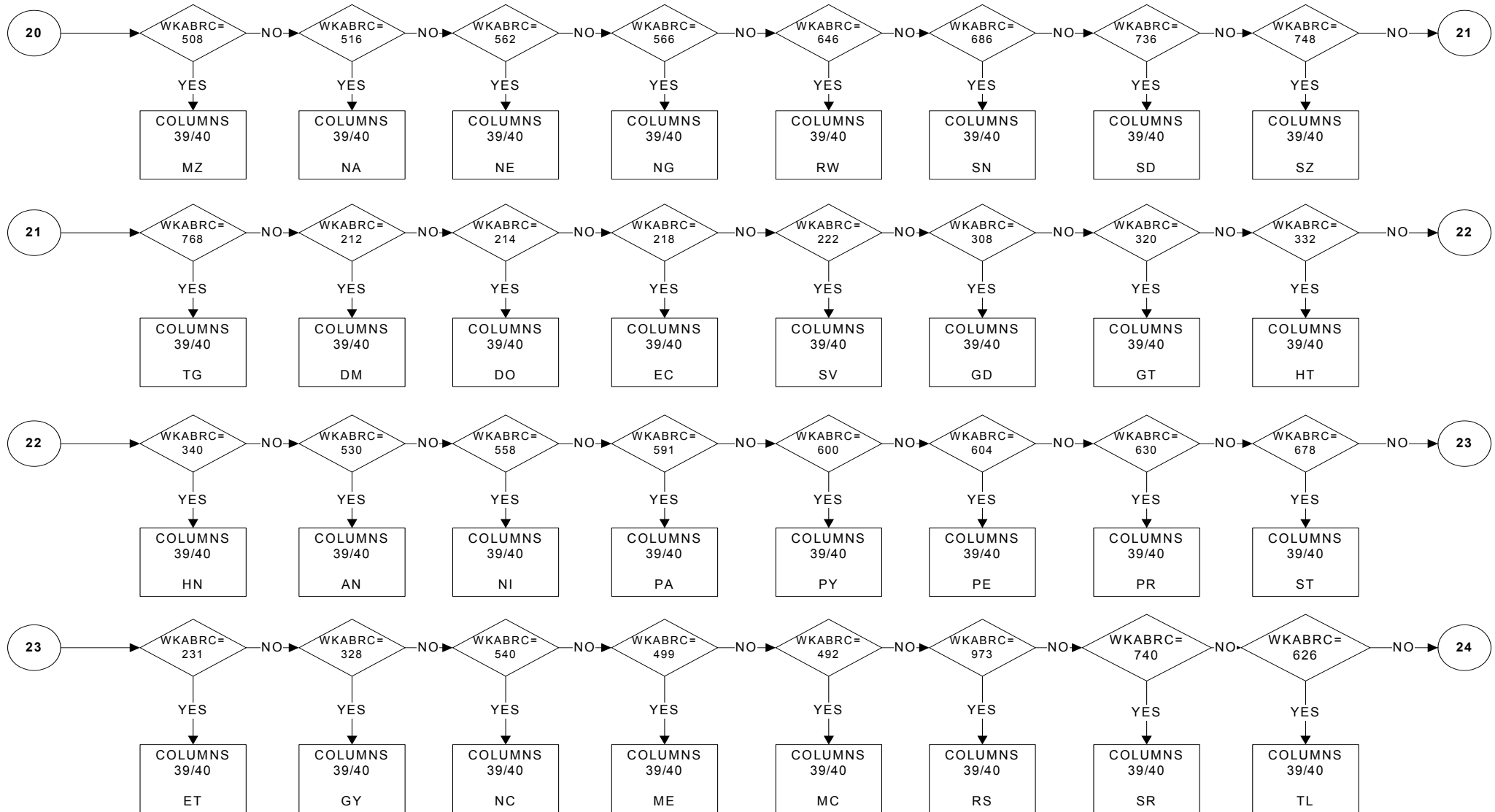

COUNTRYW (ECONWRK): Country of place of work

Columns 39/40

PAGE 7 OF 7

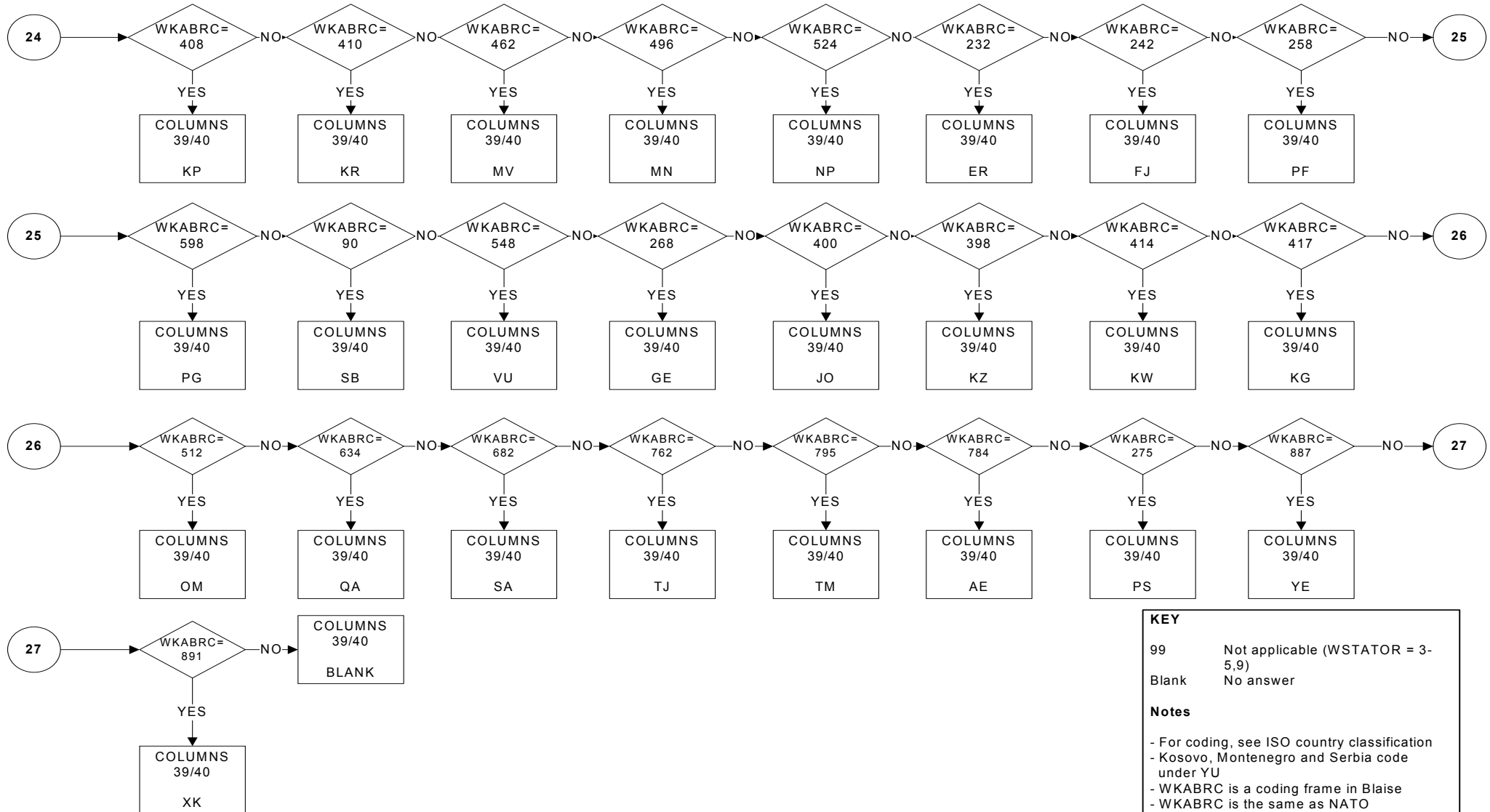

KEY

99 Not applicable (WSTATOR = 3-5,9)
Blank No answer

Notes

- For coding, see ISO country classification
- Kosovo, Montenegro and Serbia code under YU
- WKABRC is a coding frame in Blaise
- WKABRC is the same as NATO

REGIONW (EREGWKR): Region of place of work

Columns 41/42

PAGE 1 OF 5

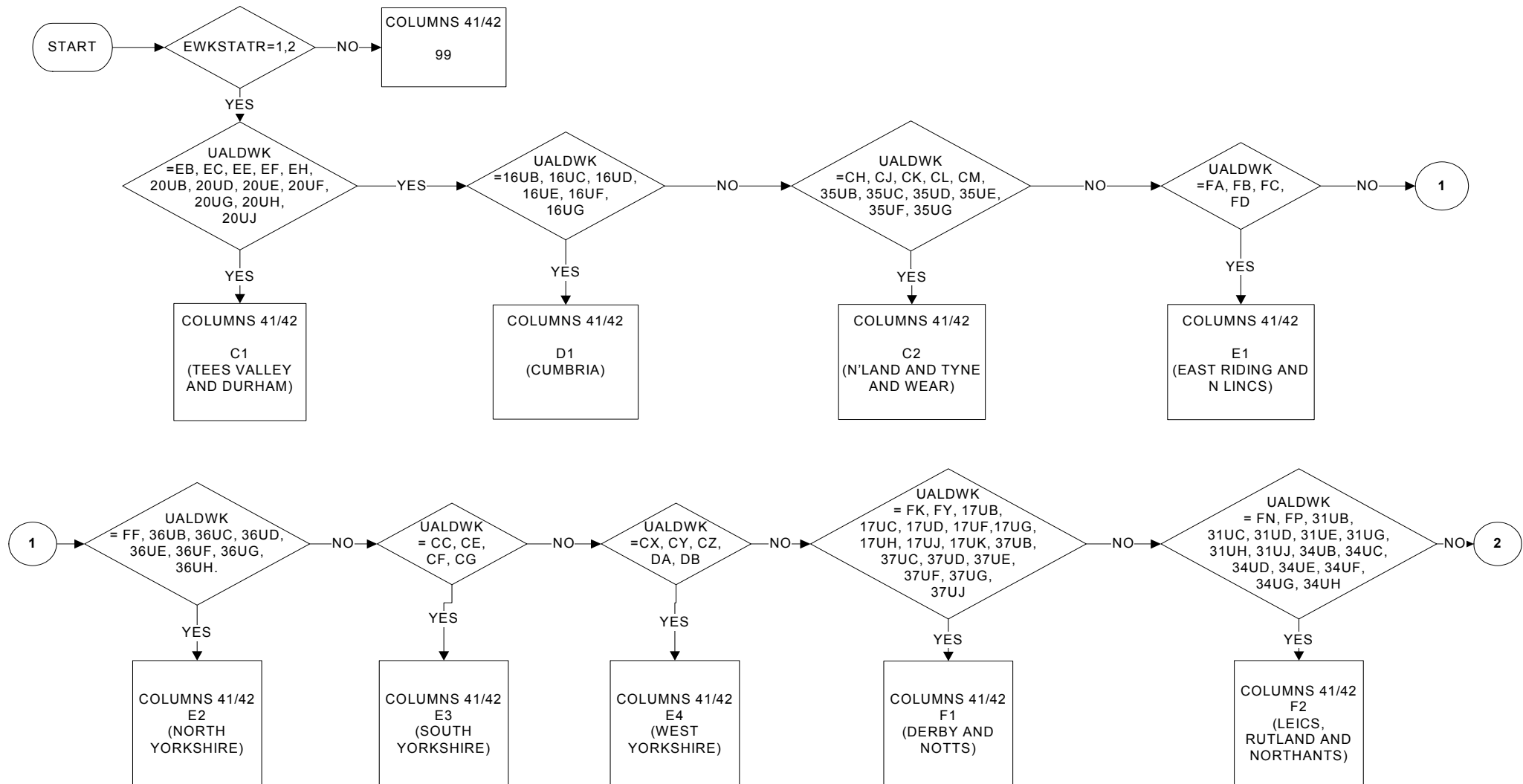

REGIONW (EREGWKR): Region of place of work

Columns 41/42

PAGE 2 OF 5

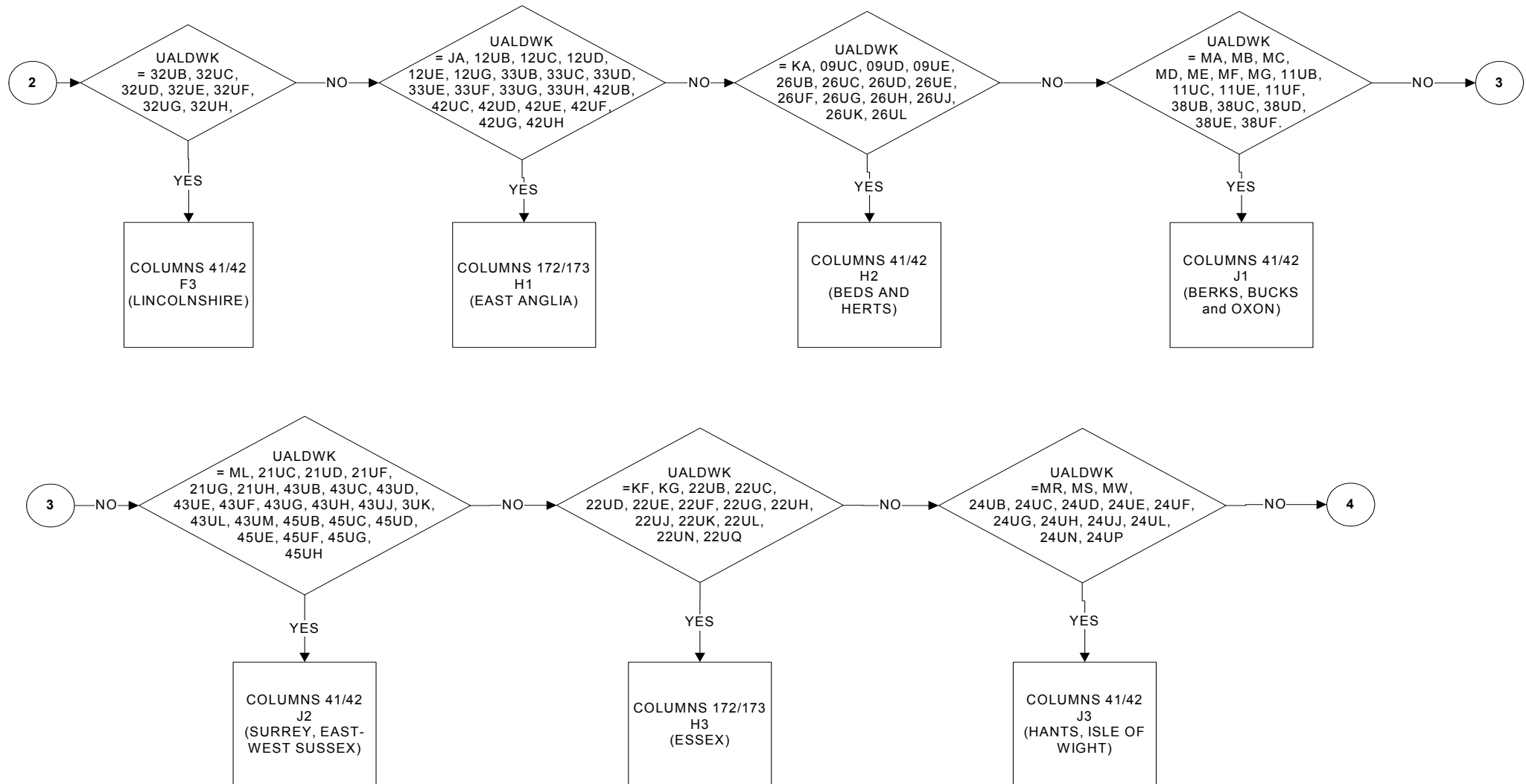

REGIONW (EREGWKR): Region of place of work

Columns 41/42

PAGE 3 OF 5

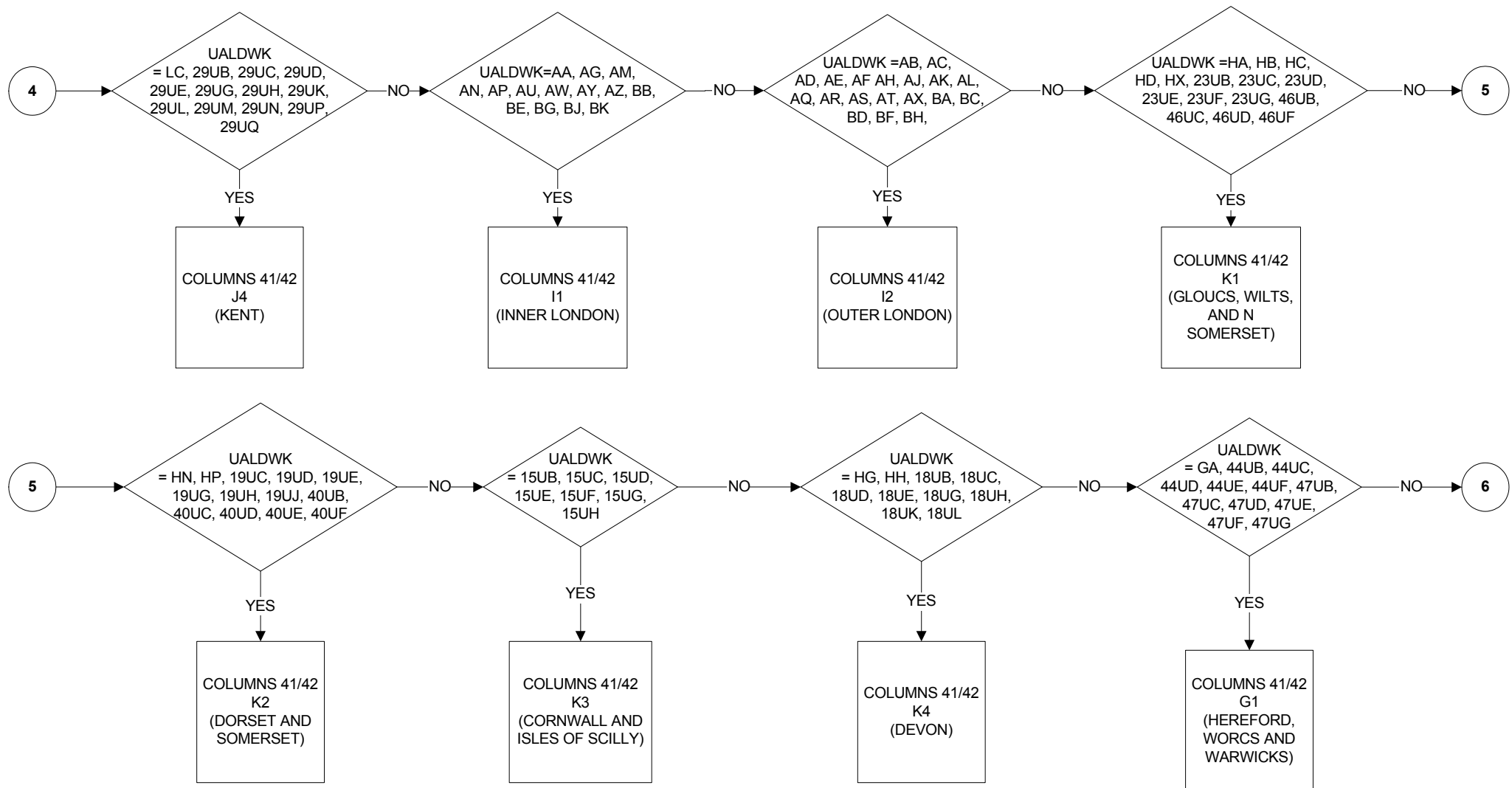

REGIONW (EREGWKR): Region of place of work

Columns 41/42

PAGE 4 OF 5

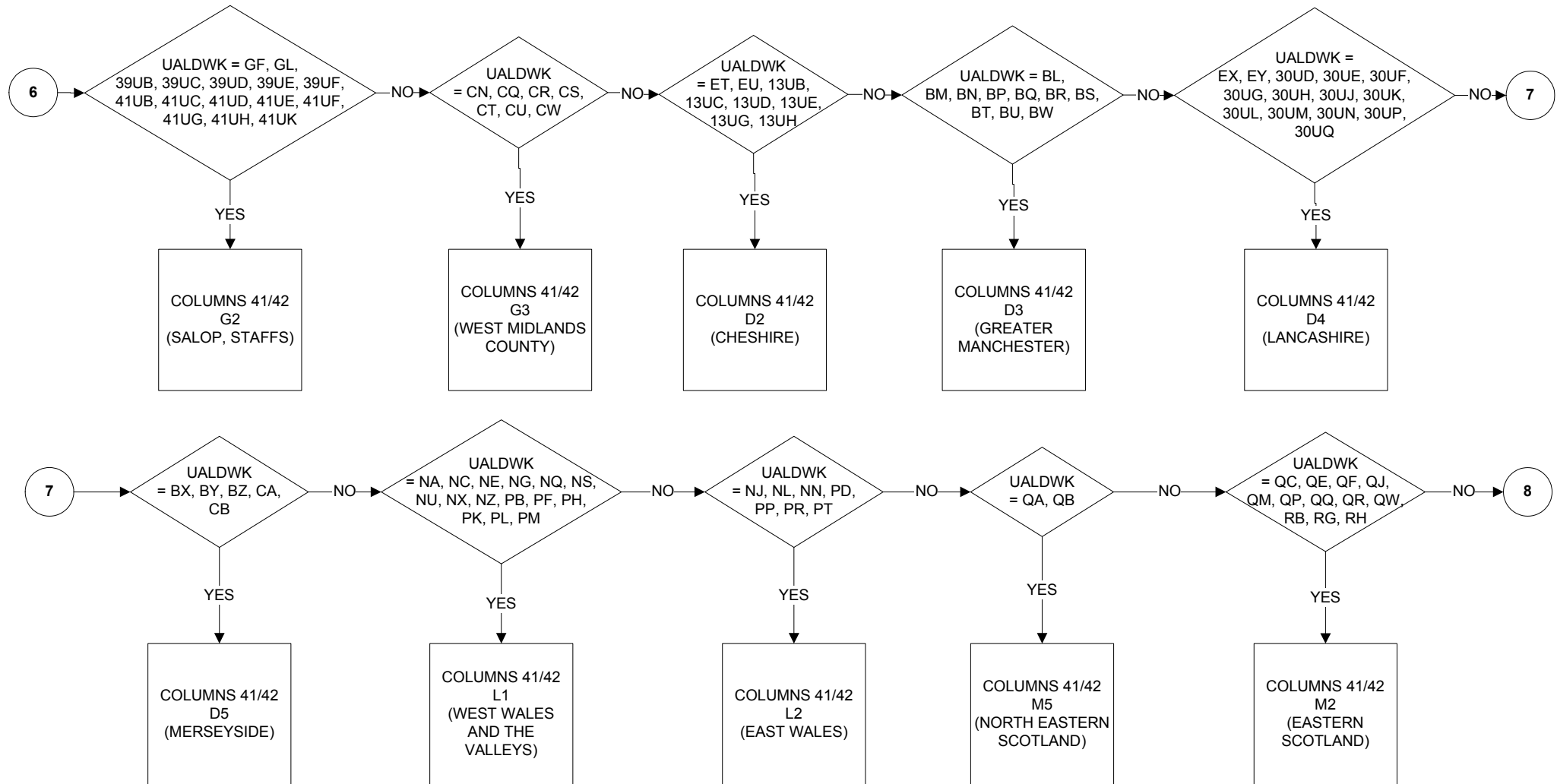

REGIONW (EREGWKR): Region of place of work

Columns 41/42

PAGE 5 OF 5

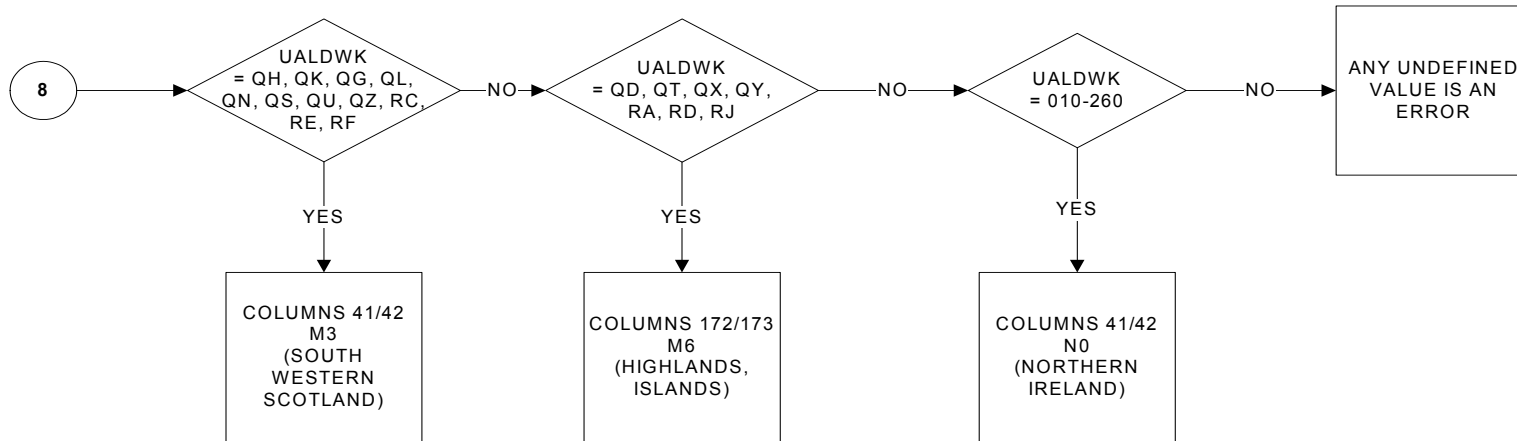

KEY	
99	Not applicable (WSTATOR = 3-5,9)
blank	No answer

YSTARTWK (EYRSTRTR): Year in which person started working for this employer or as self-employed

Columns 43/46

PAGE 1 OF 1

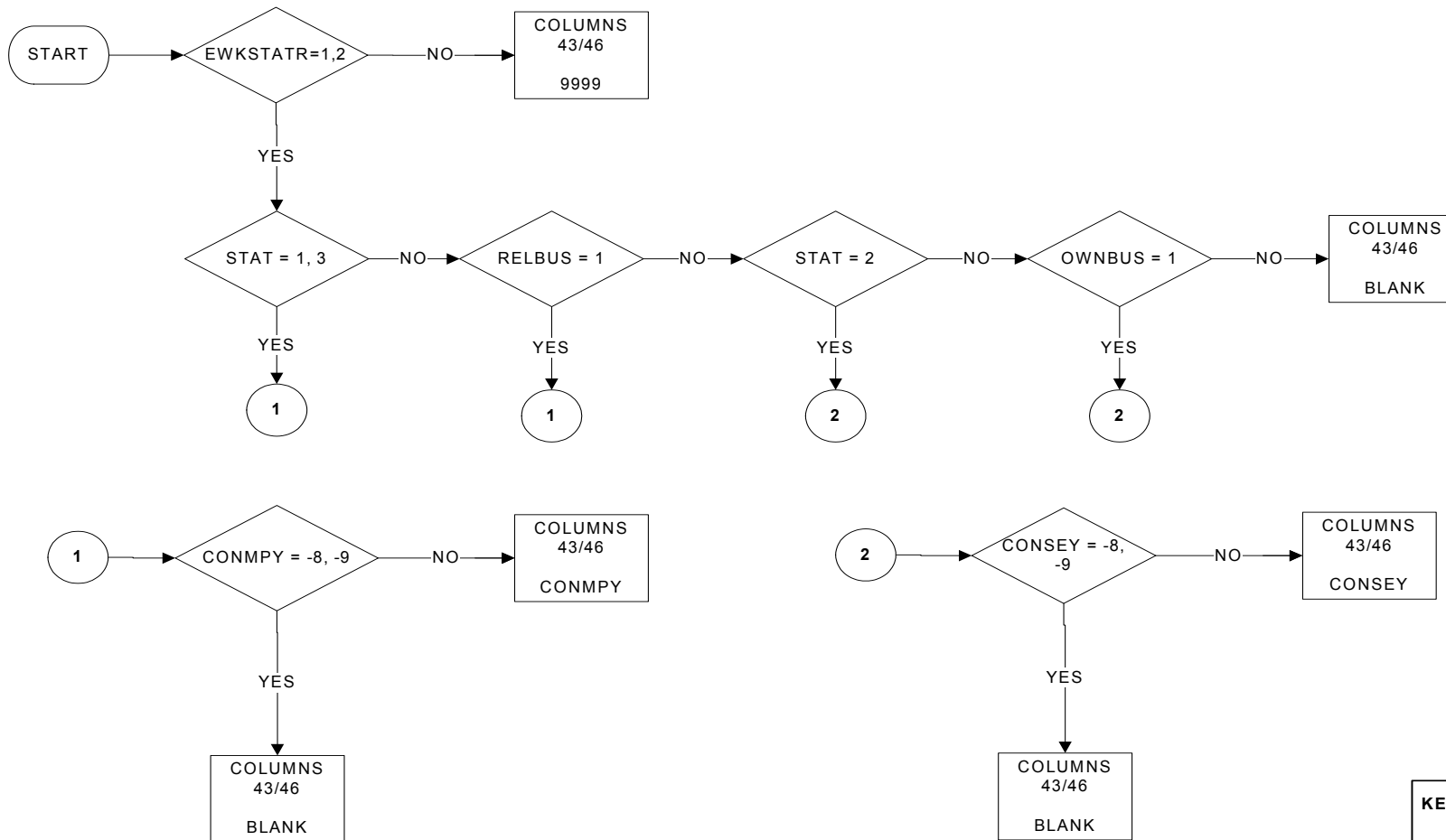

KEY	
	Enter the 4 digits of the year concerned
9999	Not applicable (WSTATOR = 3-5,9)
blank	No answer

MSTARTWK (EMNSTRTR): Month started with current employer/self-employed

Columns 47/48

PAGE 1 OF 1

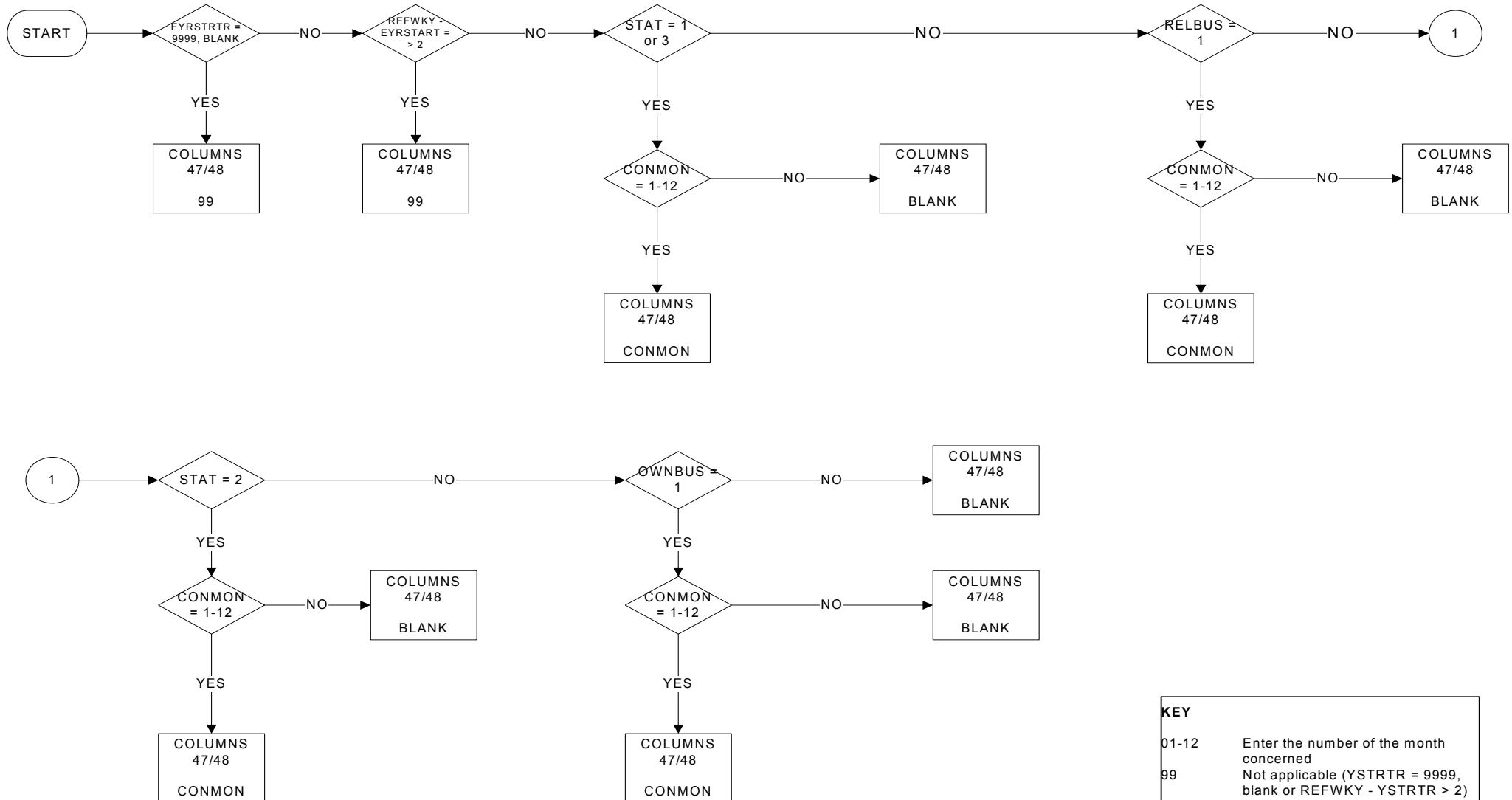

KEY	
01-12	Enter the number of the month concerned
99	Not applicable (YSTRTR = 9999, blank or REFWKY - YSTRTR > 2)
blank	No answer

WAYJFOUN (EHOWGET): Involvement of the public employment office at any moment in finding the present job

Column 49

PAGE 1 OF 1

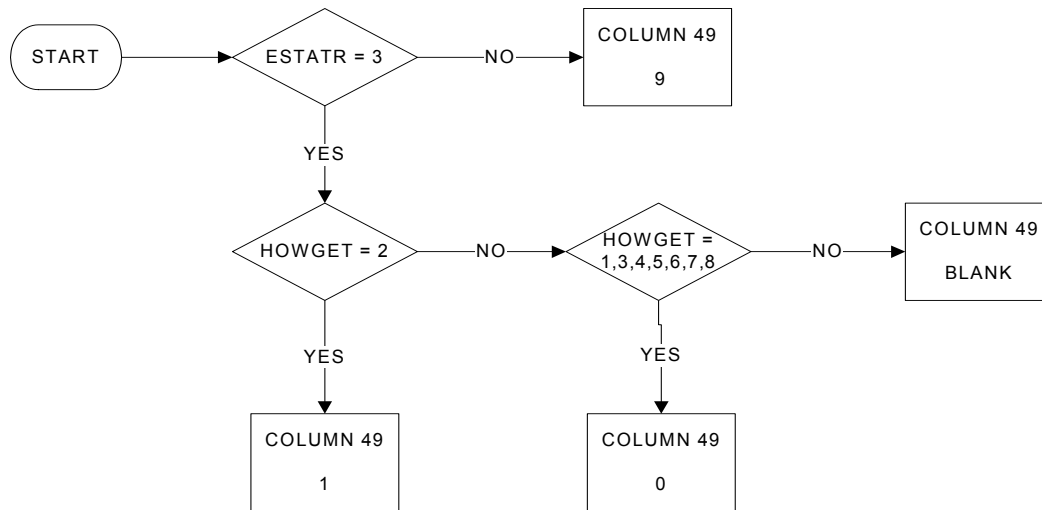

KEY	
0	No
1	Yes
9	Not Applicable (STAPRO is not equal to 3 or has started this job more than 1 year ago)
blank	No answer

FTPT (EFTPTWKR): Full-time/part-time distinction

Column 50

PAGE 1 OF 1

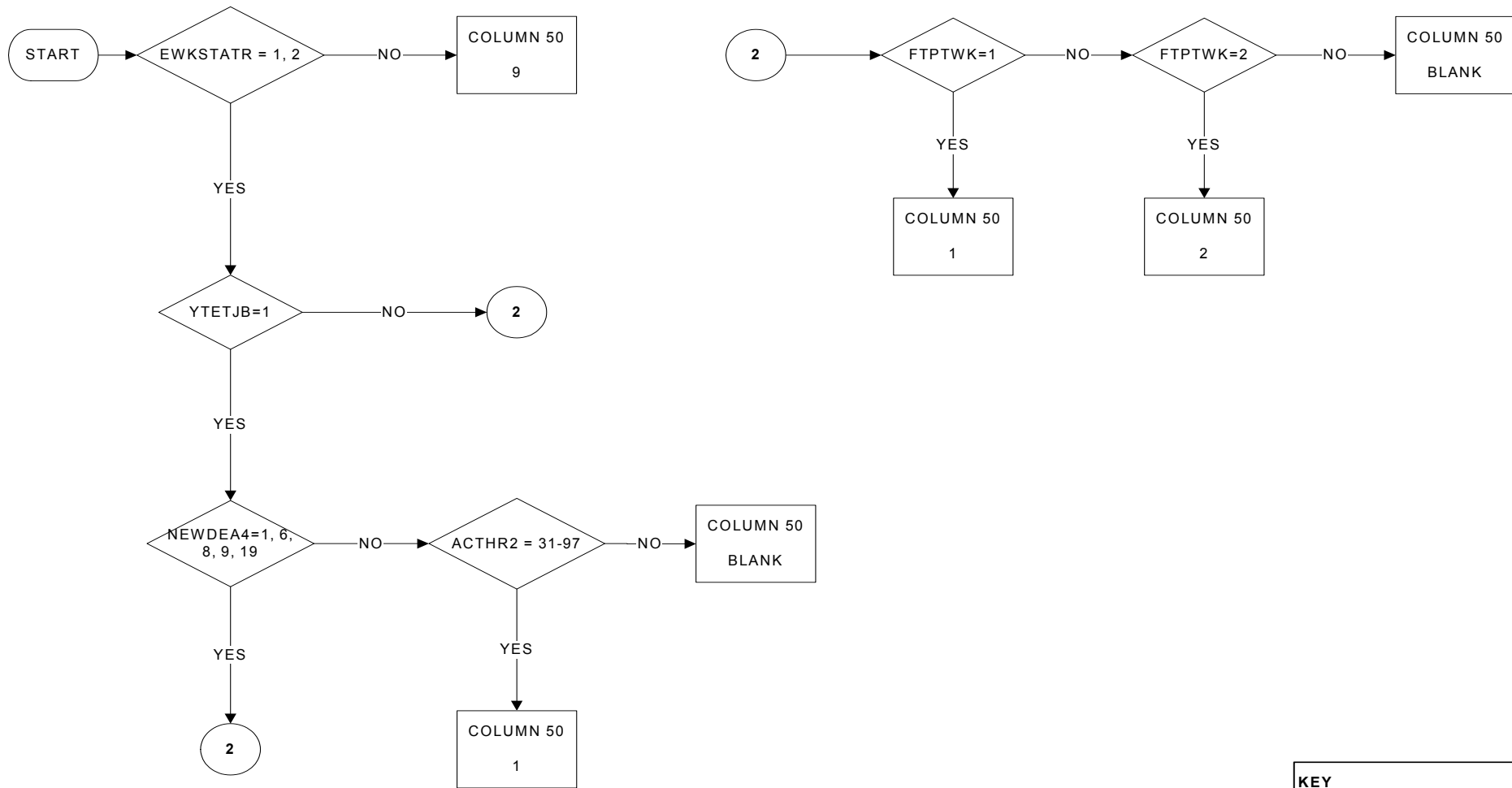

KEY	
1	Full-time job
2	Part-time job
9	Not applicable (EWKSTATR ? 1,2)
BLANK	No answer

FTPTREAS (EYPTJOB): Reasons for part-time work

Column 51
PAGE 1 OF 1

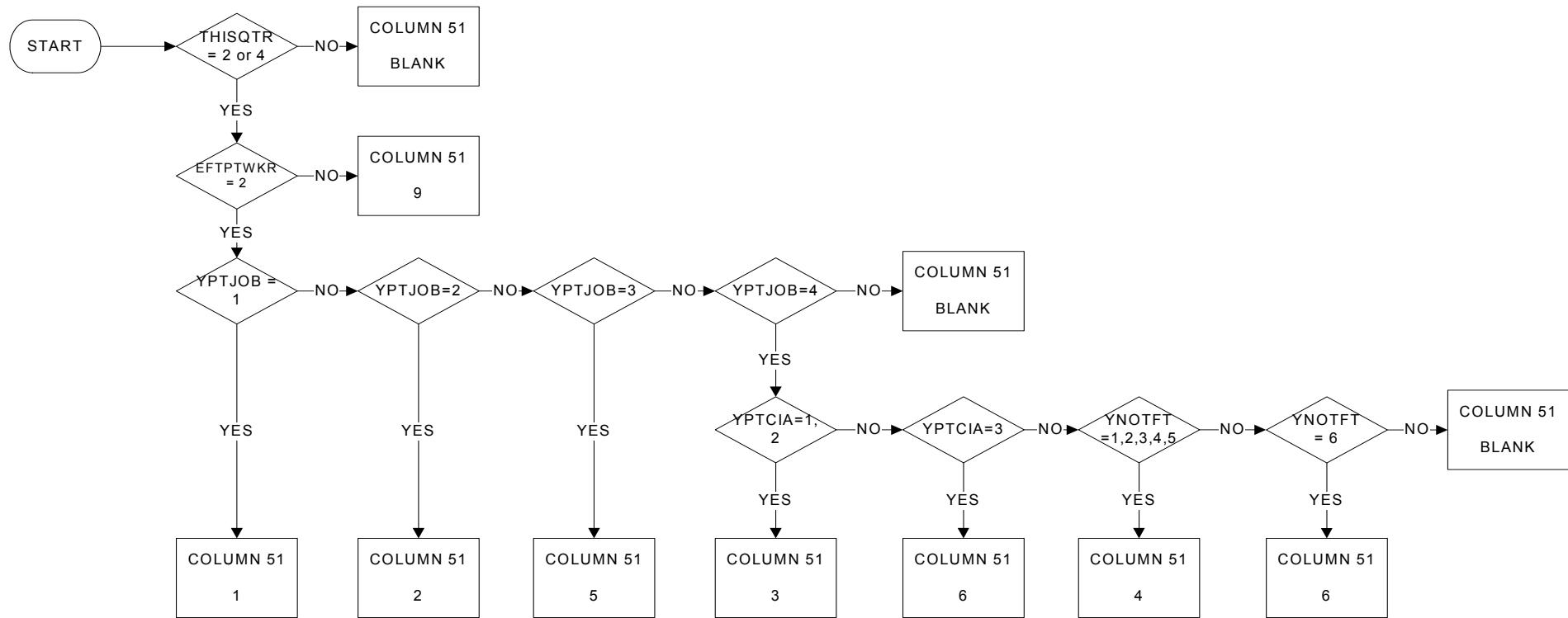

KEY	
1	Person is undergoing school education or training
2	Of own illness or disability
3	Looking after children or incapacitated adults
4	Other personal or family reasons
5	Person could not find a full-time job
6	Of other reasons
9	Not applicable (FTPT ? 2)
BLANK	No answer

TEMP (EPERMR): Permanency of first job

Column 52

PAGE 1 OF 1

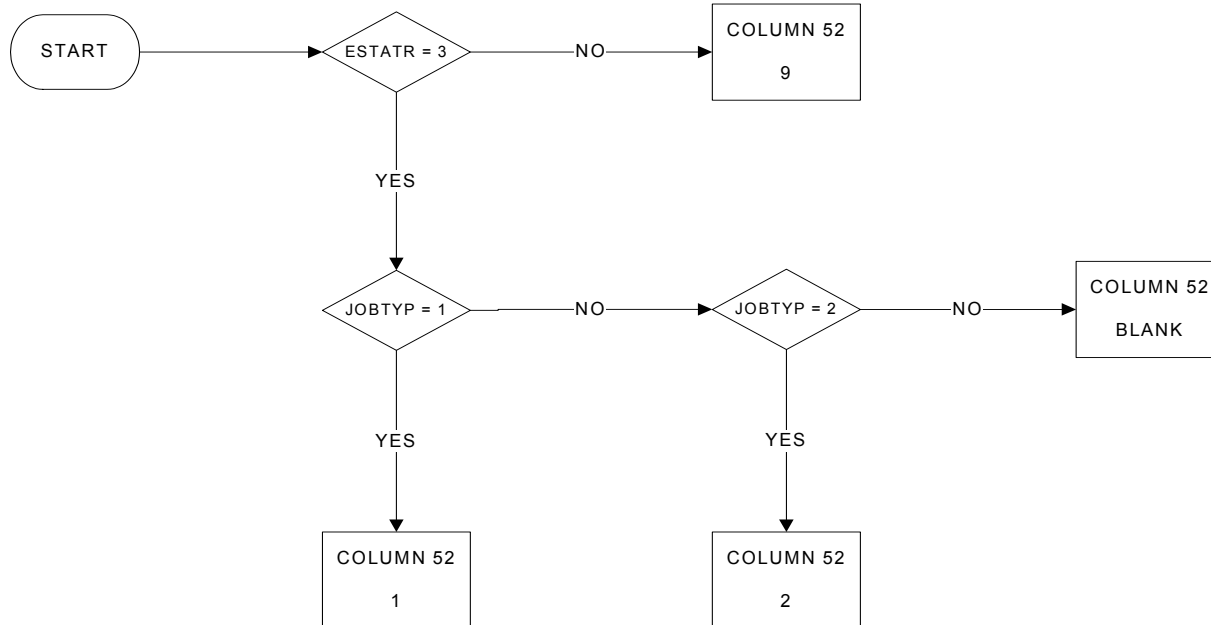

KEY

- 1 Person has a permanent job or work contract of unlimited duration
- 2 Person has temporary job/work contract of limited duration
- 9 Not applicable (ESTATR ? 3)
- Blank No answer

TEMPREAS (EWHYTMP): Reasons for having a temporary job/work contract of limited duration

Column 53

PAGE 1 OF 1

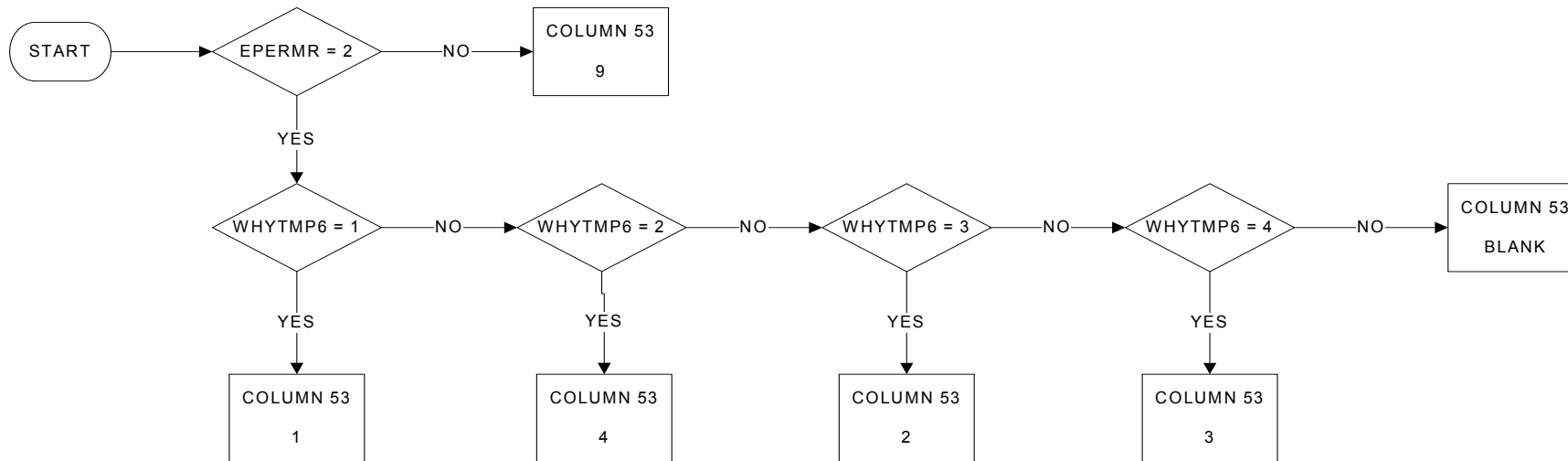

KEY	
1	It is a contract covering a period of training (apprentices, trainees, research assistants, etc.)
2	Person could not find a permanent job
3	Person did not want a permanent job
4	It is a contract for a probationary period
9	Not applicable (TEMP ? 2)
blank	No answer

TEMPDUR (EDURTPR): Duration of temporary job

Column 54
PAGE 1 OF 1

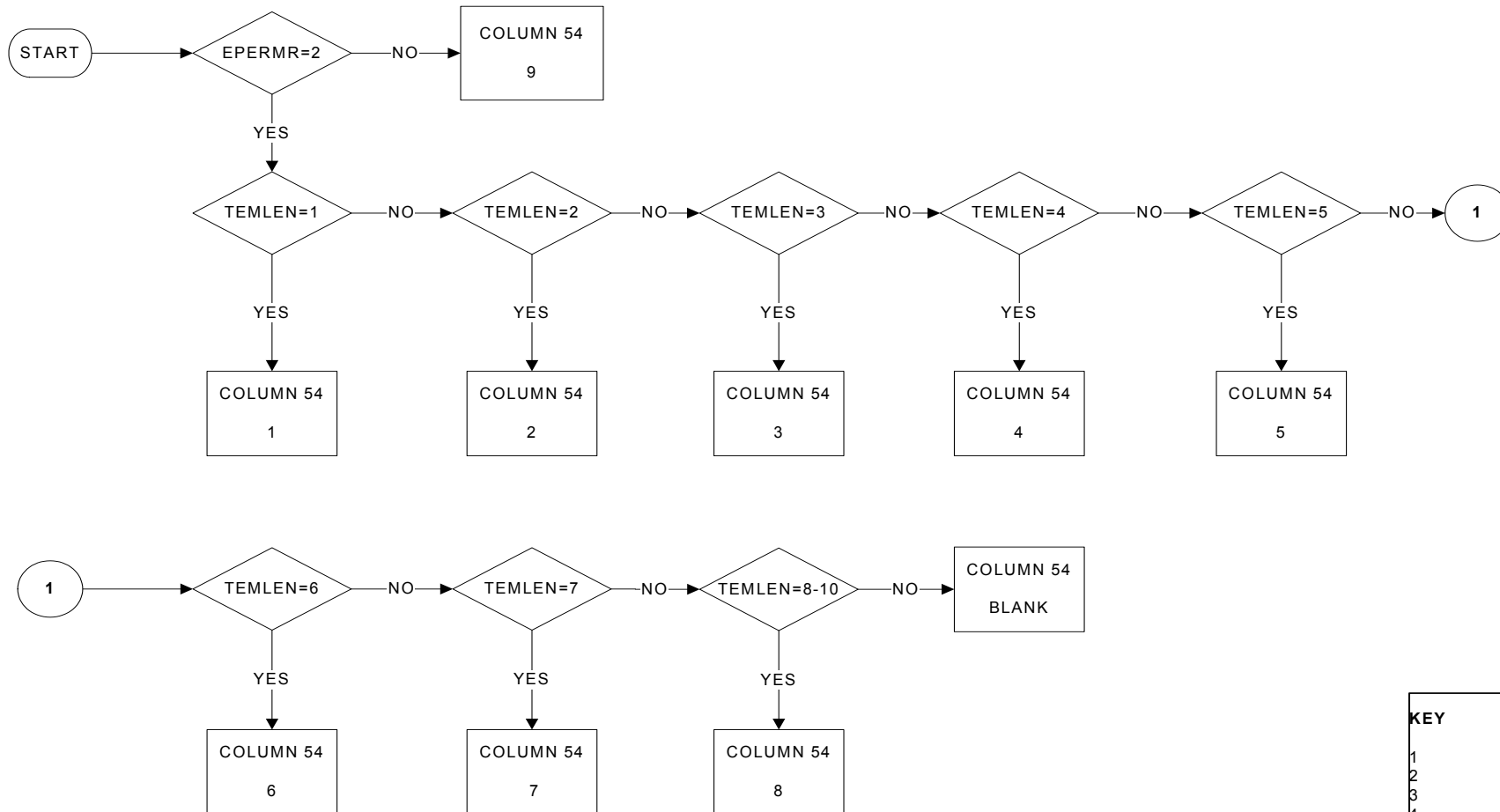

KEY

1	Less than one month
2	1 to 3 months
3	4 to 6 months
4	7 to 12 months
5	13 to 18 months
6	19 to 24 months
7	25 to 36 months
8	More than 3 years
9	Not applicable (TEMP is not equal to 2)
Blank	No answer

TMPAGCY (ETMPCON): Contract with a temporary employment agency

Column 55

PAGE 1 OF 1

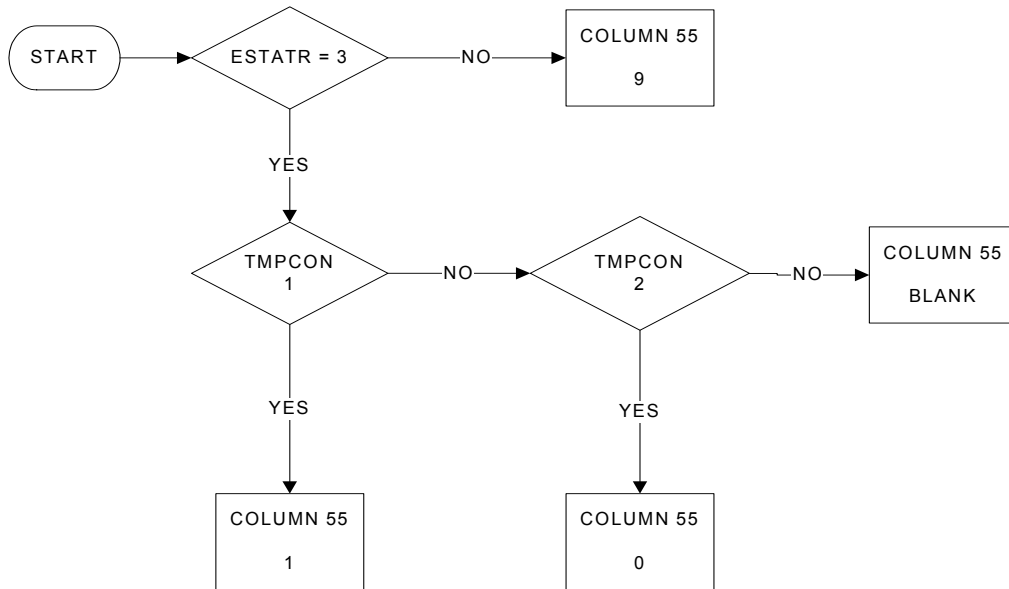

KEY	
0	No
1	Yes
9	Not applicable (STAPRO ? 3)
blank	No answer

SHIFTWK (ESHIFTR): Shift work

Column 56
PAGE 1 OF 1

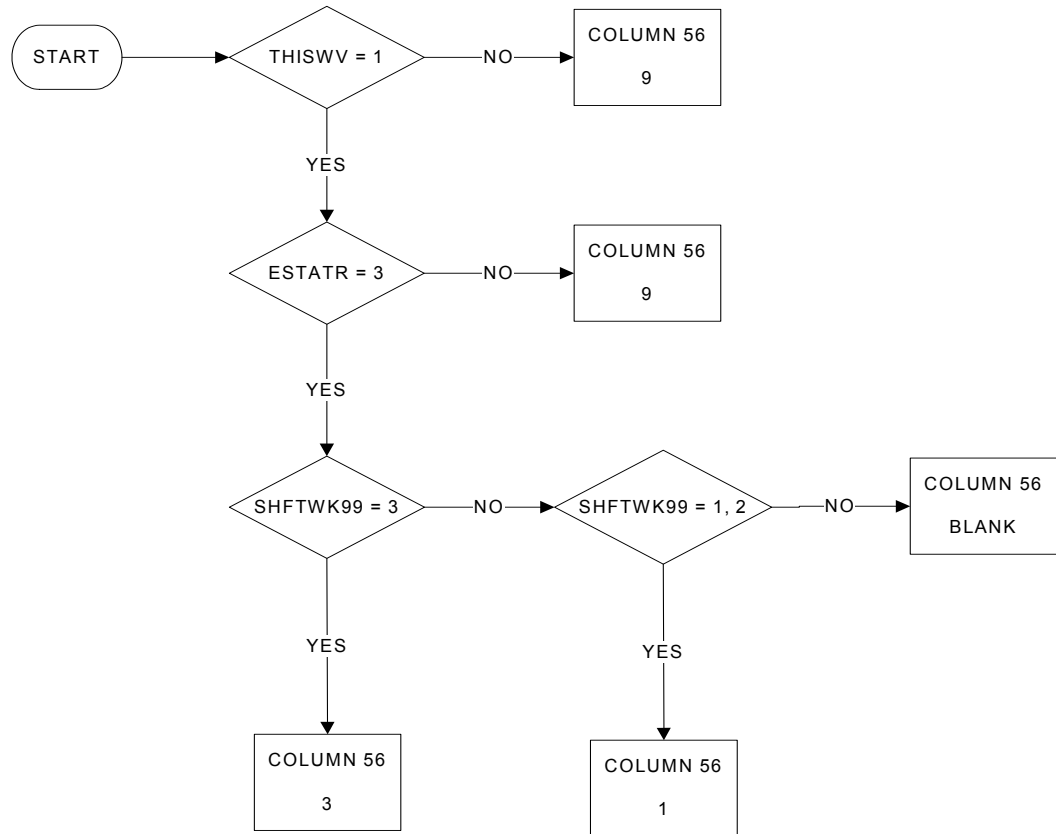

KEY	
1	Person does shift work
3	Person never does shift work
9	Not applicable (STAPRO ? 3)
Blank	No answer

EVENWK (EEVENR): Evening work in main job

Column 57
PAGE 1 OF 1

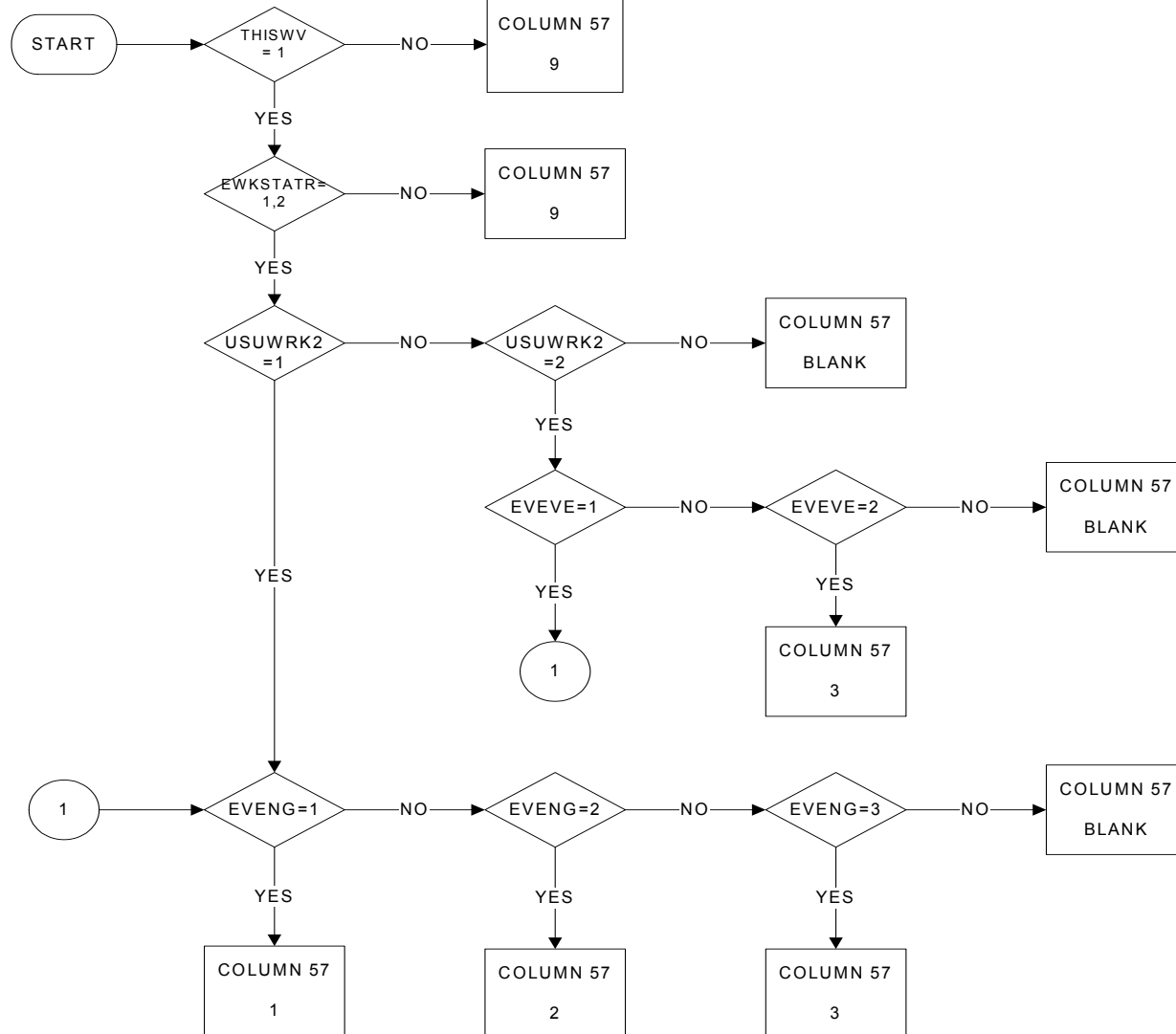

KEY	
1	Person usually works in the evening
2	Person sometimes works in the evening
3	Person never works in the evening
9	Not applicable (WSTATOR = 3-5,9)
BLANK	No Answer

NIGHTWK (ENIGHTR): Night work in main job

Column 58
PAGE 1 OF 1

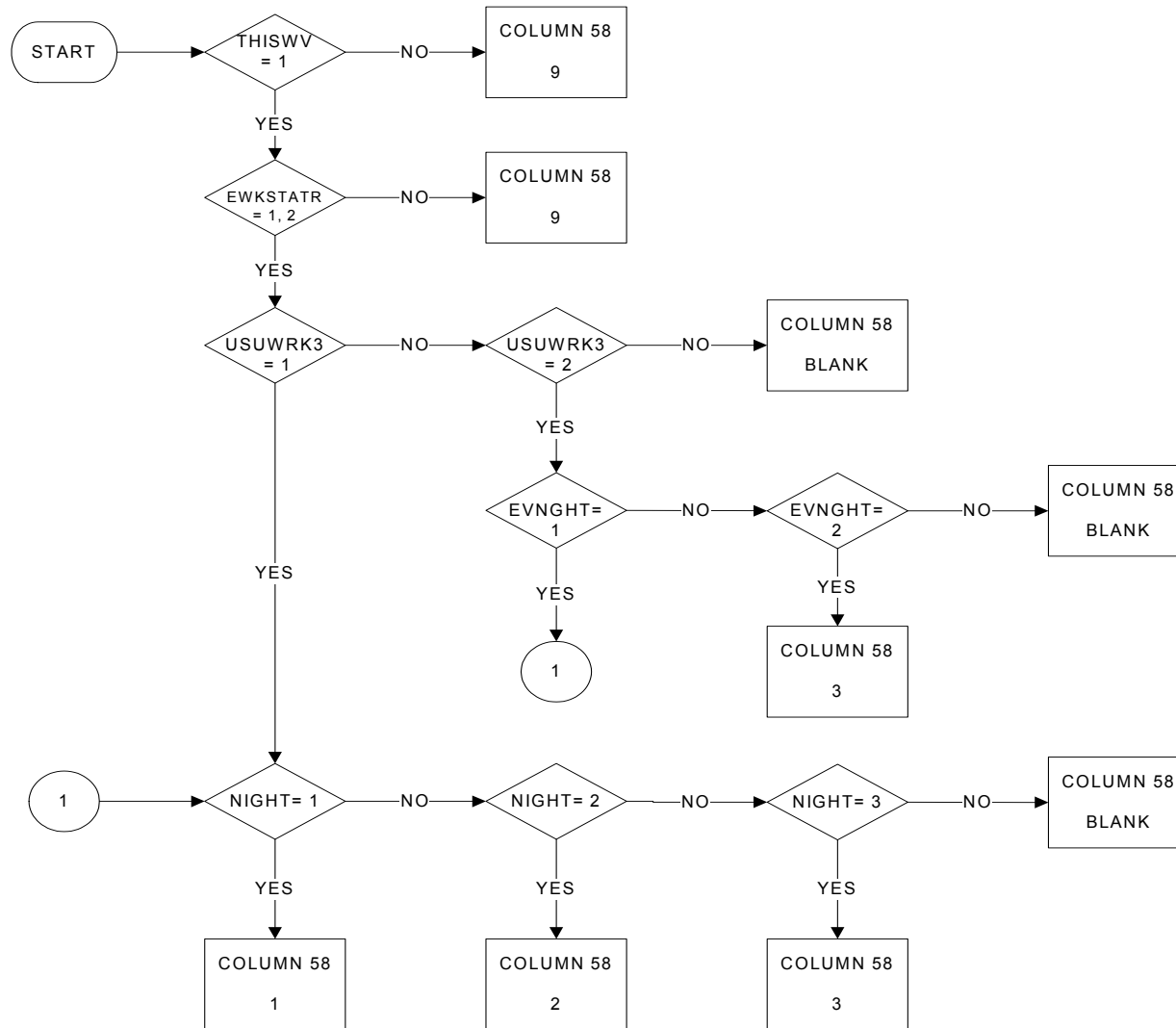

KEY	
1	Person usually works at night
2	Person sometimes works at night
3	Person never works at night
9	Not applicable (WSTATOR = 3-5,9)
BLANK	No Answer

SATWK (ESATR): Saturday work in main job
 Column 59
 PAGE 1 OF 1

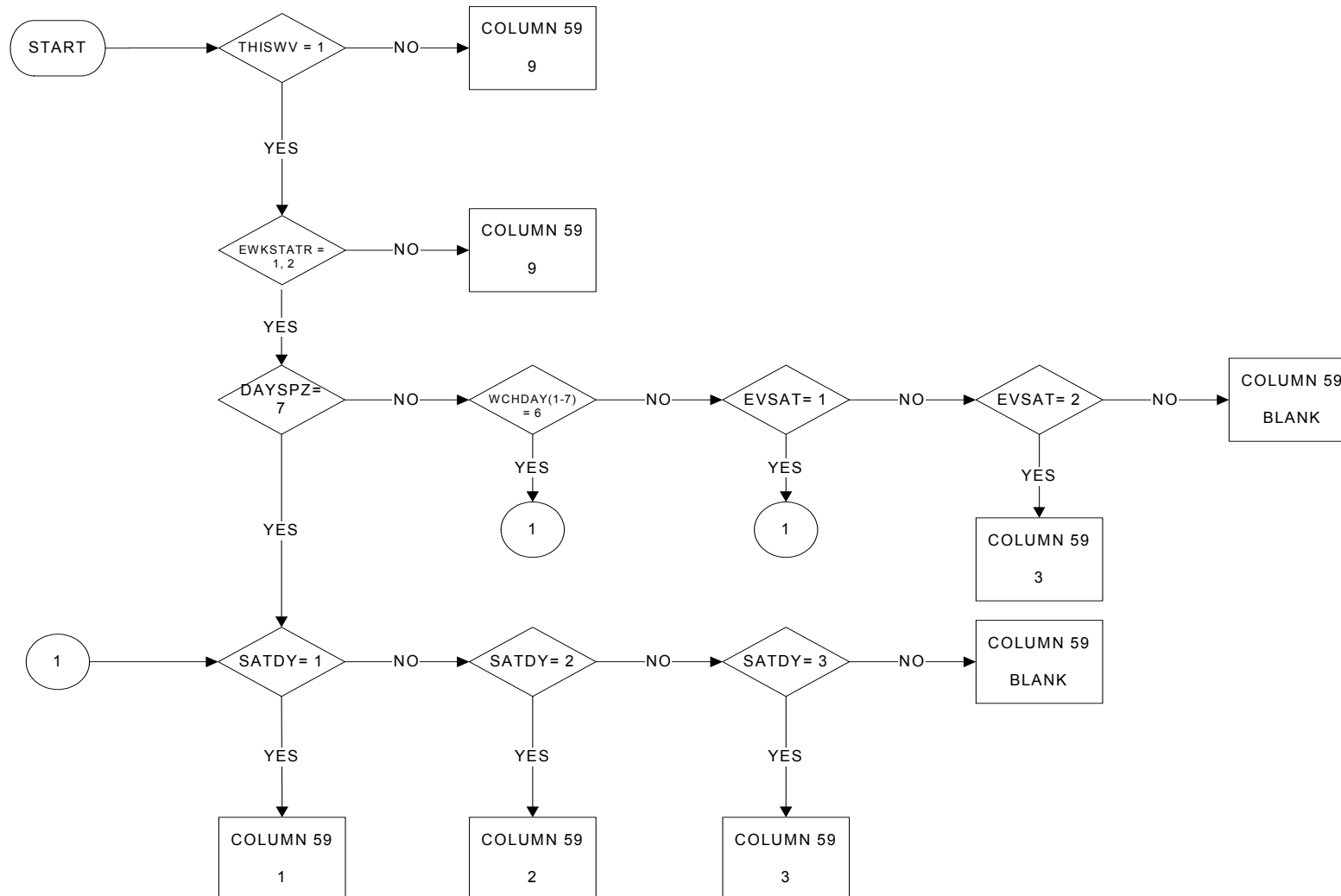

KEY	
1	Person usually works on Saturdays
2	Person sometimes works on Saturdays
3	Person never works on Saturdays
9	Not applicable (WSTATOR = 3-5,9)
Blank	No Answer

SUNWK (ESUNR): Sunday work

Column 60
PAGE 1 OF 1

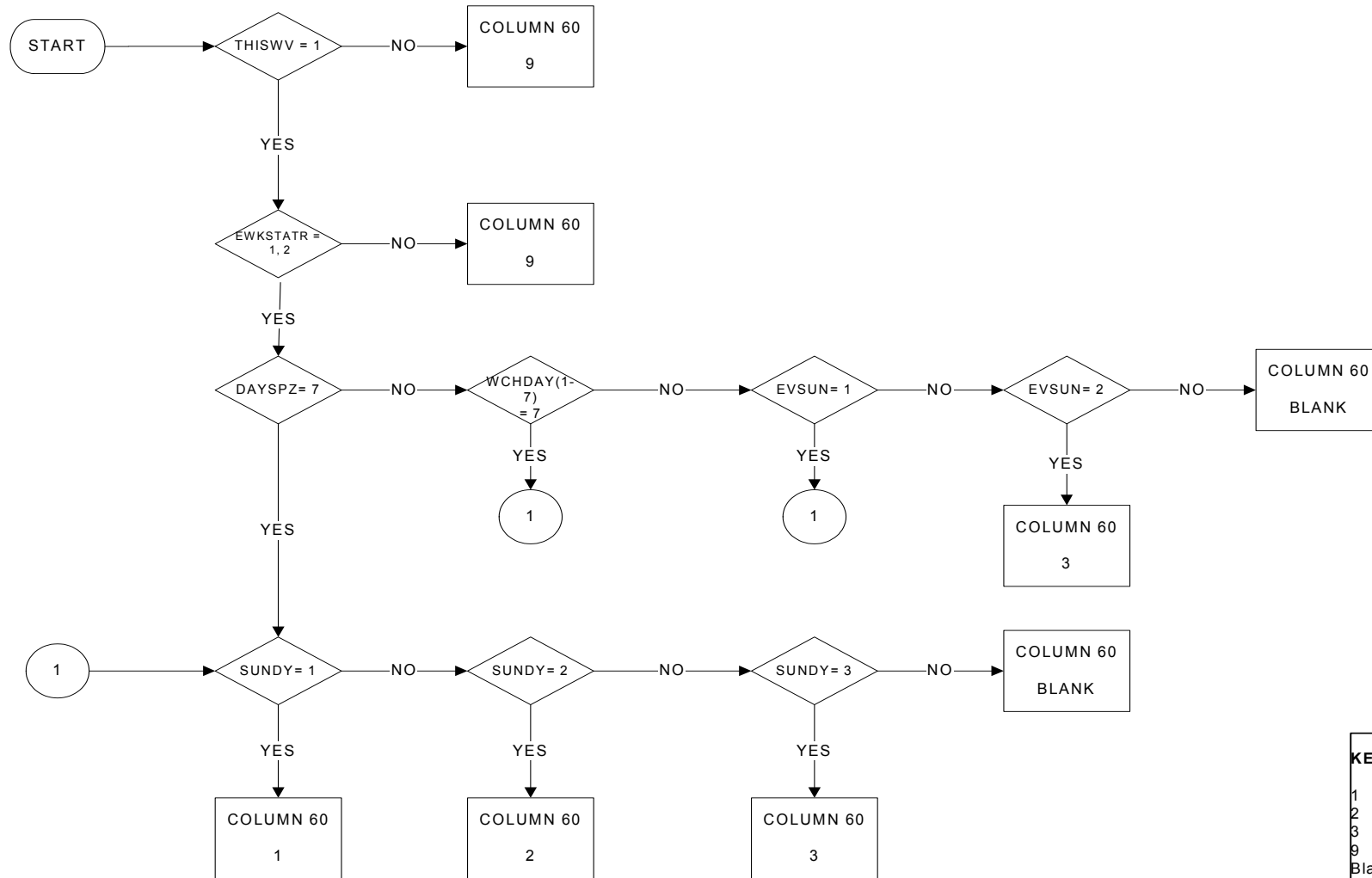

KEY	
1	Person usually works on Sundays
2	Person sometimes works on Sundays
3	Person never works on Sundays
9	Not applicable (WSTATOR = 3-5,9)
Blank	No Answer

HWUSUAL (EUSUHR): Number of hours usually worked in main job

Columns 61/62

PAGE 1 OF 1

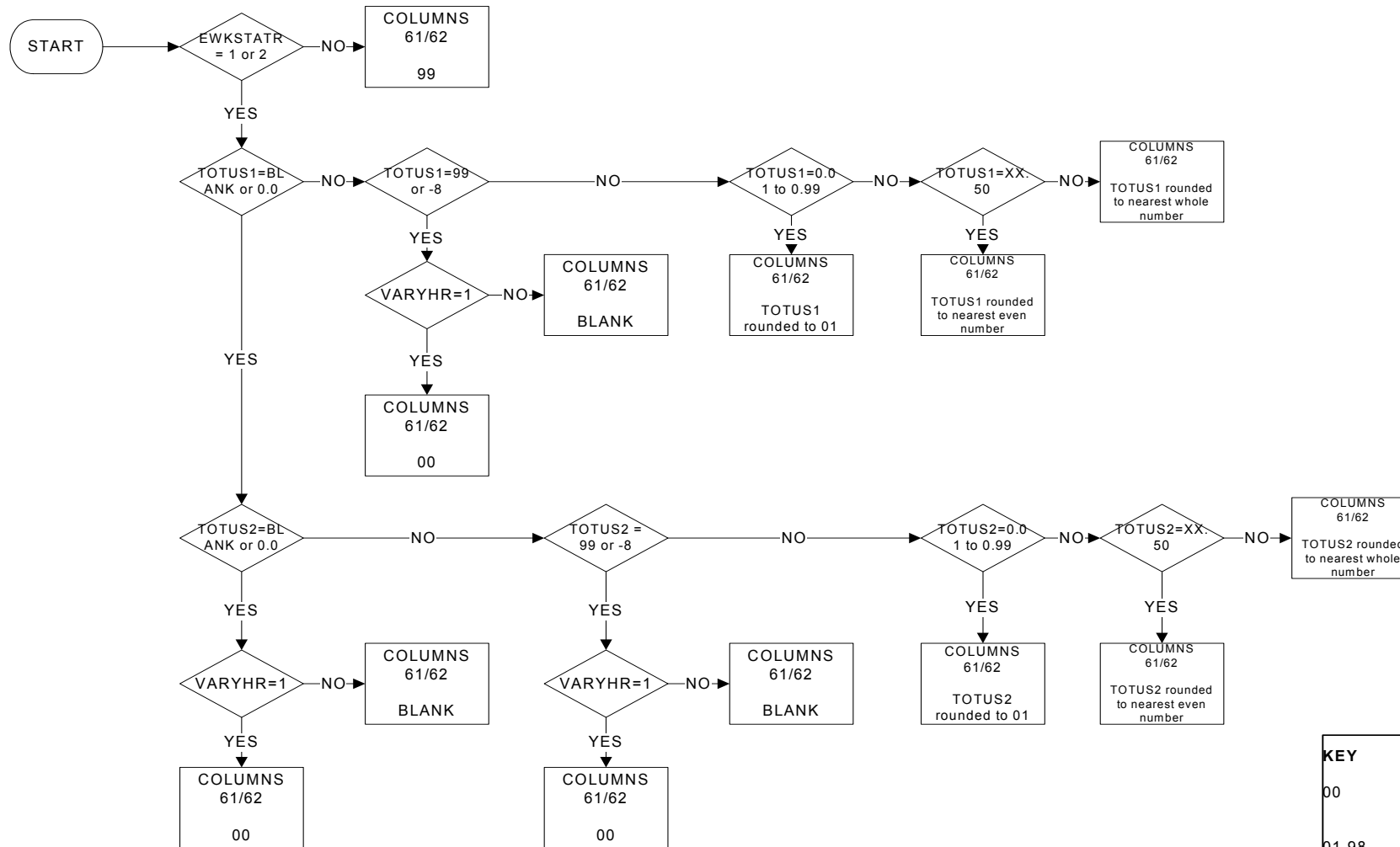

KEY

- 00 Usual hours cannot be given because hours worked vary considerably from week to week or from month to month
- 01-98 Number of hours usually worked in the main job
- 99 Not applicable (WSTATOR = 3-5, 9)
- BLANK No answer

HWACTUAL (EACTHRR): Number of hours actually worked during reference week in main job

Columns 63/64

PAGE 1 OF 1

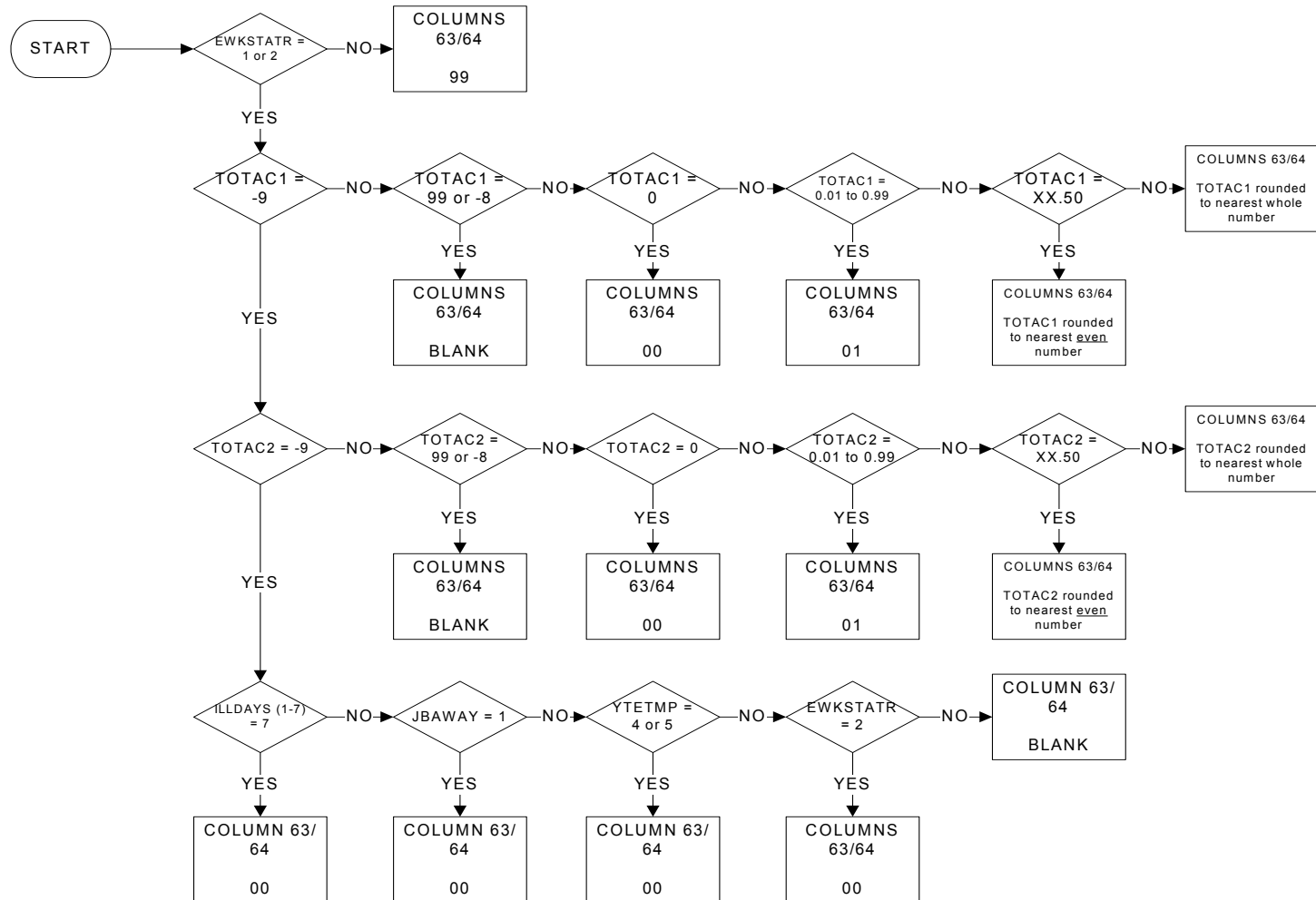

KEY

00 Person having a job or business and not having worked at all in the main activity during the reference week

01-98 Number of hours actually worked in the main job during the reference week

99 Not applicable (WSTATOR = 3-5 or 9)

Blank No answer

Notes

XX is a number in the range 01 to 97. Unbiased rounding is used; so instead of always rounding up, we will round up if the number is odd, and down if the number is even.

HWOVERP (EACTPOT): Paid overtime in the reference week in the main job

Column 65/66

PAGE 1 OF 1

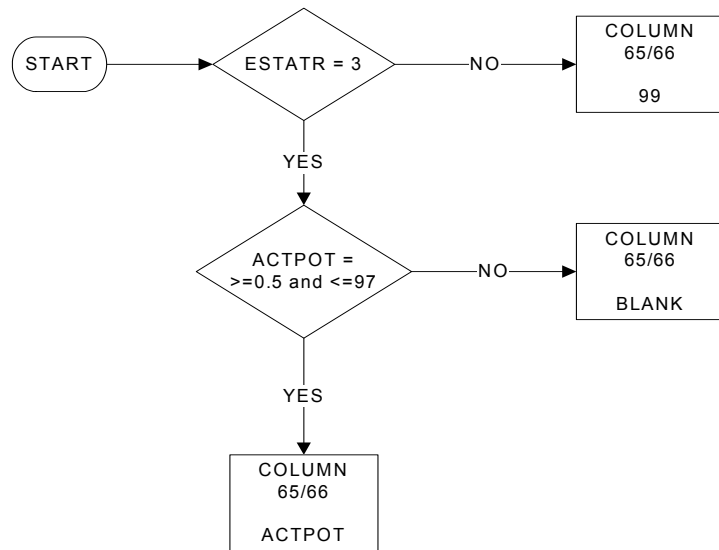

KEY

00-98	Number of paid overtime hours
99	Not applicable (STAPRO is not equal to 3)
BLANK	No answer

HWOVERPU (EACTUOT): Unpaid overtime in the reference week in the main job

Columns 67/68

PAGE 1 OF 1

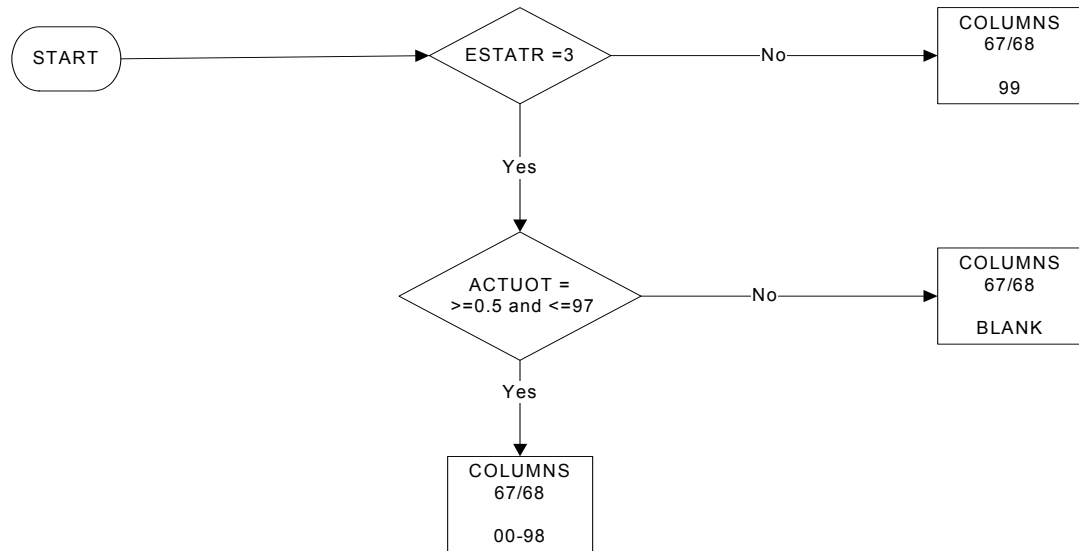

KEY	
00 - 98	Number of unpaid overtime hours
99	Not Applicable (STAPRO = 3)
BLANK	No answer

HOURREAS (EWHYDIFR): Main reason why hours actually worked differed from usual hours

Columns 69/70

PAGE 1 OF 2

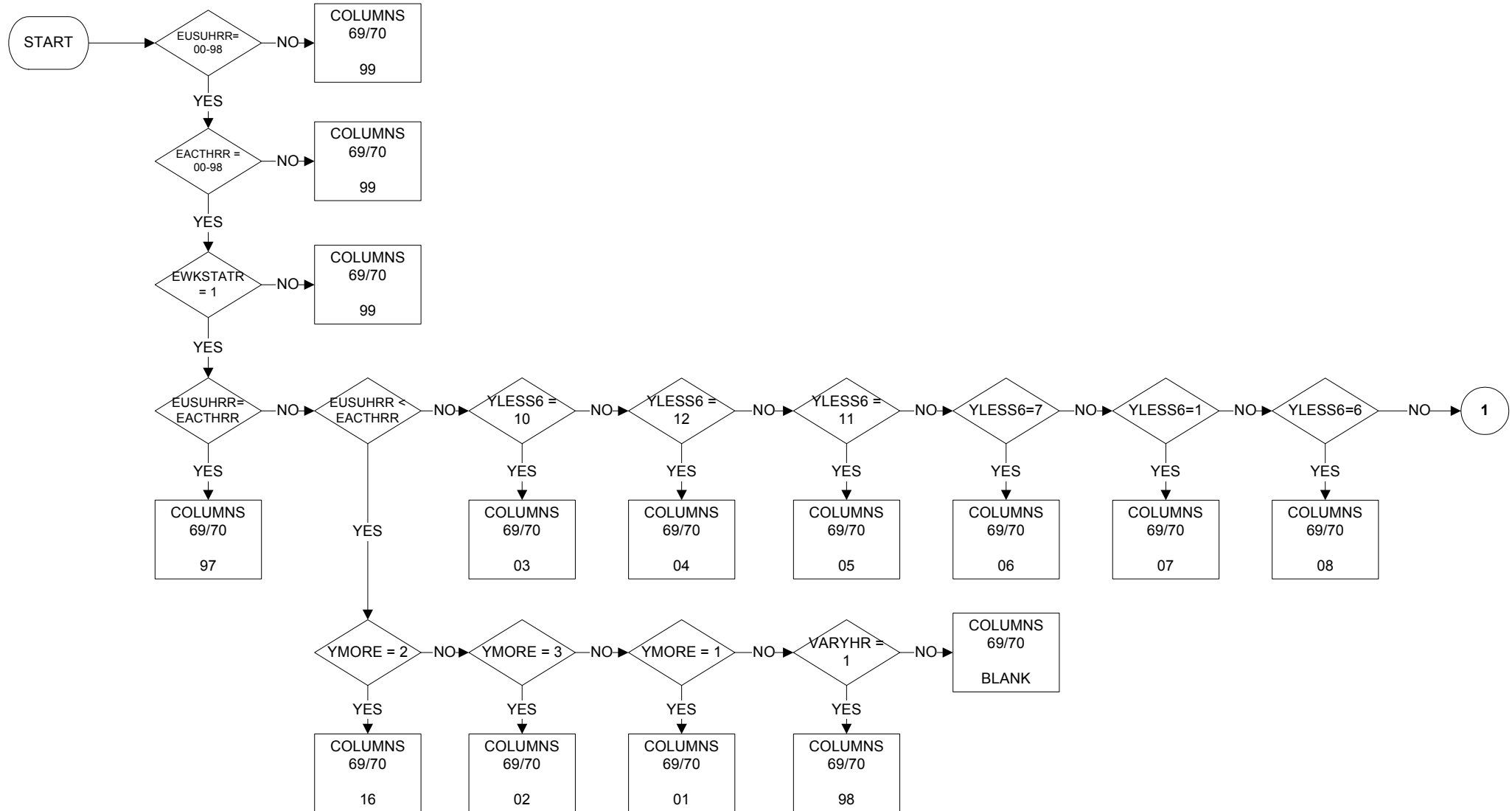

HOURREAS (EWHYDIFR): Main reason why hours actually worked differed from usual hours

Columns 69/70

PAGE 2 OF 2

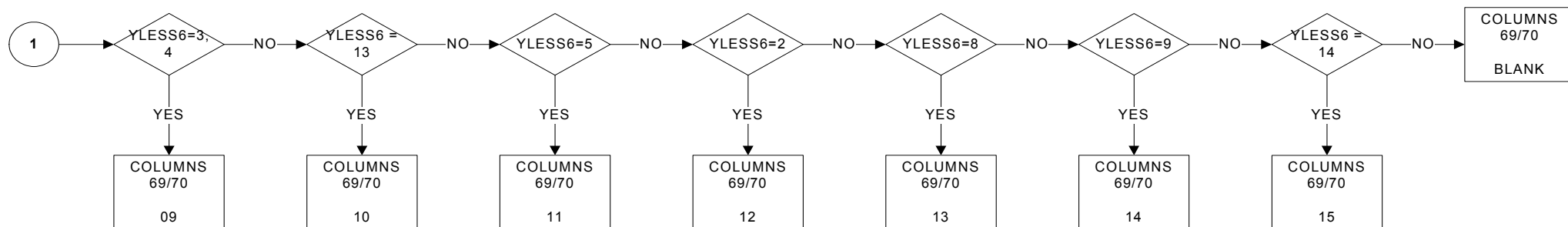

KEY

- 01 *Person has worked more than usual due to:*
- 01 Variable hours (e.g. flexible working hours)
- 16 Overtime
- 02 Other reasons
- Person has worked less than usual due to:*
- 03 Bad weather
- 04 Slack work for technical or economic reasons
- 05 Labour dispute
- 06 Education or training
- 07 Variable hours (e.g. flexible working hours)
- 08 Own illness, injury or temporary disability
- 09 Maternity or parental leave
- 10 Special leave for personal or family reasons
- 11 Annual holidays
- 12 Bank holidays
- 13 Start of/change in job during reference week
- 14 End of job without taking up a new one during reference week
- 15 Other reasons
- 97 Person having worked usual hours during the reference week (HWUSUAL = HWACTUAL = 01-98)
- 98 Person whose hours vary considerably from week to week or month to month and who did not state a reason for a divergence between the actual and usual hours (HWUSUAL = 00 & HOURREAS # 01-16)
- 99 Not applicable (WSTATOR = 2-5,9 or HWUSUAL = blank or HWACTUAL = blank)
- BLANK No answer

WISHMORE (EMHRSR): Wish to work usually more than the current numbers of hours

Column 71

PAGE 1 OF 1

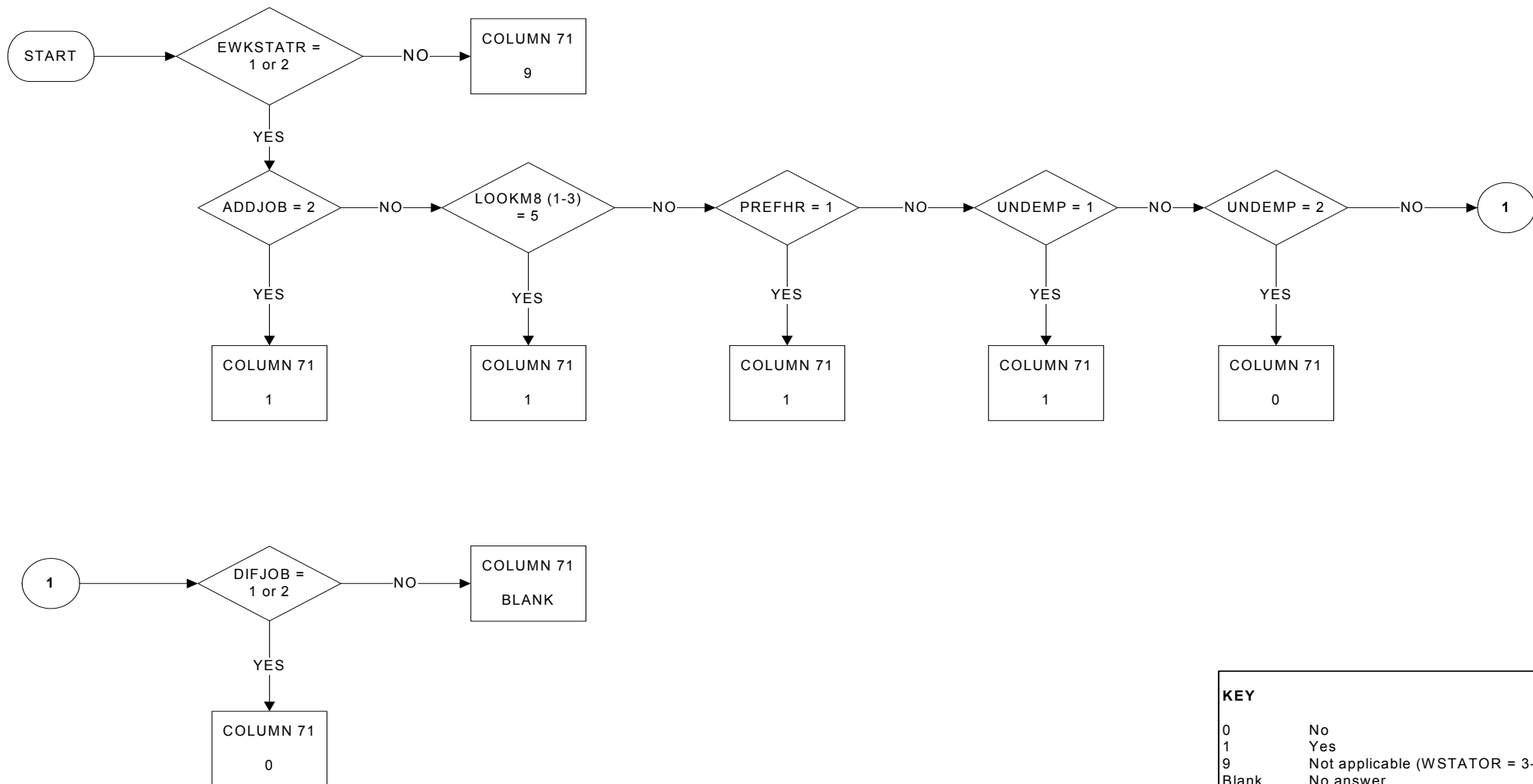

KEY

0	No
1	Yes
9	Not applicable (WSTATOR = 3-5, 9)
Blank	No answer

WAYMORE (EWAYHRS): Way that a person can work more hours

Column 72

PAGE 1 OF 1

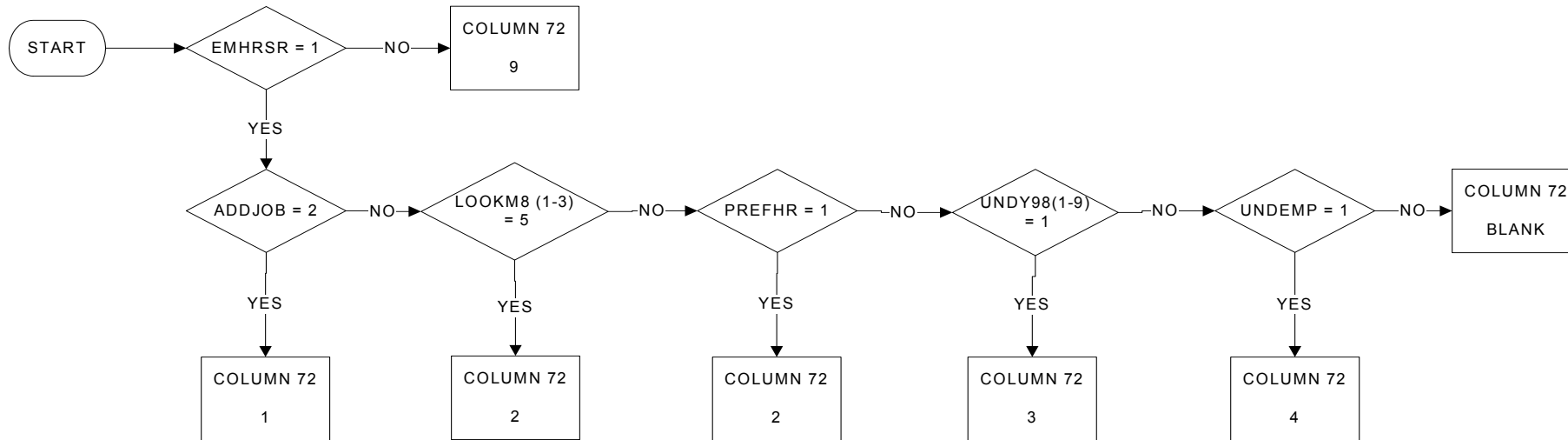

KEY

- 1 Through an additional job
- 2 Through a job working more hours than the present job
- 3 Only within the present job
- 4 In any of the above ways
- 9 Not applicable (WISHMORE ? 1)
- BLANK No Answer

HWWISH (ENUMHRSR): Number of hours would like to work in total

Columns 73/74

PAGE 1 OF 1

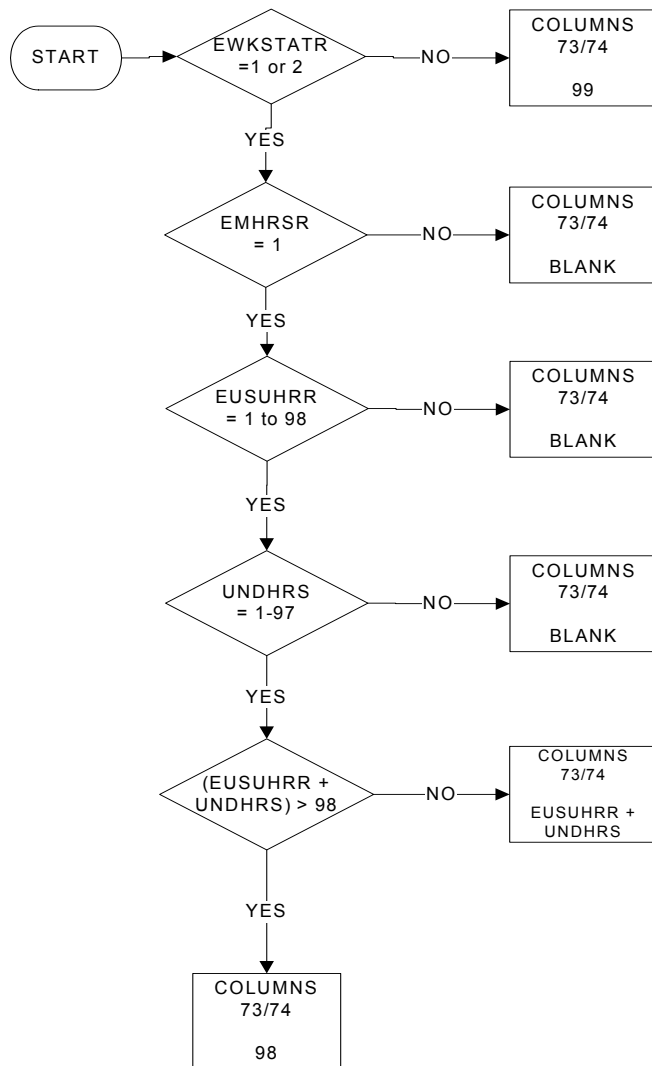

KEY	
01 - 98	Number of hours wished to work in total
99	Not applicable (WSTATOR = 3-5,9)
BLANK	No answer

HOMEWK (EHOMER): Working at home in the first job

Column 75
PAGE 1 OF 1

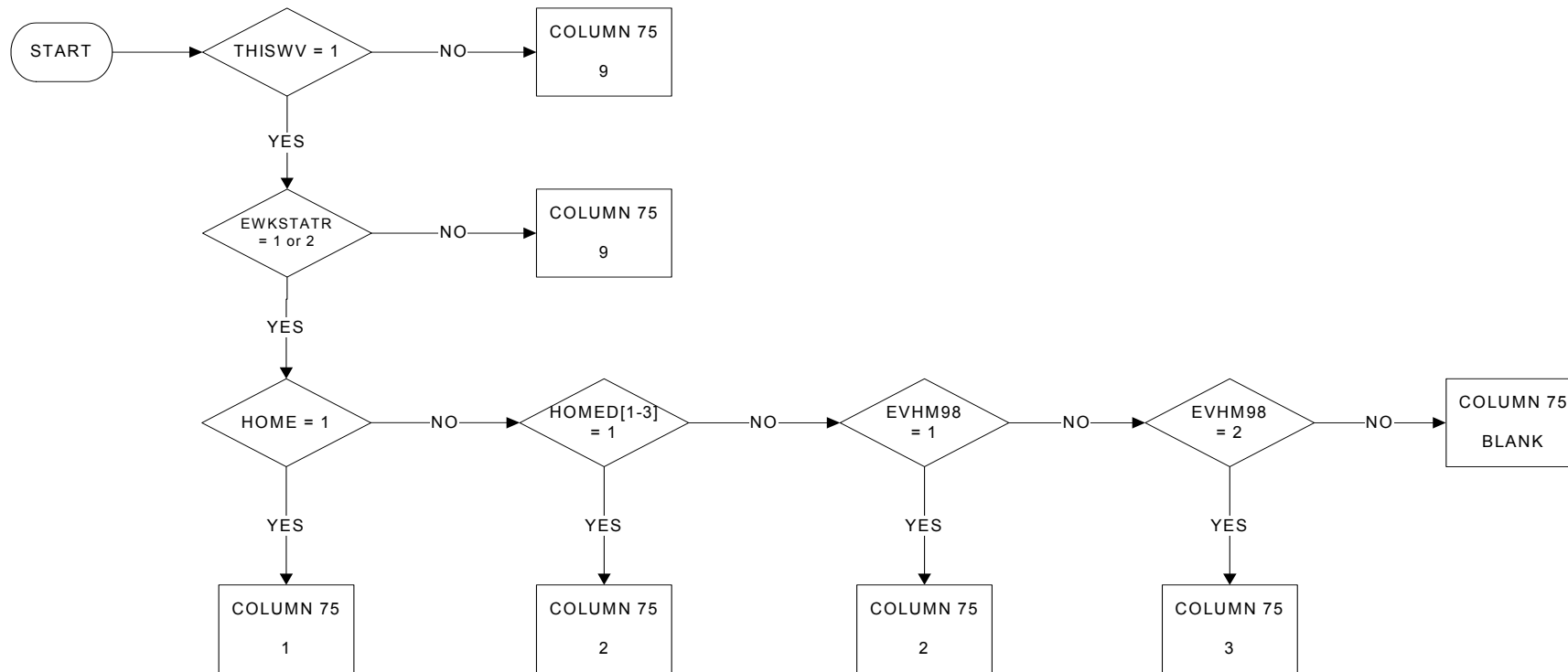

KEY	
1	Person usually works at home
2	Person sometimes works at home
3	Person never works at home
9	Not applicable (WSTATOR = 3-5 or 9)
Blank	No Answer

LOOKOJ (EADDWKR): Looking for another job

Column 76

PAGE 1 OF 1

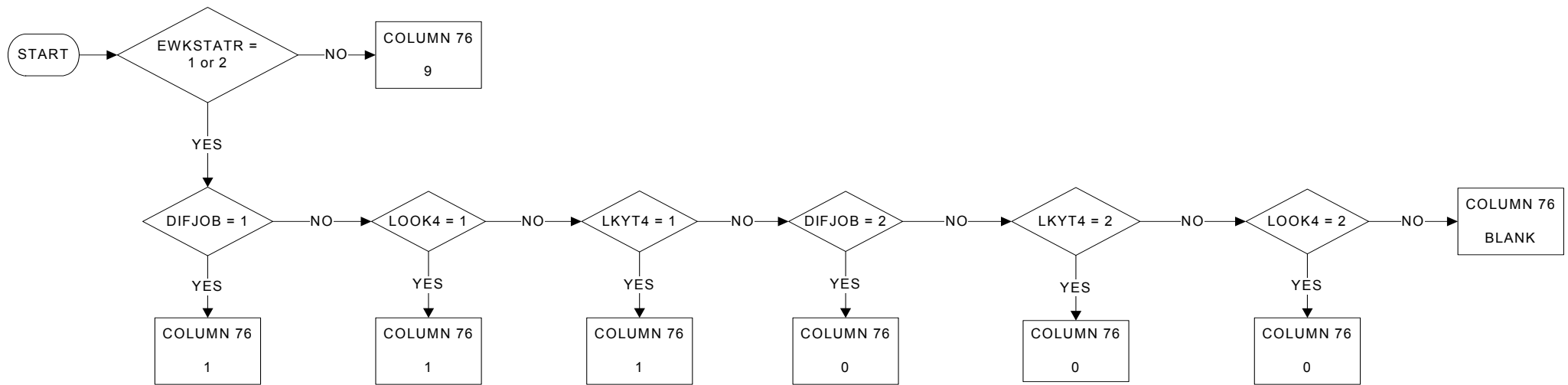

KEY	
0	Person is not looking for another job
1	Person is looking for another job
9	Not applicable (WSTATOR = 3-5, 9)
BLANK	No answer

LOOKREAS (EADDREA): Reasons for looking for another job

Column 77
PAGE 1 OF 1

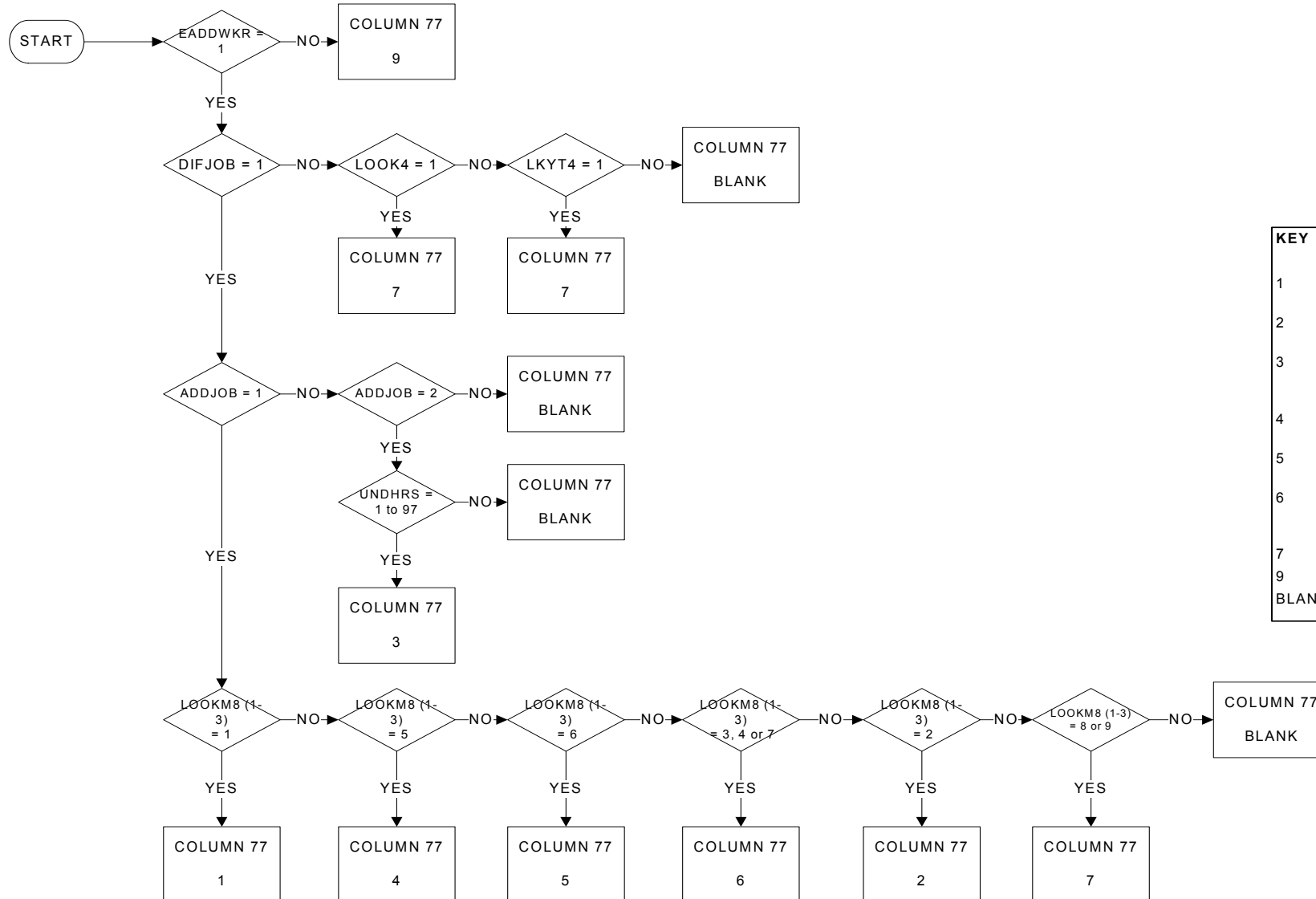

KEY	
1	Risk or certainty of loss or termination of present job
2	Actual job is considered as a transitional job
3	Seeking an additional job to add more hours to those worked in present job
4	Seeking a job with more hours worked than in present job
5	Seeking a job with less hours worked than in present job
6	Wish to have better working conditions (e.g. pay, working or travel time, quality of work)
7	Other reasons
9	Not applicable (LOOKOJ ? 1)
BLANK	No answer

EXIST2J (ESECJOBR): Existence of more than one job or business

Column 78

PAGE 1 OF 1

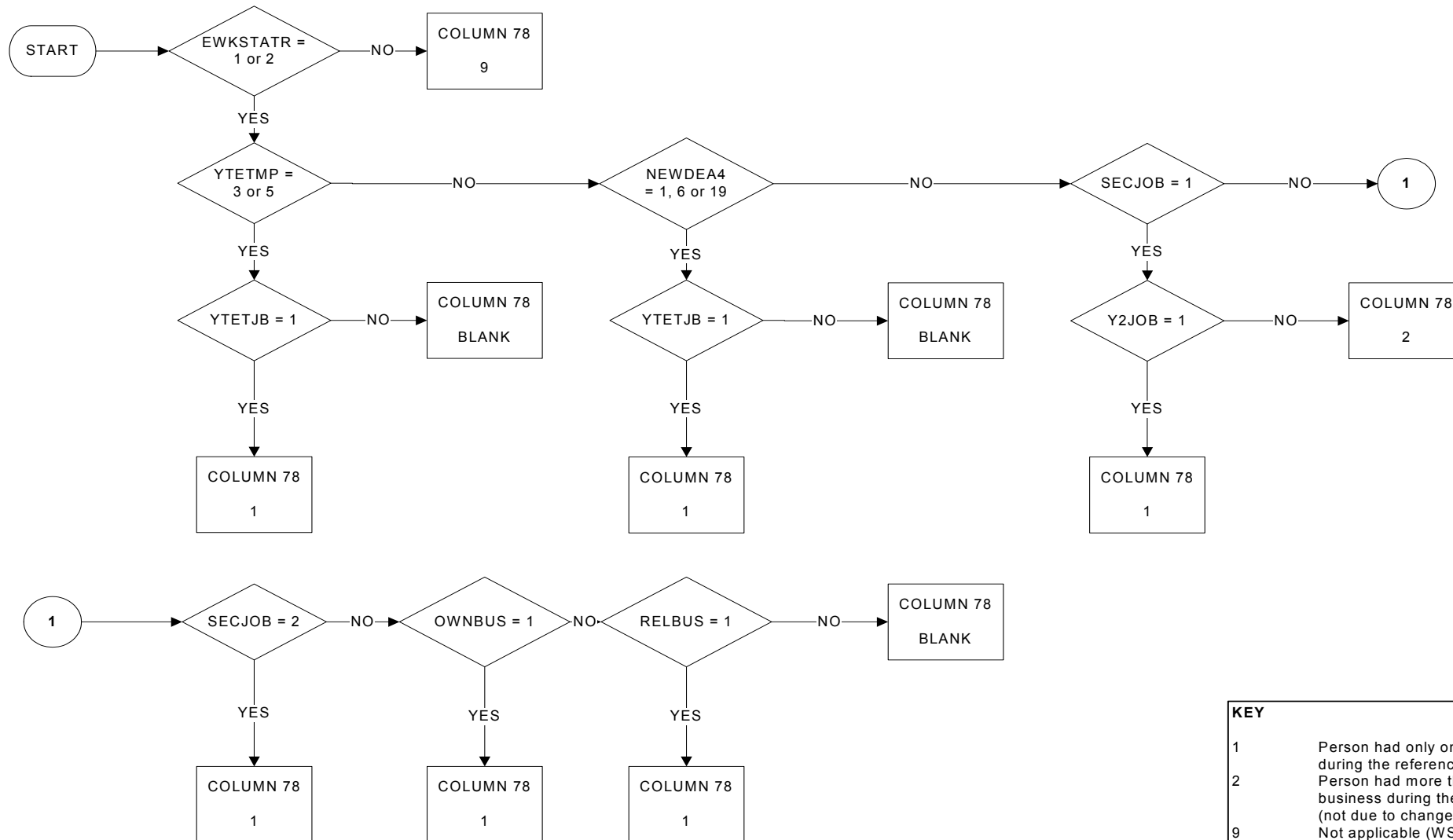

KEY	
1	Person had only one job or business during the reference week
2	Person had more than one job or business during the reference week (not due to change of job or business)
9	Not applicable (WSTATOR = 3-5 or 9)
BLANK	No answer

STAPRO2J (ESTAT2R): Professional status in second job

Column 79

PAGE 1 OF 1

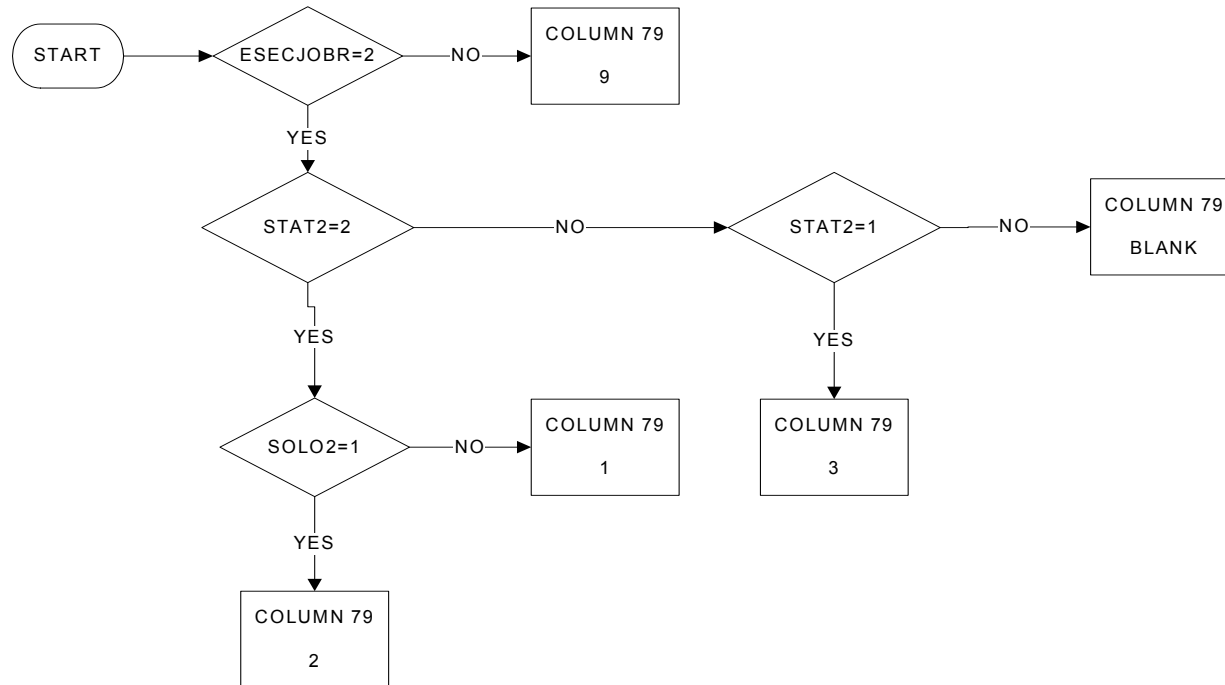

KEY	
1	Self-employed with employees
2	Self-employed without employees
3	Employee
4	Family worker
9	Not applicable (EXIST2J = 1, 9, BLANK)
BLANK	No answer

NACE2J2D (ENACE208): Economic activity of the local unit (in the second job)

Column 80/81

PAGE 1 OF 1

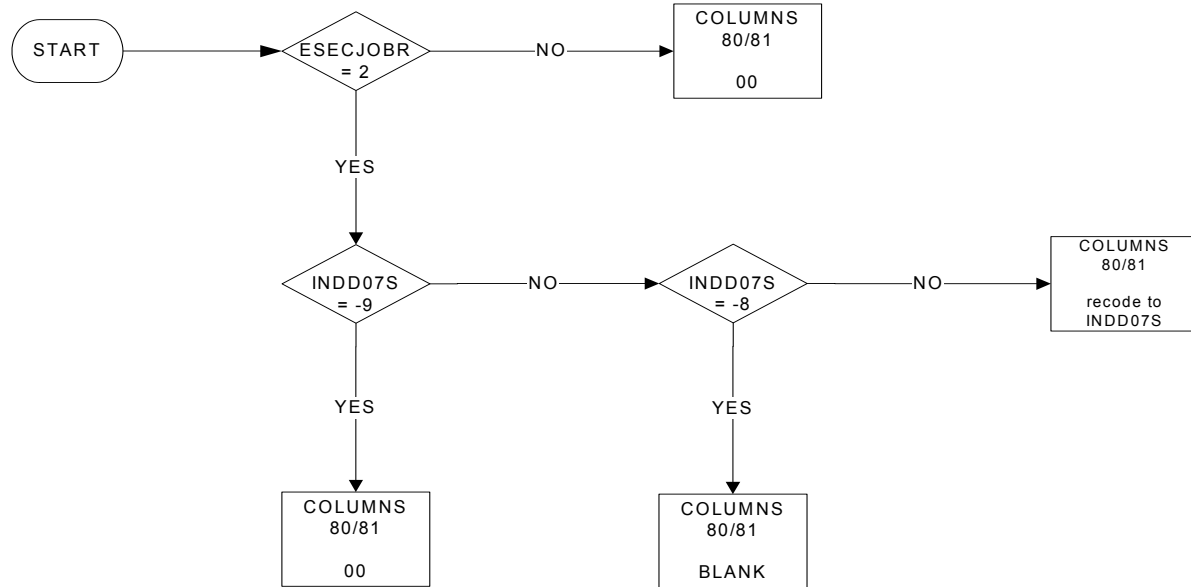

KEY	
	Nace Rev. 2
00	Not applicable (EXIST2J = 1, 9, BLANK)
Blank	No answer

HWACTUA2 (EACTHR2R): Number of hours actually worked in second job

Columns 82/83
PAGE 1 OF 1

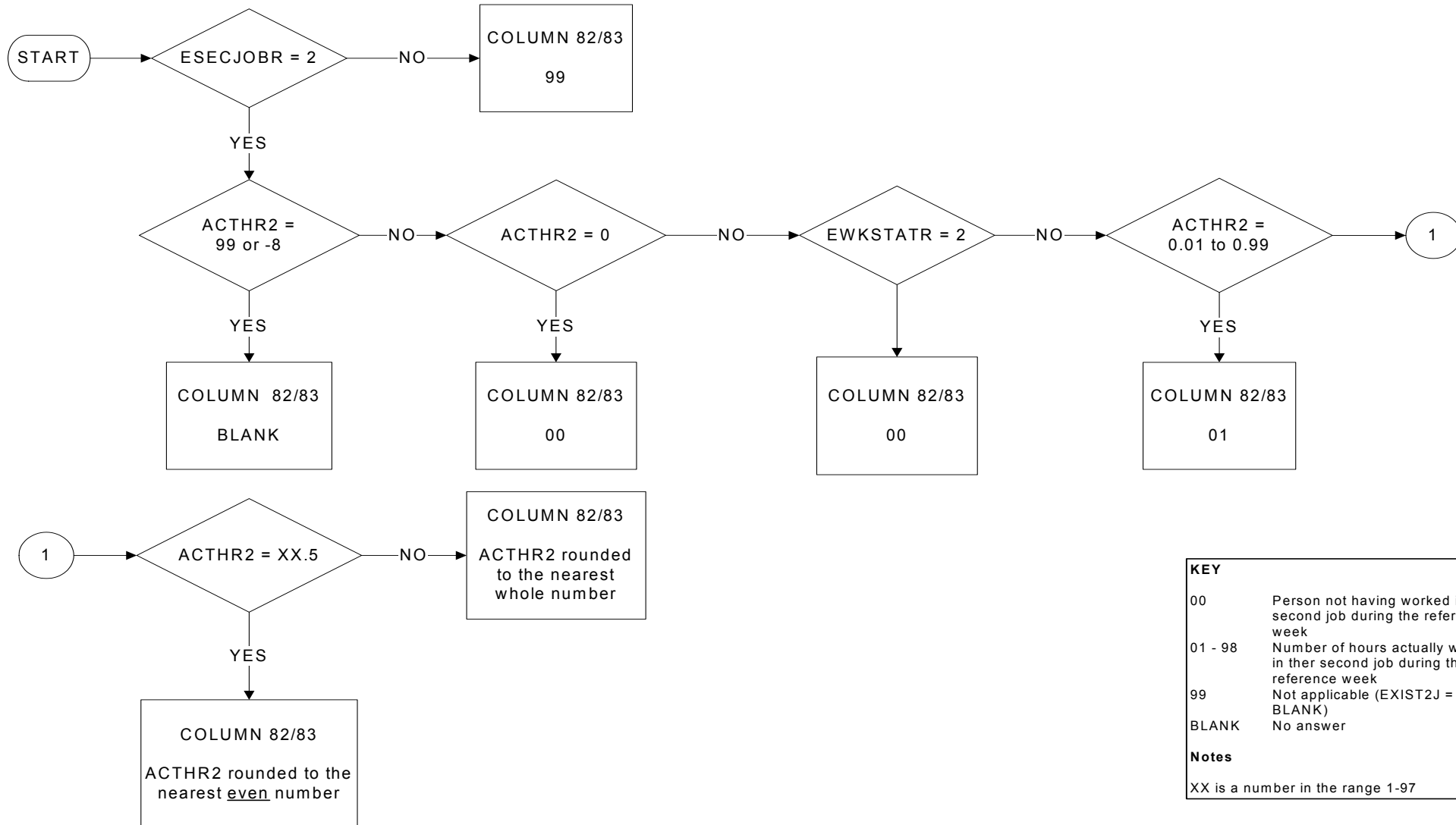

KEY	
00	Person not having worked in the second job during the reference week
01 - 98	Number of hours actually worked in their second job during the reference week
99	Not applicable (EXIST2J = 1, 9, BLANK)
BLANK	No answer
Notes	
XX is a number in the range 1-97	

EXISTPR (EEVWKR): Existence of previous employment experience

Column 84
PAGE 1 OF 1

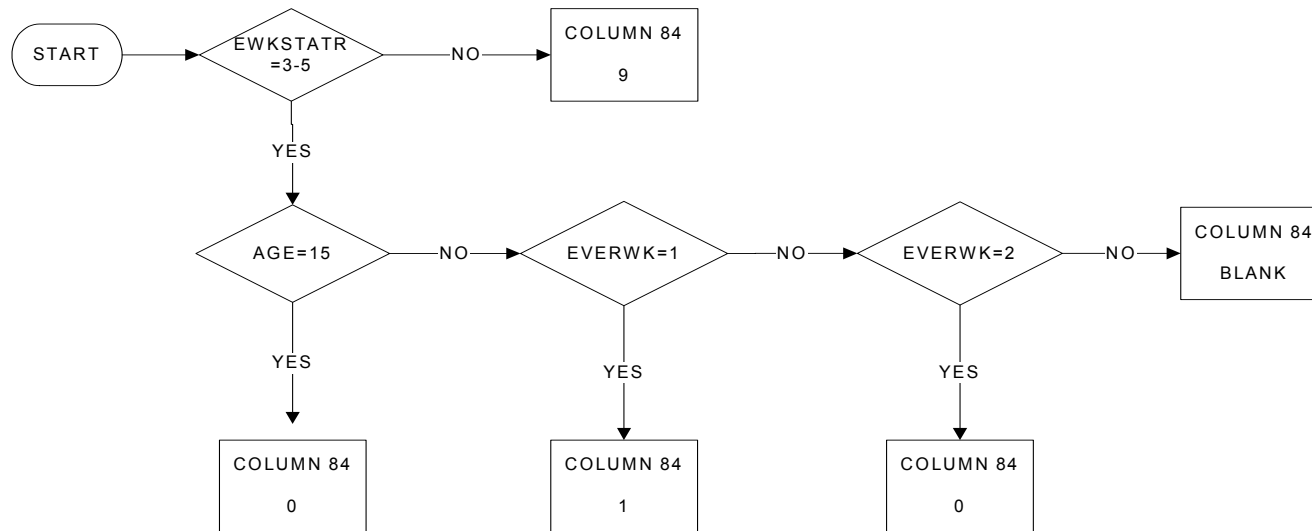

KEY	
0	Person has never been in employment (purely occasional work, such as vacation work, compulsory military or community service are not to be considered as employment)
1	Person has already been in employment (purely occasional work, such as vacation work, compulsory military or community service are not to be considered as employment)
9	Not applicable (WSTATOR = 1, 2 or 9)
BLANK	No answer

YEARPR (EYRLASTR): Year in which person last worked

Columns 85/88

PAGE 1 OF 1

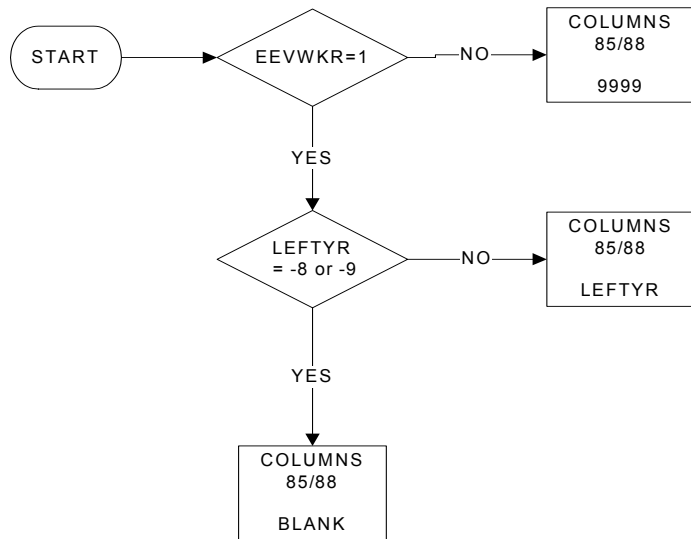

KEY	
	Enter the 4 digits of the year in which person last worked
9999	Not applicable (EXISTPR = 0, 9, BLANK)
BLANK	No answer

MONTHPR (EMNLASTR): Month in which person last worked

Columns 89/90

PAGE 1 OF 1

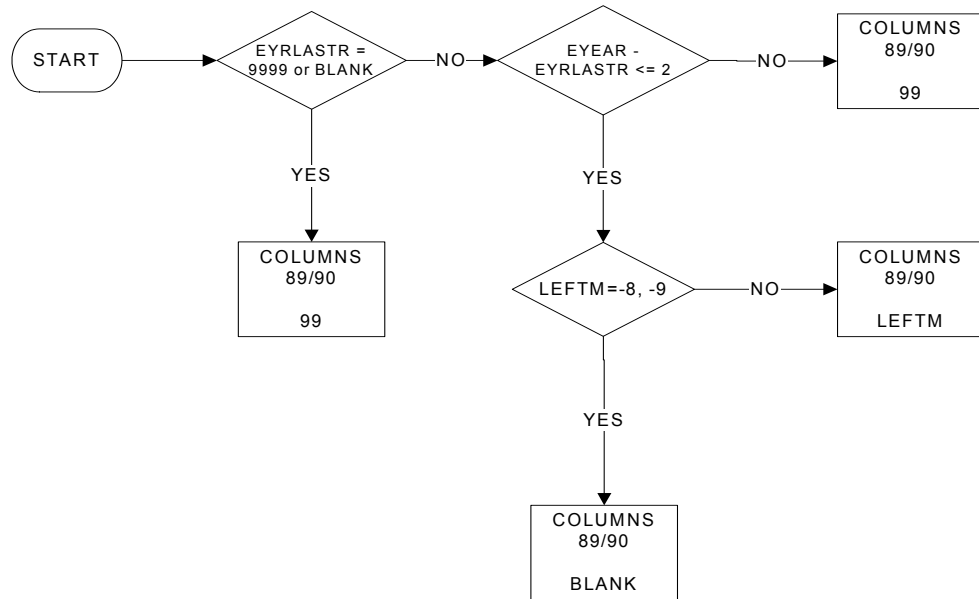

KEY

01-12	Enter the number of the month in which person last worked
99	Not applicable (YEARPR = 9999, BLANK or REFYEAR-YEARPR>2)
BLANK	No answer

LEAVREAS (EWHYLFTR): Main reason for leaving last job or business

Column 91/92

PAGE 1 OF 1

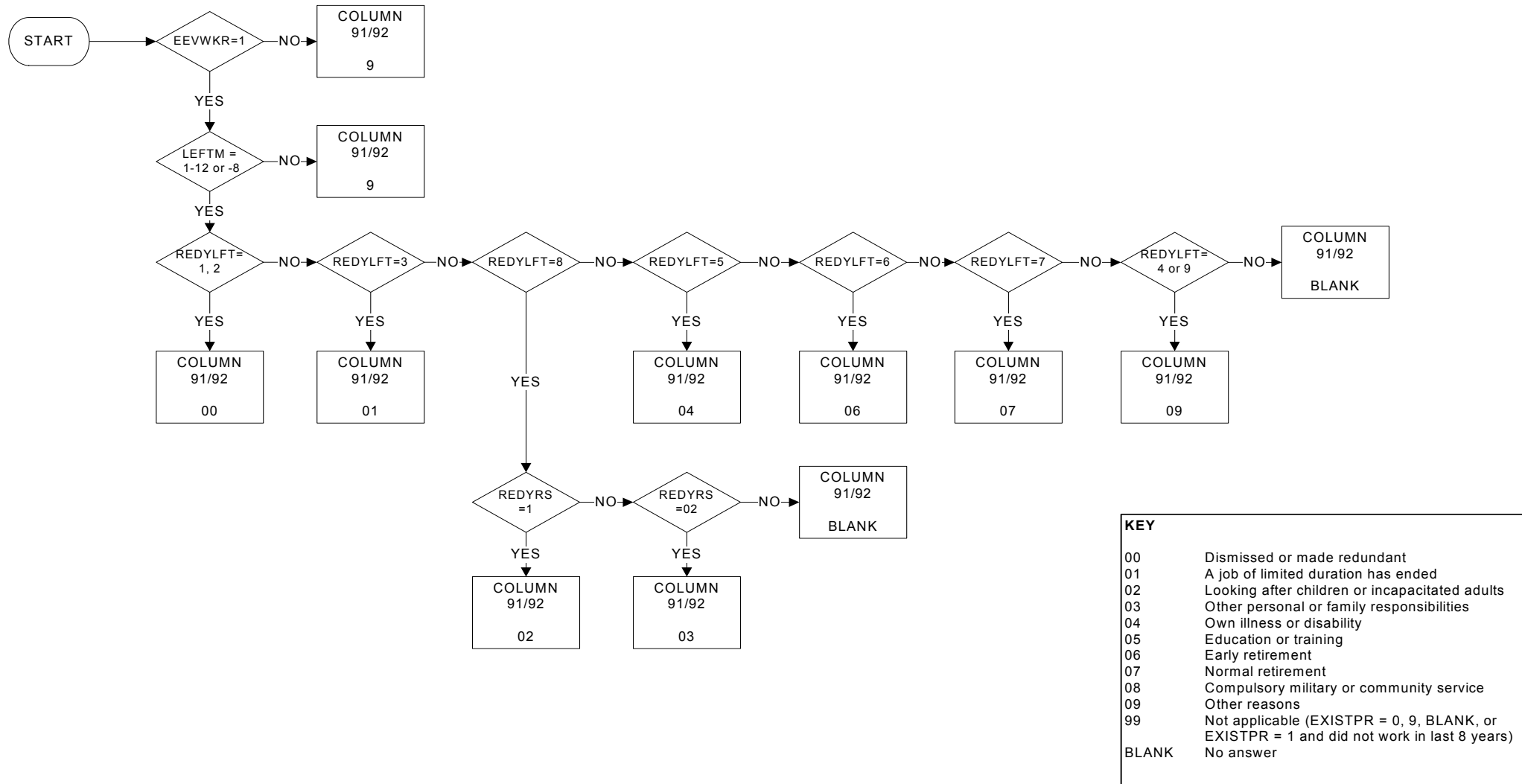

KEY	
00	Dismissed or made redundant
01	A job of limited duration has ended
02	Looking after children or incapacitated adults
03	Other personal or family responsibilities
04	Own illness or disability
05	Education or training
06	Early retirement
07	Normal retirement
08	Compulsory military or community service
09	Other reasons
99	Not applicable (EXISTPR = 0, 9, BLANK, or EXISTPR = 1 and did not work in last 8 years)
BLANK	No answer

STAPROPR (ESTATLR): Professional status in last job

Column 93
PAGE 1 OF 1

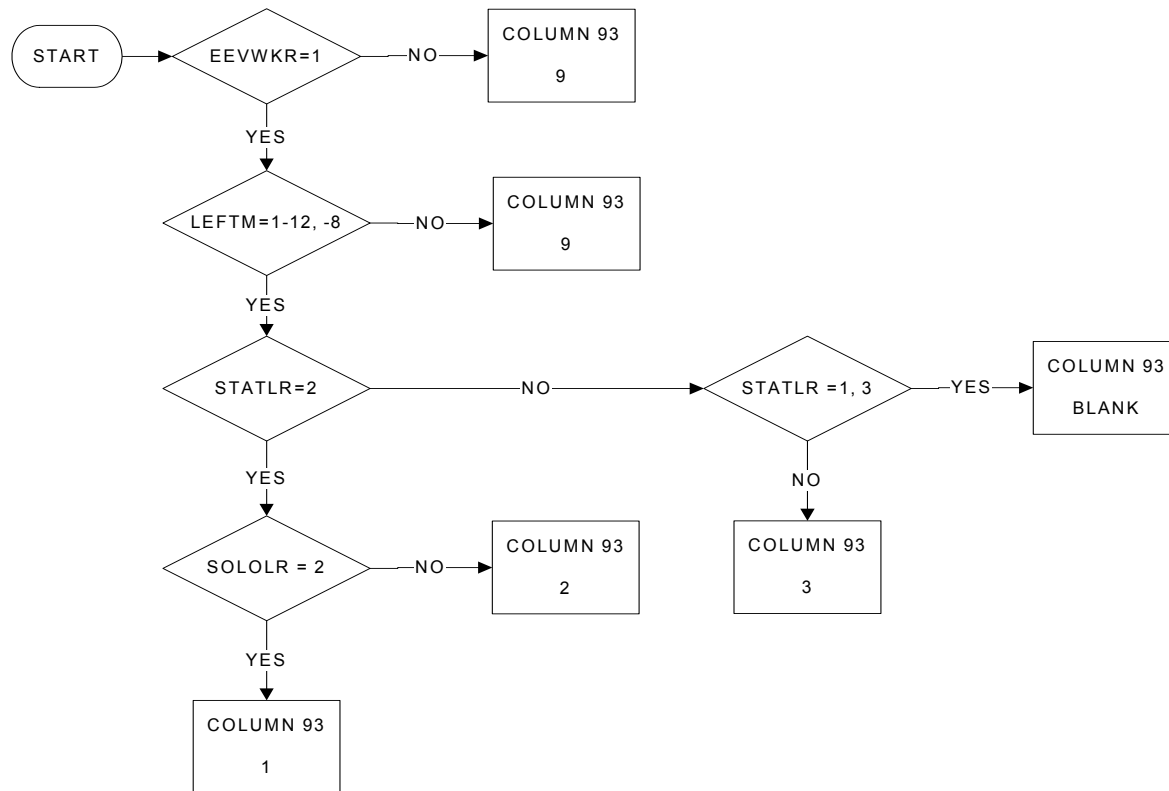

KEY	
1	Self-employed with employees
2	Self-employed without employees
3	Employee
4	Family worker
9	Not applicable (EXISTPR = 0, 9, BLANK, or EXISTPR = 1 and did not work in last 8 years)
BLANK	No answer

NACEPR2D (ENACEL08): Economic activity of the local unit in which person last worked

Column 94/95

PAGE 1 OF 1

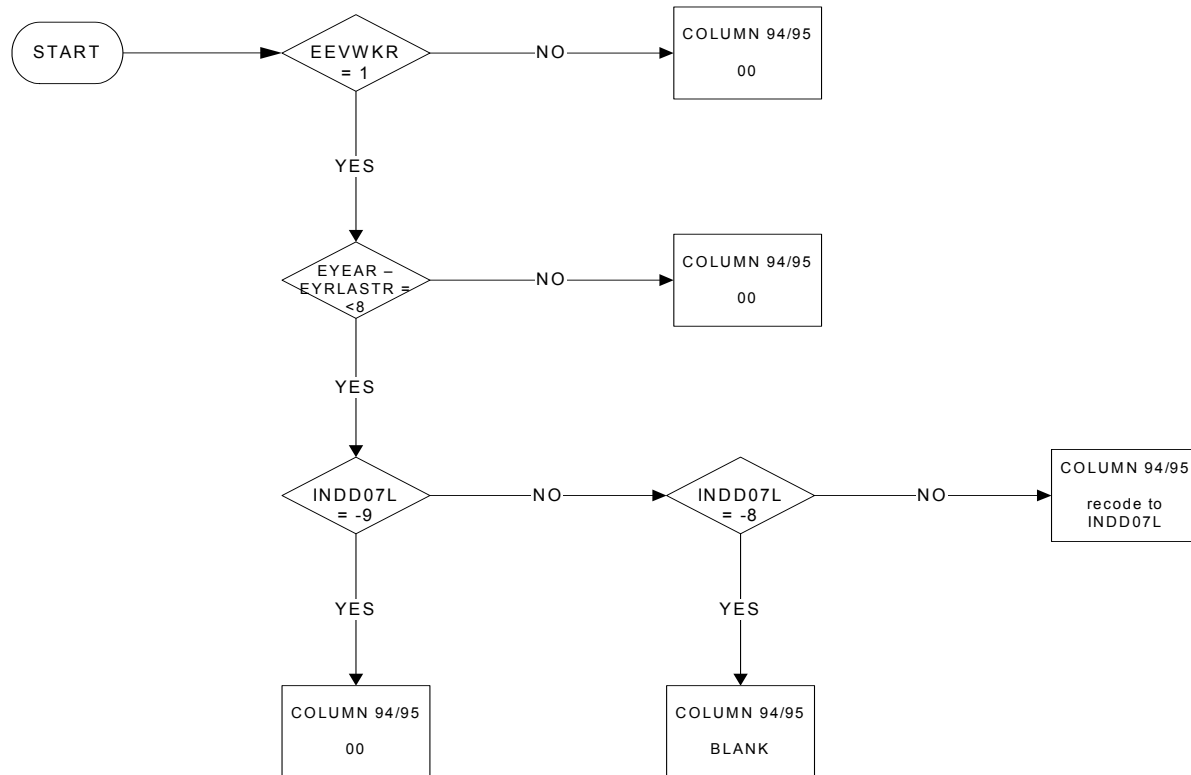

KEY	
	NACE Rev. 2
00	Not applicable (col 84 = 0, 9, BLANK or col 84 = 1 and did not work in last eight years)
Blank	No answer

ISCOPR3D (EISCOLR): Occupation of last job

Columns 96/98

PAGE 1 OF 1

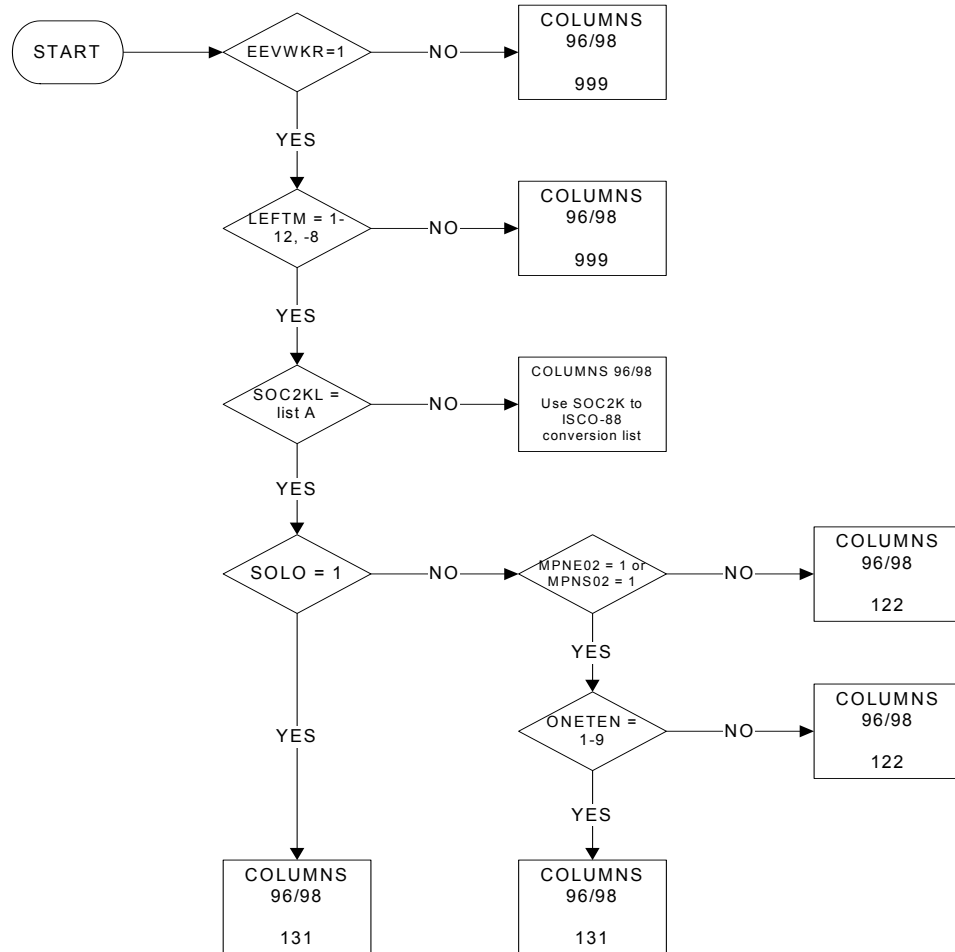

KEY

999 Not applicable (EXISTPR = 0, 9, BLANK or EXISTPR = 1 and did not work in last 8 years)

BLANK No answer

Notes

List A=
1121, 1122, 1151, 1222, 1231, 1161, 1162, 1226, 1163, 1232, 1182, 1183, 1225, 1235, 1239, 1185, 1233, 1211, 1212, 1219, 1221, 1223, 1224

SEEKWORK (ELOOKR): Seeking employment during previous four weeks

Column 99
PAGE 1 OF 1

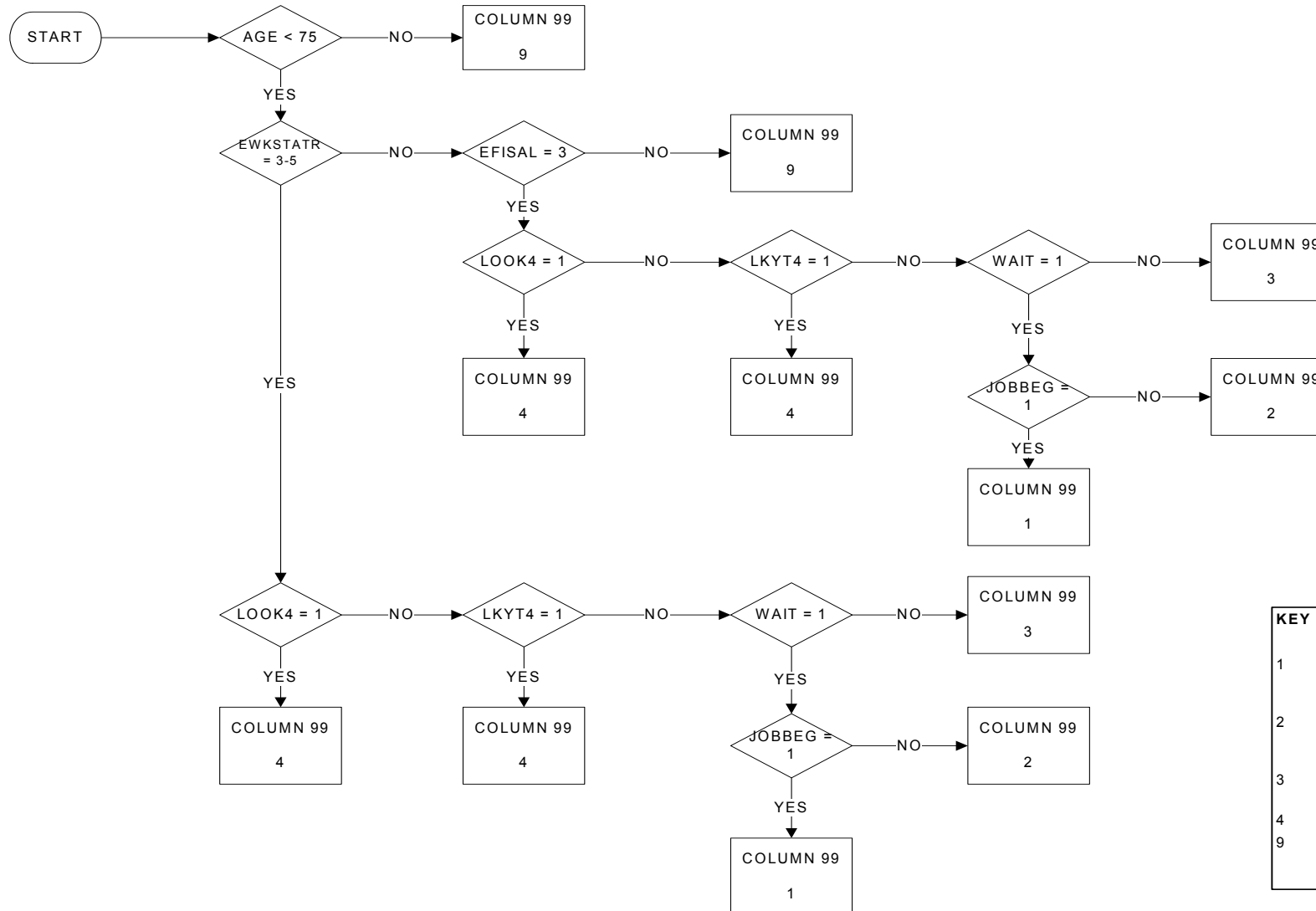

KEY	
1	Person has already found a job which will start within a period of at most 3 months
2	Person has already found a job which will start in more than 3 months and is not seeking employment
3	Person is not seeking employment and has not found any job to start later
4	Person is seeking employment
9	Not applicable (WSTATOR = 1, 2 or 9 and SIGNISAL ? 3) or Age = 75

SEEKWORK (ENOLWM): Reasons for not seeking employment

Column 100
PAGE 1 OF 1

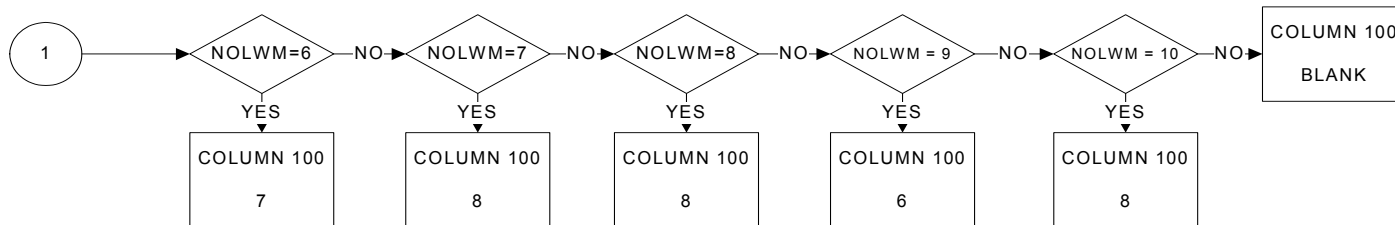
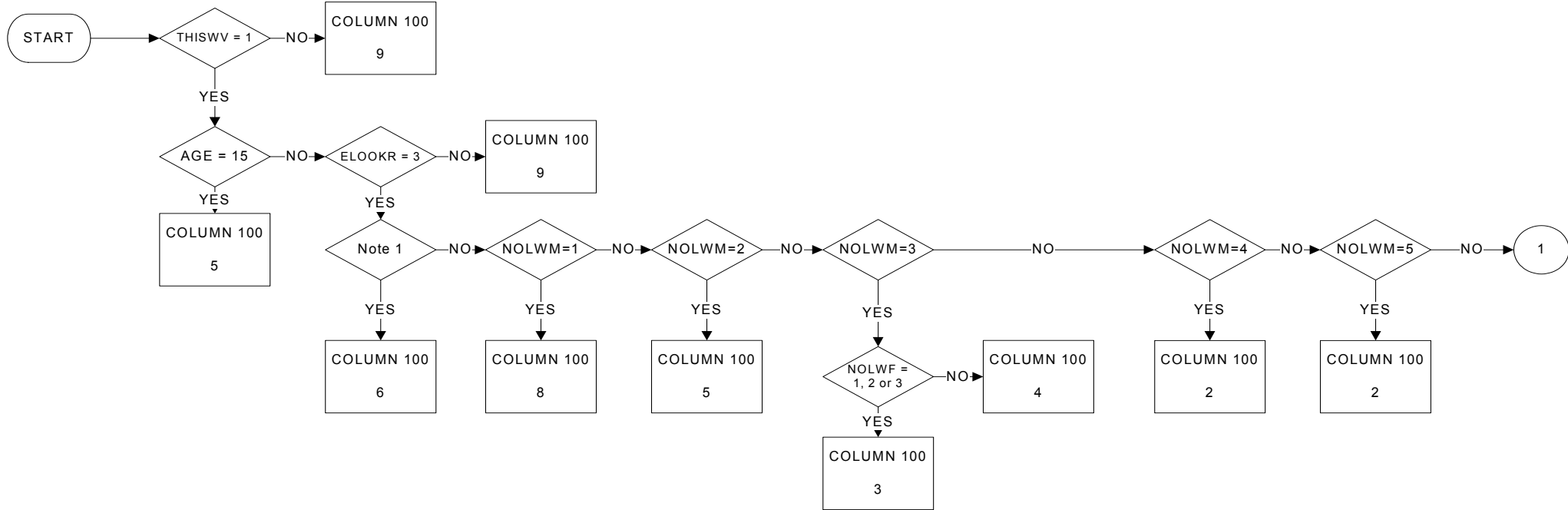

KEY	
1	Awaiting recall to work (person on lay-off)
2	Because of own illness or disability looking after children or incapacitated adults
3	Because of other personal or family responsibilities
4	Because of education or training
5	Because of retirement
6	Because of belief that no work is available
7	Because of other reasons
8	Not applicable (SEEKWORK ? 3)
9	No answer
BLANK	No answer

Note 1:
(SEX=1 & AGE>=70) or (SEX=2 & AGE>=65)

SEEKTYPE (ETYMP SR): Type of employment sought (or found)

Column 101

PAGE 1 OF 2

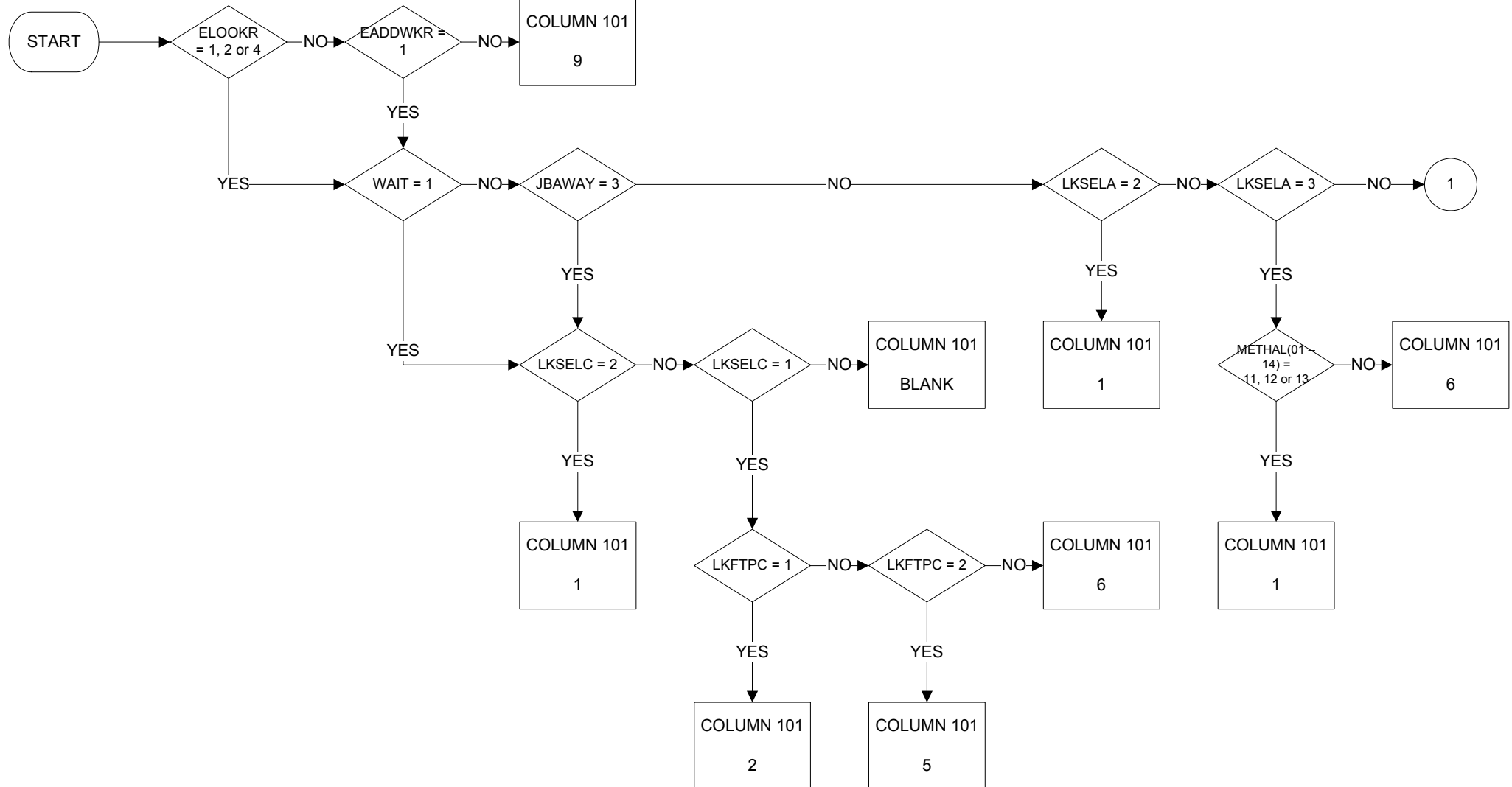

SEEKTYPE (ETYMP SR): Type of employment sought (or found)

Column 101

PAGE 2 OF 2

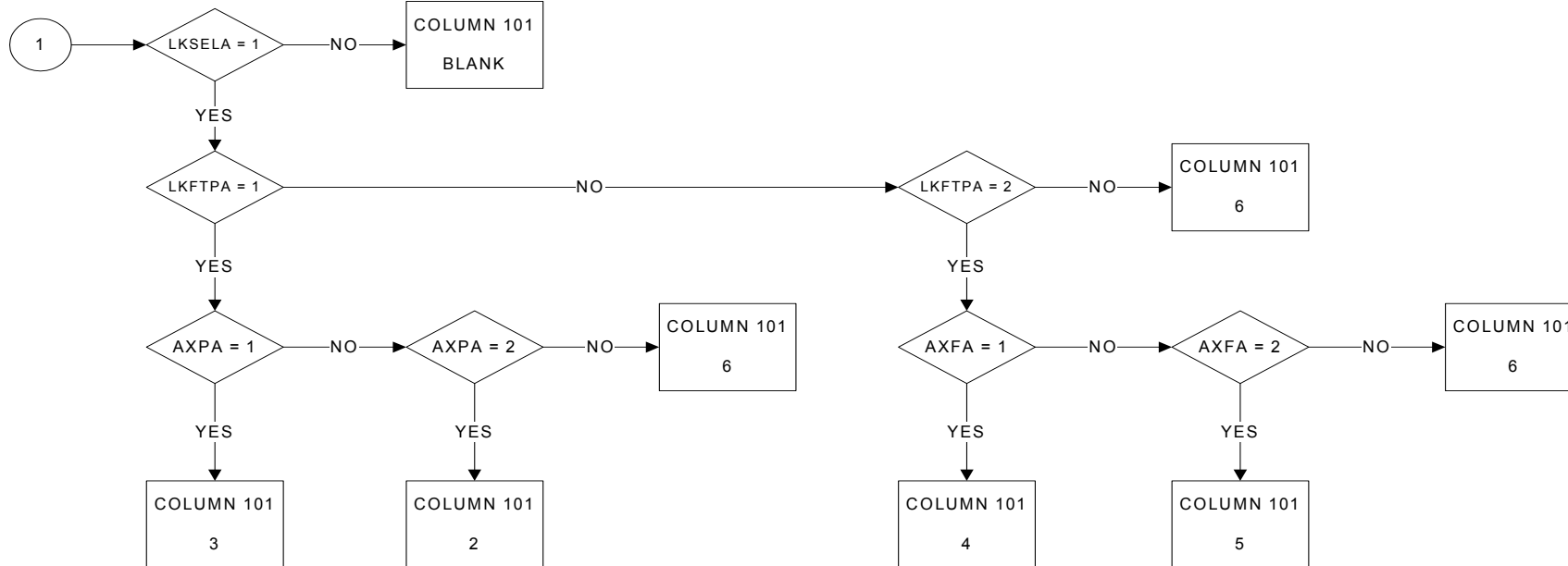

KEY	
1	As self-employed
	As Employee:
2	Only full time is looked for (or has already been found)
3	Full time job is sought, but if not available, part time job will be accepted
4	Part time job is sought, but if not available, full time job will be accepted
5	Only part time job is looked for (or has already been found)
6	Person did not state whether full time or part time job is looked for (or has already been found)
9	Not applicable (SEEKWORK ? 1, 2, 4 and LOOKOJ ? 1)
BLANK	No Answer

SEEKDUR (ELKTIMR): Duration of search for employment

Column 102
PAGE 1 OF 2

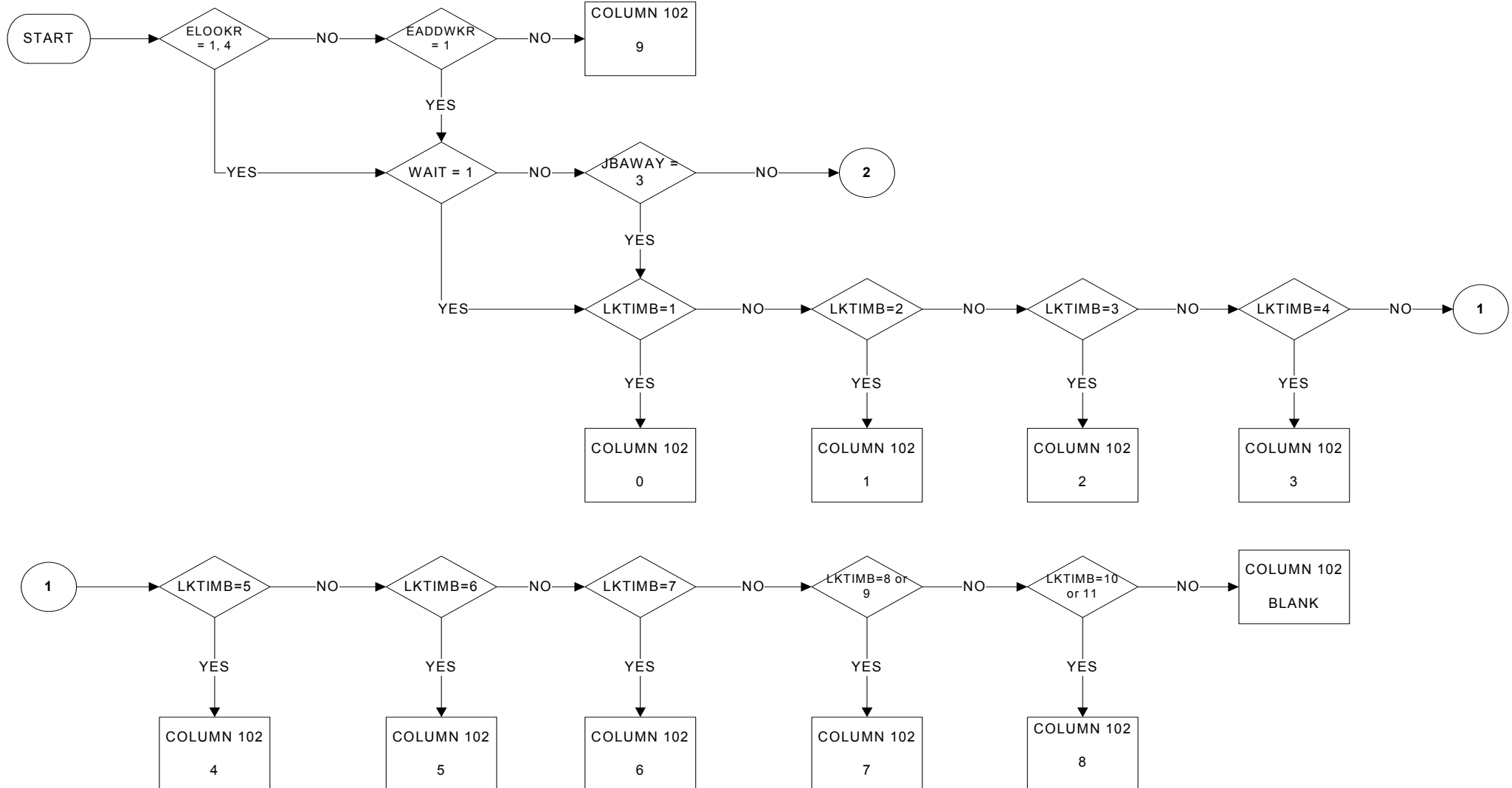

SEEKDUR (ELKTIMR): Duration of search for employment

Column 102
PAGE 2 OF 2

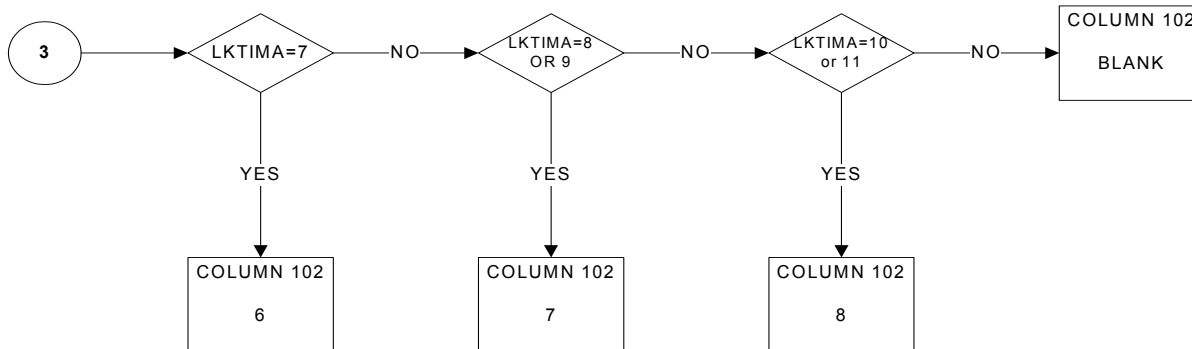
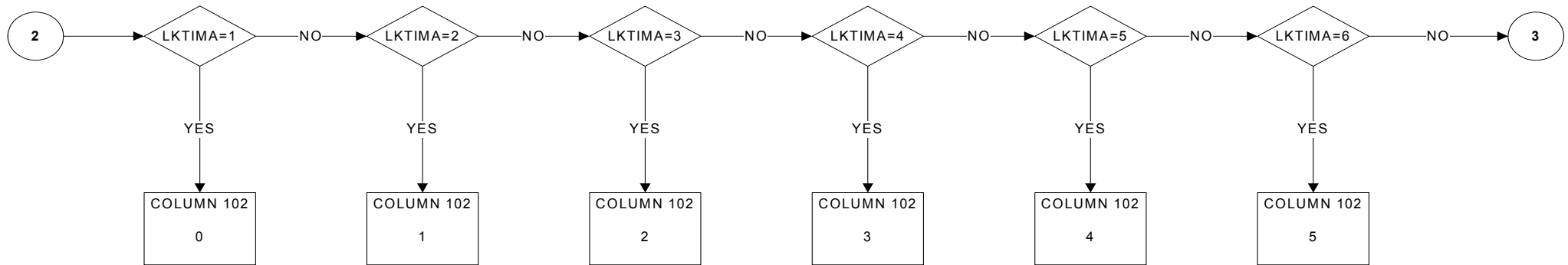

KEY	
0	Search not yet started
1	Less than 1 month
2	1-2 months
3	3-5 months
4	6-11 months
5	12-17 months
6	18-23 months
7	24-47 months
8	4 years or longer
9	Not applicable (SEEKWORK ? 1, 4 and LOOKOJ ? 1)
BLANK	No answer

METHODA (EMETH1R): Contacted public employment office to find work

Column 103
PAGE 1 OF 1

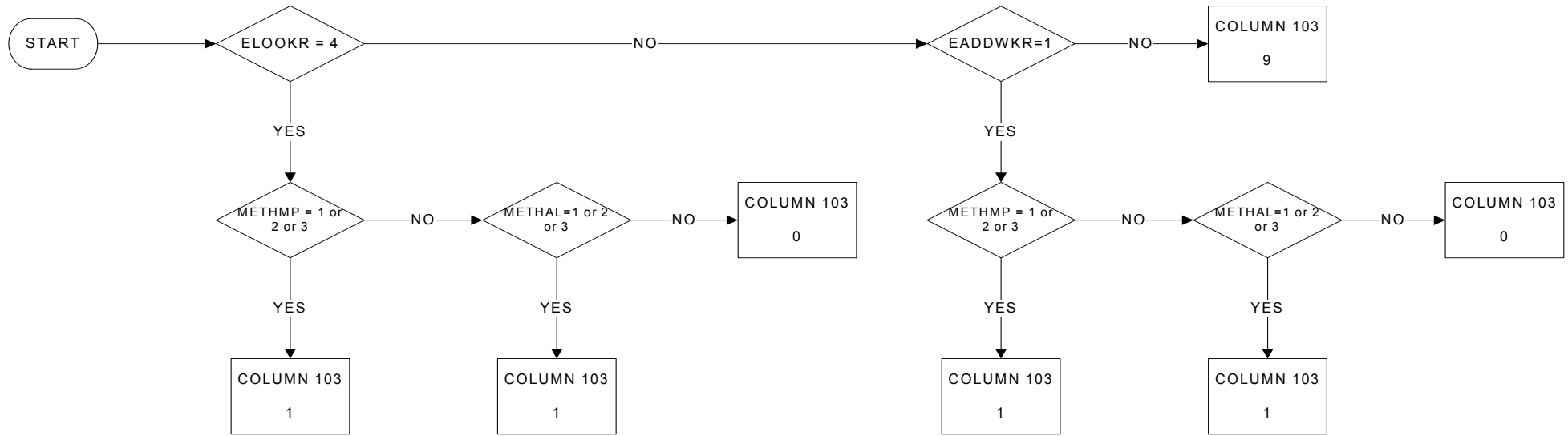

KEY	
0	No
1	Yes
9	Not applicable (SEEKWORK ? 4 and LOOKOJ ? 1)

METHODB (EMETH2R): Contacted private employment agency to find work

Column 104
PAGE 1 OF 1

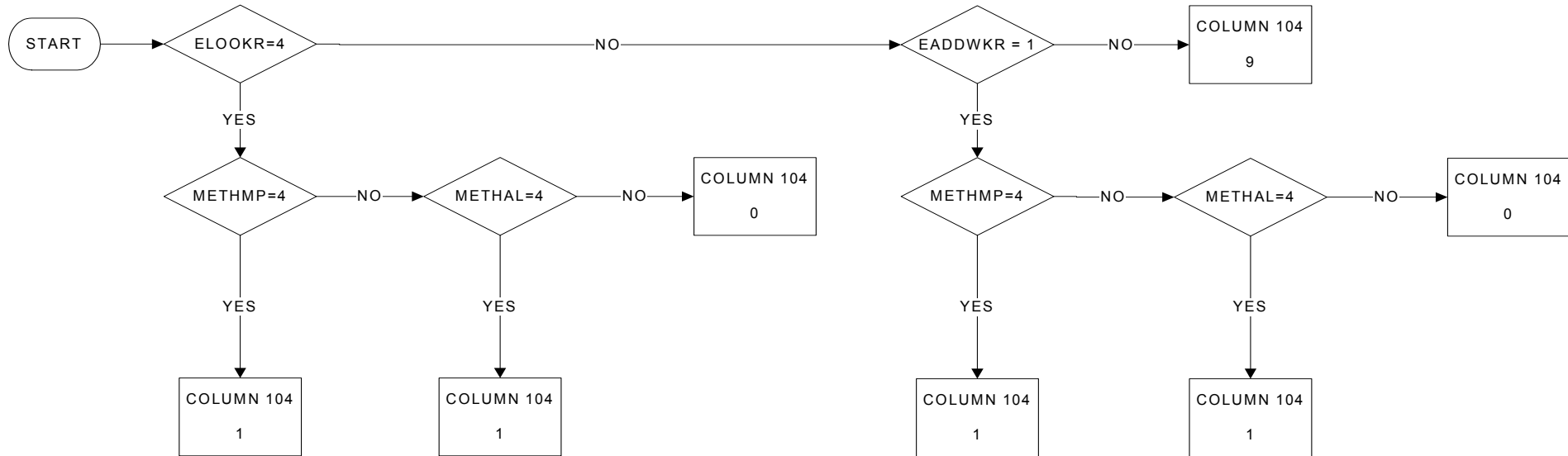

KEY	
0	No
1	Yes
9	Not applicable (SEEKWORK ? 4 and LOOKOJ ? 1)

METHODC (EMETH3R): Applied to employers directly

Column 105
PAGE 1 OF 1

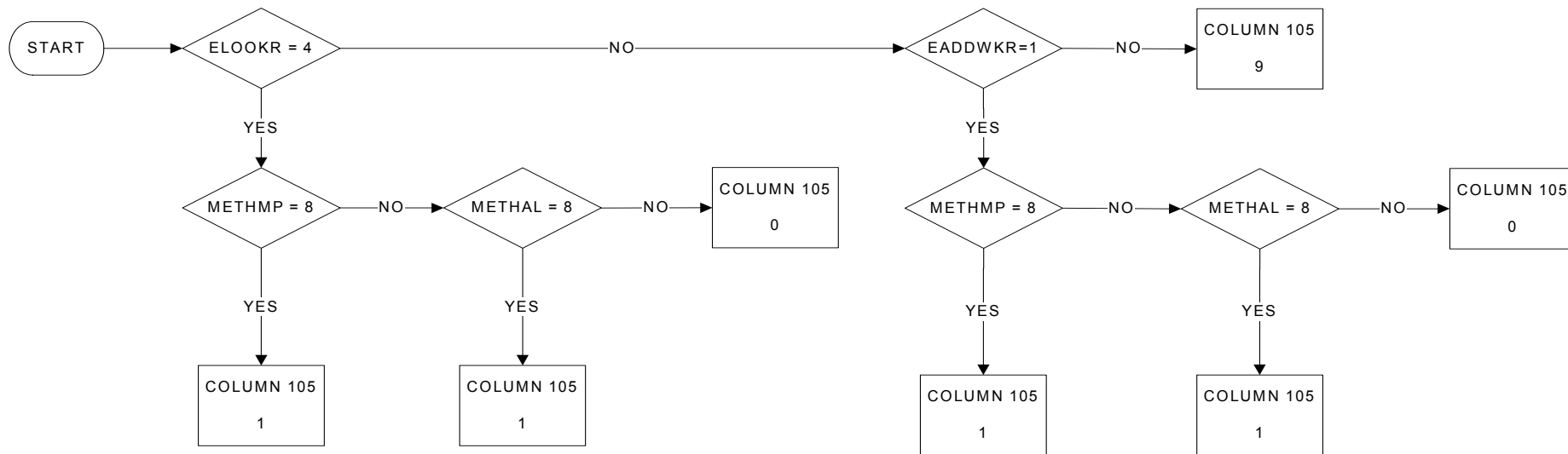

KEY	
0	No
1	Yes
9	Not applicable (SEEKWORK ? 4 and LOOKOJ ? 1)

METHODD (EMETH4R): Asked friends, relatives, trade unions etc

Column 106

PAGE 1 OF 1

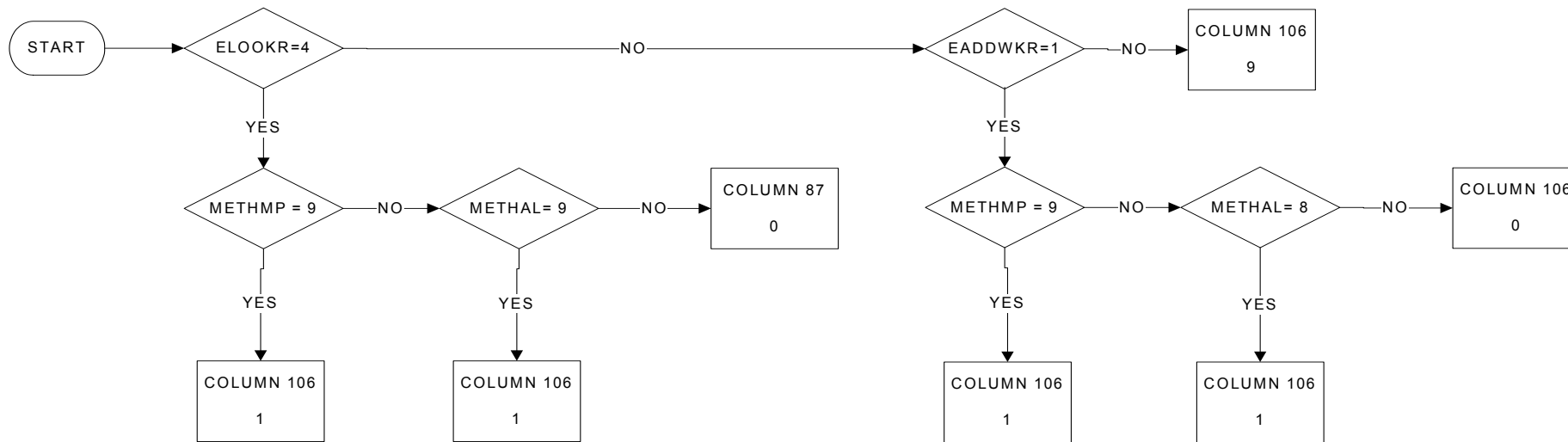

KEY	
0	No
1	Yes
9	Not applicable (SEEKWORK ? 4 and LOOKOJ ? 1)

METHODE (EMETH5R): Inserted or answered adverts in newspapers or journals

Column 107
PAGE 1 OF 1

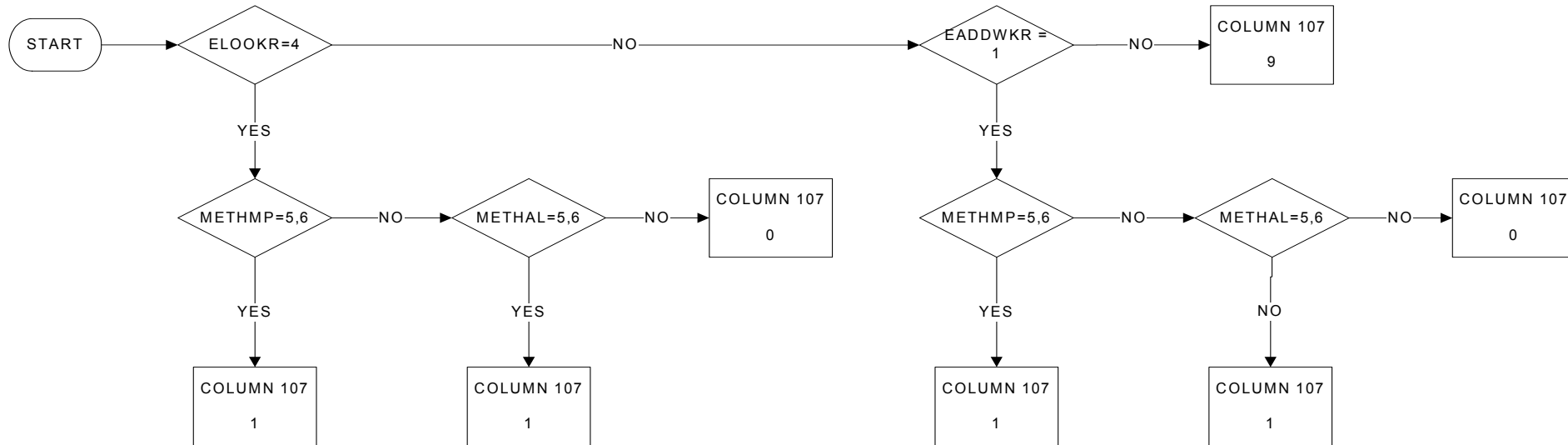

KEY	
0	No
1	Yes
9	Not applicable (SEEKWORK ? 4 and LOOKOJ ? 1)

METHOD (EMETH6R): Studied adverts in newspapers or journals

Column 108
PAGE 1 OF 1

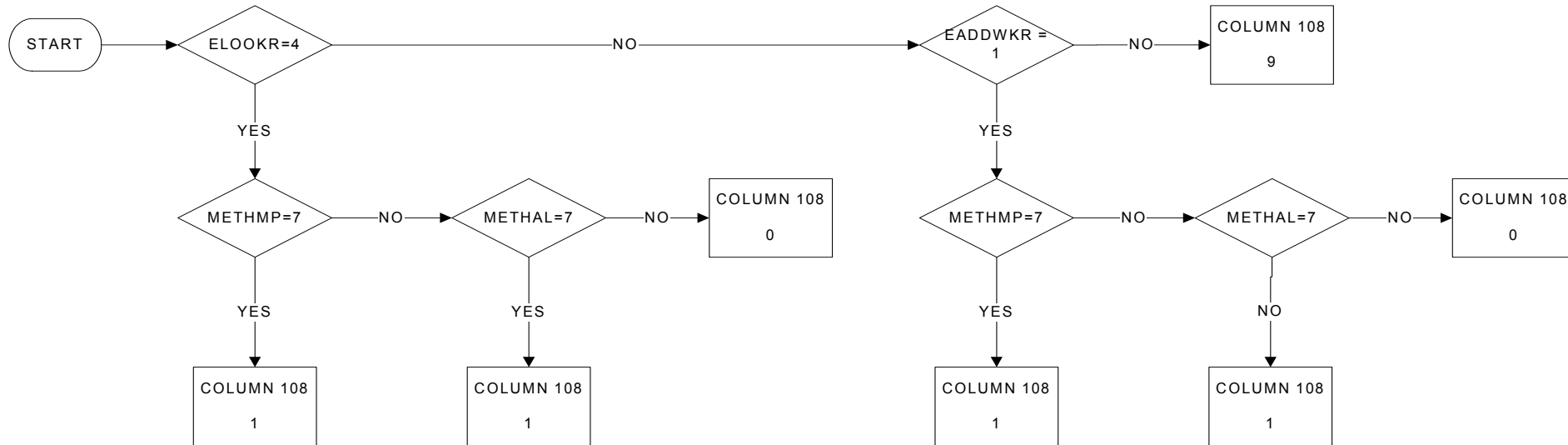

KEY	
0	No
1	Yes
9	Not applicable (SEEKWORK ? 4 and LOOKOJ ? 1)

METHODG (EMETH7R): Took a test, interview or examination

Column 109
PAGE 1 OF 1

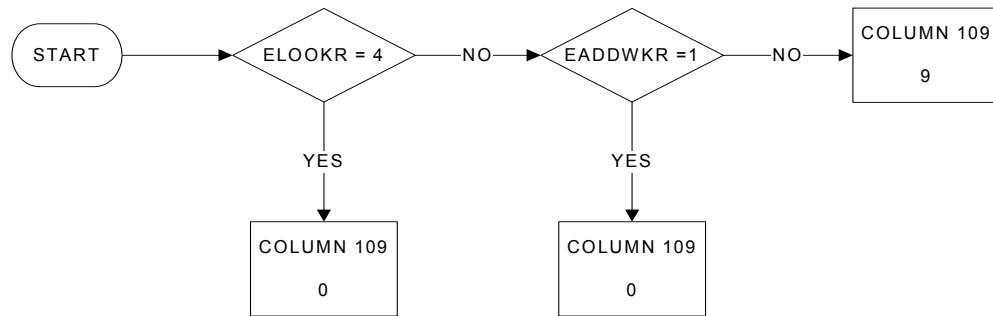

KEY

0 No
1 Yes
9 Not applicable (SEEKWORK ? 4 and LOOKOJ ? 1)

Notes

An answer of No (0) is given for all respondents as taking a test, interview or examination as a method of FINDING work is not used in the UK.

METHODH (EMETH8R): Looked for land, premises or equipment

Column 110
PAGE 1 OF 1

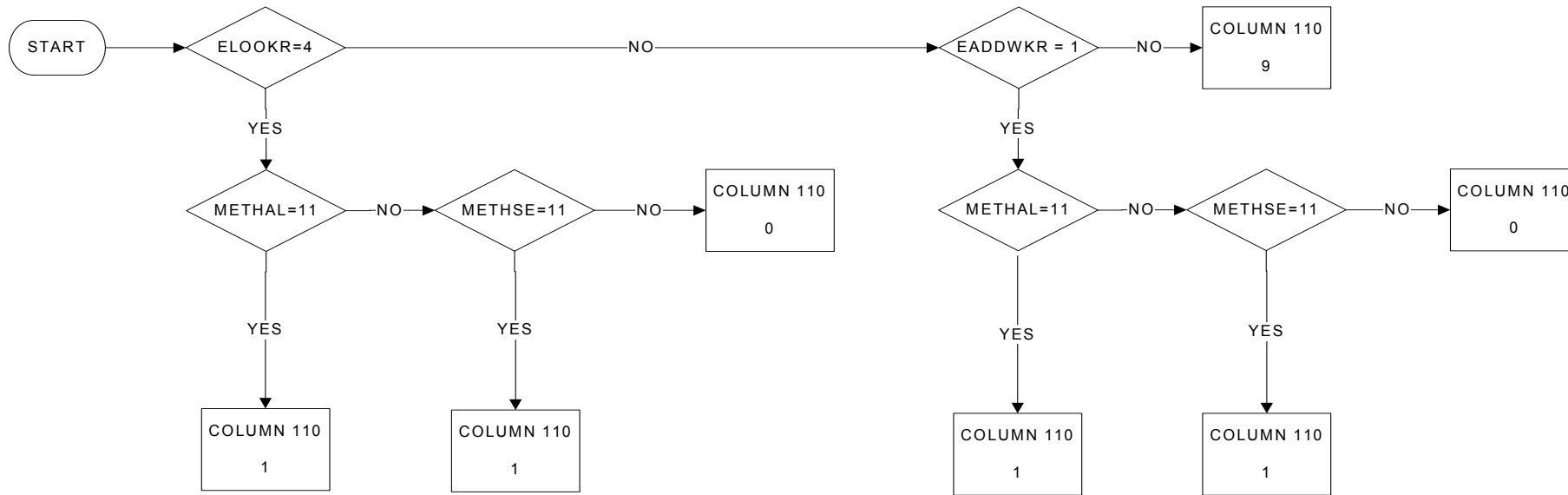

KEY	
0	No
1	Yes
9	Not applicable (SEEKWORK ? 4 and LOOKOJ ? 1)

METHOD1 (EMETH9R): Looked for permits, licenses or financial resources

Column 111

PAGE 1 OF 1

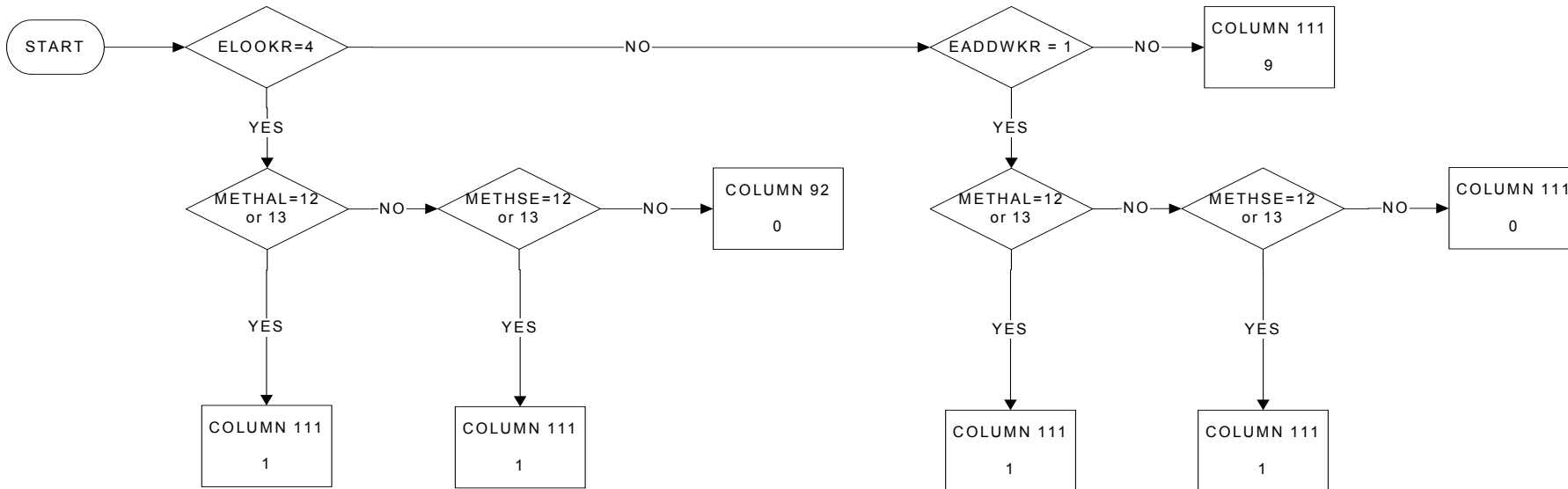

KEY	
0	No
1	Yes
9	Not applicable (SEEKWORK ? 4 and LOOKOJ ? 1)

METHODJ (EMETH10R): Awaiting results of job application

Column 112
PAGE 1 OF 1

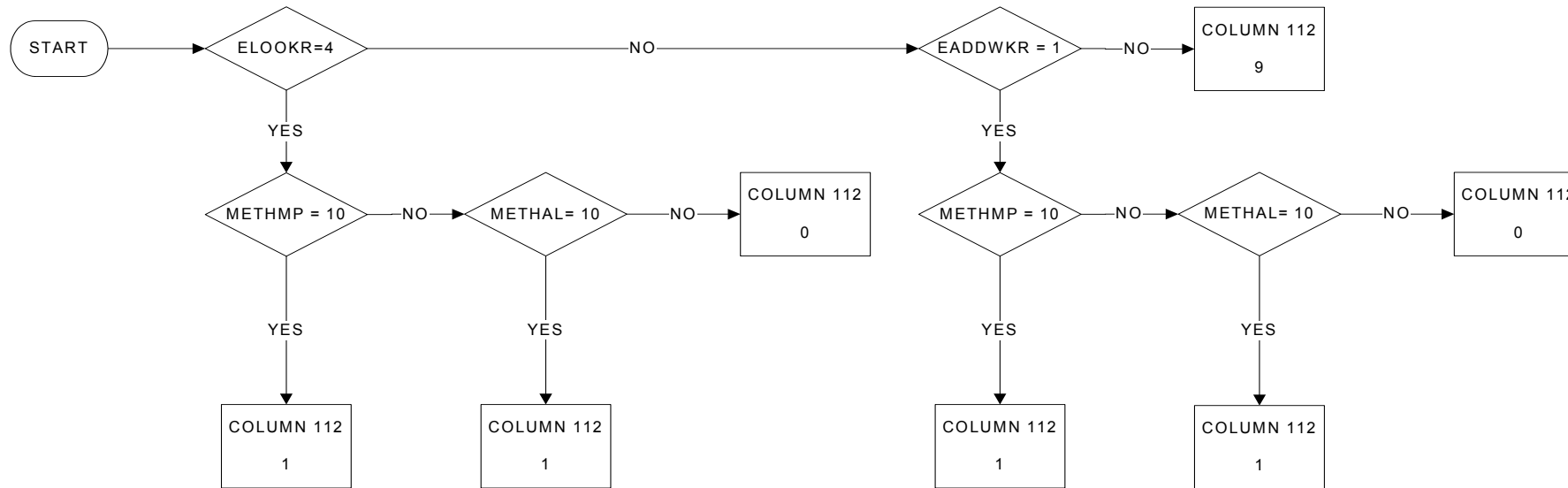

KEY	
0	No
1	Yes
9	Not applicable (SEEKWORK ? 4 and LOOKOJ ? 1)

METHODK (EMETH11R): Waiting for a call from a public employment office

Column 113
PAGE 1 OF 1

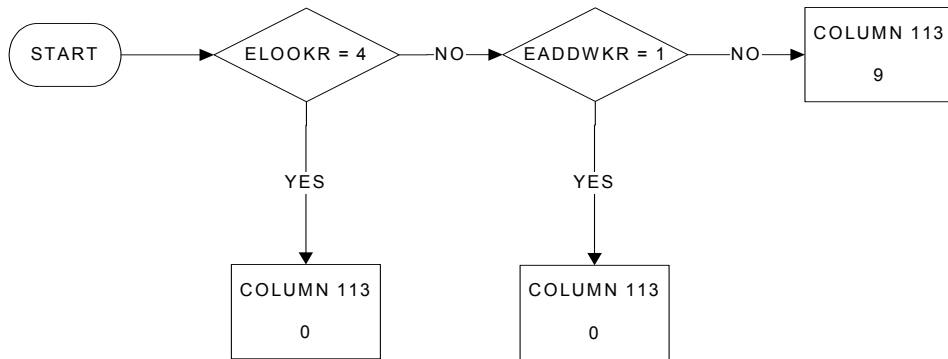

KEY

0	No
1	Yes
9	Not applicable (SEEKWORK ? 4 and LOOKOJ ? 1)

Notes

An answer of No (0) is given for all respondents as taking a test, interview or examination as a method of FINDING work is not used in the UK.

METHODL (EMETH12R): Awaiting results of a competition for recruitment to public sector

Column 114
PAGE 1 OF 1

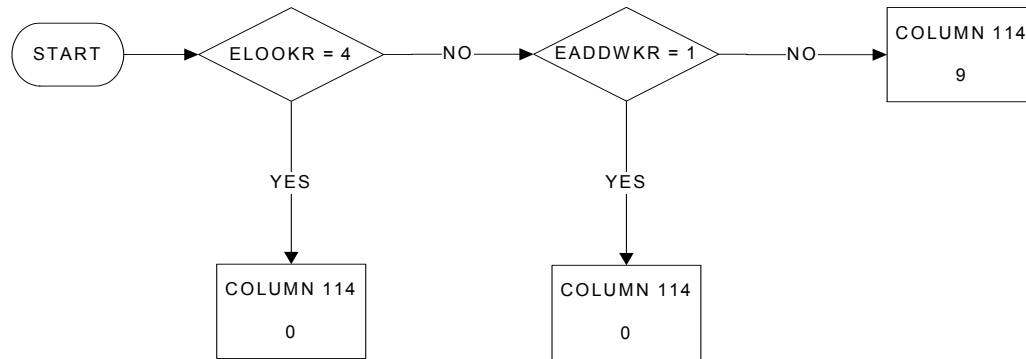

KEY

0	No
1	Yes
9	Not applicable (SEEKWORK ? 4 and LOOKOJ ? 1)

Notes

An answer of No (0) is given for all respondents as taking a test, interview or examination as a method of FINDING work is not used in the UK.

METHODM (EMETH13R): Other job search method used

Column 115
PAGE 1 OF 1

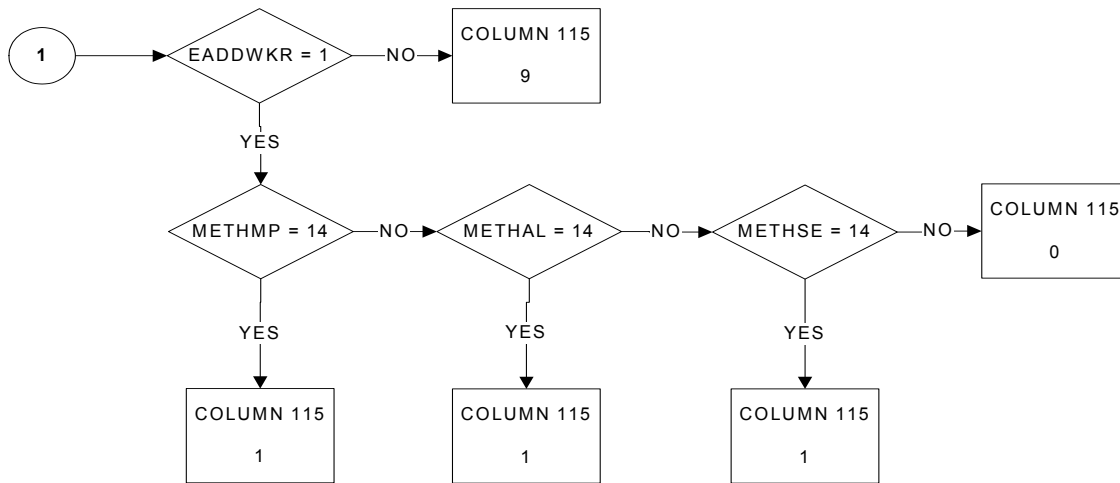
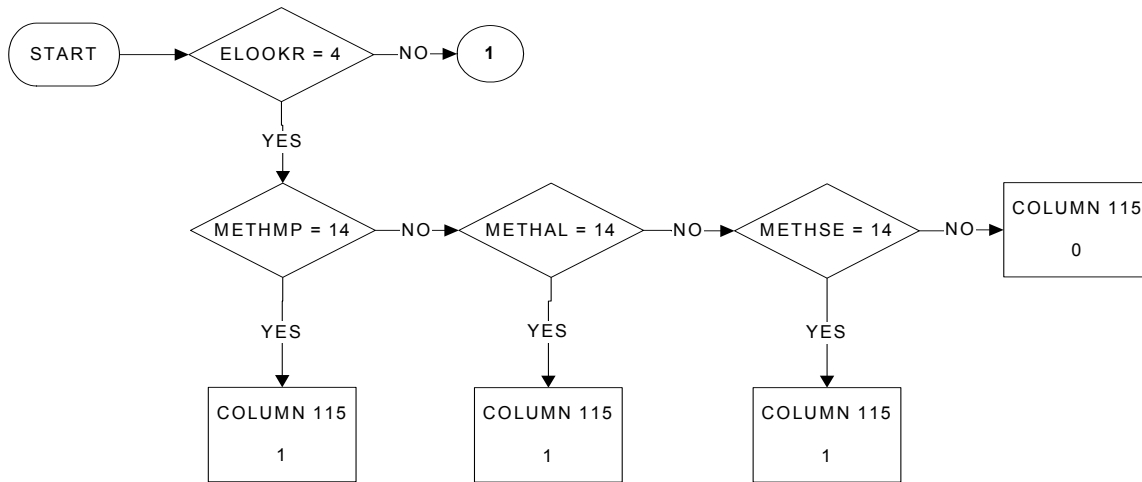

KEY	
0	No
1	Yes
9	Not applicable (SEEKWORK ? 4 and LOOKOJ ? 1)

WANTWORK (ELIKWKR): Willingness to work for person not seeking employment

Column 116
PAGE 1 OF 1

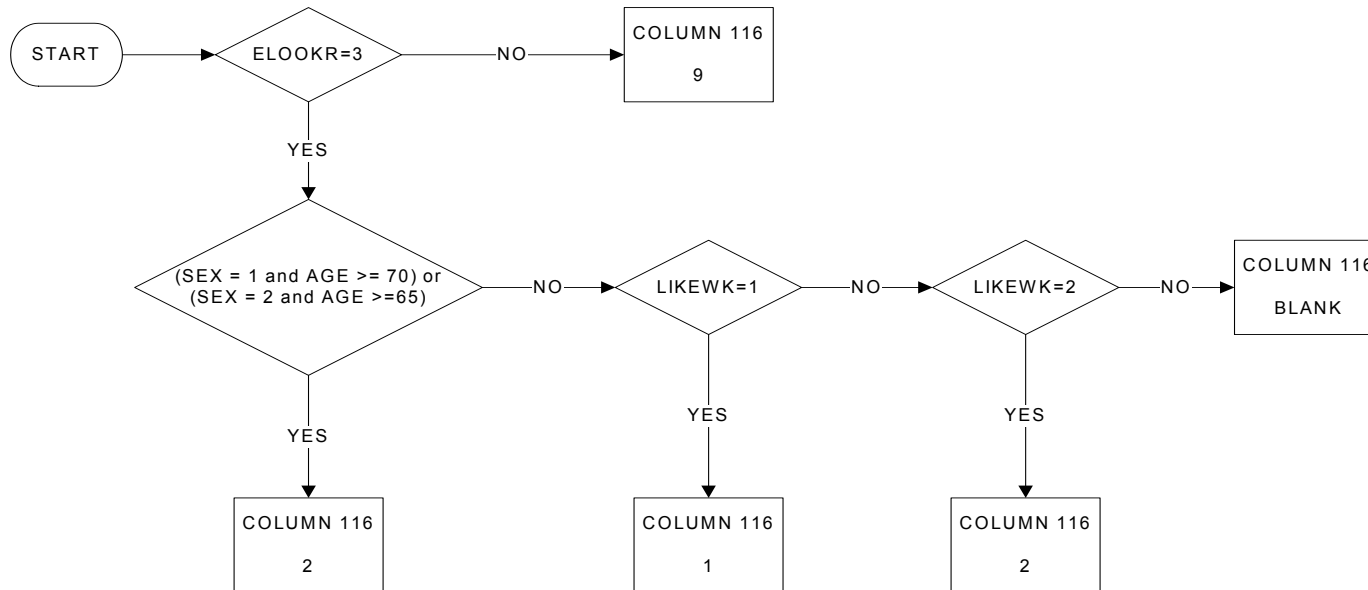

KEY	
1	But would nevertheless like to have work
2	And does not want to have work
9	Not applicable (SEEKWORK = 3)
BLANK	No answer

AVAILABLE (EAVALKWR): Availability to start work within two weeks

Column 117
PAGE 1 OF 1

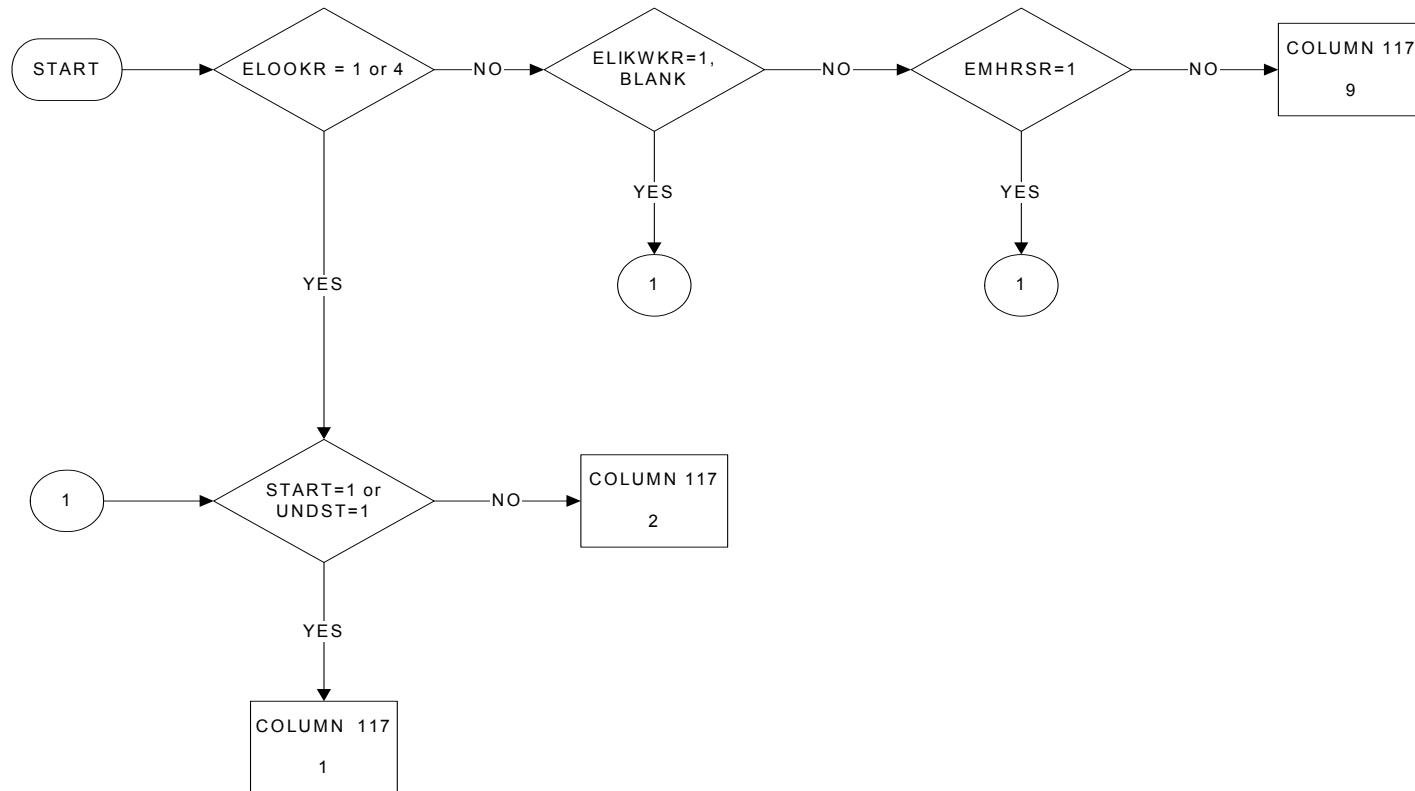

KEY

- 1 Person could start to work immediately (within 2 weeks)
- 2 Person could not start to work immediately (within 2 weeks)
- 9 Not applicable (SEEKWORK ? 1, 4 and WANTWORK ? 1, BLANK and WISHMORE ? 1)

AVAIRES (EVALREA): Reasons for not being available to start work within two weeks

Column 118
PAGE 1 OF 1

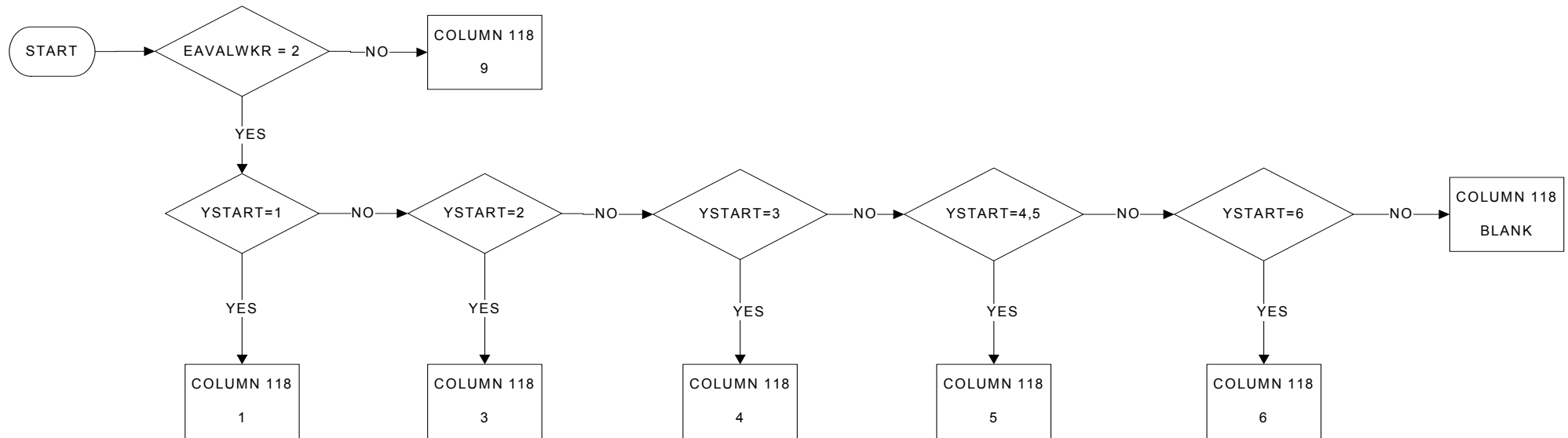

KEY

- 1 He/she must complete education or training
- 2 He/she must complete compulsory military or community service
- 3 He/she cannot leave present employment within two weeks due to period of notice
- 4 Of personal or family responsibilities (including maternity)
- 5 Of own illness or incapacity
- 6 Of other reasons
- 9 Not applicable (AVAILBLE ? 2)
- BLANK No answer

PRESEEK (EBEFORER): Situation immediately before seeking work

Column 119
PAGE 1 OF 1

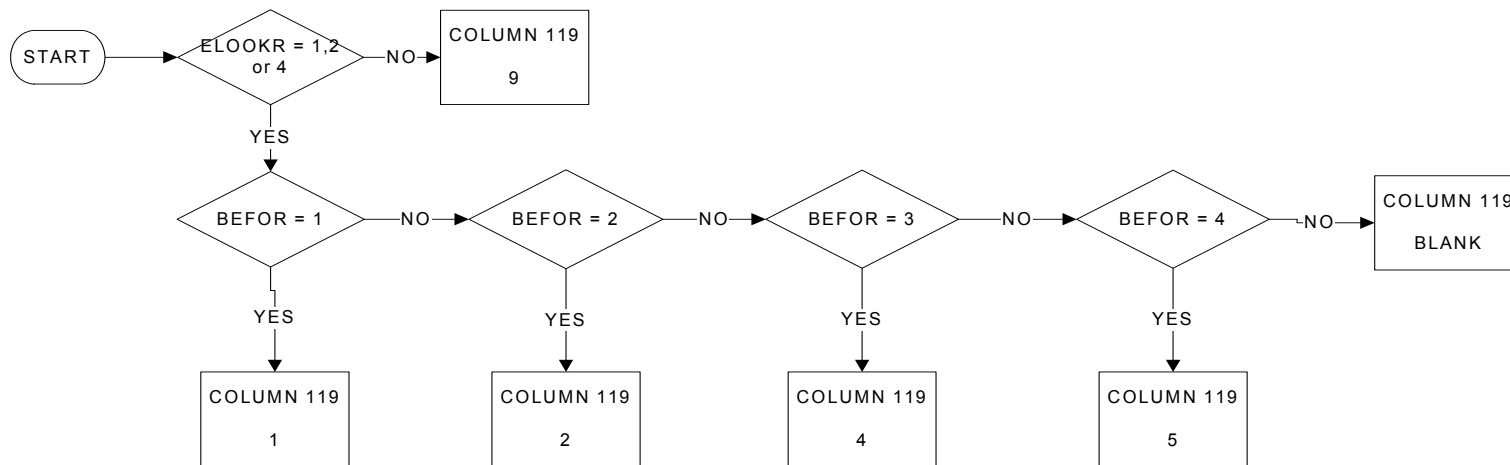

KEY

- 1 Person was working (including apprentices, trainees)
- 2 Person was in full-time education (excluding apprentices, trainees)
- 3 Person was conscript on compulsory military or community service
- 4 Person had domestic/family responsibilities
- 5 Other (e.g. retired)
- 9 Not applicable (SEEKWORK =3,9)
- BLANK No answer

ENECARE: Need for care facilities

Column 120
PAGE 1 OF 1

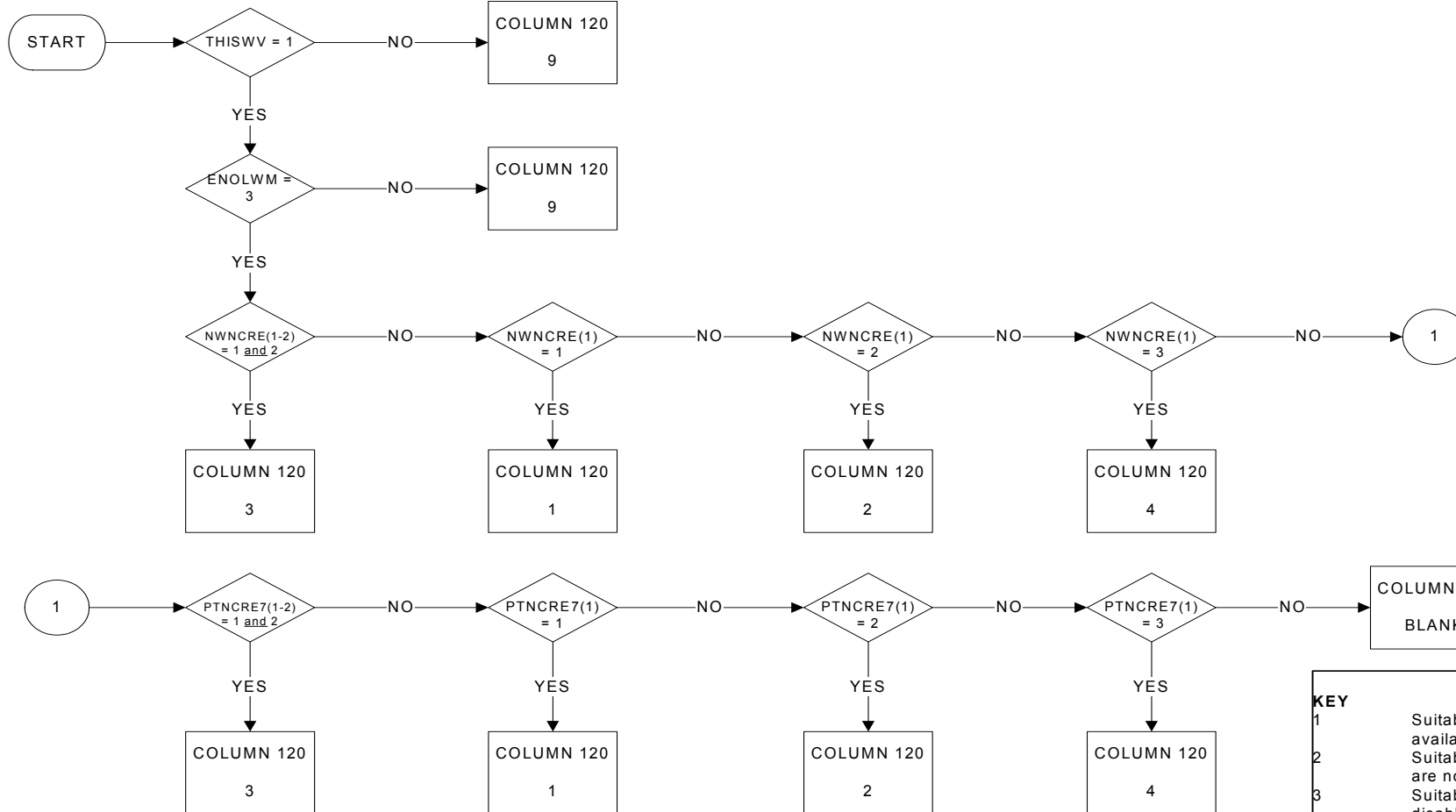

KEY	
1	Suitable care services for children are not available or affordable
2	Suitable care services for ill, disabled, elderly are not available or affordable
3	Suitable care services for both children and ill, disabled and elderly are not available or affordable
4	Care facilities do not influence decision for working part time or not searching for a job
9	Not applicable (ENOLWM NE 3 or THISWV NE 1)
Blank	No answer

REGISTER (EREGPUB): Registration at a Public Employment Office

Column 121
PAGE 1 OF 1

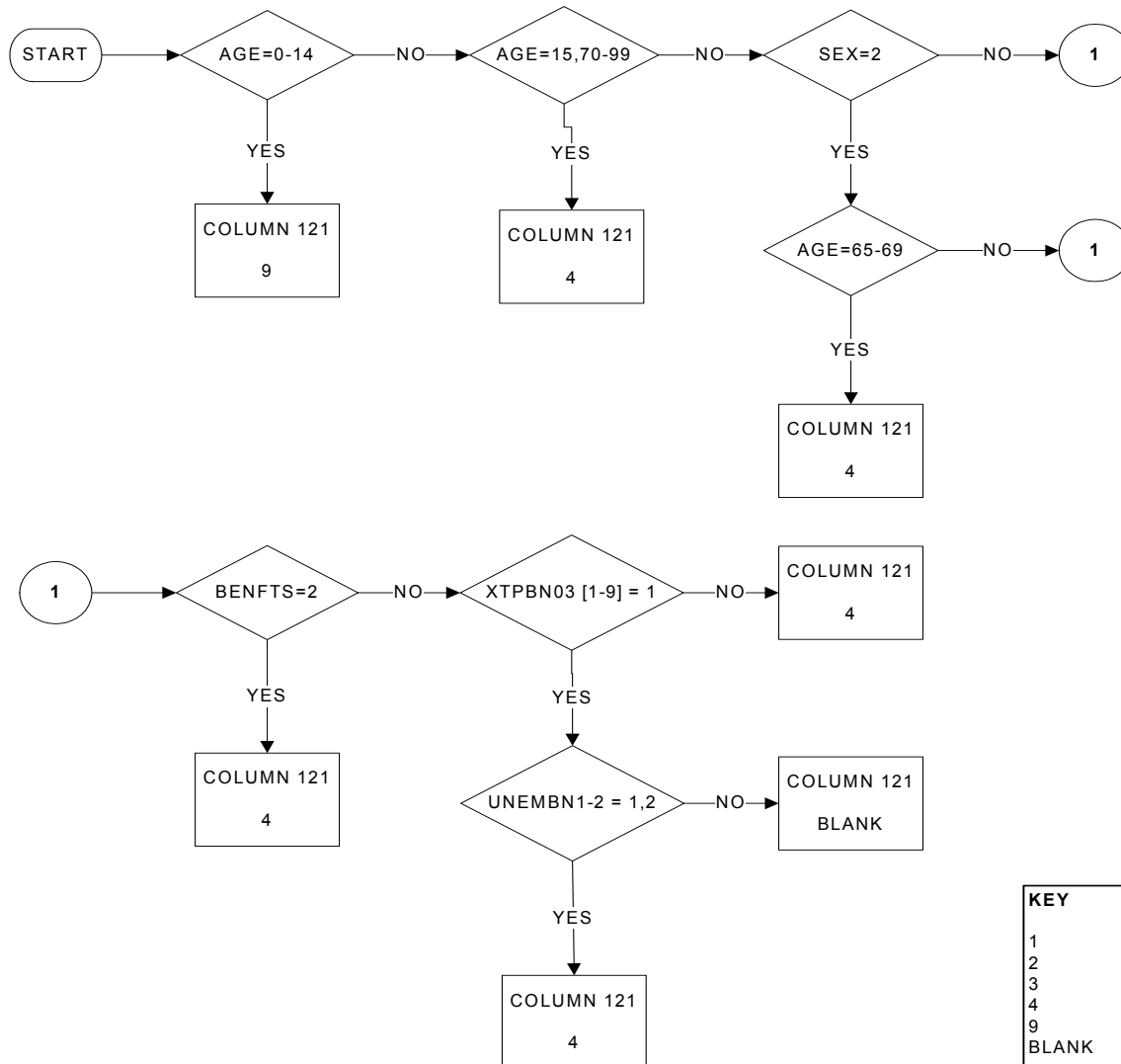

KEY

- 1 Person is registered at a public employment office and receives benefit or assistance
- 2 Person is registered at a public employment office but does not receive benefit or assistance
- 3 Person is not registered at a public employment office but receives benefit or assistance
- 4 Person is not registered at a public employment office and does not receive benefit or assistance
- 9 Not applicable (person aged less than 15 years or older than 75)
- BLANK No answer

EDUCSTAT (EDUCSTA): Student or apprentice in regular education during last four weeks

Column 123
PAGE 1 OF 1

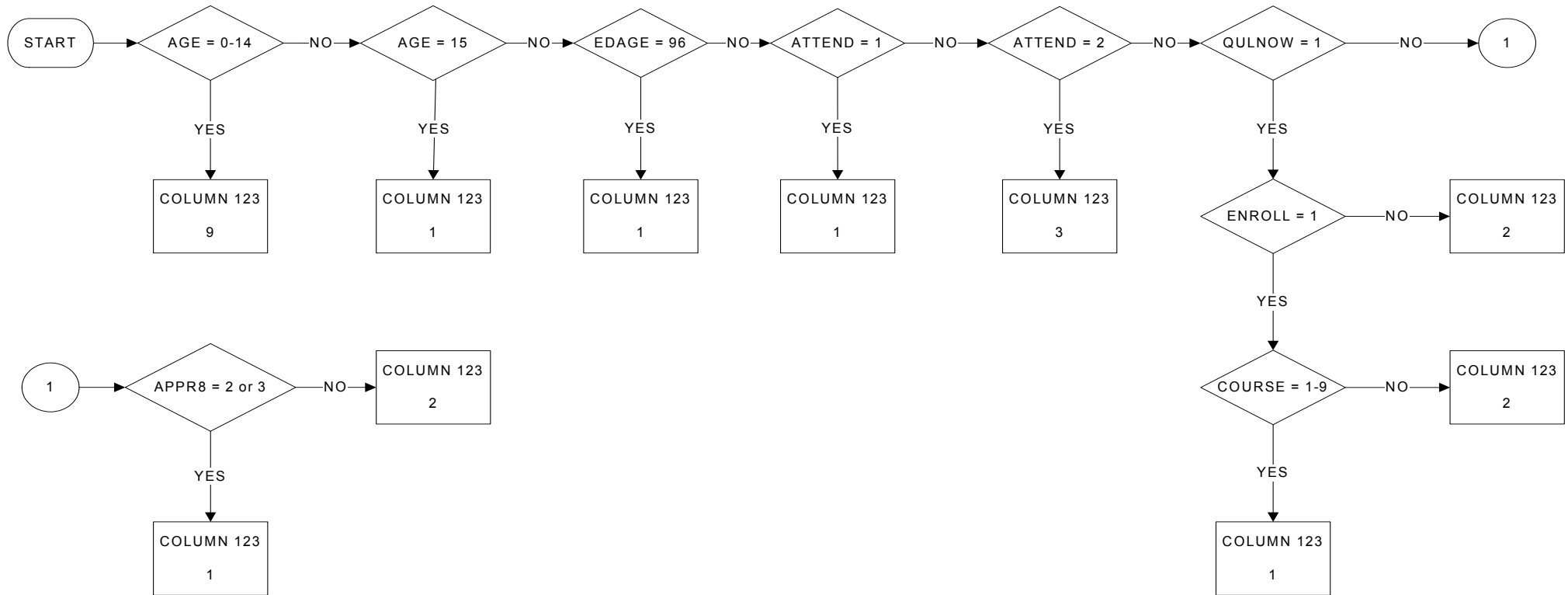

KEY	
1	Has been a student or an apprentice
2	Has not been a student or apprentice
3	Person in regular education but on holidays
9	Not applicable (child less than 15 years)
BLANK	No answer

EDUCLEVEL (EDUCLEV): Level of the current education or training

Column 124
PAGE 1 OF 2

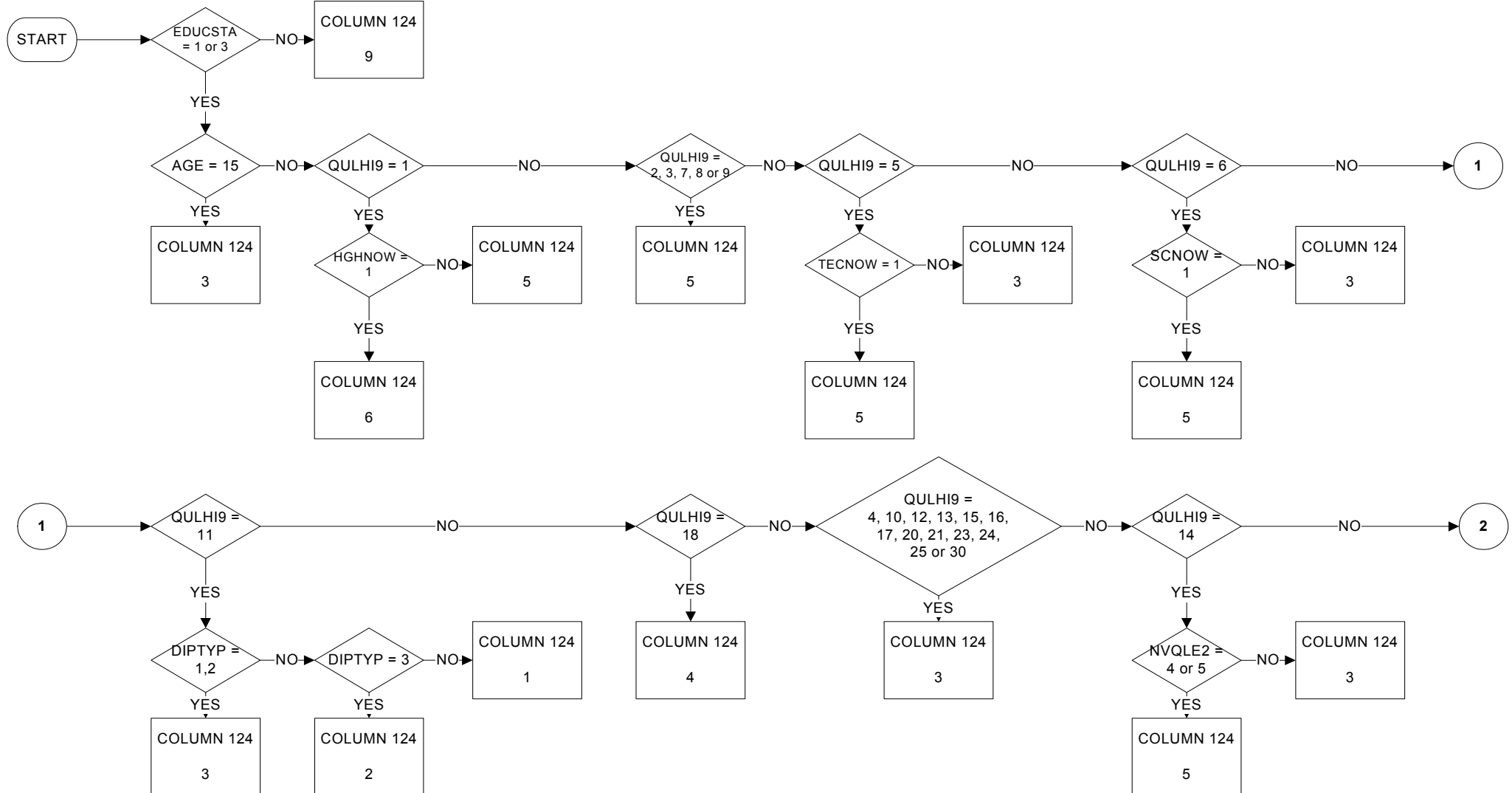

EDUCLEVEL (EDUCLEV): Level of the current education or training

Column 124

PAGE 2 OF 2

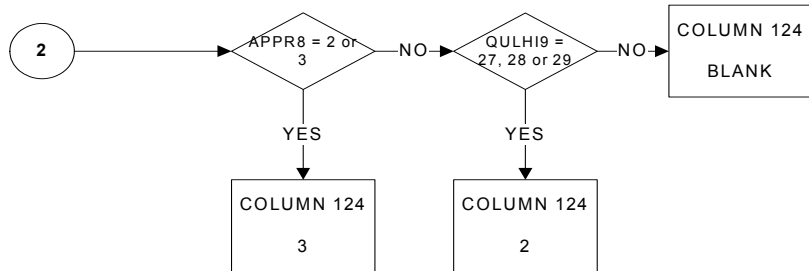

KEY	
1	ISCED 1
2	ISCED 2
3	ISCED 3
4	ISCED 4
5	ISCED 5
6	ISCED 6
9	Not applicable (EDUCSTAT = 2, 9 or BLANK)
BLANK	No answer
Notes	
HGHNOW was quarterly specific (spring and Autumn), but was changed to being all quarters from D03F.	

EDUCFILD (EDUCFLD): Field of this education or training

Columns 125/127

PAGE 1 OF 2

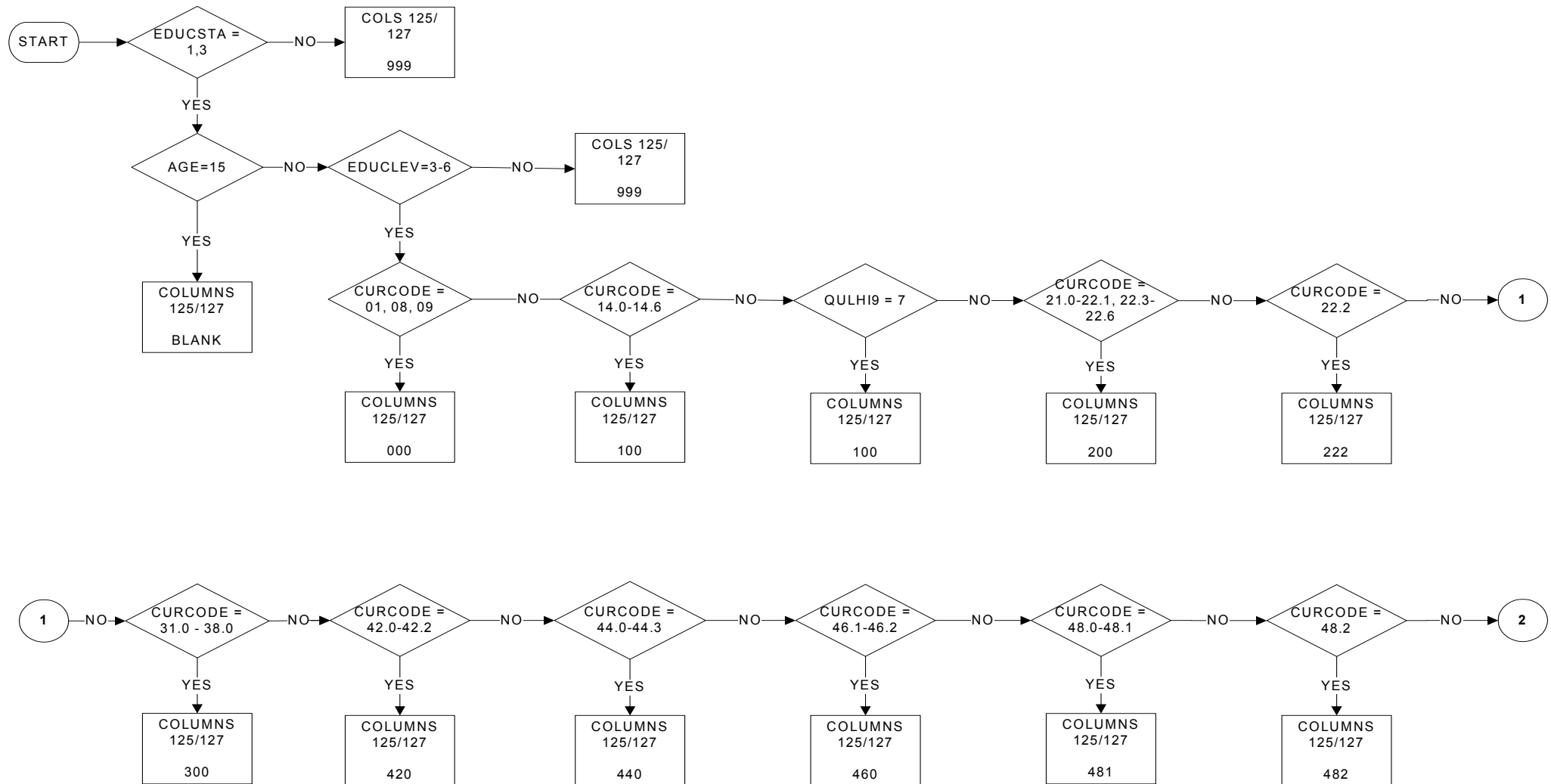

EDUCFILD (EDUCFLD): Field of this education or training

Columns 125/127

PAGE 2 OF 2

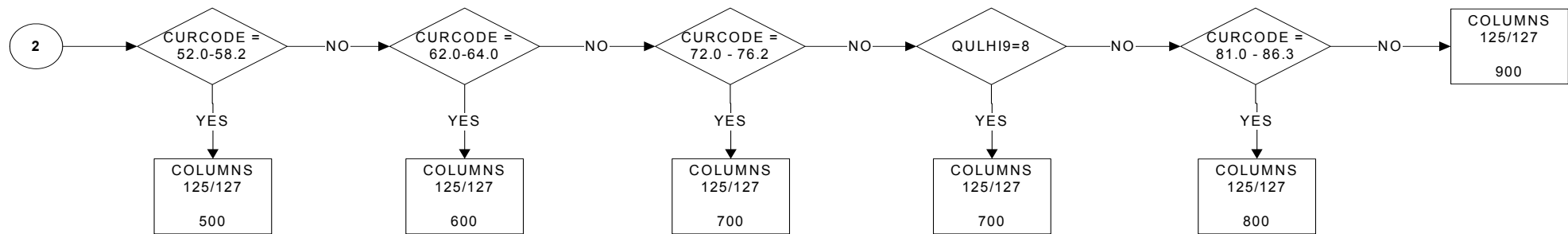

KEY

000	General programmes
100	Teacher training and education science
200	Humanities, language and arts
222	Foreign languages
300	Social science, business and law
400	Science, mathematics and computing
420	Life science (including biology and environmental science)
440	Physical science (including physics, chemistry and earth science)
460	Mathematics and statistics
481	Computer science
482	Computer use
500	Engineering, manufacturing and construction
600	Agriculture and veterinary
700	Health and welfare
800	Services
900	unknown
999	Not applicable (EDUCSTAT =2,9 BLANK or EDUCLEVL = 3-6)
BLANK	No answer

Notes

CURCODE values output as string not numeric, see attached coding frame

COURATT (ECOURA): Attendance at courses, seminars, private lessons etc outside regular education within last four weeks

Column 128
PAGE 1 OF 1

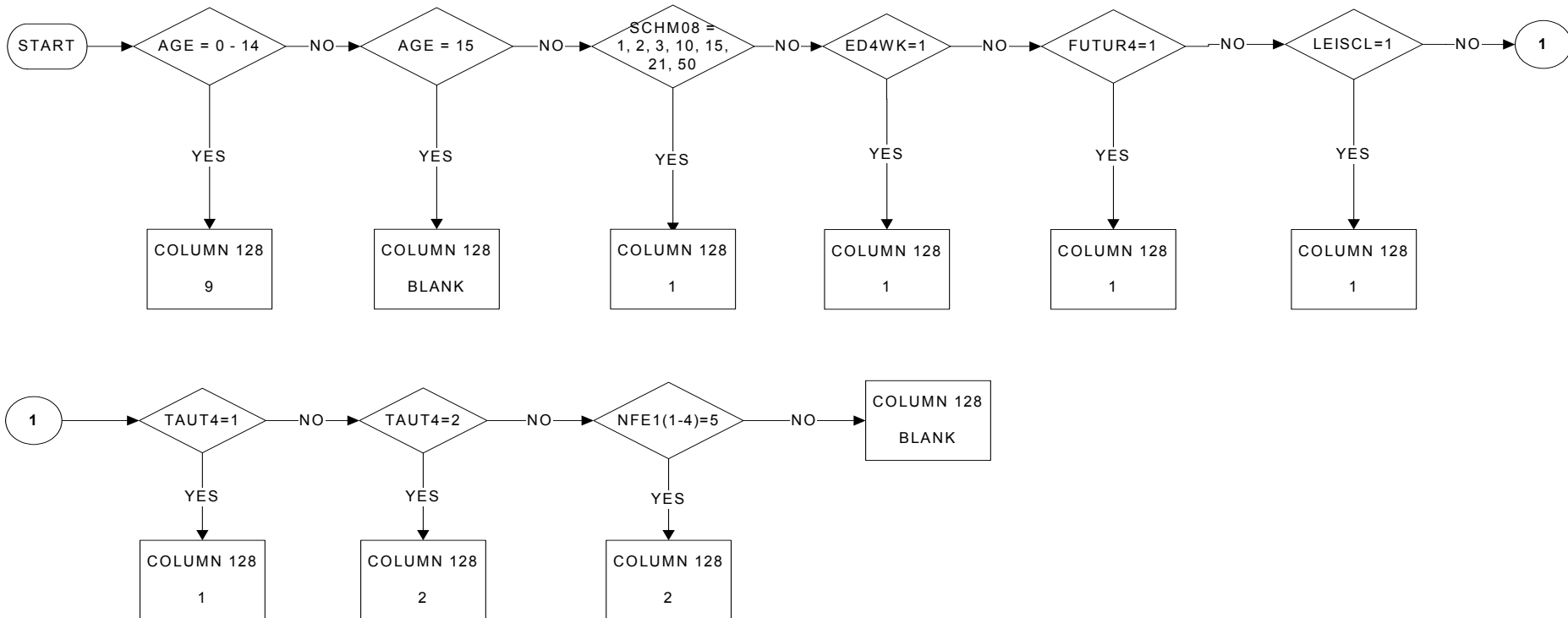

KEY	
1	Yes
2	No
9	Not applicable (child less than 15 years)
blank	No answer

COURLEN (ECOURL): Number of hours spent on all taught learning activities within the last four weeks

Columns 129/131

PAGE 1 OF 1

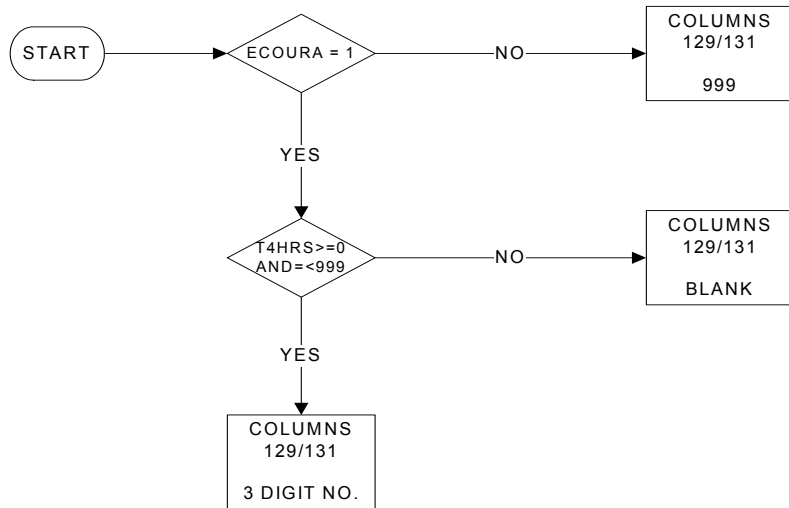

KEY	
3 digits	Number of hours
999	Not applicable (COURATT = 2, 9, blank)
blank	No answer

COURPURP (ECOURP): Purpose of the most recent taught learning activity

Column 132
PAGE 1 OF 1

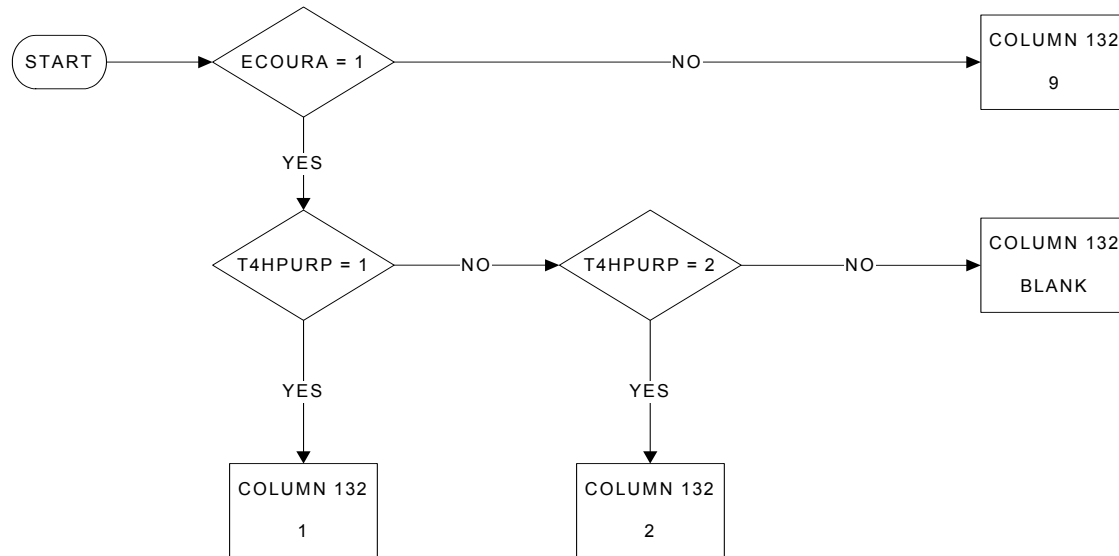

KEY	
1	Mostly job related (professional)
2	Mostly personal/social
9	Not applicable (COURATT = 2,9,blank)
blank	No answer

COURFILD (ECOURF): Field of the most recent taught learning activity

Column 133/135

PAGE 1 OF 2

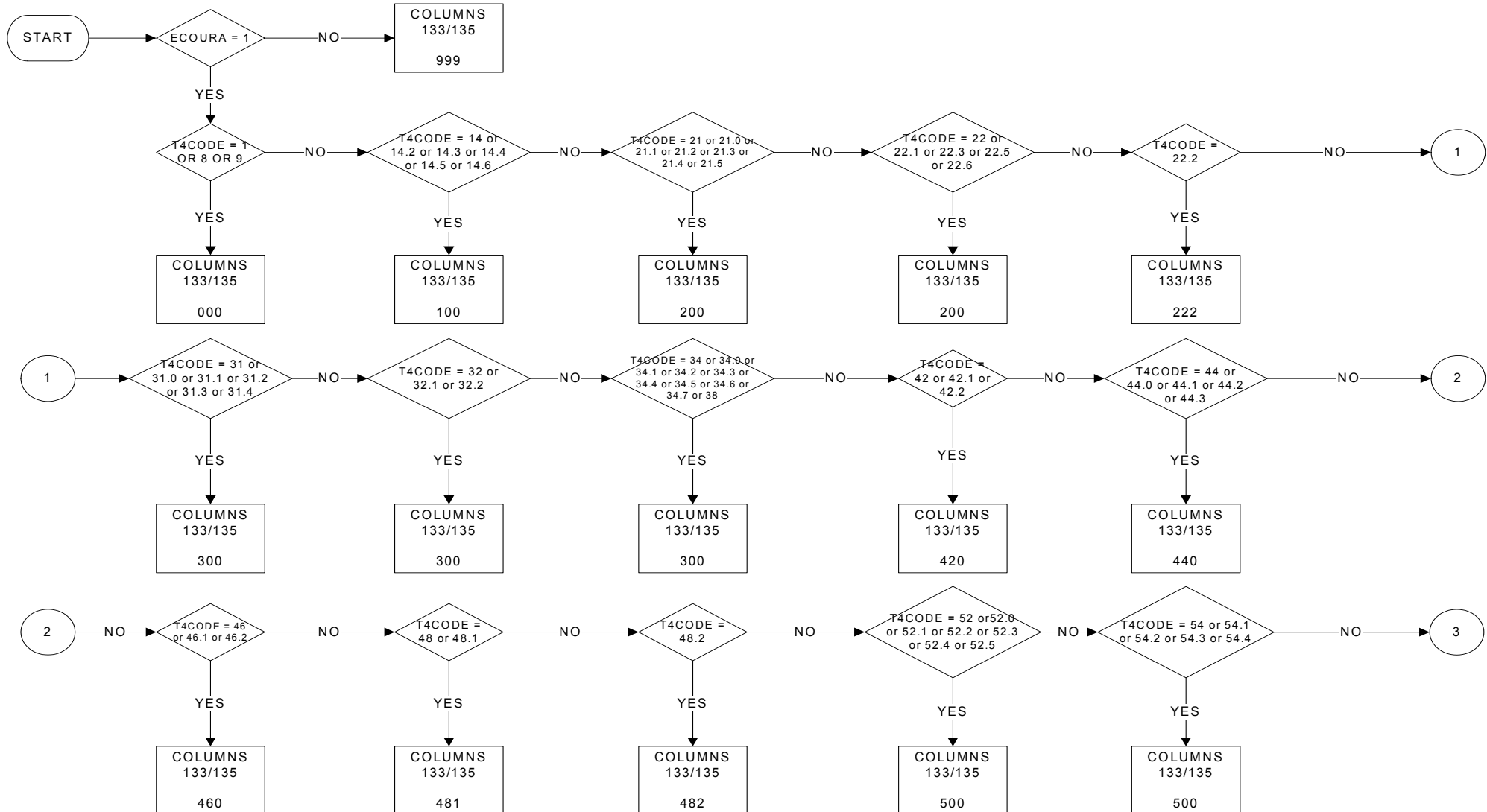

COURFILD (ECOURF): Field of the most recent taught learning activity

Column 133/135

PAGE 2 OF 2

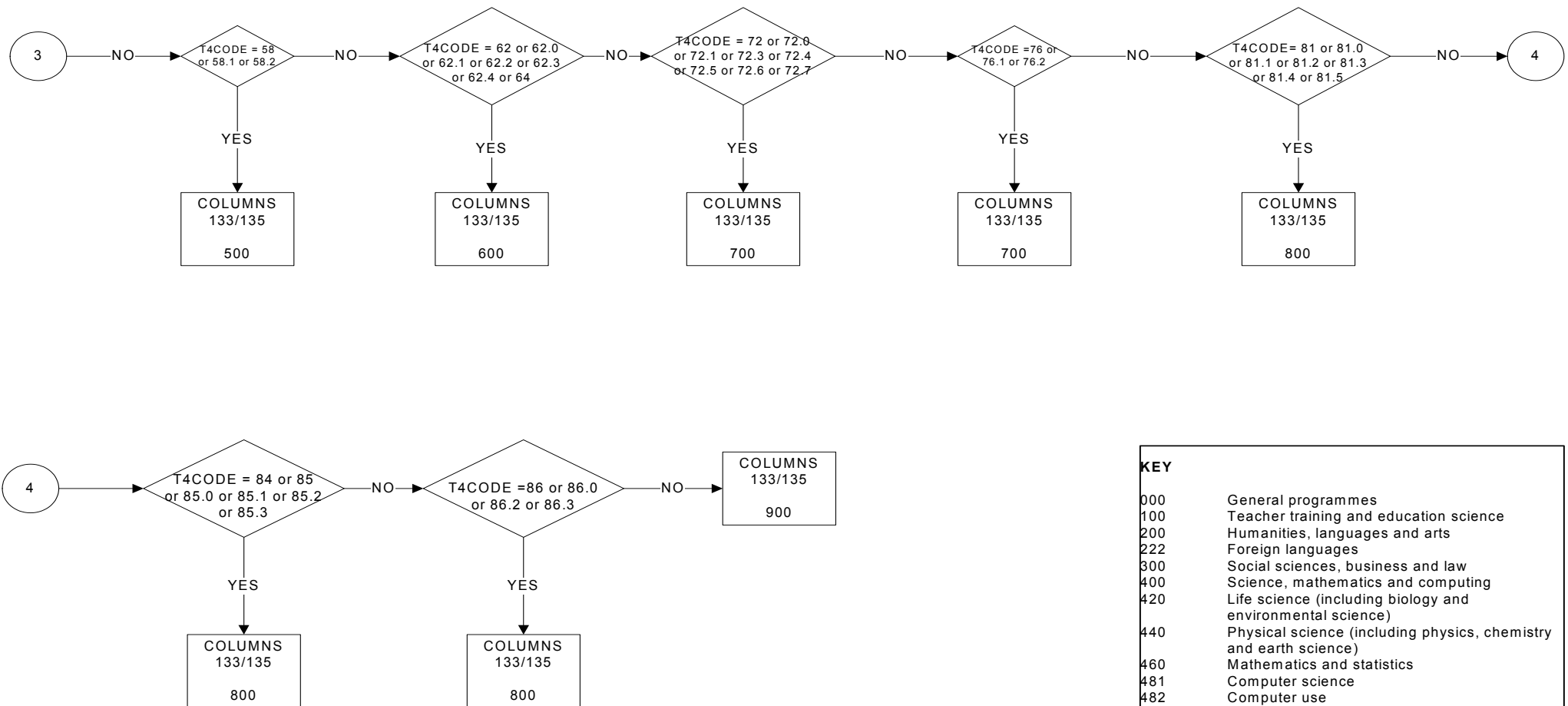

KEY	
000	General programmes
100	Teacher training and education science
200	Humanities, languages and arts
222	Foreign languages
300	Social sciences, business and law
400	Science, mathematics and computing
420	Life science (including biology and environmental science)
440	Physical science (including physics, chemistry and earth science)
460	Mathematics and statistics
481	Computer science
482	Computer use
500	Engineering, manufacturing and construction
600	Agriculture and veterinary
700	Health and welfare
800	Services
900	Unknown
999	Not applicable (COURATT = 2, 9, blank)
blank	No answer

COURWORK (ECOURW): Whether recent taught learning activity took place during paid working hours

Column 136
PAGE 1 OF 1

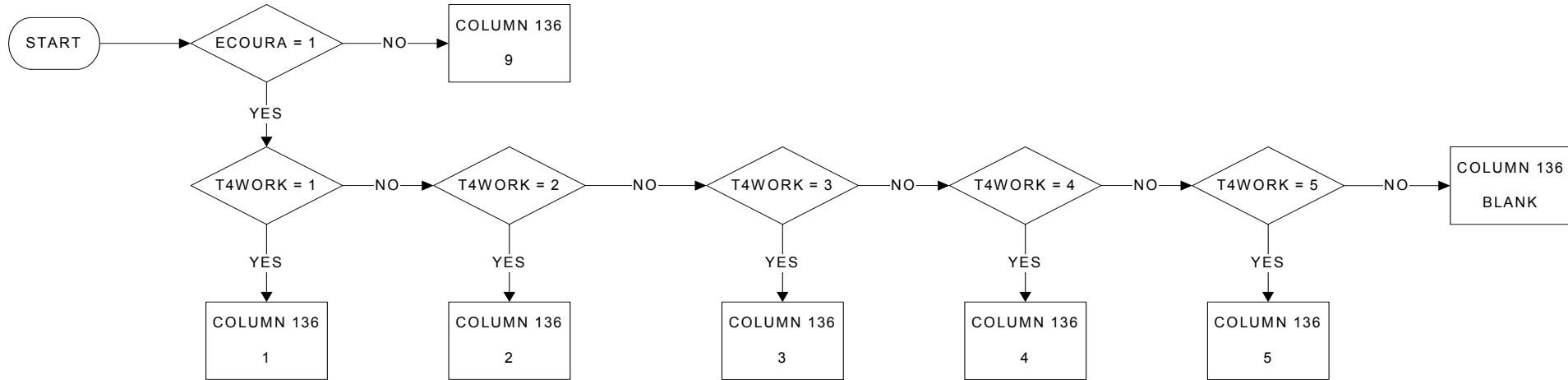

KEY	
1	Only during paid working hours
2	Mostly during paid working hours
3	Mostly outside paid working hours
4	Only outside paid working hours
5	No job at that time
9	Not applicable (COURATT = 2,9,blank)
blank	No answer

HATLEVEL (EHATLEV): Highest level of education or training successfully completed

Columns 137/138

PAGE 1 OF 1

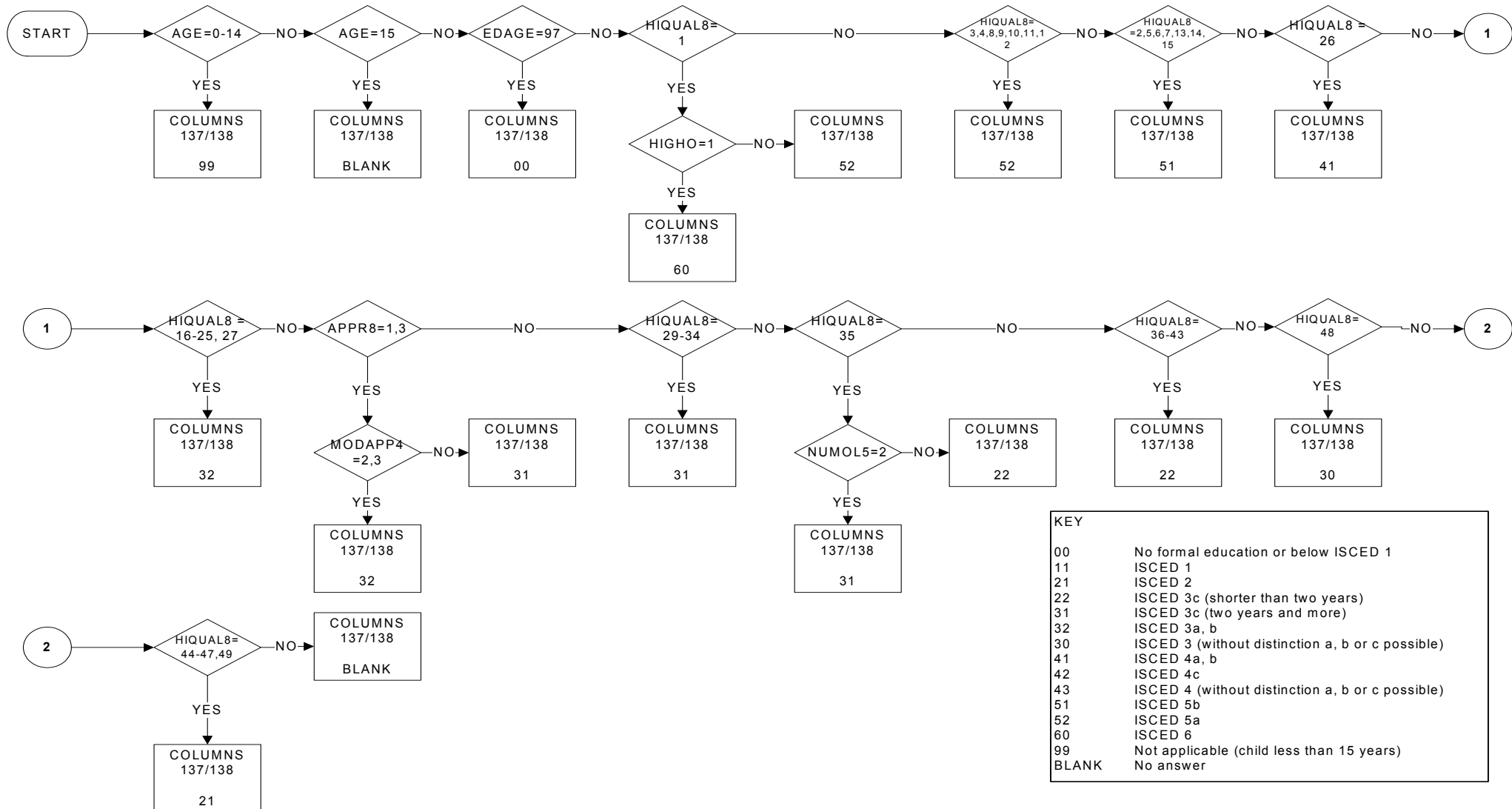

KEY	
00	No formal education or below ISCED 1
11	ISCED 1
21	ISCED 2
22	ISCED 3c (shorter than two years)
31	ISCED 3c (two years and more)
32	ISCED 3a, b
30	ISCED 3 (without distinction a, b or c possible)
41	ISCED 4a, b
42	ISCED 4c
43	ISCED 4 (without distinction a, b or c possible)
51	ISCED 5b
52	ISCED 5a
60	ISCED 6
99	Not applicable (child less than 15 years)
BLANK	No answer

HATFIELD (EHATFLD): Field of highest level of education or training successfully completed

Columns 139/141

PAGE 1 OF 2

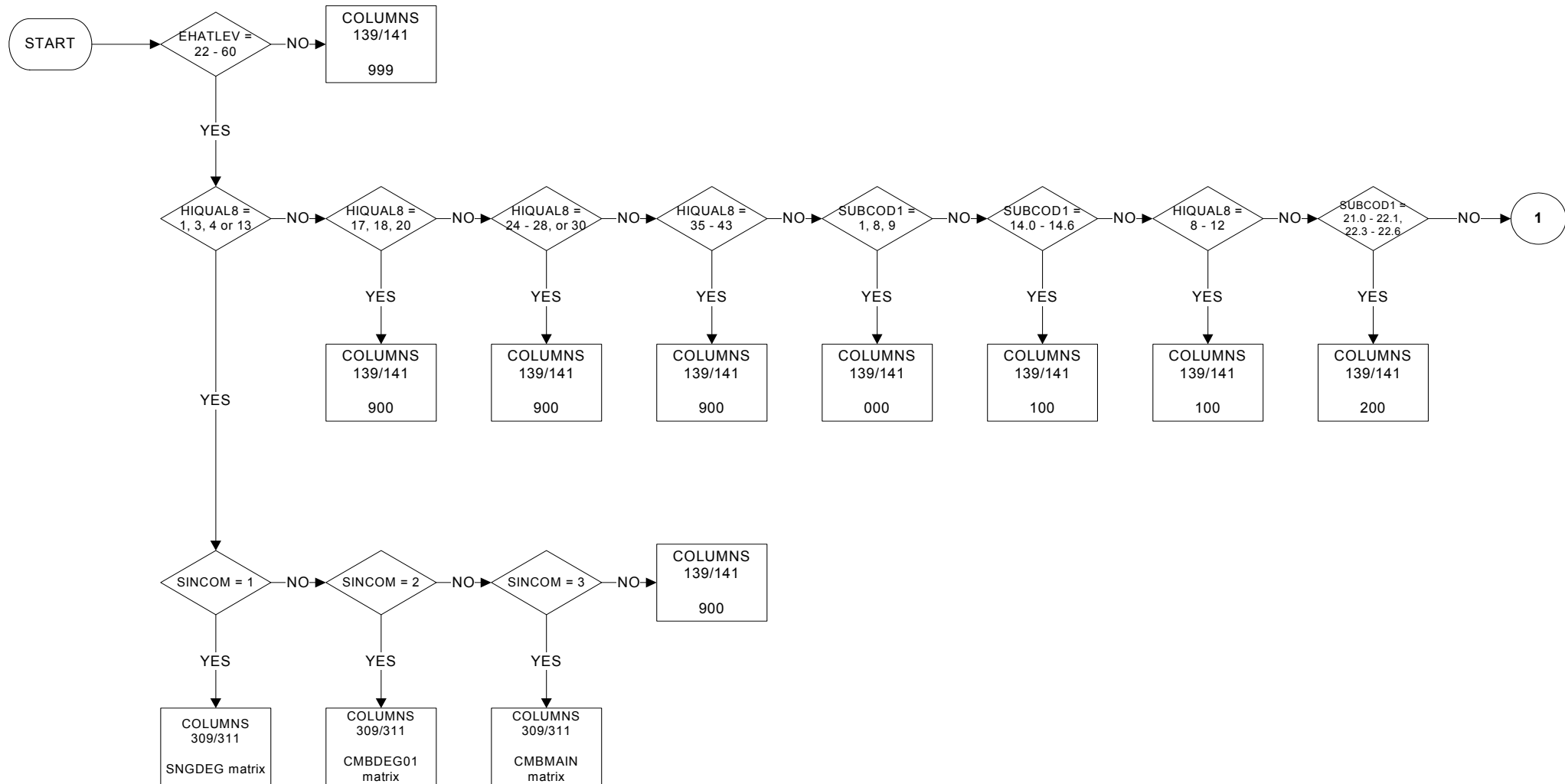

HATFIELD (EHATFLD): Field of highest level of education or training successfully completed

Columns 139/141

PAGE 2 OF 2

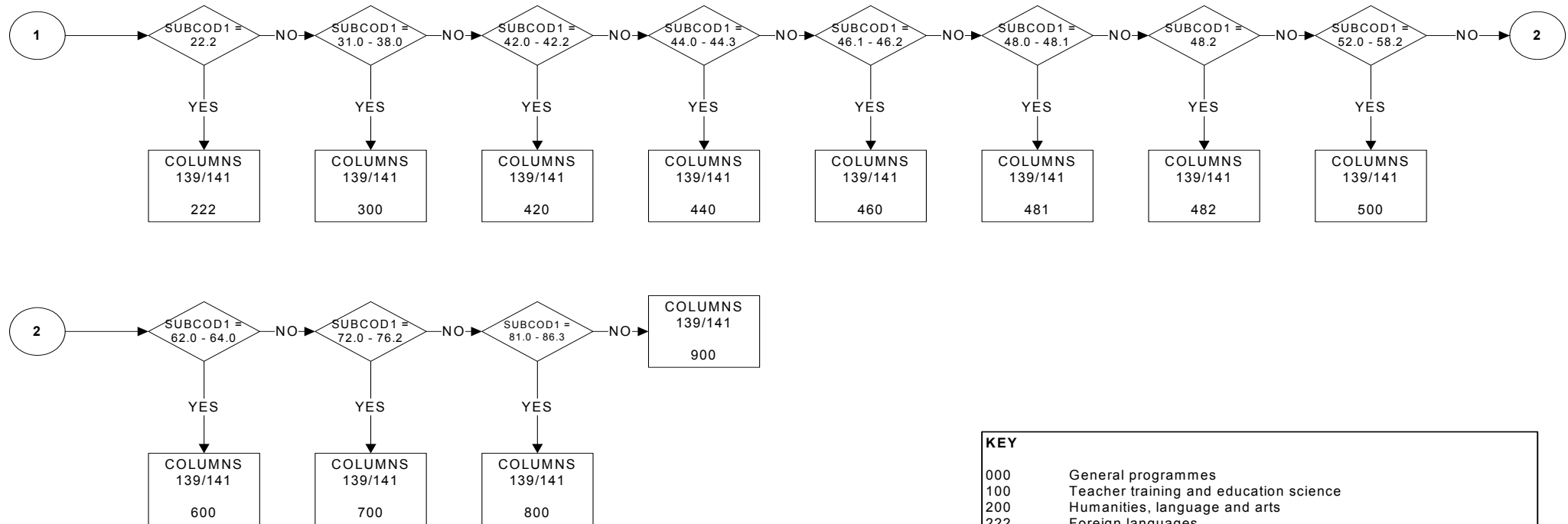

KEY

- 000 General programmes
- 100 Teacher training and education science
- 200 Humanities, language and arts
- 222 Foreign languages
- 300 Social science, business and law
- 400 Science, mathematics and computing
- 420 Life science (including biology and environmental science)
- 440 Physical science (including physics, chemistry and earth science)
- 460 Mathematics and statistics
- 481 Computer science
- 482 Computer use
- 500 Engineering, manufacturing and construction
- 600 Agriculture and veterinary
- 700 Health and welfare
- 800 Services
- 900 unknown
- 999 Not applicable (HATLEVEL = 00, 11, 21, 99, BLANK)
- BLANK No answer

Notes

SUBCOD1 values output as string not numeric, see attached coding frame.

HATYEAR (EHATYR): Year when highest level of education or training successfully completed

Columns 142/145

PAGE 1 OF 1

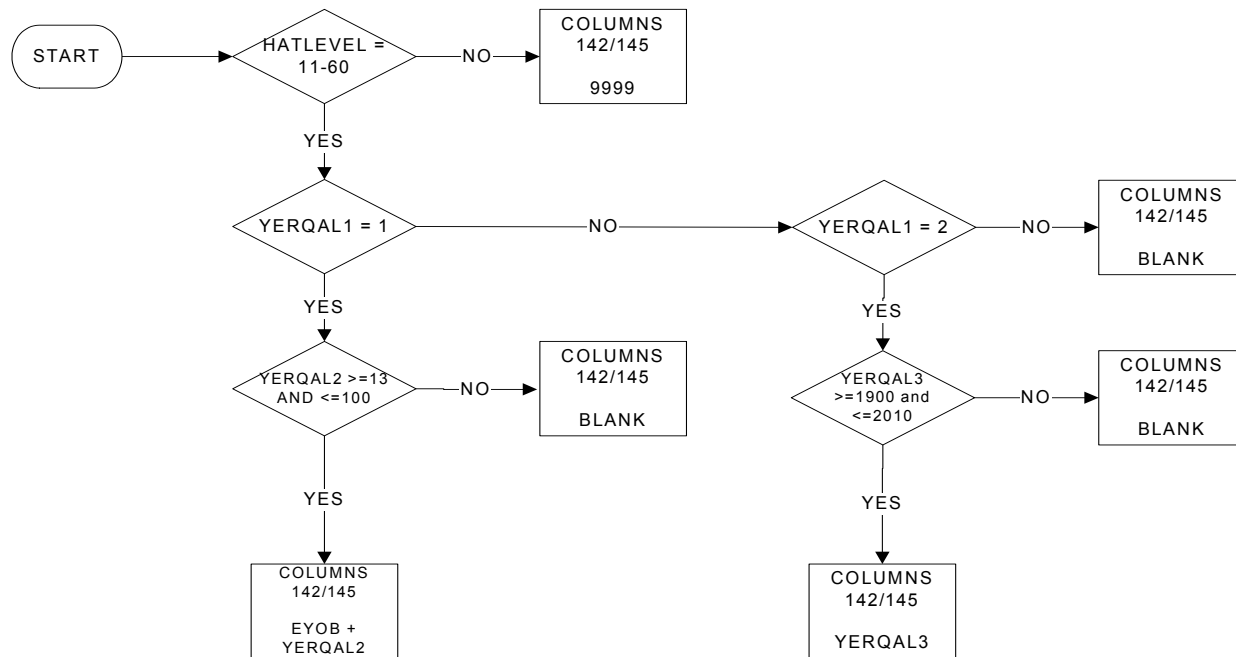

KEY

The 4 digits of year when highest level of education or training was successfully completed are entered

9999 Not applicable (HATLEVEL = 11-60)

BLANK No answer

WSTAT1Y (ESITONE): Situation with regard to activity one year ago

Column 146
PAGE 1 OF 1

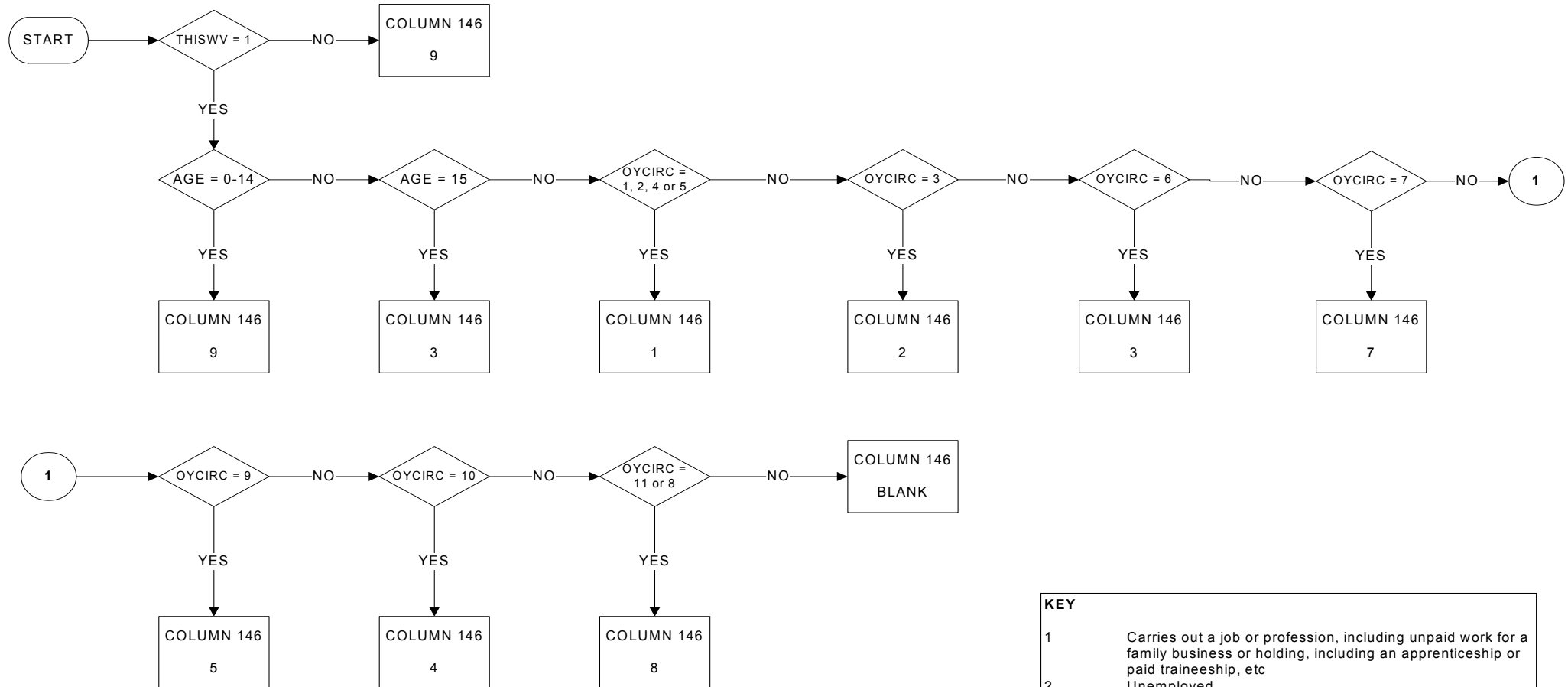

KEY	
1	Carries out a job or profession, including unpaid work for a family business or holding, including an apprenticeship or paid traineeship, etc
2	Unemployed
3	Pupil, student, further training, unpaid work experience
4	In retirement or early retirement or has given up business
5	Permanently disabled
6	In compulsory military service
7	Fulfilling domestic tasks
8	Other inactive person
9	Not applicable (child less than 15 years)
BLANK	No answer

STAPRO1Y (ESTATOR): Professional status one year before survey

Column 147

PAGE 1 OF 1

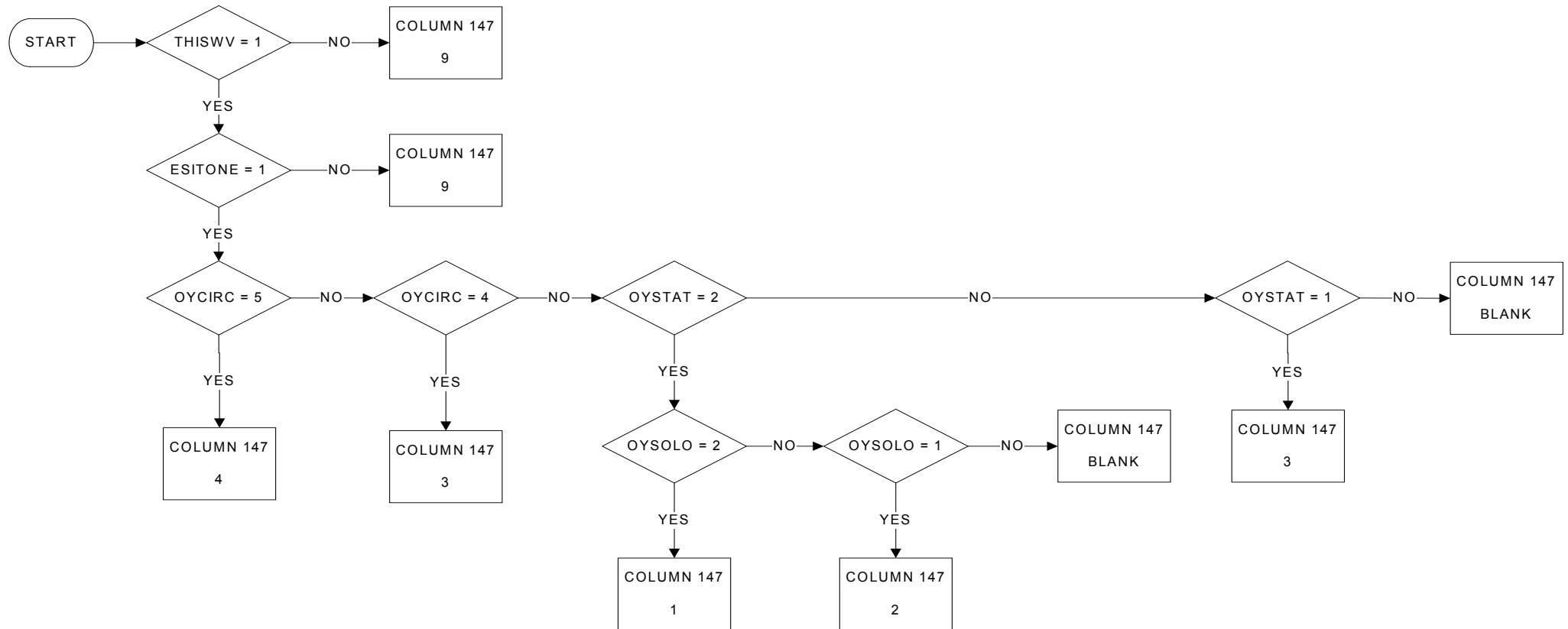

KEY	
1	Self-employed with employees
2	Self-employed without employees
3	Employee
4	Family-worker
9	Not applicable (WSTAT1Y ? 1)
BLANK	No answer

NACE1Y2D (ENACEO8): Economics activity of local unit in which person was working one year before survey

Column 148/149

PAGE 1 OF 1

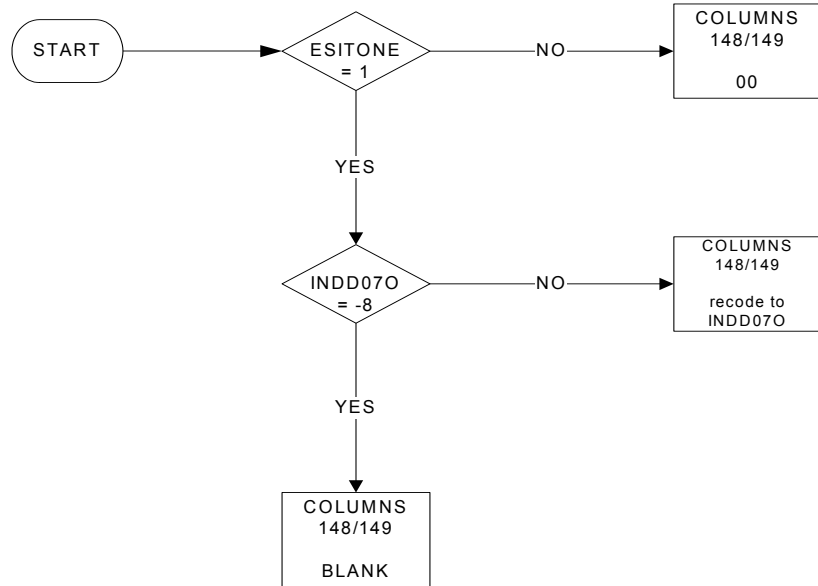

KEY	
	Nace Rev. 2
00	Not applicable (WSTAT1Y ? 1)
Blank	No answer

COUNTR1Y (ECTYO): Country of residence one year before survey

Columns 150/151

PAGE 1 OF 15

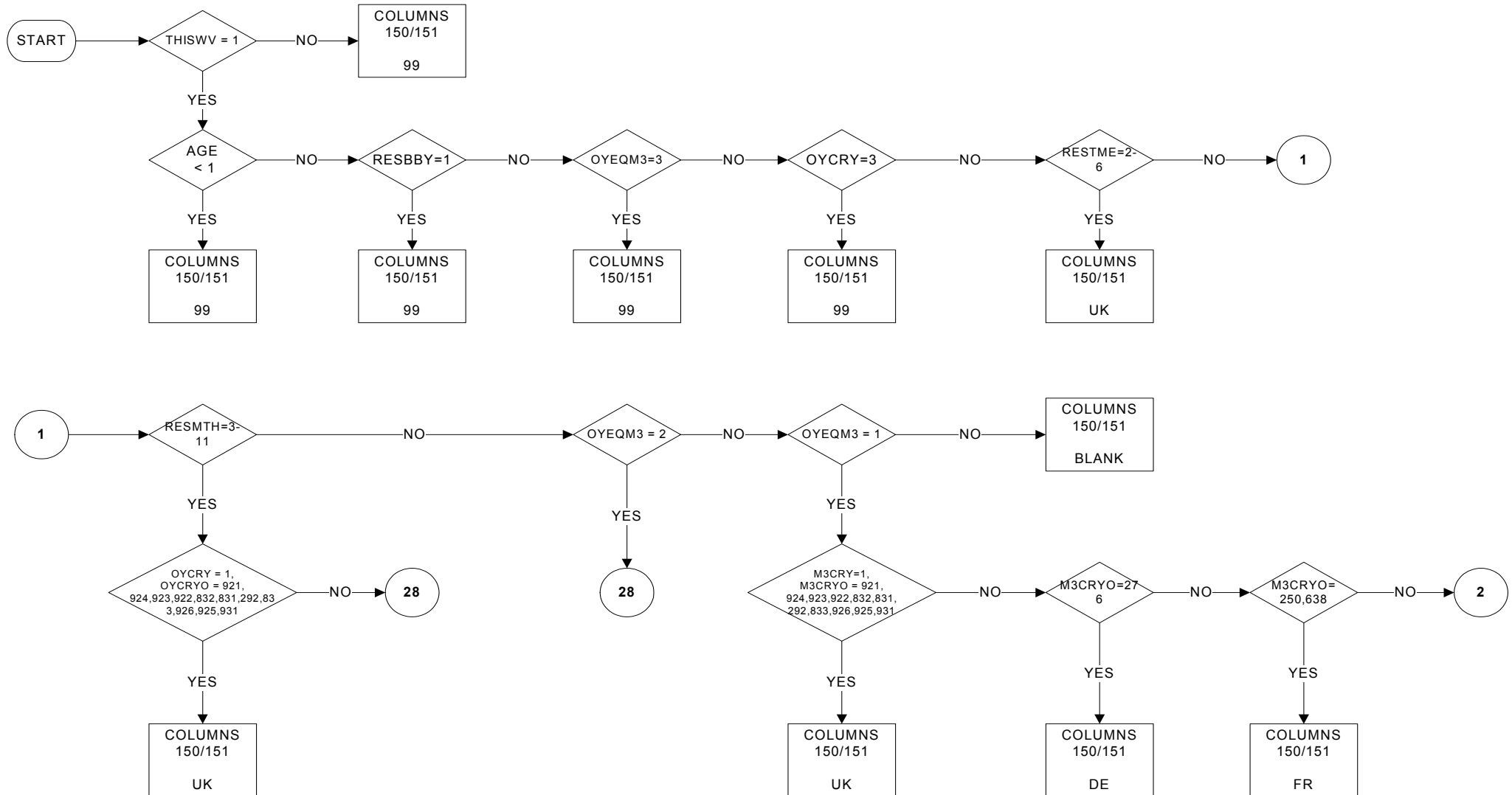

COUNTR1Y (ECTYO): Country of residence one year before survey

Columns 150/151

PAGE 2 OF 15

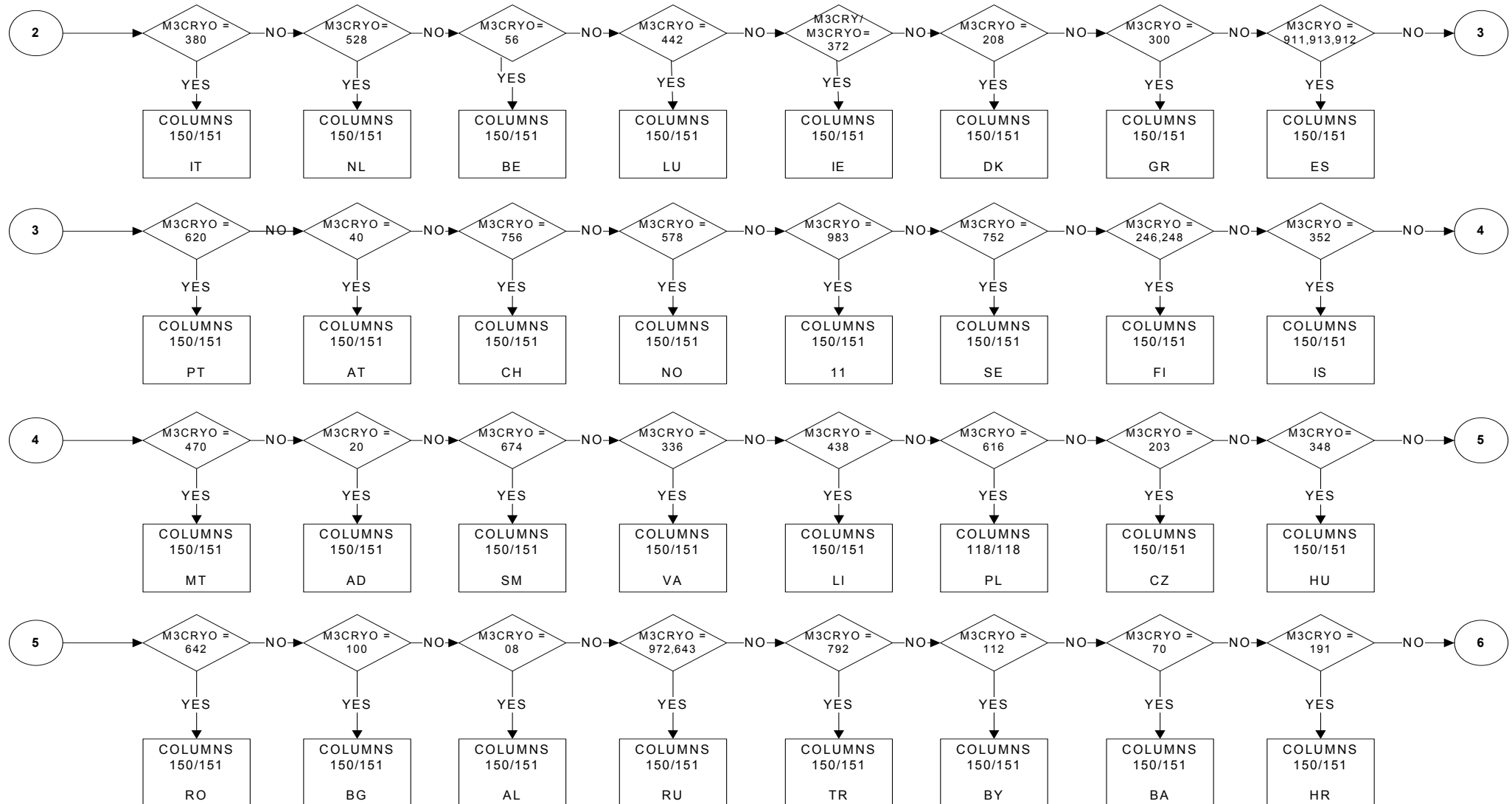

COUNTR1Y (ECTYO): Country of residence one year before survey

Columns 150/151

PAGE 3 OF 15

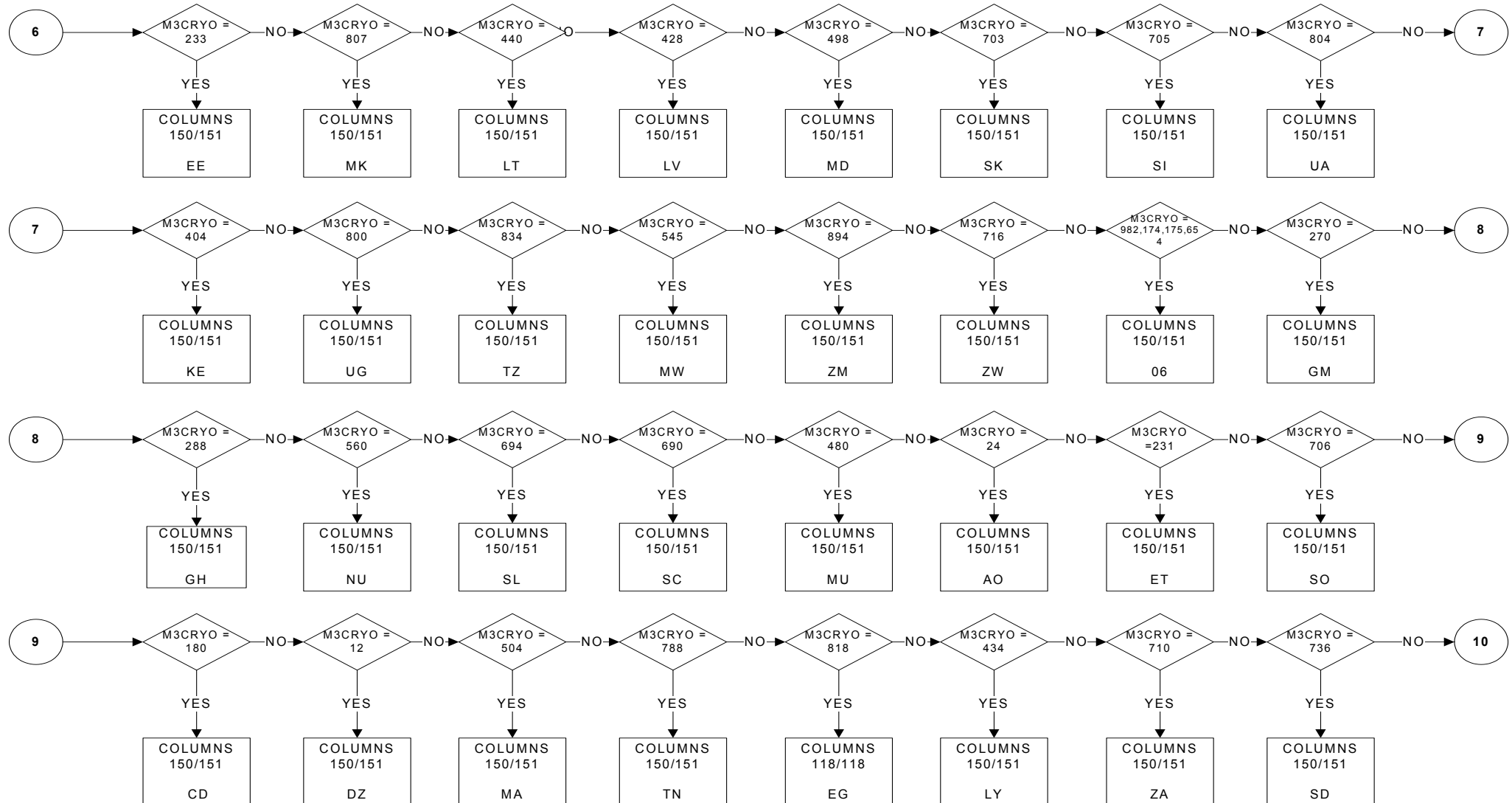

COUNTR1Y (ECTYO): Country of residence one year before survey

Columns 150/151

PAGE 4 OF 15

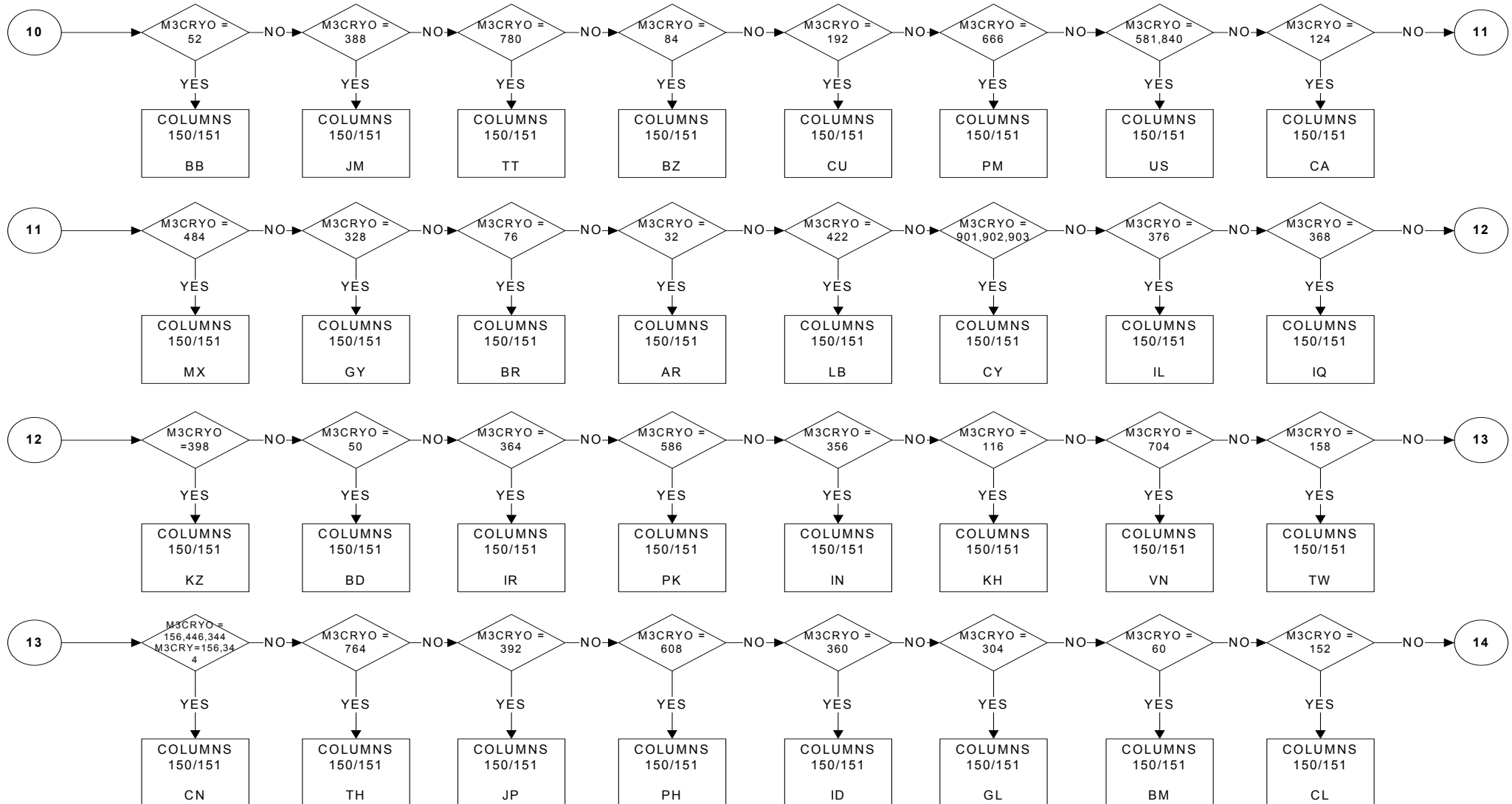

COUNTR1Y (ECTYO): Country of residence one year before survey

Columns 150/151

PAGE 5 OF 15

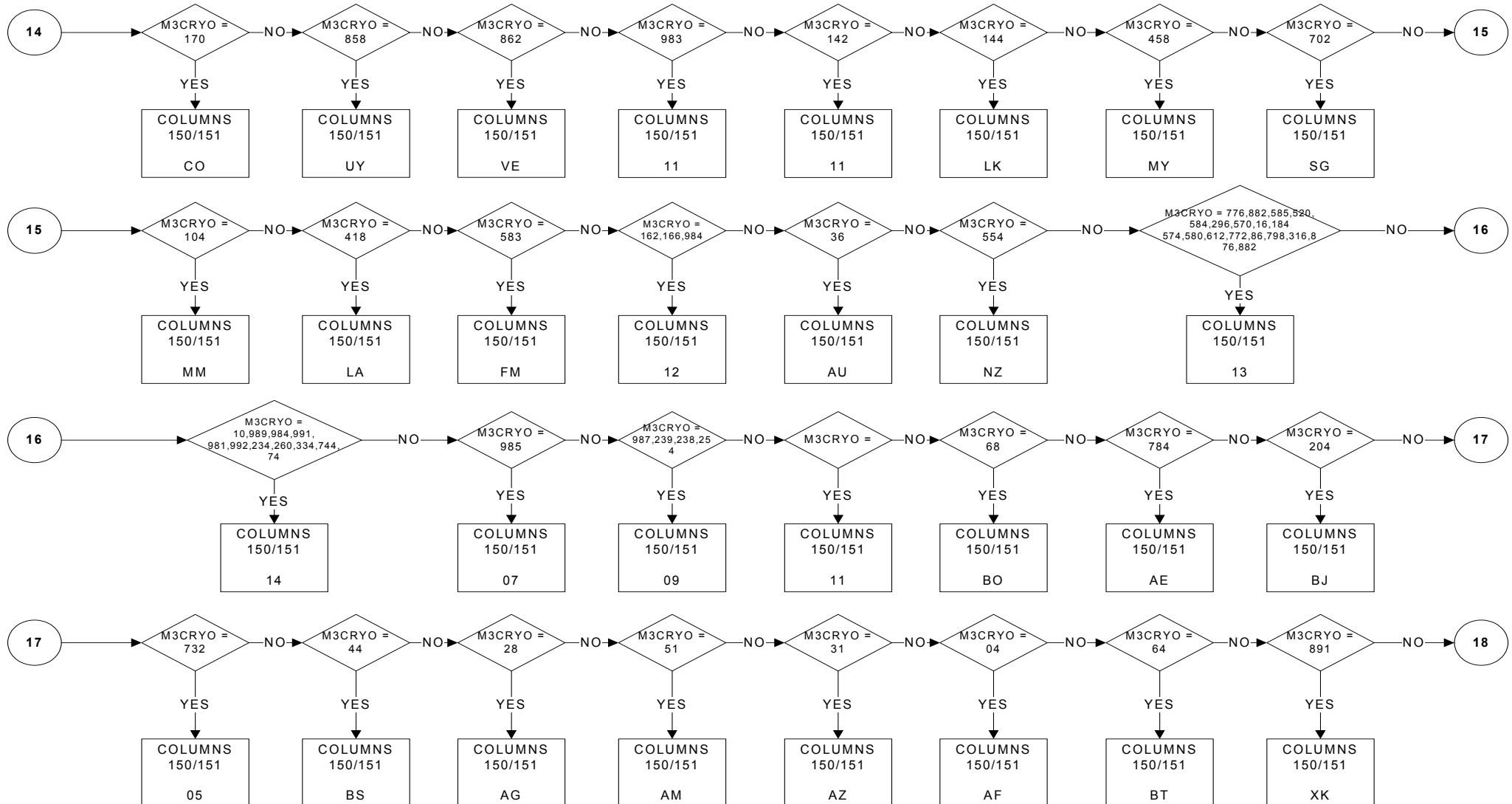

COUNTR1Y (ECTYO): Country of residence one year before survey

Columns 150/151

PAGE 6 OF 15

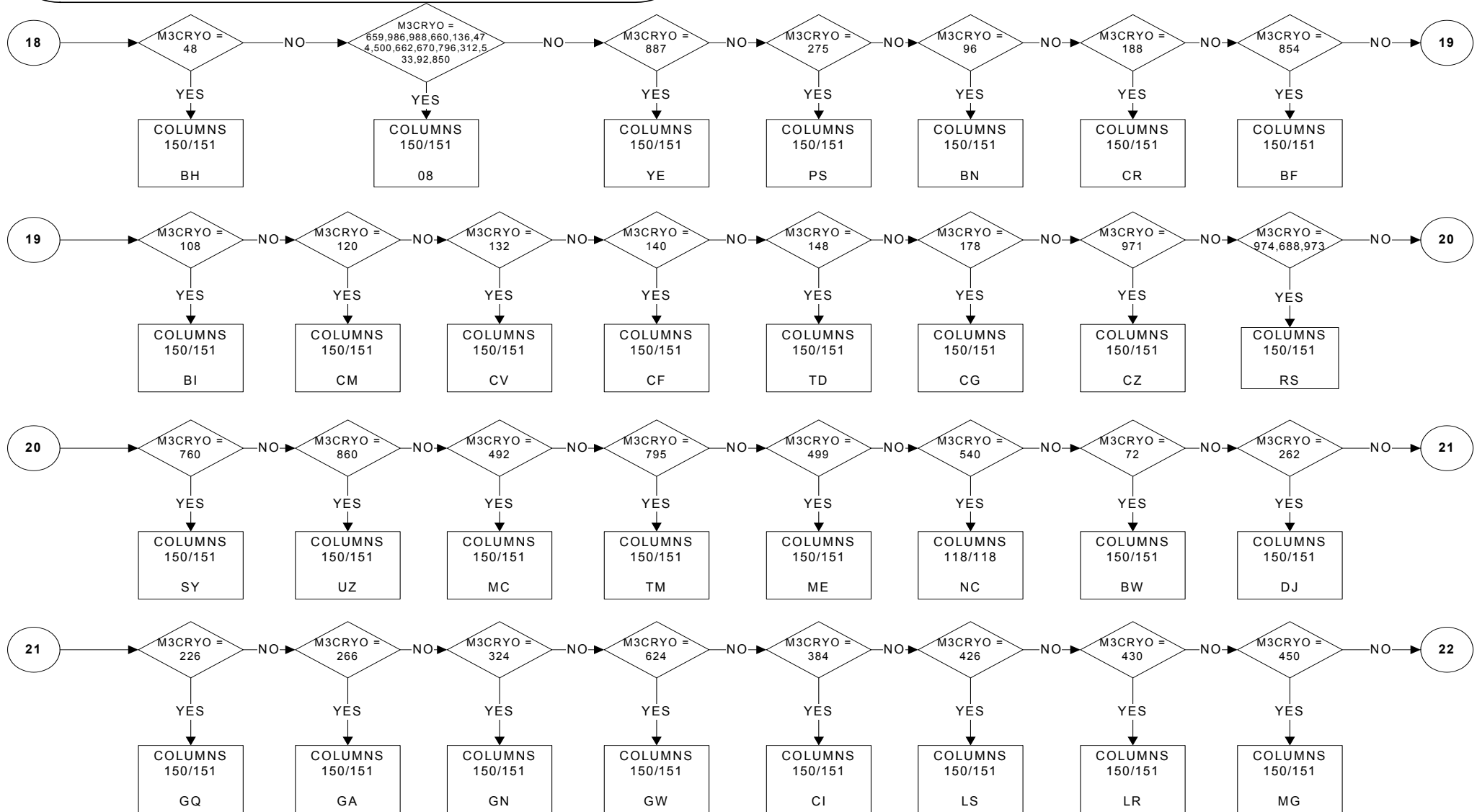

COUNTR1Y (ECTYO): Country of residence one year before survey

Columns 150/151

PAGE 7 OF 15

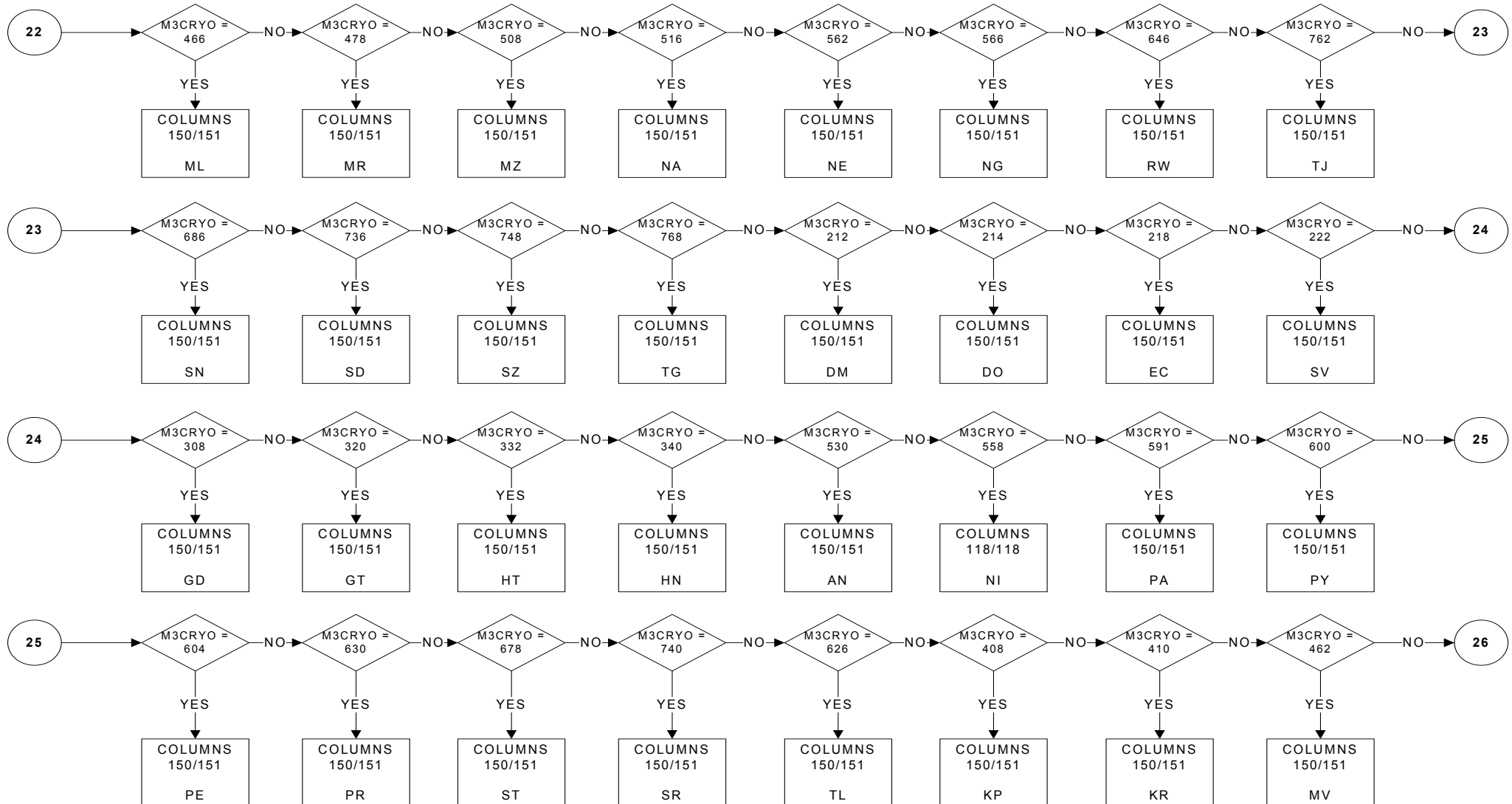

COUNTR1Y (ECTYO): Country of residence one year before survey

Columns 150/151

PAGE 8 OF 15

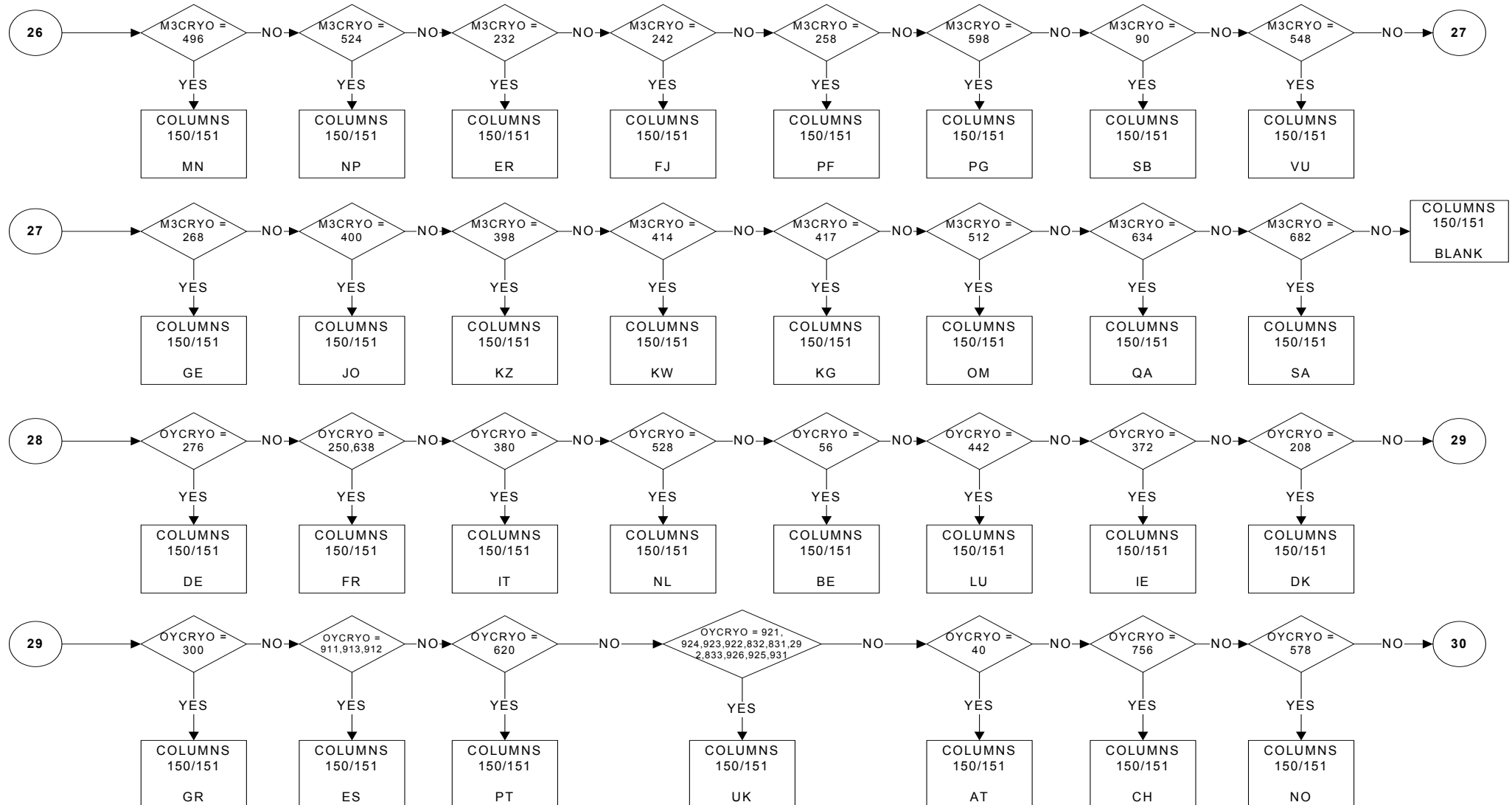

COUNTR1Y (ECTYO): Country of residence one year before survey

Columns 150/151

PAGE 9 OF 15

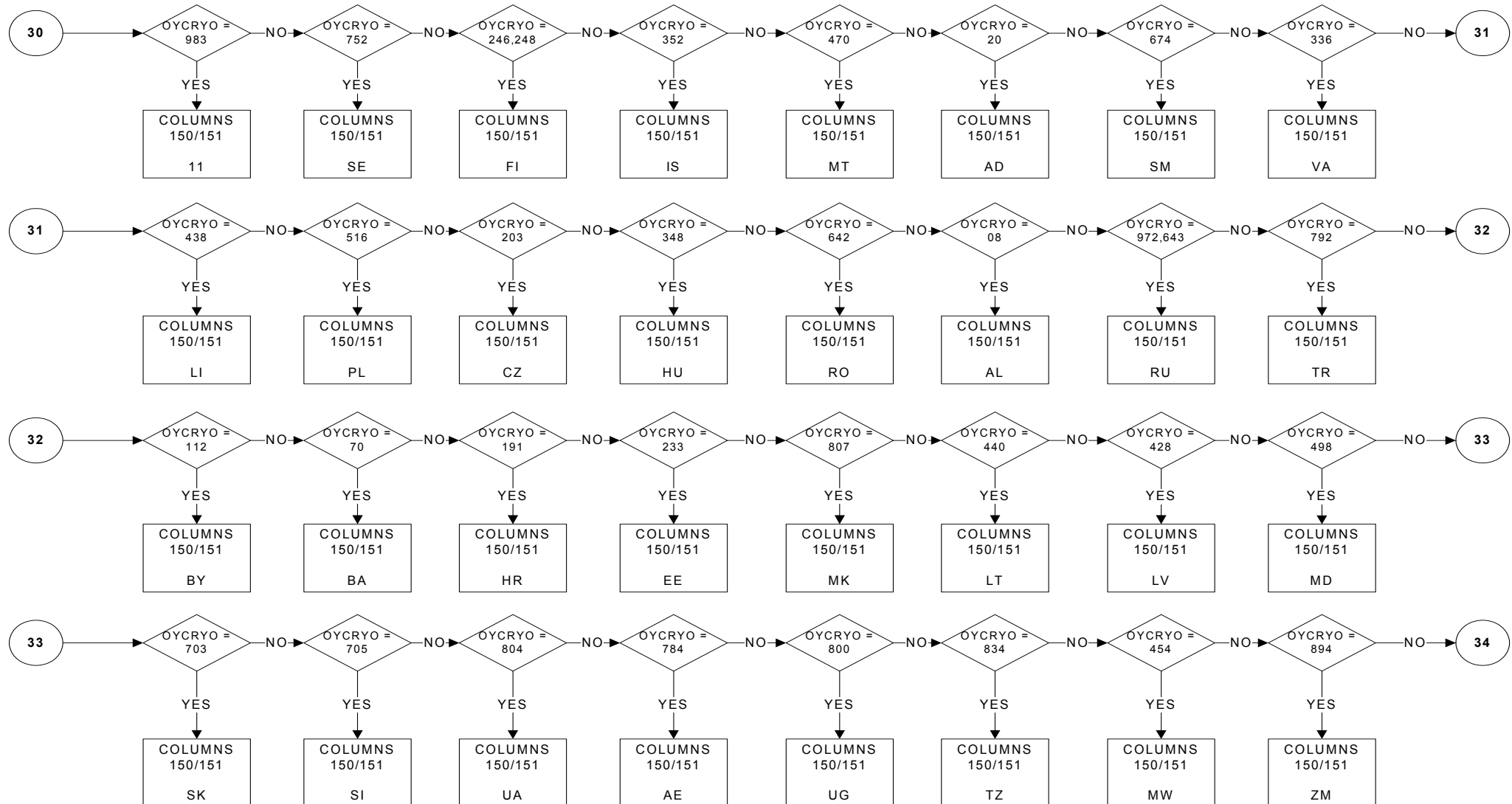

COUNTR1Y (ECTYO): Country of residence one year before survey

Columns 150/151

PAGE 10 OF 15

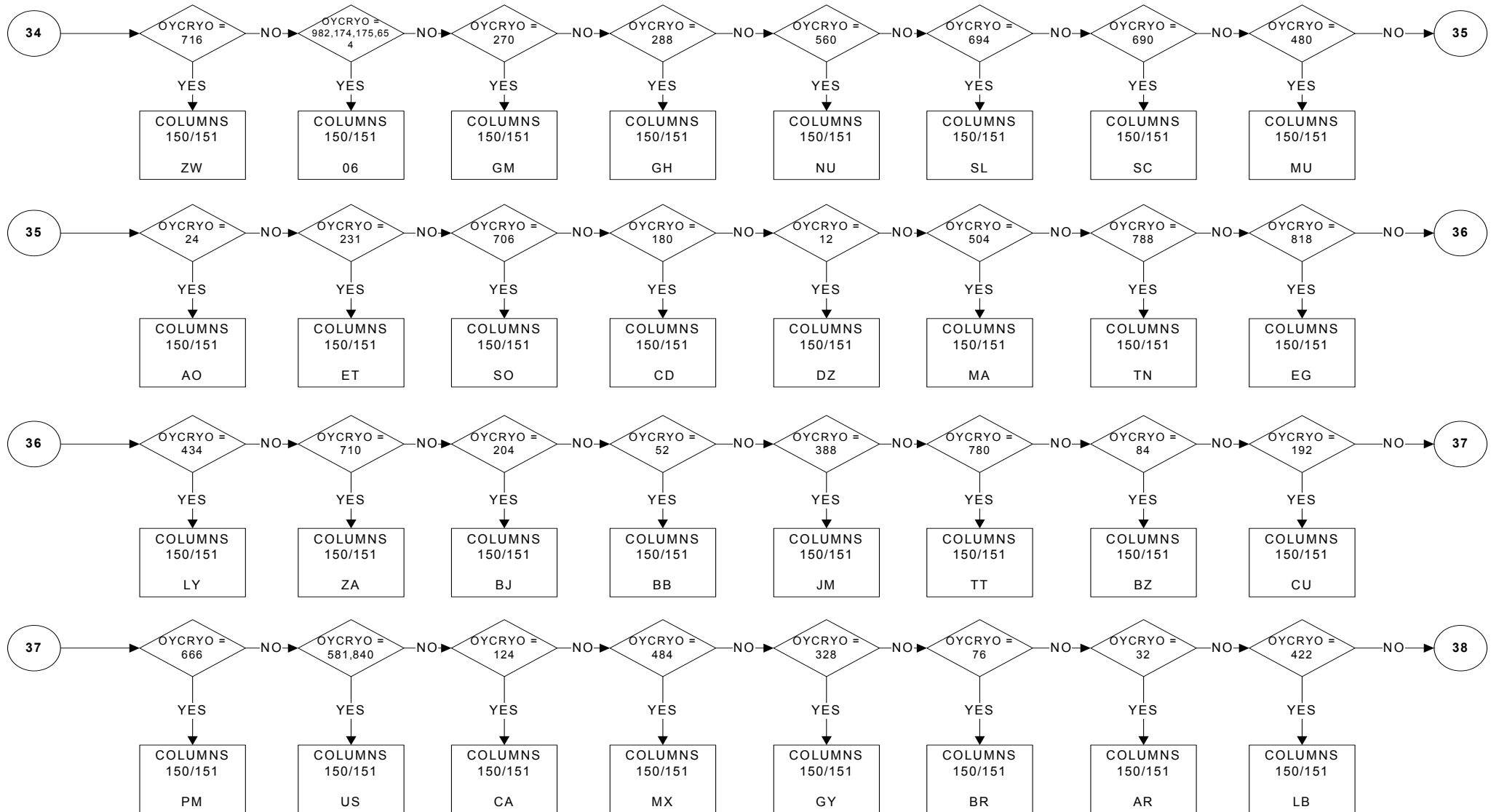

COUNTR1Y (ECTYO): Country of residence one year before survey

Columns 150/151

PAGE 11 OF 15

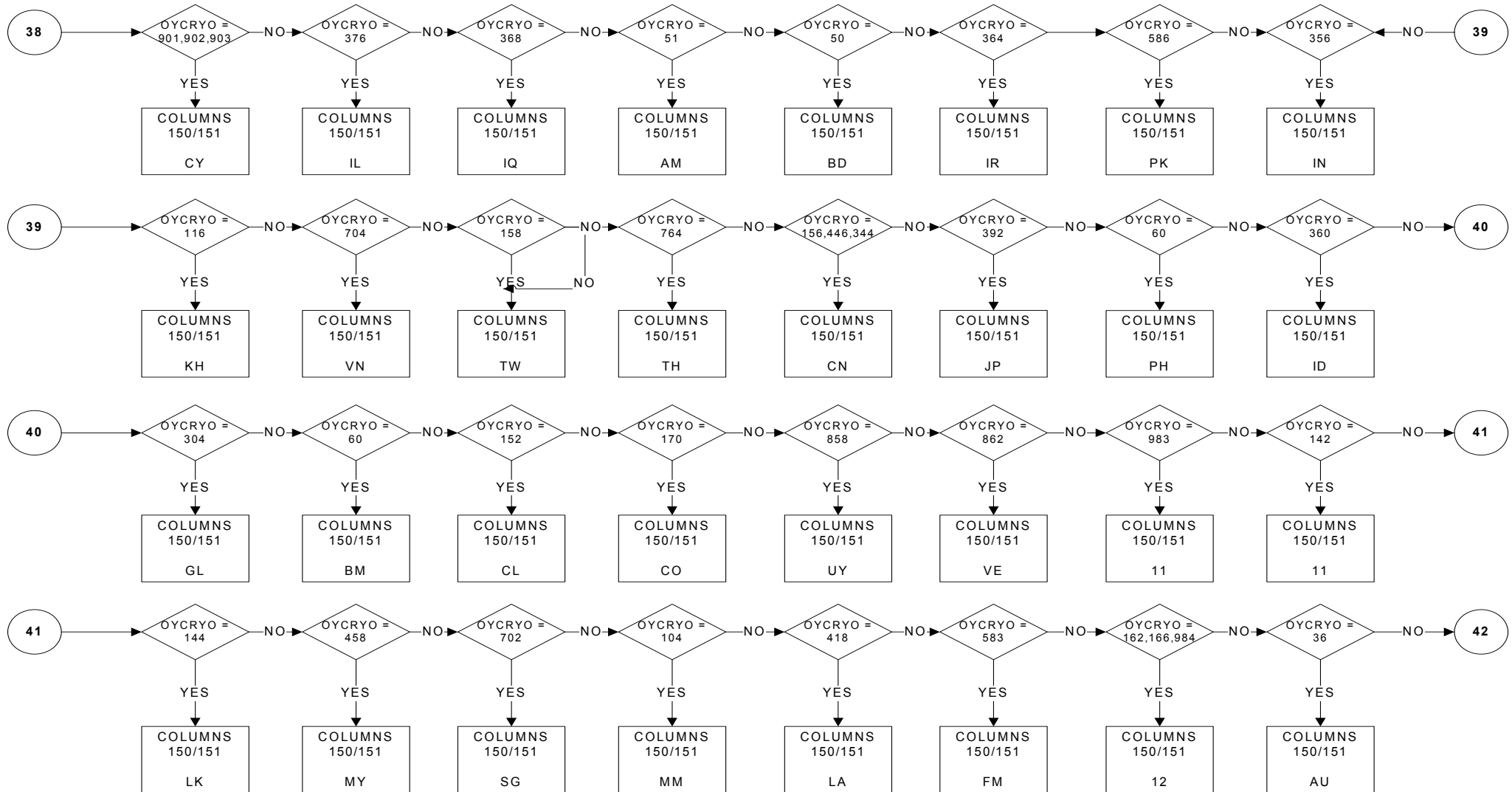

COUNTR1Y (ECTYO): Country of residence one year before survey

Columns 150/151

PAGE 12 OF 15

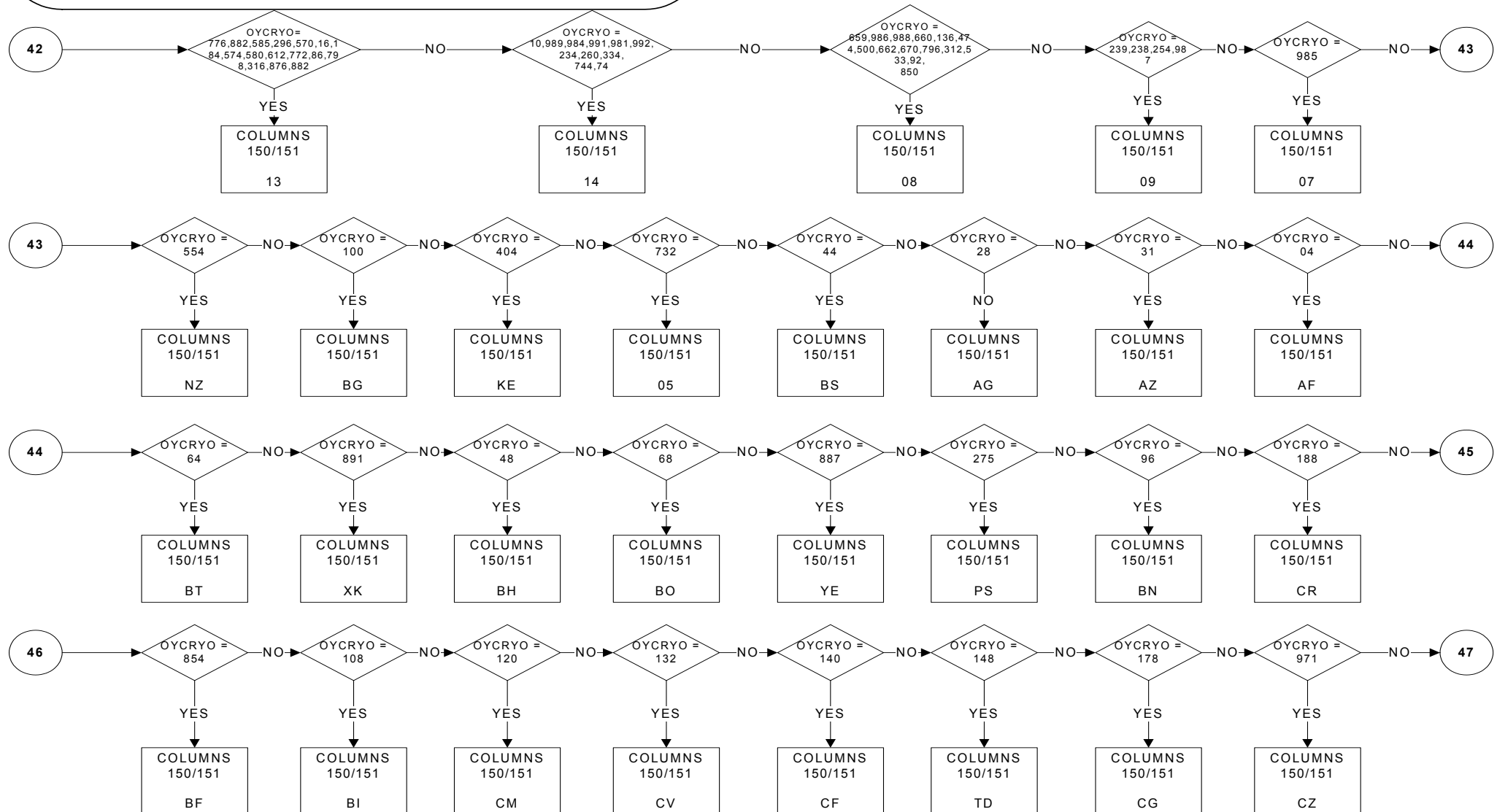

COUNTR1Y (ECTYO): Country of residence one year before survey

Columns 150/151

PAGE 13 OF 15

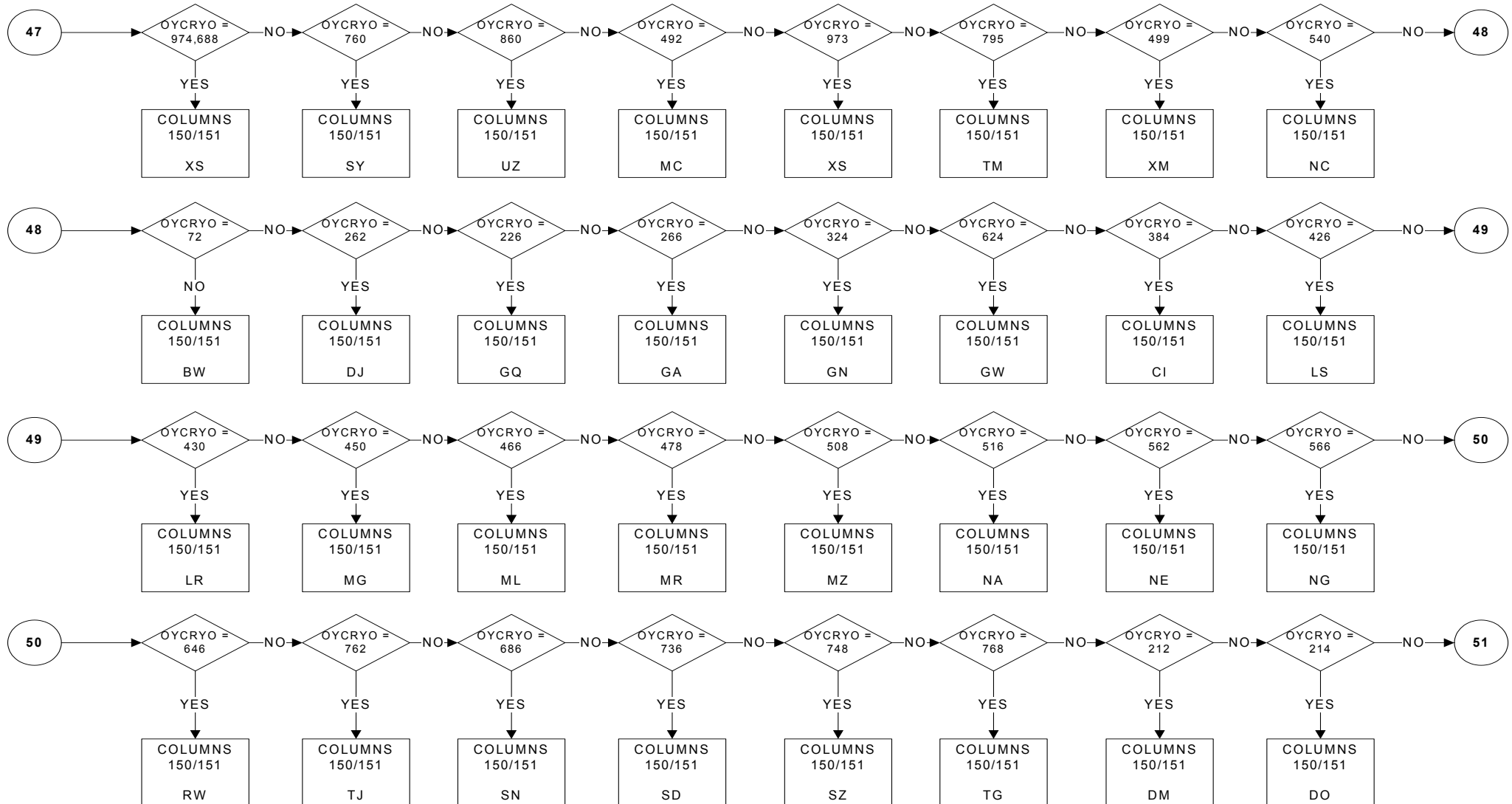

COUNTR1Y (ECTYO): Country of residence one year before survey

Columns 150/151

PAGE 14 OF 15

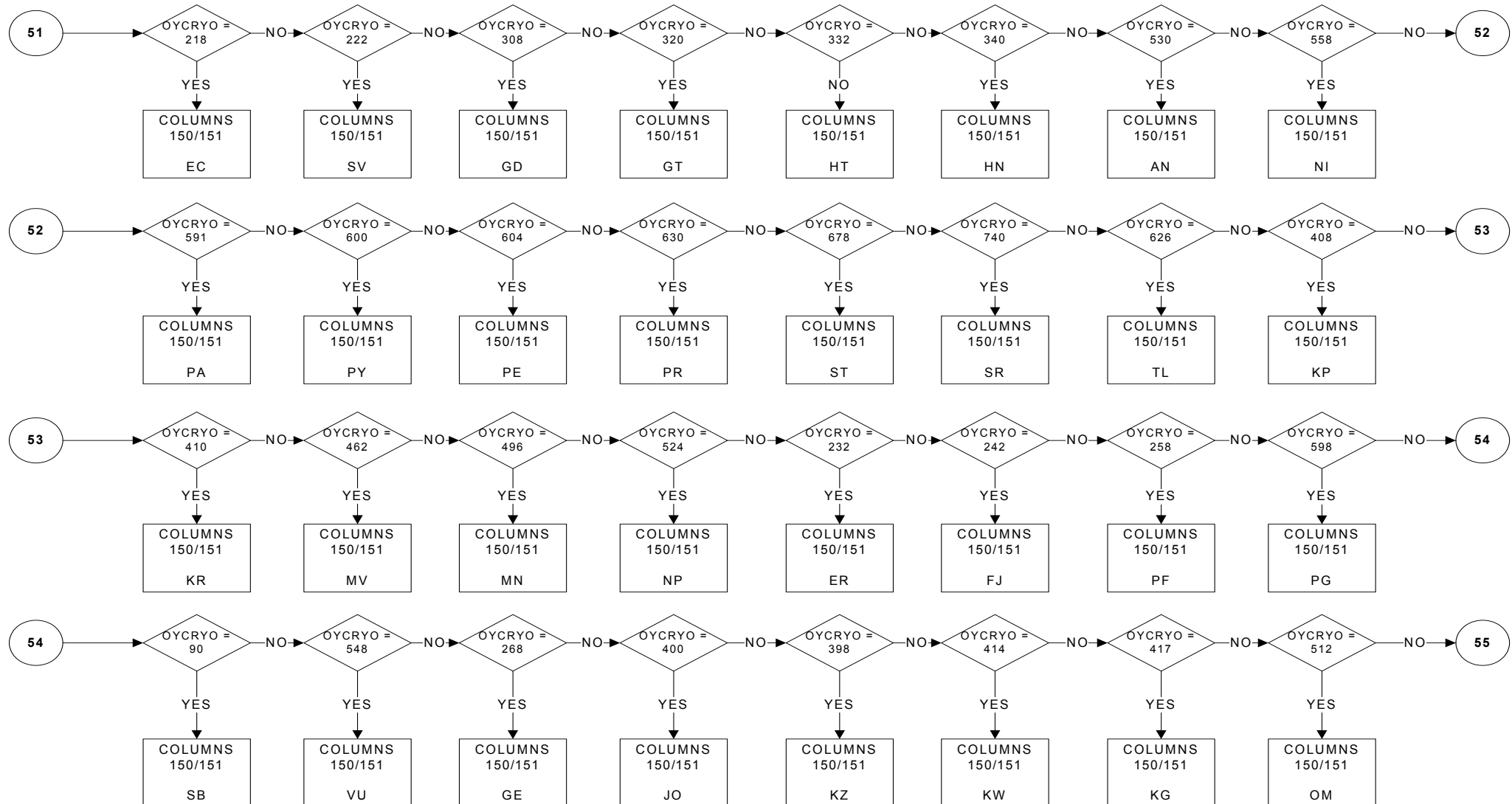

COUNTR1Y (ECTYO): Country of residence one year before survey

Columns 150/151

PAGE 15 OF 15

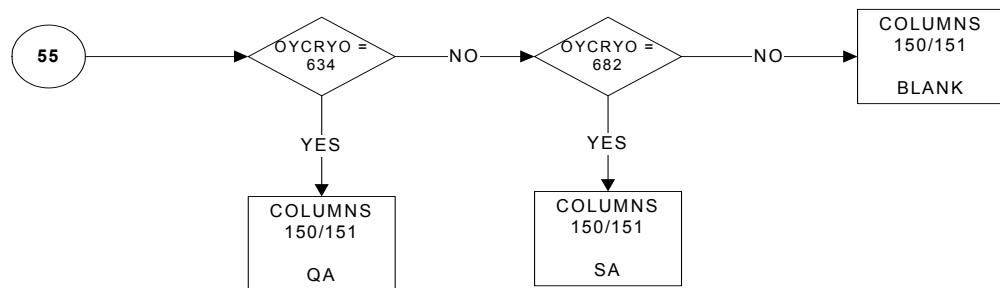

Key

99	Not Applicable (child less than one year old)
Blank	No Answer

REGION1Y (EREG00): Region of residence one year before survey

Column 152/153

PAGE 1 OF 1

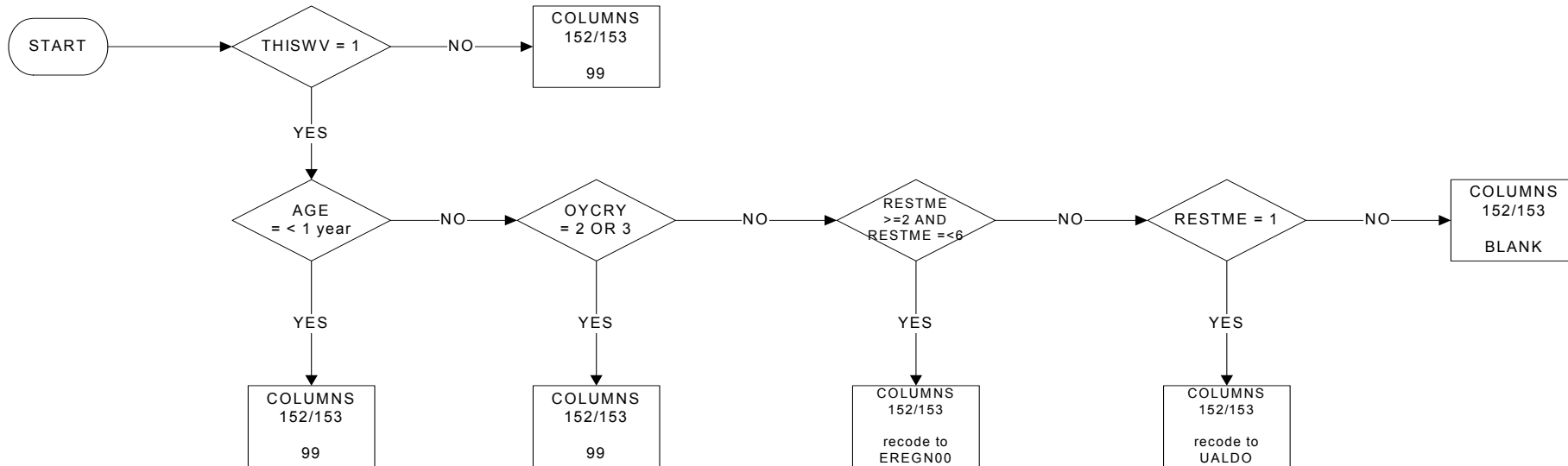

KEY

99 Not applicable (person who has changed country of residence or child less than one year old)
 BLANK No answer

ENTMNDC: Monthly net (take home) pay from main job

Columns 154/155

PAGE 1 OF 15

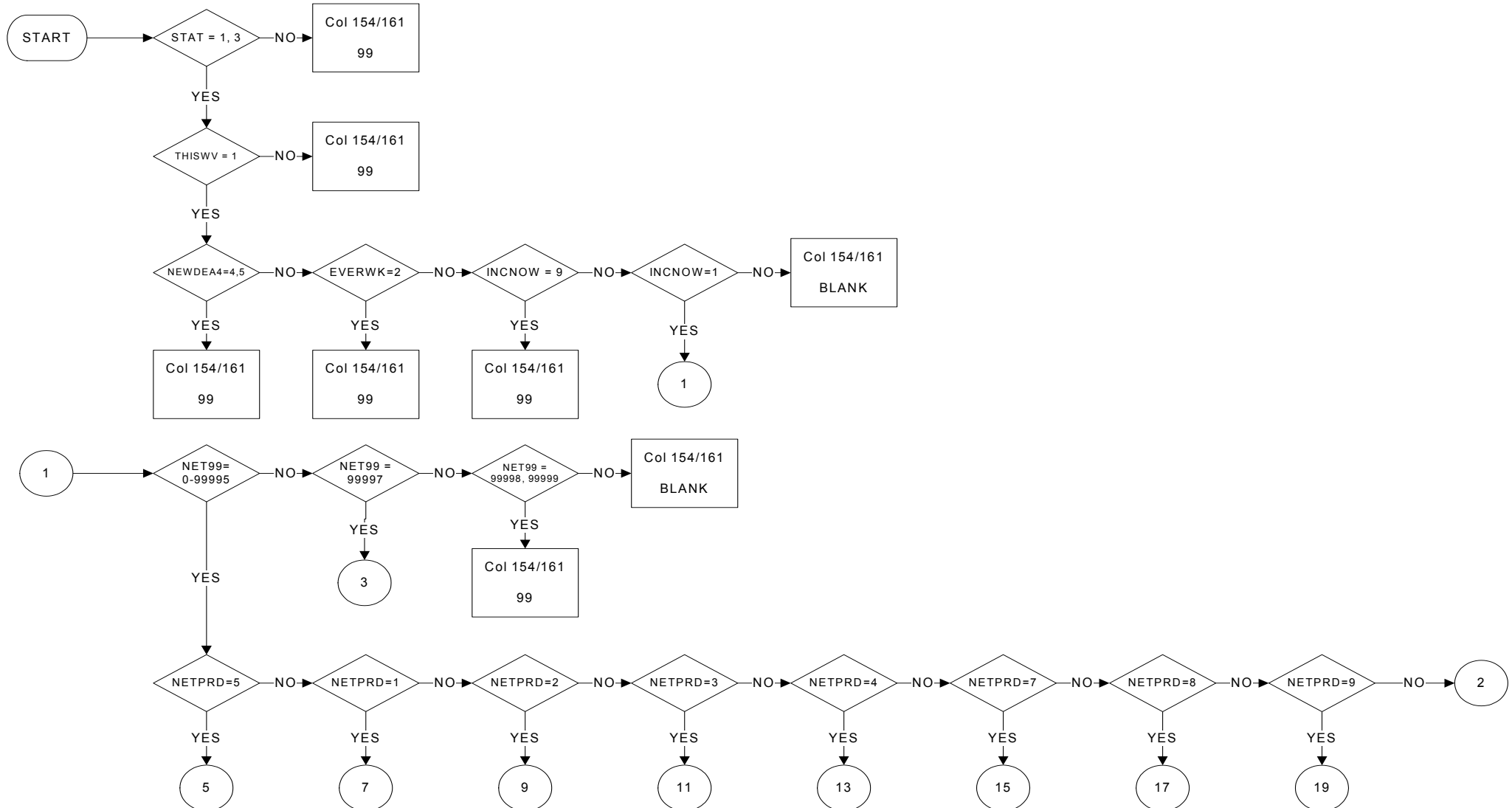

ENTMND: Monthly net (take home) pay from main job

Columns 154/155

PAGE 2 OF 15

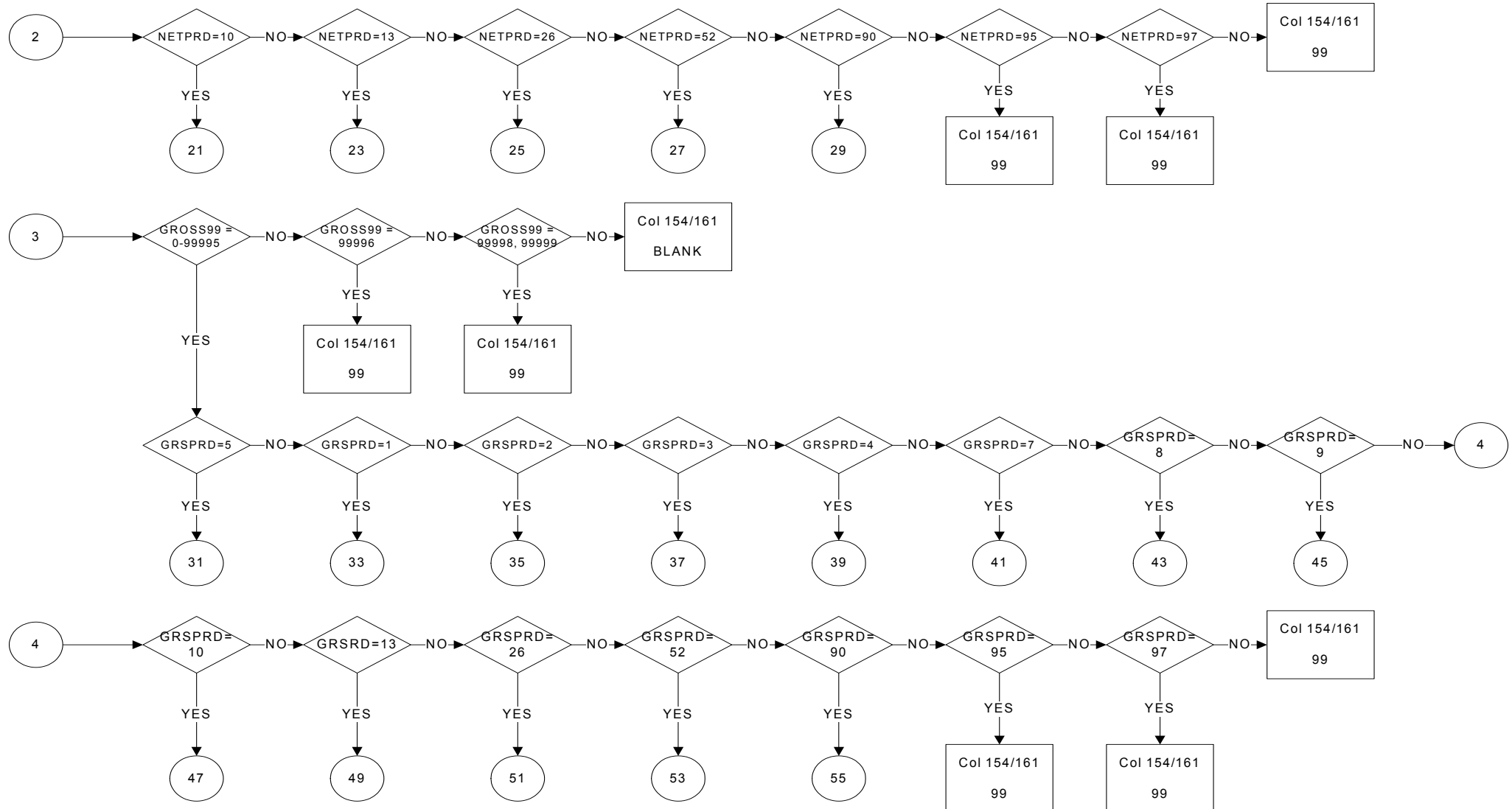

ENTMND: Monthly net (take home) pay from main job

Columns 154/155

PAGE 3 OF 15

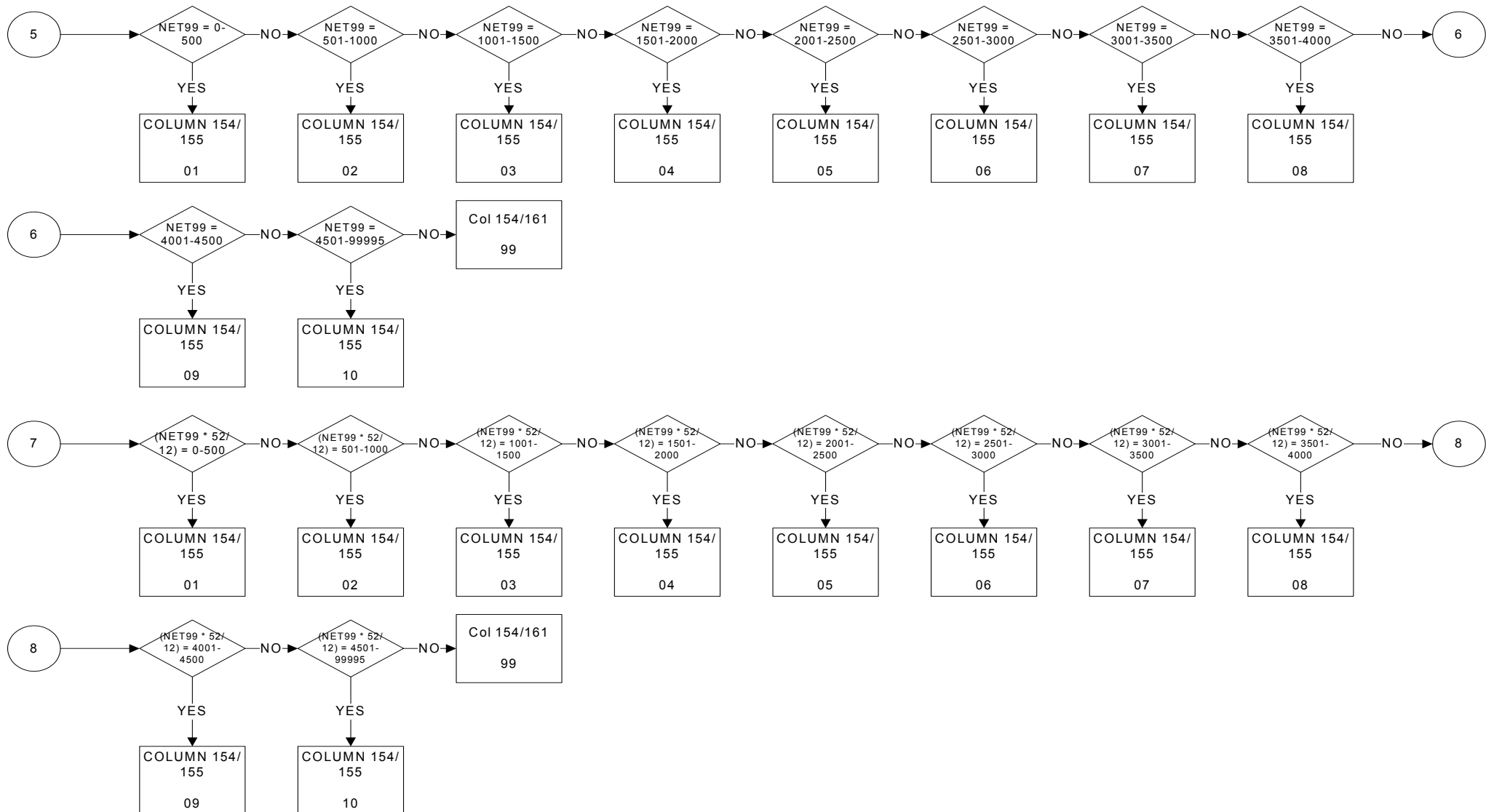

ENTMND: Monthly net (take home) pay from main job

Columns 154/155

PAGE 4 OF 15

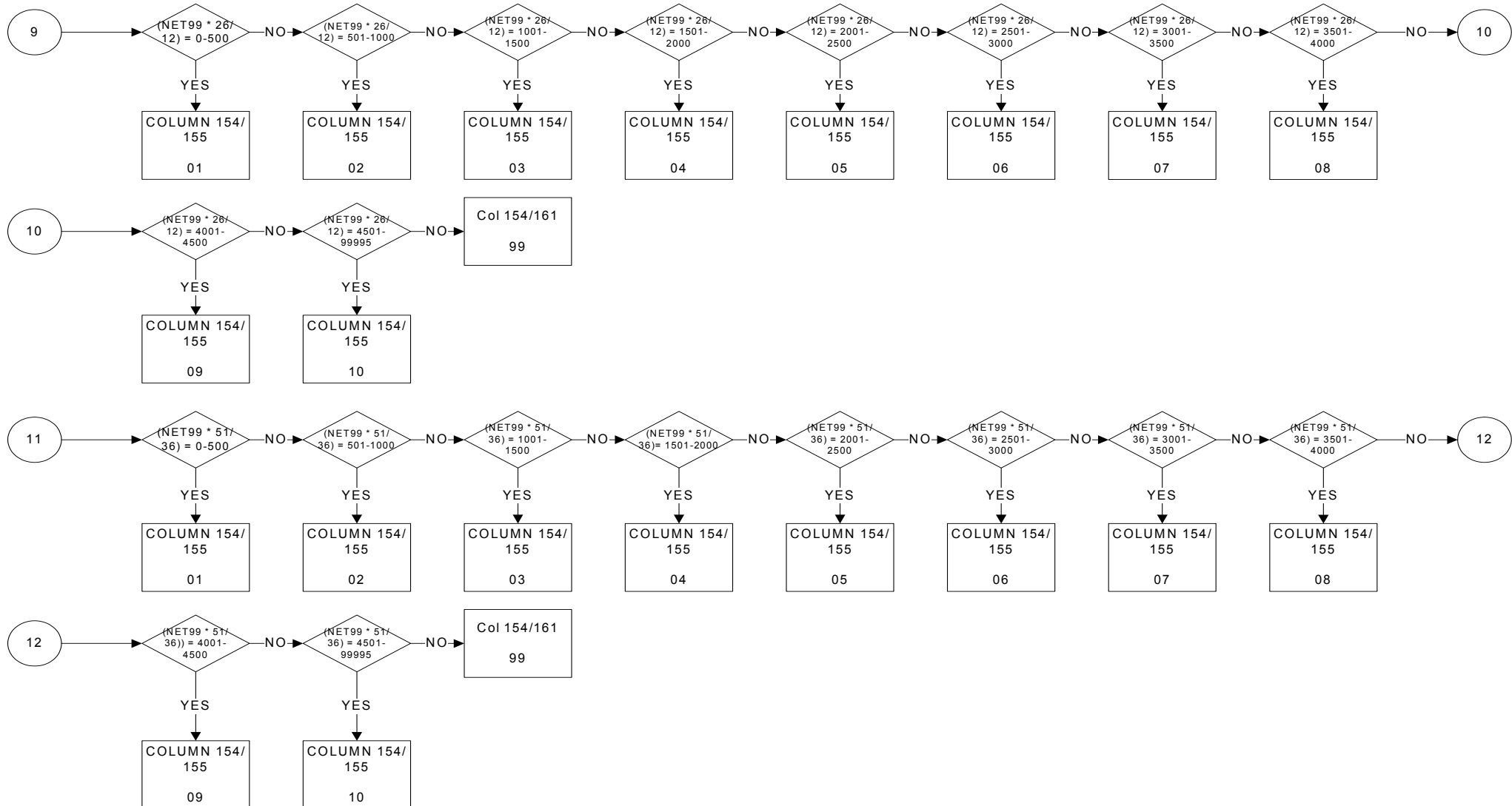

ENTMND: Monthly net (take home) pay from main job

Columns 154/155

PAGE 5 OF 15

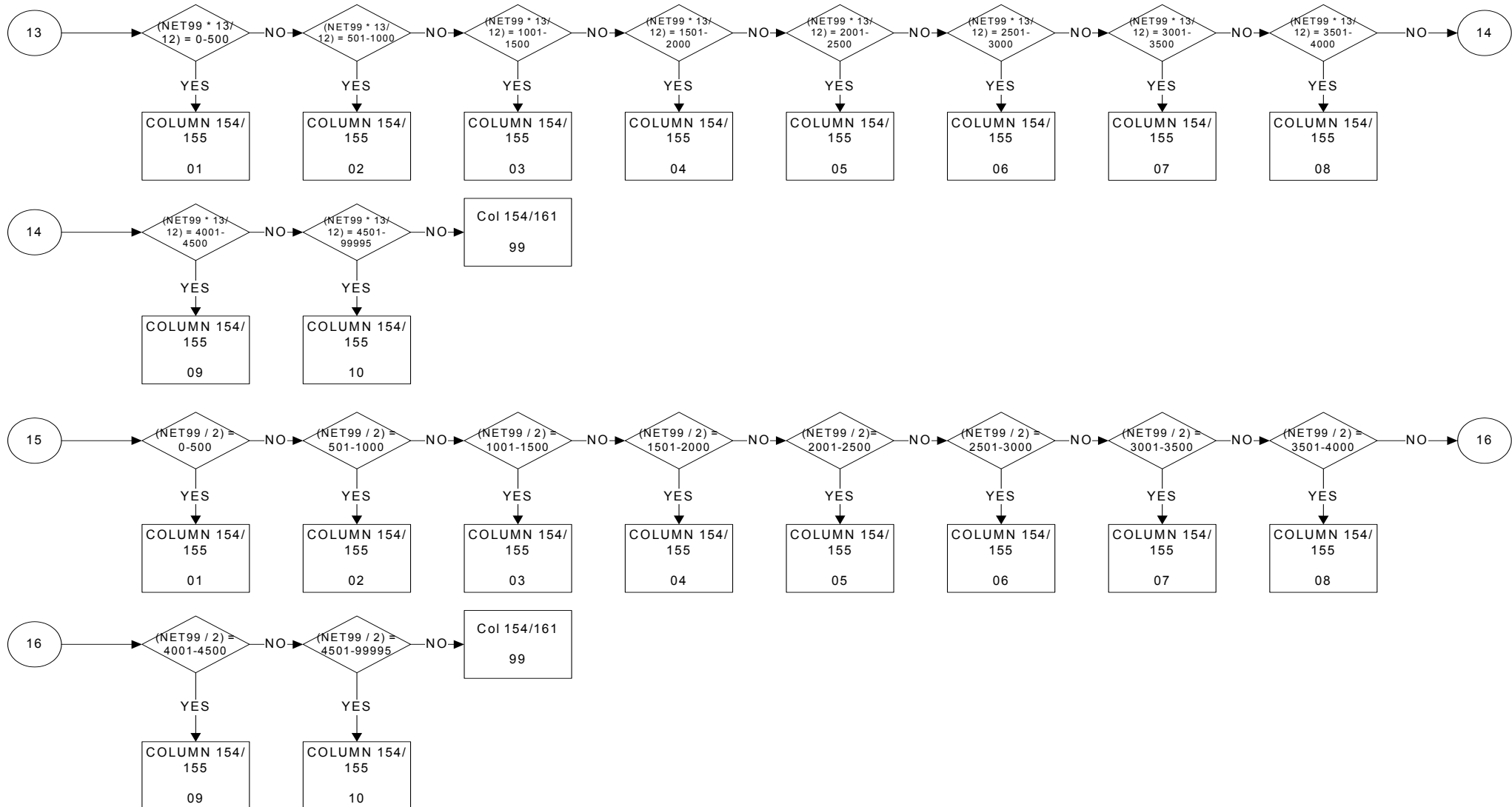

ENTMND: Monthly net (take home) pay from main job

Columns 154/155

PAGE 6 OF 15

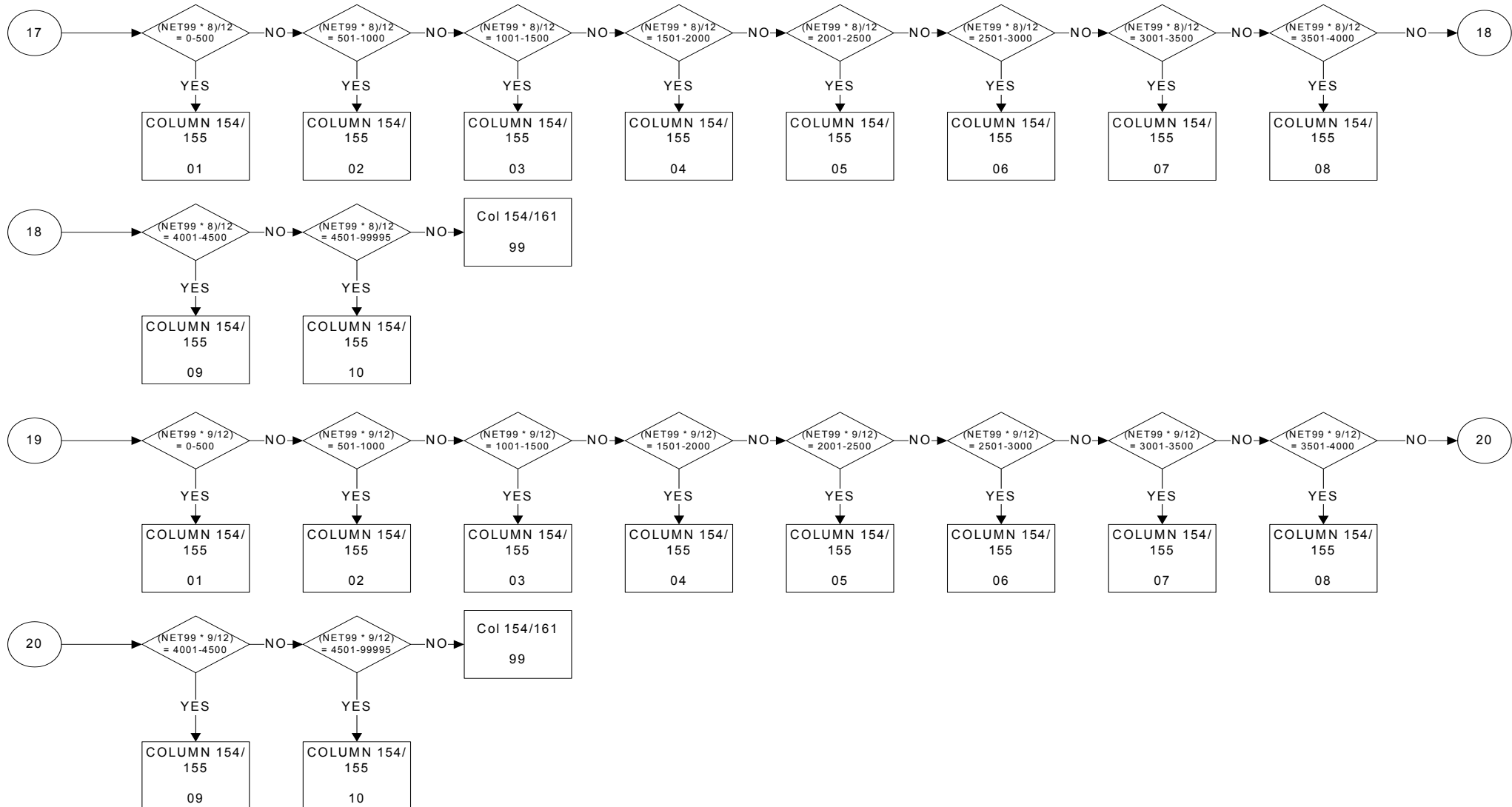

ENTMND: Monthly net (take home) pay from main job
 Columns 154/155
 PAGE 7 OF 15

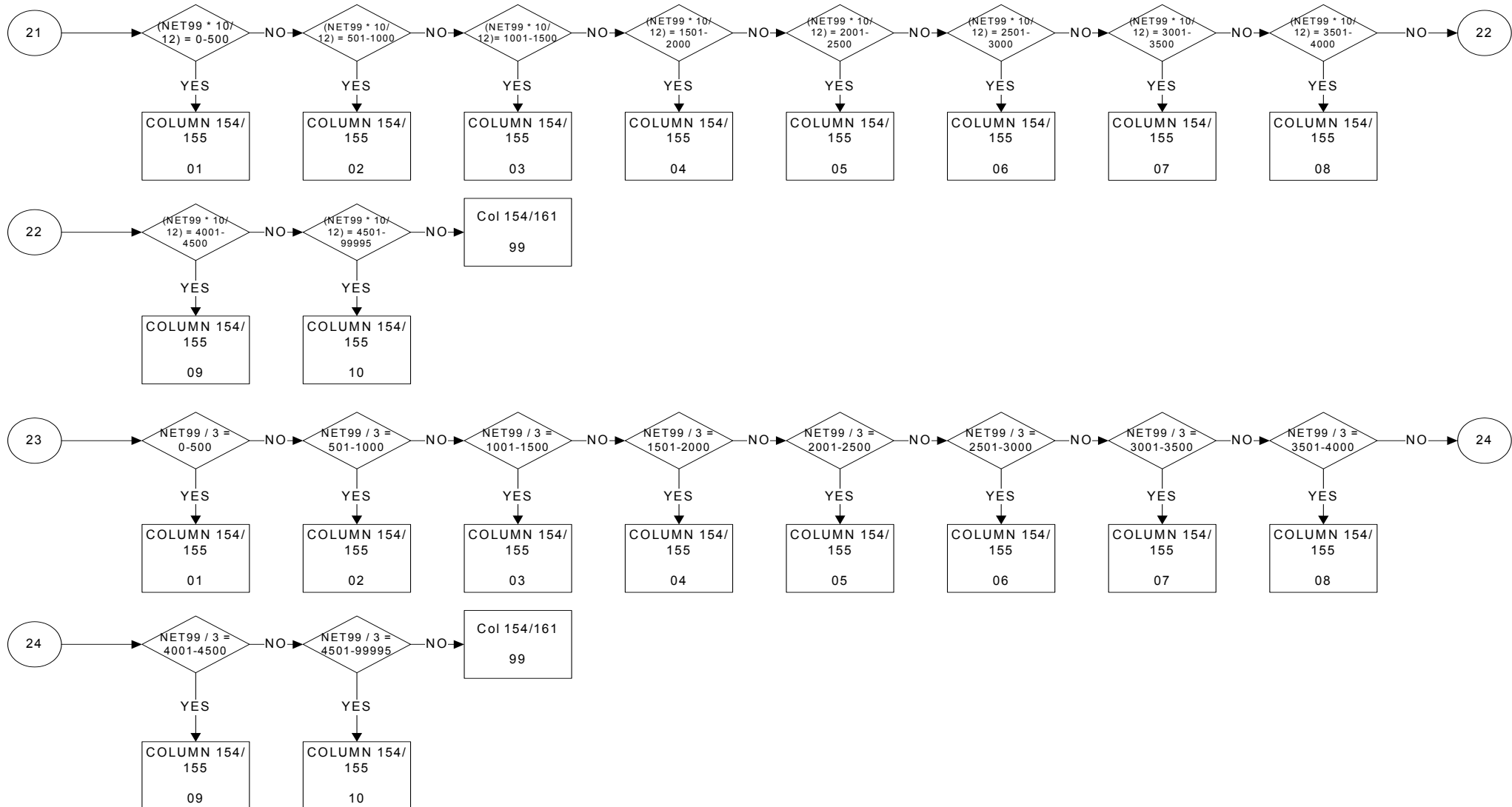

ENTMND: Monthly net (take home) pay from main job

Columns 154/155

PAGE 8 OF 15

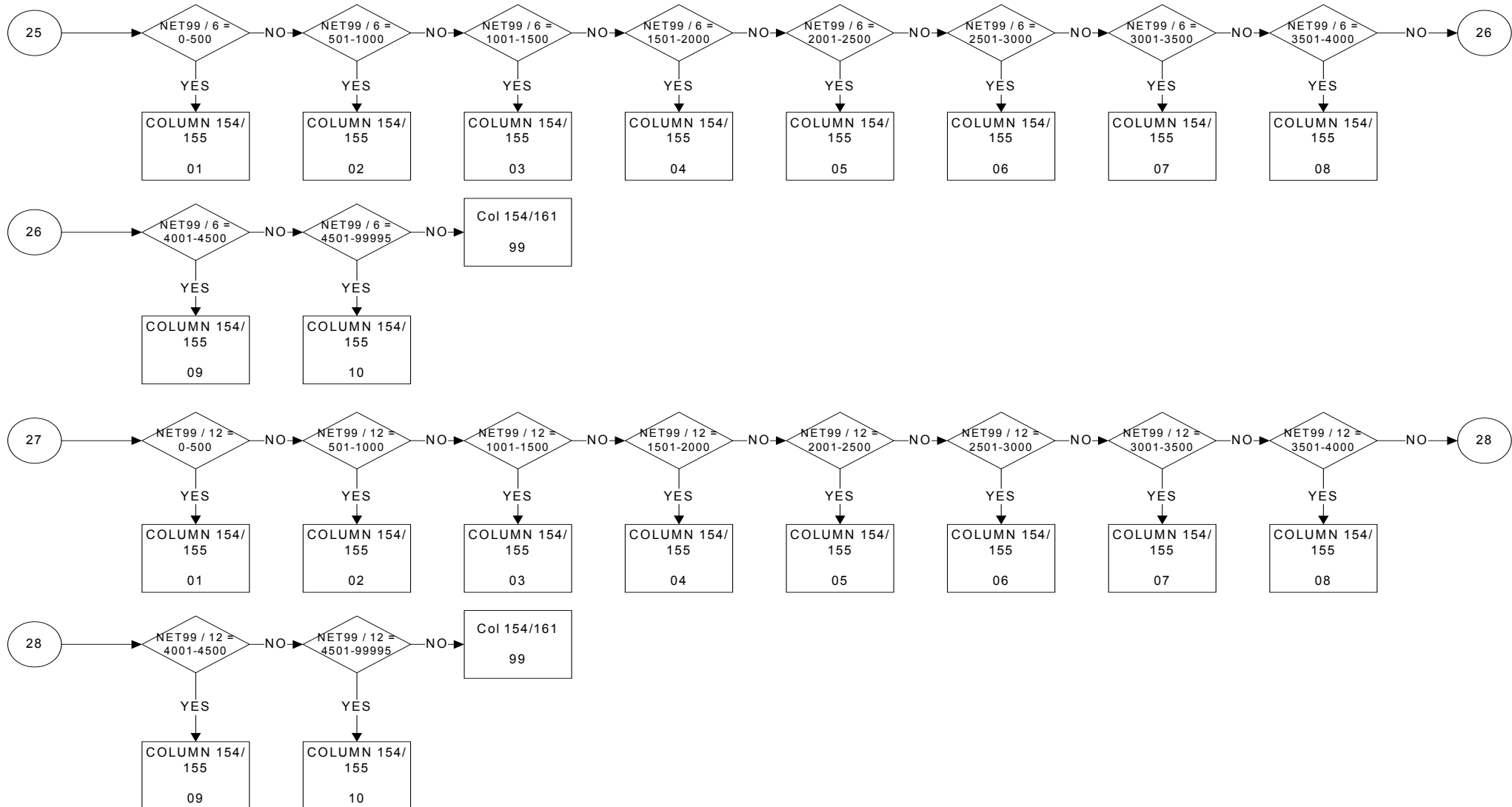

ENTMND: Monthly net (take home) pay from main job

Columns 154/155

PAGE 9 OF 15

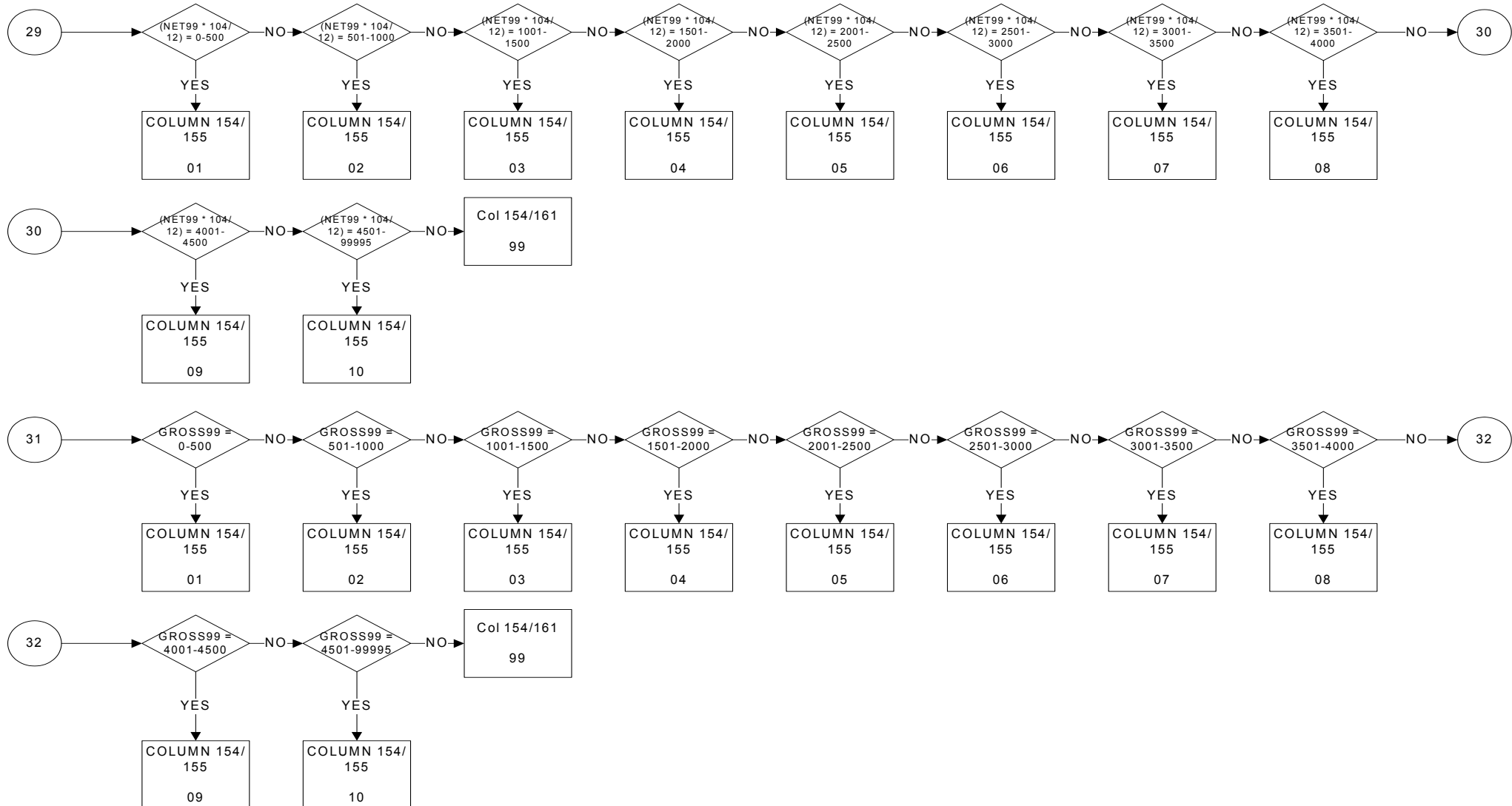

ENTMND: Monthly net (take home) pay from main job

Columns 154/155

PAGE 10 OF 15

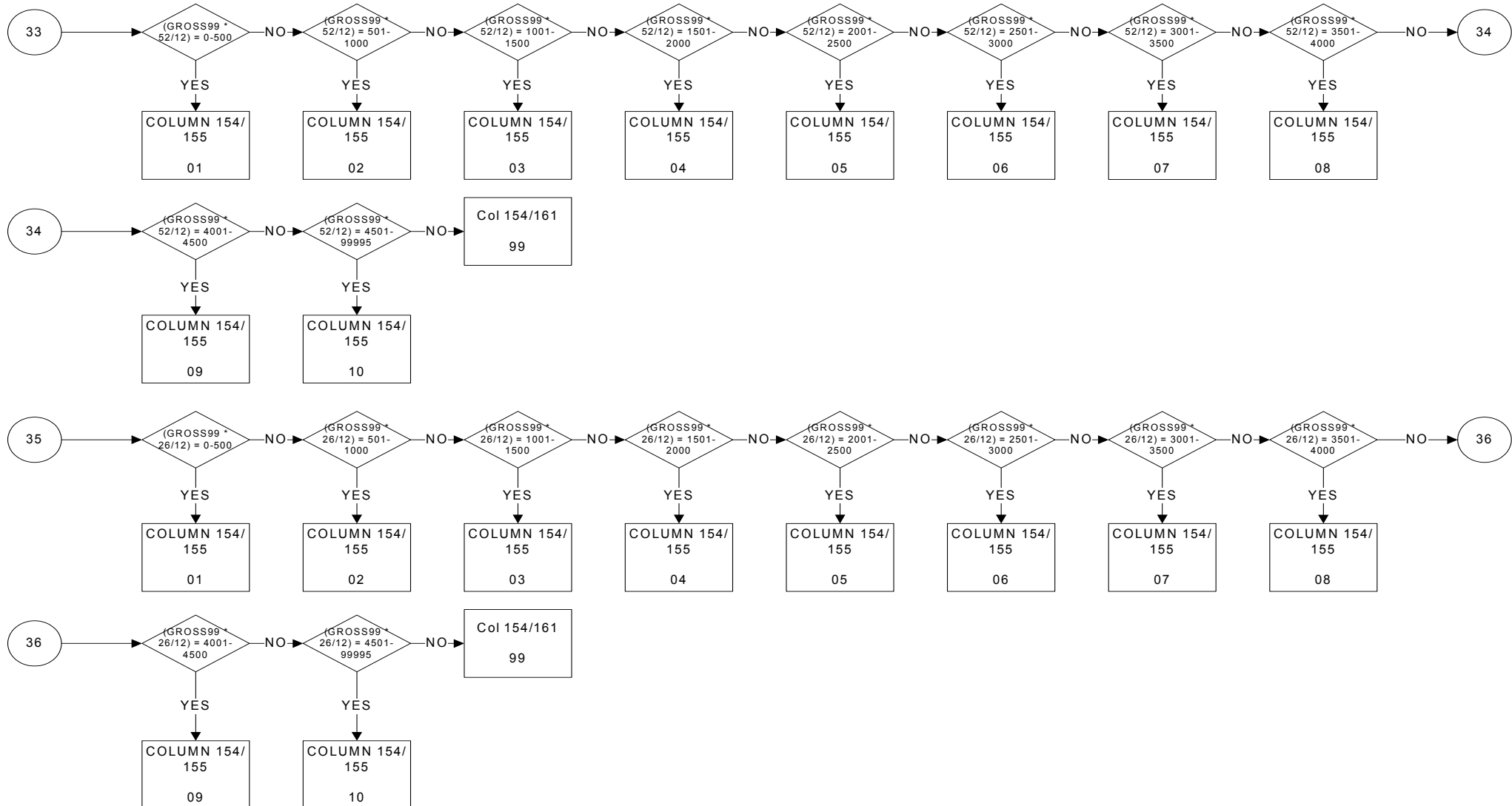

ENTMND: Monthly net (take home) pay from main job
 Columns 154/155
 PAGE 11 OF 15

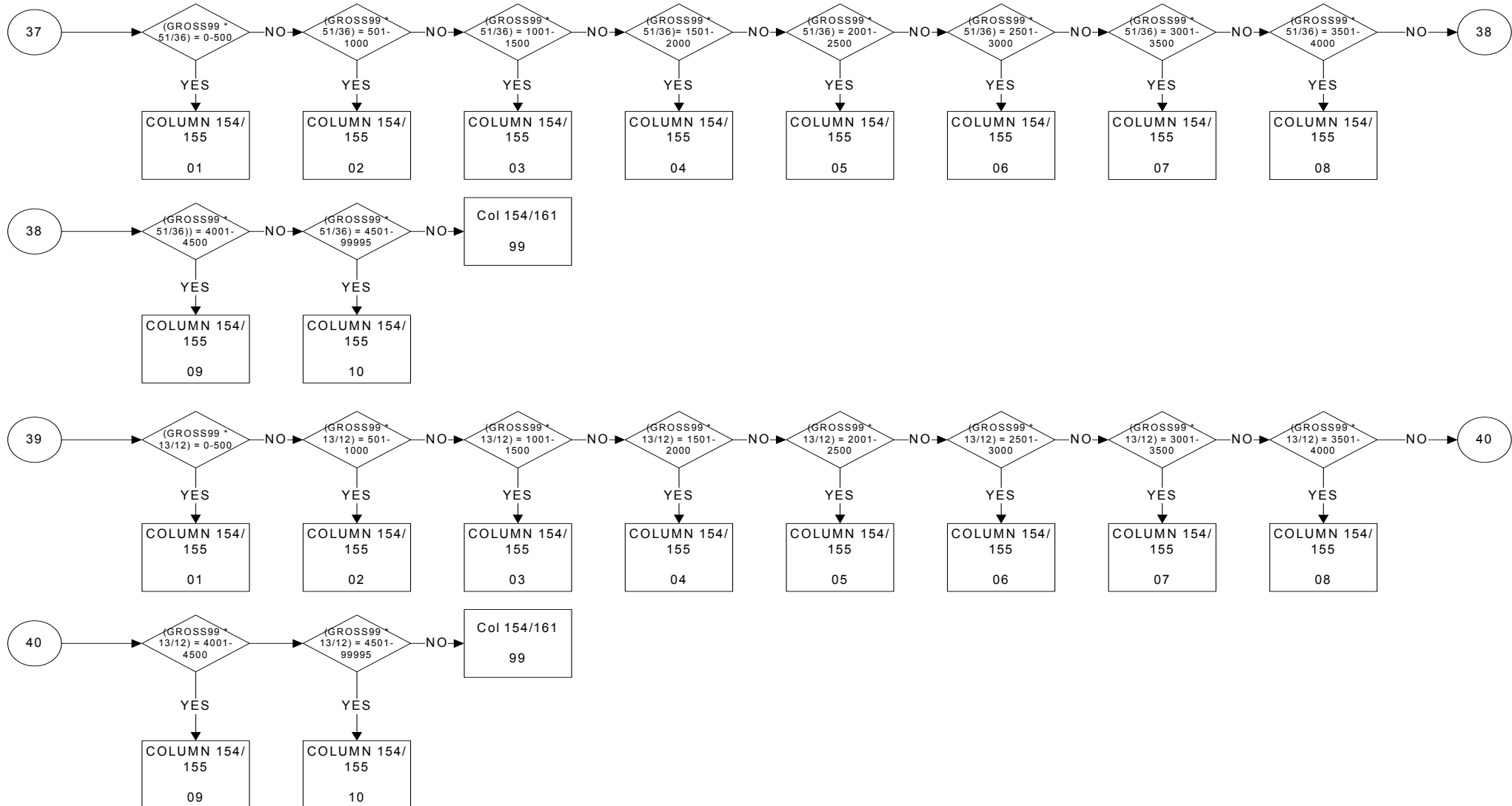

ENTMND: Monthly net (take home) pay from main job

Columns 154/155

PAGE 12 OF 15

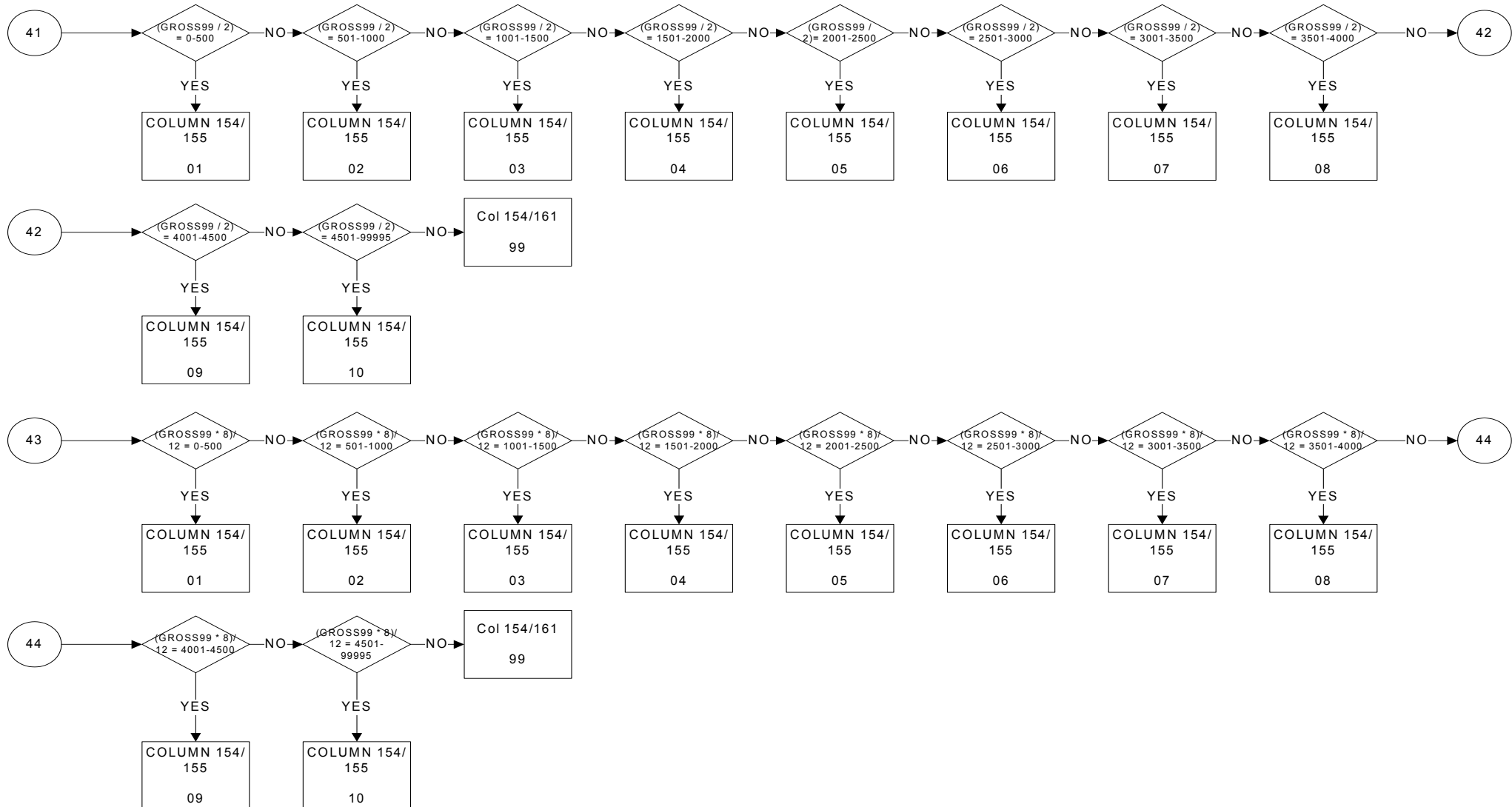

ENTMND: Monthly net (take home) pay from main job

Columns 154/155

PAGE 13 OF 15

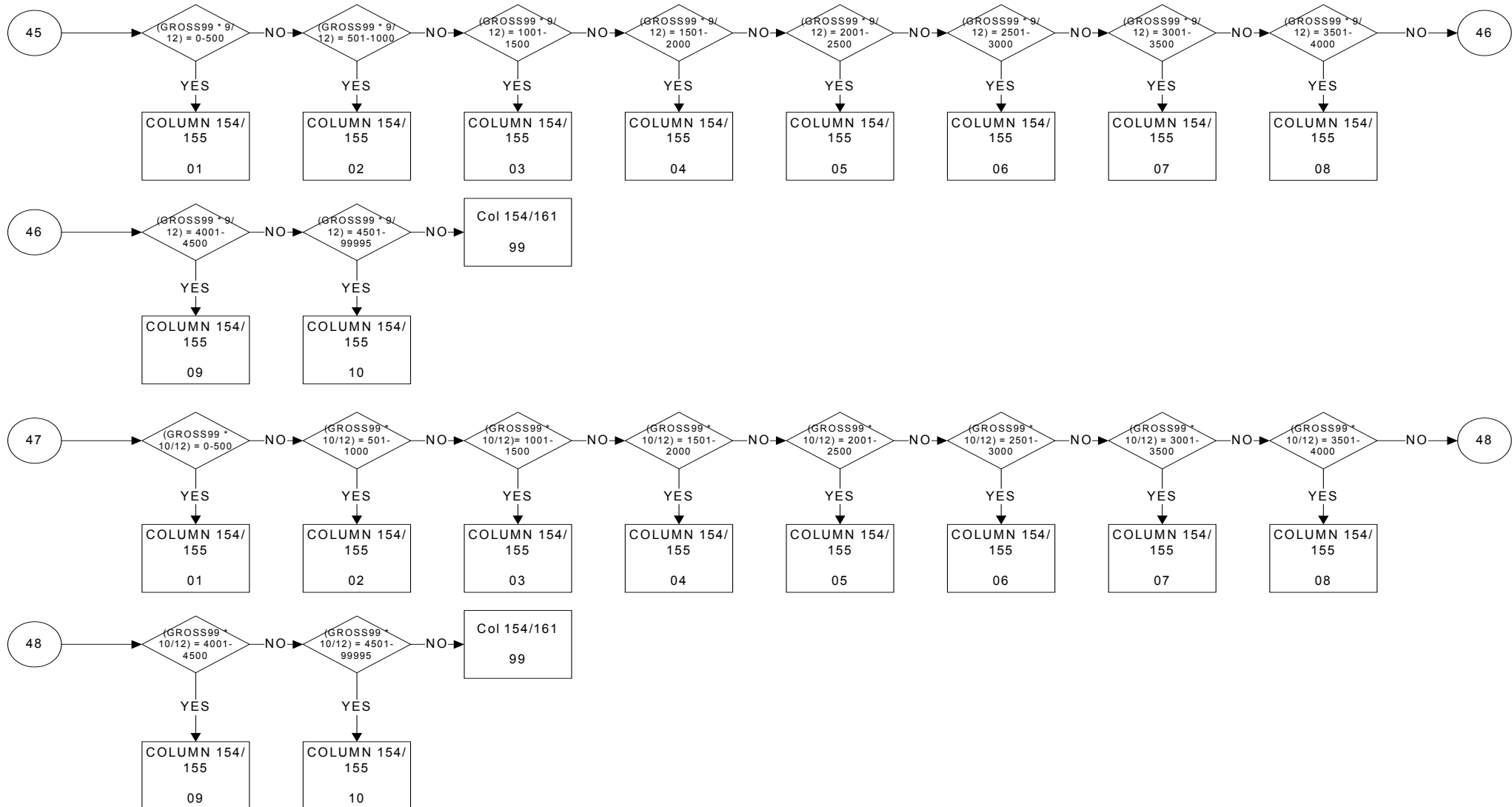

ENTMND: Monthly net (take home) pay from main job

Columns 154/155

PAGE 14 OF 15

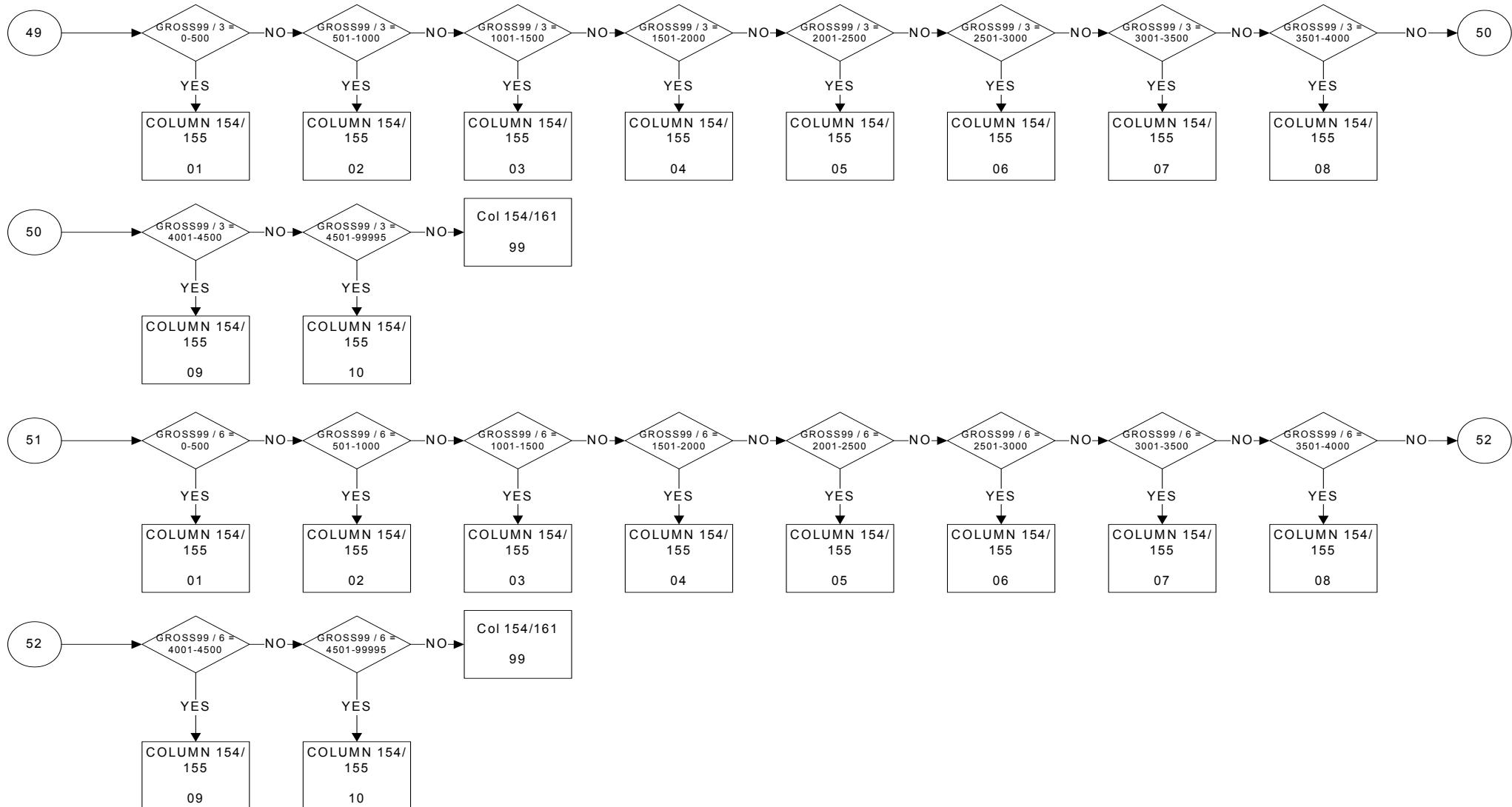

ENTMNDC: Monthly net (take home) pay from main job

Columns 154/155

PAGE 15 OF 15

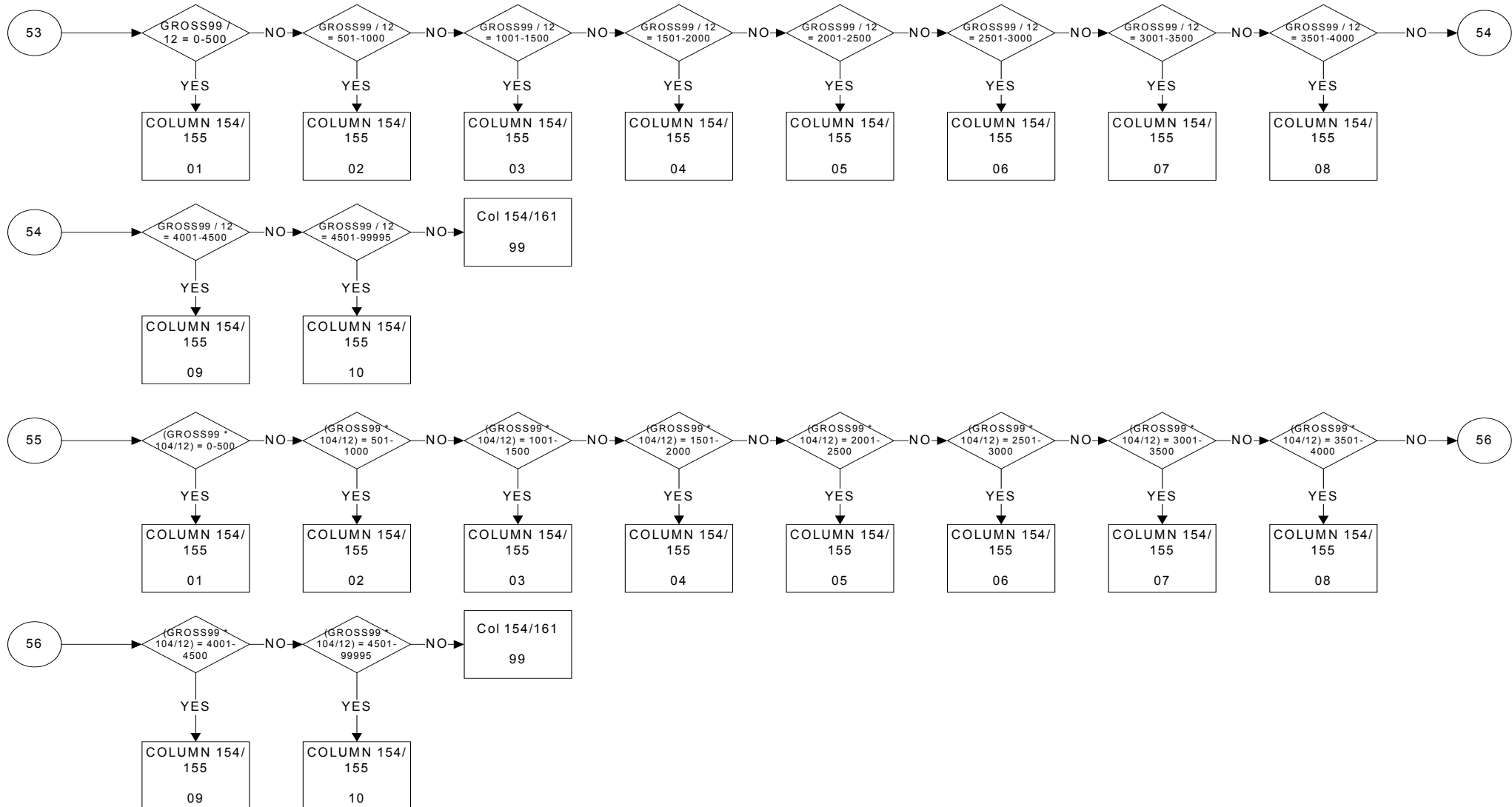

REFYEAR (EYEAR): Year of Survey

Columns 156/159

PAGE 1 OF 1

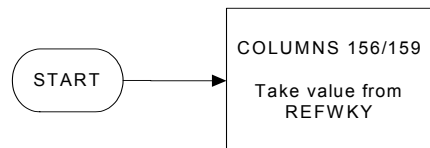

KEY

Year of survey

Last 4 digits of the year

REFWEEK (EREFWK): Reference week

Columns 160/161

PAGE 1 OF 1

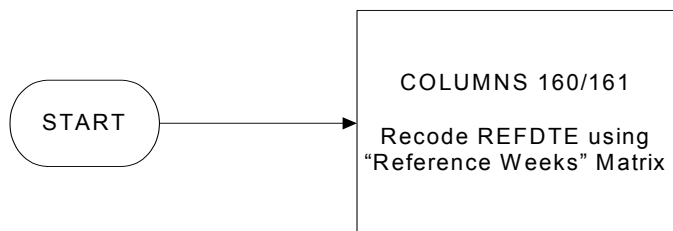

KEY

Number of the week running from Monday to Sunday

INTWEEK (EINTWK): Interview week

Columns 162/163

PAGE 1 OF 1

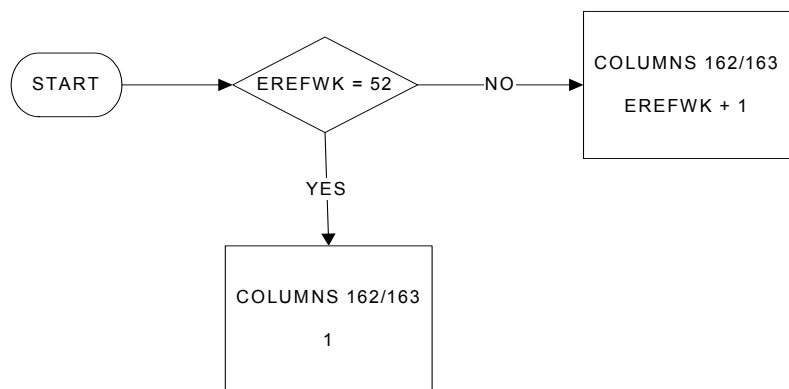

KEY

Number of the week running from Monday to Sunday

COUNTRY (ESTATE): Country

Column 164/165

PAGE 1 OF 1

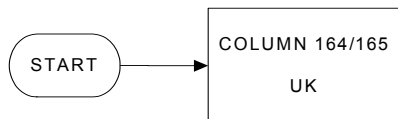

KEY

For coding, see ISO country classification

REGION (EREGN00): Region of household
Column 166/167
PAGE 1 OF 1

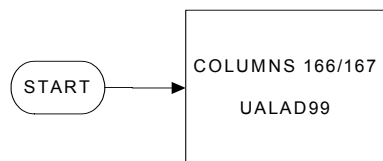

KEY
NUTS 2

DEGURBA (URBAN): Degree of urbanisation

Column 168

PAGE 1 OF 13

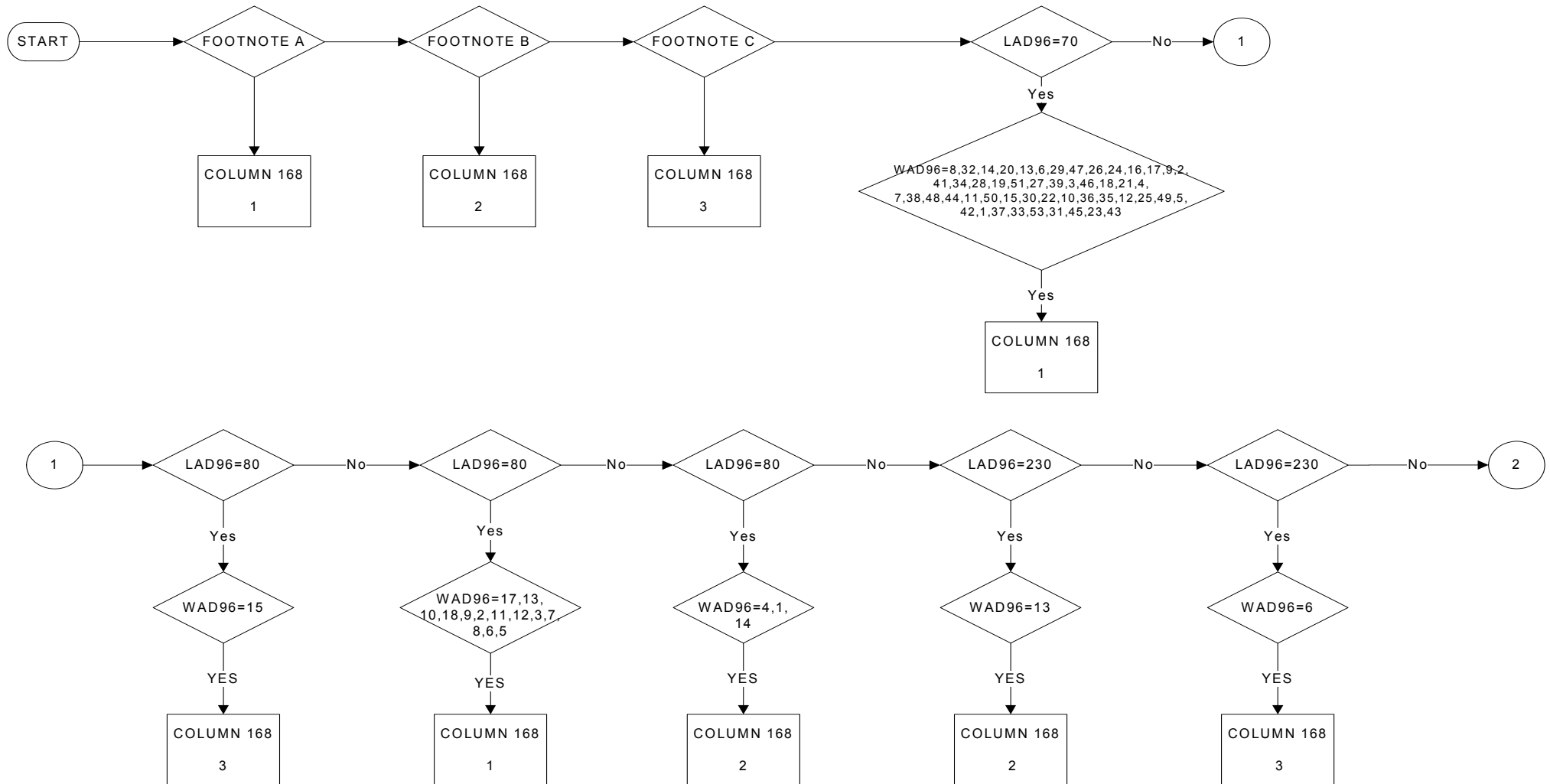

DEGURBA (URBAN): Degree of urbanisation

Column 168

PAGE 2 OF 13

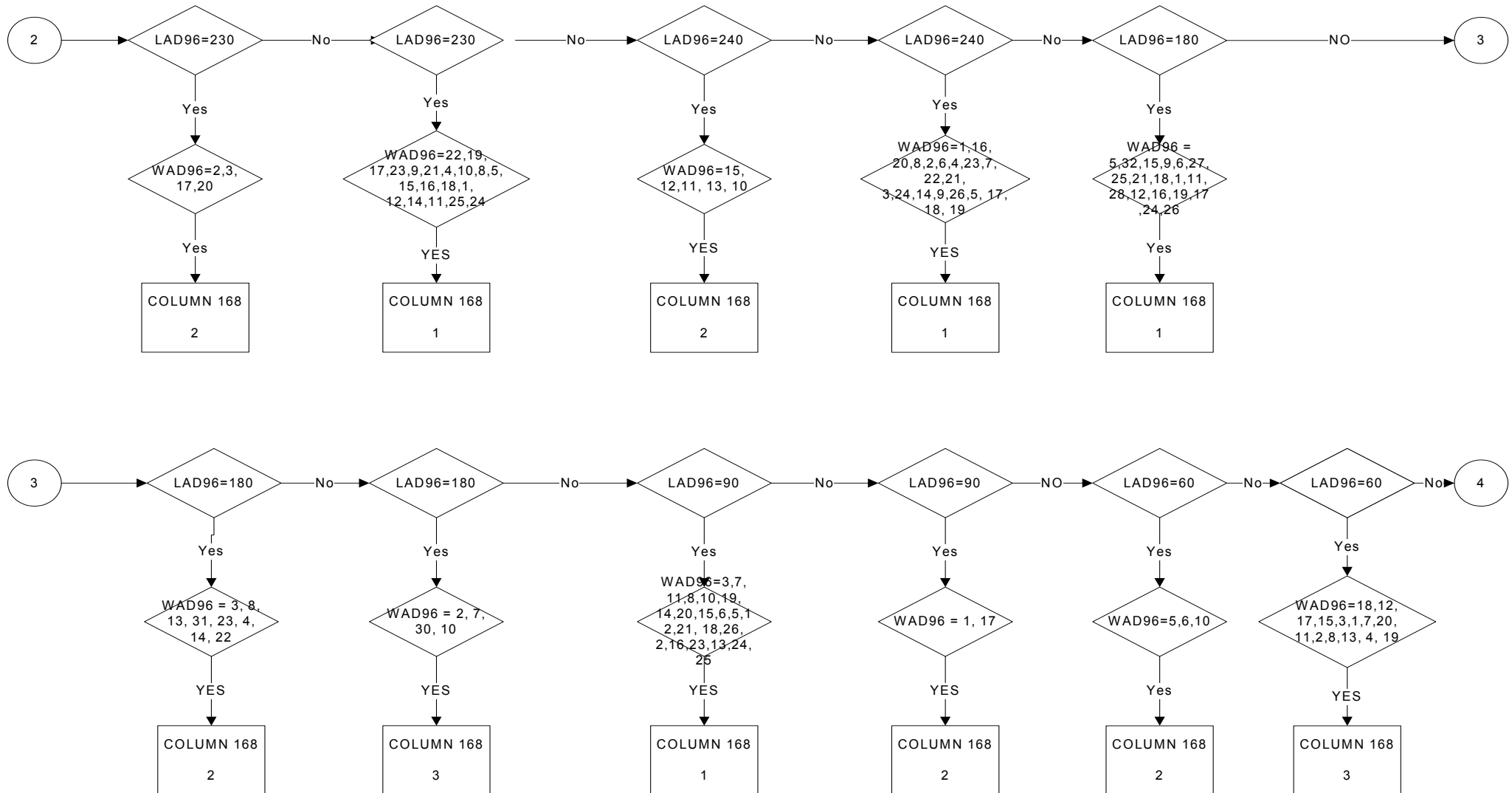

DEGURBA (URBAN): Degree of urbanisation

Column 168

PAGE 3 OF 13

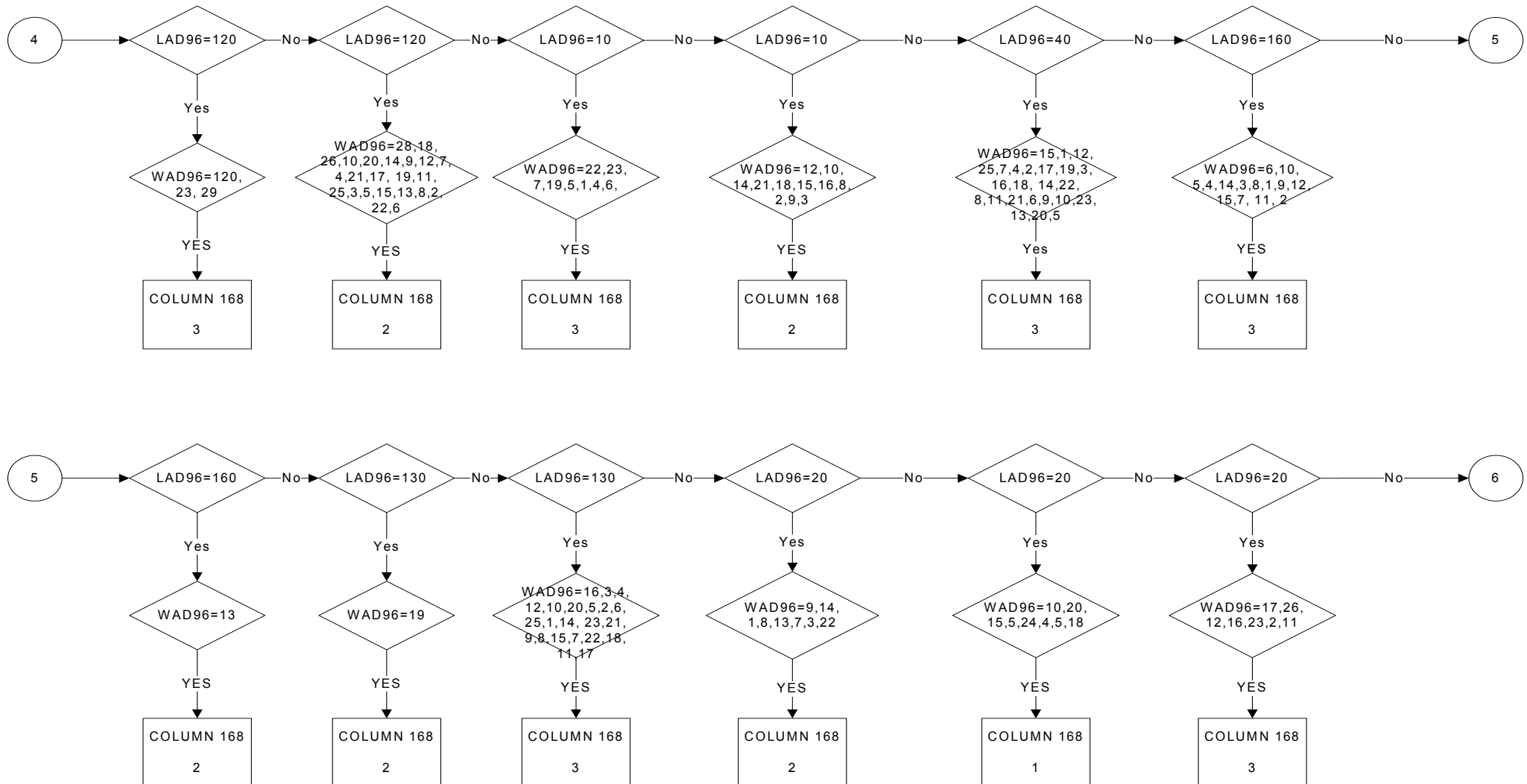

DEGURBA (URBAN): Degree of urbanisation

Column 168

PAGE 4 OF 13

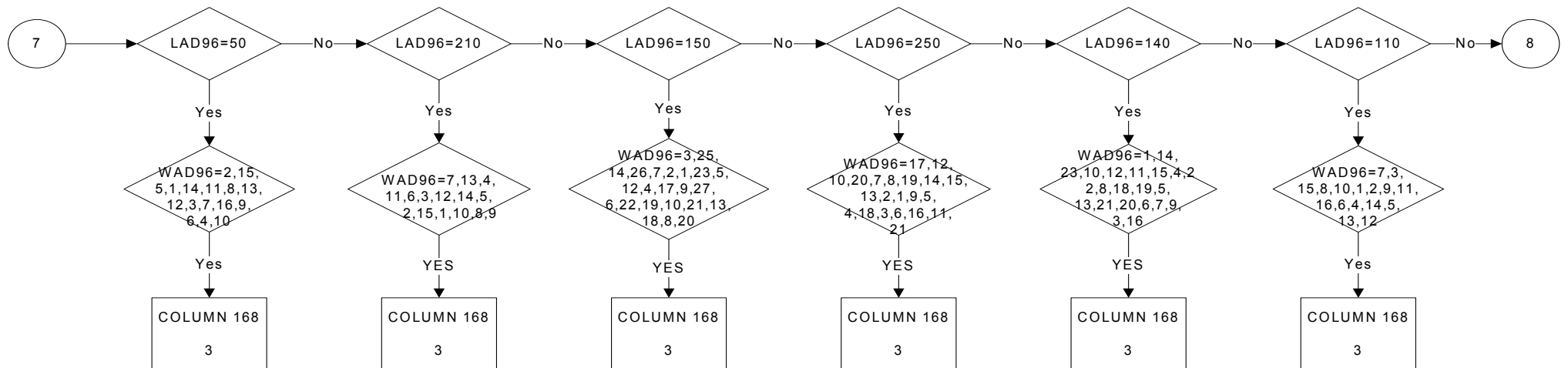
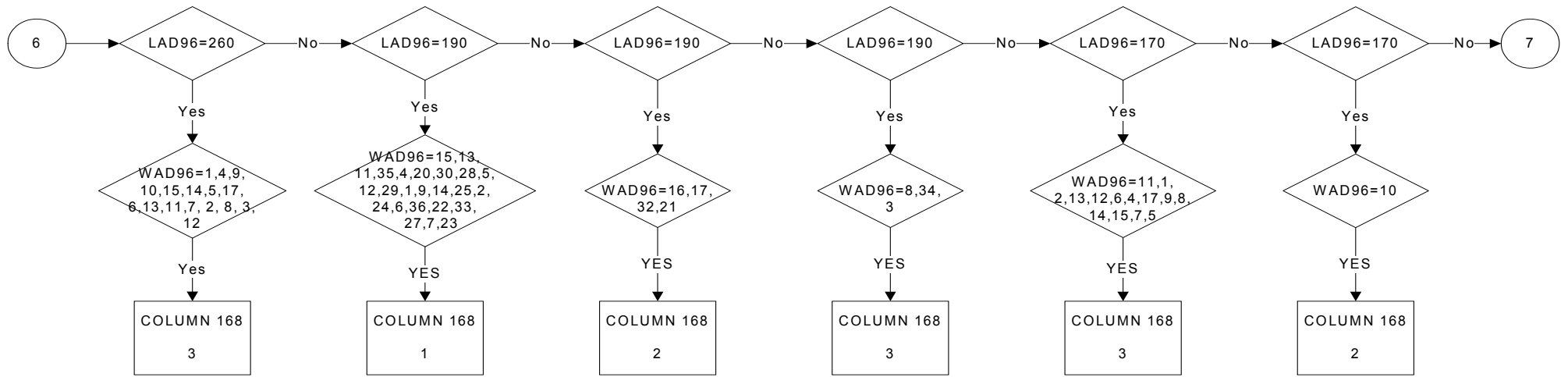

DEGURBA (URBAN): Degree of urbanisation

Column 168

PAGE 5 OF 13

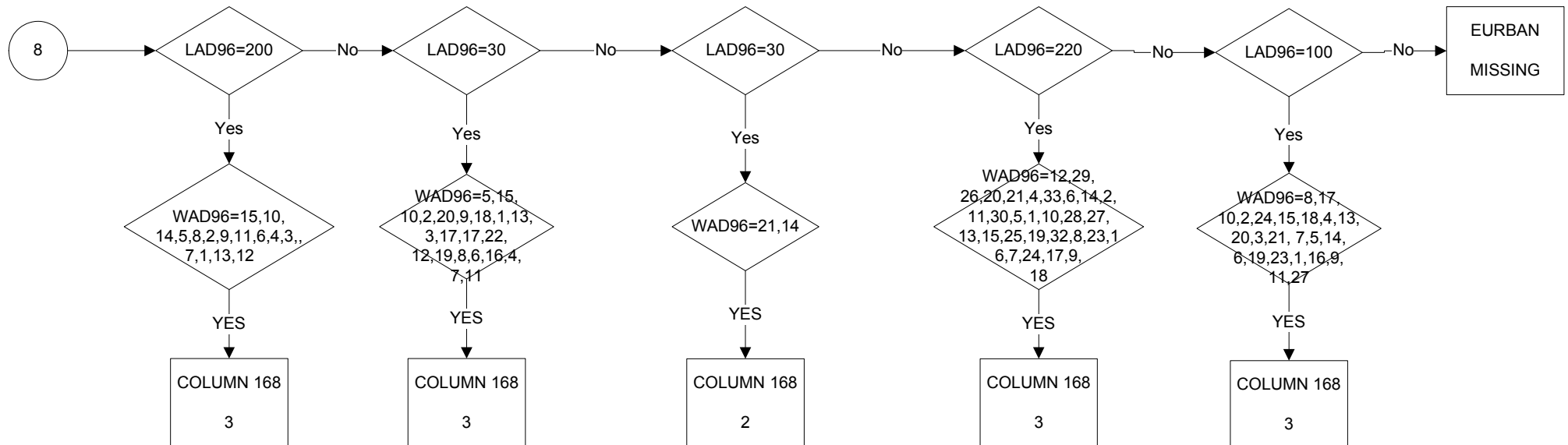

HHNUM (ESERIAL): Serial number of household

Columns 169/174

PAGE 1 OF 1

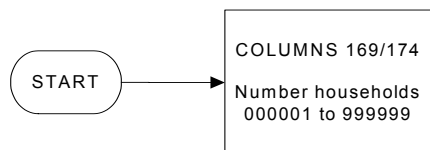

KEY
Serial number are allocated by the national statistical institutes and remain the same for all waves

HHTYPE (ETYPHLD): Type of Household

Column 175
PAGE 1 OF 1

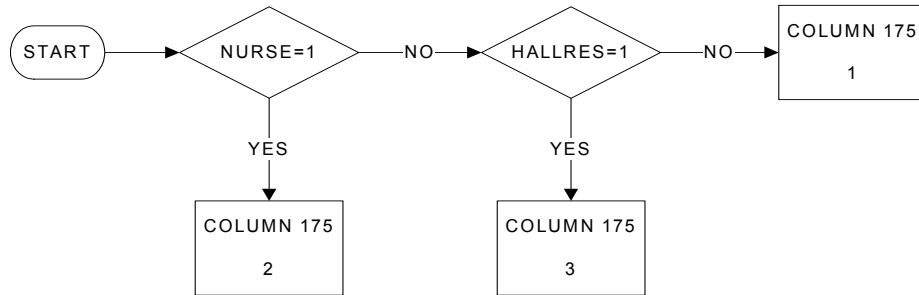

KEY

- 1 Person living in private household (or permanently in a hotel) and surveyed in this household
- 2 Person living in an institution and surveyed in this institution
- 3 Person living in an institution but surveyed in this private household
- 4 Person living in another private household on the territory of the country but surveyed in this household of origin

HHTYPE (ETYPHLD): Type of Household

Column 175
PAGE 1 OF 1

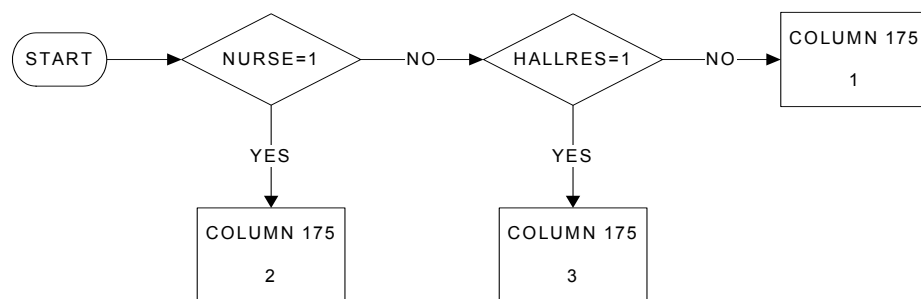

KEY

- 1 Person living in private household (or permanently in a hotel) and surveyed in this household
- 2 Person living in an institution and surveyed in this institution
- 3 Person living in an institution but surveyed in this private household
- 4 Person living in another private household on the territory of the country but surveyed in this household of origin

HHINST (ETYPINS): Type of Institution

Column 176

PAGE 1 OF 1

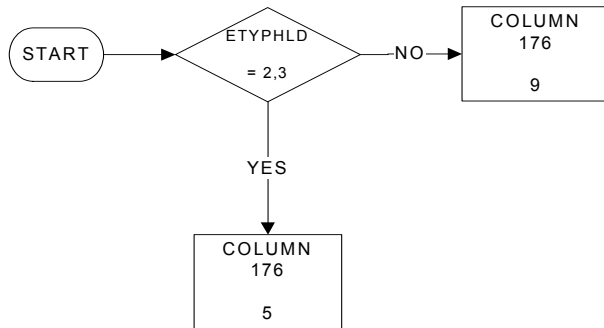

KEY

- 1 Educational institution
- 2 Hospital
- 3 Other welfare institution
- 4 Religious institution (not already included in 1-3)
- 5 Workers' hostel, working quarters at building sites, student hostel, university accommodation etc.
- 6 Military establishment
- 7 Other (e.g. prison)
- 9 Not applicable (HHTYPE = 1,4)
- BLANK No answer

COEFFY (EWEIGHT): Yearly weighting factor

Columns 177/182

PAGE 1 OF 1

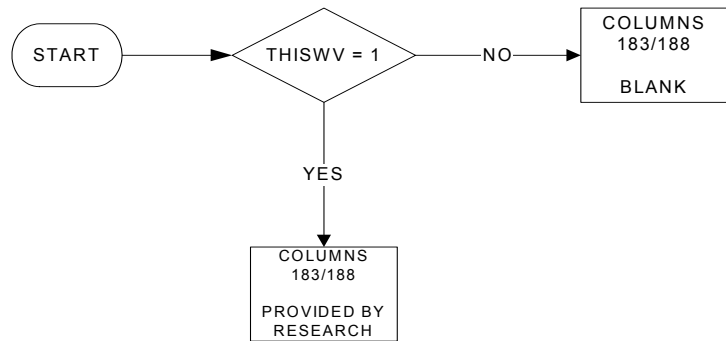

KEY

0000-9999 Cols 183-186 contain whole numbers
00-99 Cols 187-188 contain decimal places

Notes

The yearly weighting factor is provided by research by an annual weight calculated once all quarter data has been received.

COEFFQ (EQWT07): Quarterly weighting factor

Columns 183/188

PAGE 1 OF 1

START

COLUMNS 183/188

The SOEC file quarterly weighting factor will be the same as the UK file. Factor in the format XXXX.XX

KEY

0000-9999 Cols 183-186 contain whole numbers
00-99 Cols 187-188 contain decimal places

COEFFH (EQHHWT): Household yearly weighting factor of the sample for household characteristics (in the case of a sample of individuals)

Columns 189/194

PAGE 1 OF 1

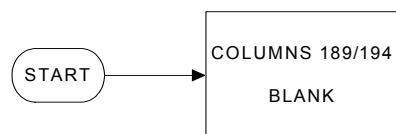

KEY

0000-9999 Cols 189-192 contain whole numbers
00-99 Cols 193-194 contain decimal places

Notes

No weight is submitted to Eurostat

INTWAVE (EWAVE): Sequence number of the survey wave

Column 195
PAGE 1 OF 1

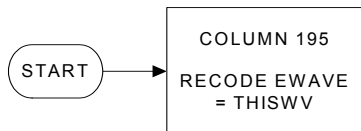

KEY

1-8 Sequence number of the wave

INTQUEST (EINTQUES): Questionnaire used

Column 196
PAGE 1 OF 1

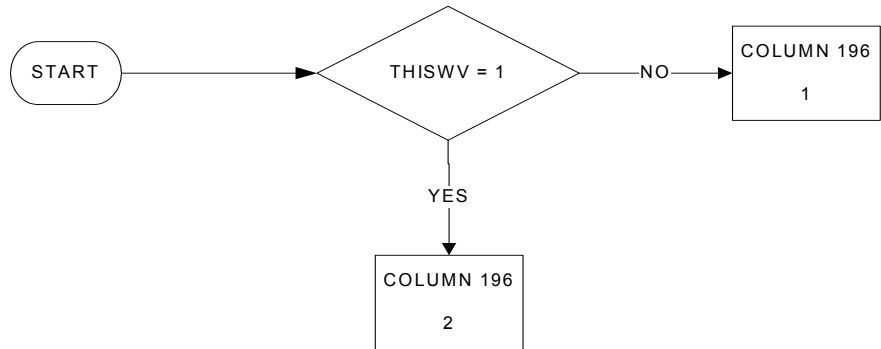

KEY

- 1 Only core variables
- 2 Whole questionnaire

Notes

This variable indicates which cases should be used for creating data on Eurostat structural variables. As this data is collected in wave 1 all quarters it is only wave one cases that can be used with the wave 1 weight (COEFFY, Col. 177-182) to generate this data. Eurostat specify that the records for which yearly variables are available should be coded as INTQUEST (Col. 196) = 2 and the records for which only quarterly variables are available should be coded as INTQUEST = 1.

ANNEX I Regional codes used in the EU Labour Force Survey from 2007 (according to the Classification of Territorial Units (NUTS))

The following codes are used to identify the regions for which data are collected in the EU LFS from 2007 onwards.

BE00		BELGIUM
BE10	Reg. Bruxelles-Cap.- Brussels Hfdst. gewest	
BE21	Antwerpen	
BE22	Limburg (B)	
BE23	Oost-Vlaanderen	
BE24	Vlaams Brabant	
BE25	West-Vlaanderen	
BE31	Brabant Wallon	
BE32	Hainaut	
BE33	Liege	
BE34	Luxembourg (B)	
BE35	Namur	
BG00		BULGARIA
BG31	Severozapaden	
BG32	Severen tsentralen	
BG33	Severozitochten	
BG34	Yugoiztochten	
BG41	Yugozapaden	
BG42	Yuzhen tsentralen	
CZ00		CZECH REPUBLIC
CZ01	Prague	
CZ02	Central Bohemia	
CZ03	Southwest	
CZ04	Northwest	
CZ05	Northeast	
CZ06	Southeast	
CZ07	Central Moravia	
CZ08	Ostrava	
DK00		DENMARK
DK01	Hovedstaden	
DK02	Sjaelland	
DK03	Syddanmark	
DK04	Midtjylland	
DK05	Nordjylland	
DE00		GERMANY
DE11	Stuttgart	
DE12	Karlsruhe	
DE13	Freiburg	
DE14	Tübingen	
DE21	Oberbayern	
DE22	Niederbayern	
DE23	Oberplatz	
DE24	Oberfranken	
DE25	Mittelfranken	
DE26	Unterfranken	
DE27	Schwaben	
DE30	Berlin	
DE41	Brandenburg-Nordost	
DE42	Brandenburg-Südwest	
DE50	Bremen	
DE60	Hamburg	
DE71	Darmstadt	
DE72	Gießen	
DE73	Kassel	
DE80	Mecklenburg-Vorpommern	
DE91	Braunschweig	
DE92	Hannover	
DE93	Lüneburg	
DE94	Weser-Ems	

Labour Force Survey - United Kingdom

DEA1	Düsseldorf	
DEA2	Köln	
DEA3	Münster	
DEA4	Detmold	
DEA5	Arnsberg	
DEB1	Koblenz	
DEB2	Trier	
DEB3	Rheinhessen-Pfalz	
DEC0	Saarland	
DED1	Chemnitz	
DED2	Dresden	
DED3	Leipzig	
DEE0	Sachsen-Anhalt	
DEF0	Schleswig-Holstein	
DEG0	Thüringen	
EE00		ESTONIA
IE00		IRELAND
IE01	Border Midland and Western	
IE02	Southern and Eastern	
GR00		GREECE
GR11	Anatoliki Makedonia - Thraki	
GR12	Kentriki Makedonia	
GR13	Dytiki Makedonia	
GR14	Thessalia	
GR21	Ipeiros	
GR22	Ionia Nisia	
GR23	Dytiki Ellada	
GR24	Sterea Ellada	
GR25	Peloponnisos	
GR30	Attiki	
GR41	Voreio Aigaio	
GR42	Notio Aigaio	
GR43	Kriti	
ES00		SPAIN
ES11	Galicia	
ES12	Principado de Asturias	
ES13	Cantabria	
ES21	Pais Vasco	
ES22	Comunidad Foral de Navarra	
ES23	La Rioja	
ES24	Aragón	
ES30	Comunidad de Madrid	
ES41	Castilla y Leon	
ES42	Castilla la Mancha	
ES43	Extremadura	
ES51	Cataluna	
ES52	Comunidad Valenciana	
ES53	Islas Baleares	
ES61	Andalucia	
ES62	Region de Murcia	
ES63	Ciudad Autónoma de Ceuta	
ES64	Ciudad Autónoma de Melilla	
ES70	Canarias	
FR00		FRANCE
FR10	ile de France	
FR21	Champagne-Ardenne	
FR22	Picardie	
FR23	Haute-Normandie	
FR24	Centre	
FR25	Basse-Normandie	
FR26	Bourgogne	
FR30	Nord - Pas-de-Calais	
FR41	Lorraine	
FR42	Alsace	

Labour Force Survey - United Kingdom

FR43	Franche-Comte	
FR51	Pays de la Loire	
FR52	Bretagne	
FR53	Poitou-Charentes	
FR61	Aquitaine	
FR62	Midi-Pyrenees	
FR63	Limousin	
FR71	Rhone-Alpes	
FR72	Auvergne	
FR81	Languedoc-Roussillon	
FR82	Provence-Alpes-Cote d Azur	
FR83	Corse	
FR91	Guadeloupe	
FR92	Martinique	
FR93	Guyane	
FR94	Reunion	
IT00		ITALY
ITC1	Piemonte	
ITC2	Valle d Aosta/Vallée d Aoste	
ITC3	Liguria	
ITC4	Lombardia	
ITD1	Provincia autonoma Bolzano/Bozen	
ITD2	Provincia autonoma Trento	
ITD3	Veneto	
ITD4	Friuli-Venezia Giulia	
ITD5	Emilia-Romagna	
ITE1	Toscana	
ITE2	Umbria	
ITE3	Marche	
ITE4	Lazio	
ITF1	Abruzzo	
ITF2	Molise	
ITF3	Campania	
ITF4	Puglia	
ITF5	Basilicata	
ITF6	Calabria	
ITG1	Sicilia	
ITG2	Sardegna	
CY00		CYPRUS
LV00		LATVIA
LT00		LITUANIA
LU00		LUXEMBOURG
HU00		HUNGARY
HU10	Kozep-Magyarország	
HU21	Kozep-Dunantul	
HU22	Nyugat-Dunantul	
HU23	Del- Dunantul	
HU31	Eszak-Magyarország	
HU32	Eszak-Alfold	
HU33	Del-Alfold	
MT00		MALTA
NL00		THE NETHERLANDS
NL11	Groningen	
NL12	Friesland (NL)	
NL13	Drenthe	
NL21	Overijssel	
NL22	Gelderland	
NL23	Flevoland	
NL31	Utrecht	
NL32	Noord-Holland	
NL33	Zuid-Holland	

Labour Force Survey - United Kingdom

NL34	Zeeland	
NL41	Noord-Brabant	
NL42	Limburg (NL)	
AT00		AUSTRIA
AT11	Burgenland (A)	
AT12	Niederosterreich	
AT13	Wien	
AT21	Karnten	
AT22	Steiermark	
AT31	Oberosterreich	
AT32	Salzburg	
AT33	Tirol	
AT34	Vorarlberg	
PL00		POLAND
PL11	Lodzkie	
PL12	Mazowieckie	
PL21	Malopolskie	
PL22	Slaskie	
PL31	Lubelskie	
PL32	Podkarpackie	
PL33	Swietokrzyskie	
PL34	Podlaskie	
PL41	Wielkopolskie	
PL42	Zachodniopomorskie	
PL43	Lubuskie	
PL51	Dolnoslaskie	
PL52	Opolskie	
PL61	Kujawsko-Pomorskie	
PL62	Warminsko-Mazurskie	
PL63	Pomorskie	
PT00		PORTUGAL
PT11	Norte	
PT15	Algarve	
PT16	Centro (P)	
PT17	Lisboa	
PT18	Alentejo	
PT20	Região Autónoma dos Açores	
PT30	Região Autónoma da Madeira	
RO00		ROMANIA
RO11	Nord-Vest	
RO12	Centru	
RO21	Nord-Est	
RO22	Sud-Est	
RO31	Sud-Muntenia	
RO32	Bucuresti-Ilfov	
RO41	Sud-Vest Oltenia	
RO42	Vest	
SI00		SLOVENIA
SI01	Vzhodna Slovenija	
SI02	Zahodna Slovenija	
SK00		SLOVAK REPUBLIC
SK01	Bratislava	
SK02	Western Slovakia	
SK03	Central Slovakia	
SK04	Eastern Slovakia	
FI00		FINLAND
FI13	Itä-Suomi	
FI18	Etelä-Suomi	
FI19	Länsi-Suomi	
FI1A	Pohjois-Suomi	
FI20	Åland	

Labour Force Survey - United Kingdom

SE00		SWEDEN
SE11	Stockholm	
SE12	Östra Mellansverige	
SE21	Småland med öarna	
SE22	Sydsverige	
SE23	Västsverige	
SE31	Norra Mellansverige	
SE32	Mellersta Norrland	
SE33	Övre Norrland	
UK00		UNITED KINGDOM
UKC1	Tees Valley - Durham	
UKC2	Northumberland - Tyne and Wear	
UKD1	Cumbria	
UKD2	Cheshire	
UKD3	Greater Manchester	
UKD4	Lancashire	
UKD5	Merseyside	
UKE1	East Yorkshire and Northern Lincolnshire	
UKE2	North Yorkshire	
UKE3	South Yorkshire	
UKE4	West Yorkshire	
UKF1	Derbyshire Nottinghamshire	
UKF2	Leicestershire - Northamptonshire	
UKF3	Lincolnshire	
UKG1	Herefordshire - Worcestershire - Warwickshire	
UKG2	Shropshire - Staffordshire	
UKG3	West Midlands	
UKH1	East Anglia	
UKH2	Bedfordshire - Hertfordshire	
UKH3	Essex	
UKI1	Inner London	
UKI2	Outer London	
UKJ1	Berkshire - Bucks - Oxfordshire	
UKJ2	Surrey - East-West Sussex	
UKJ3	Hampshire - Isle of Wight	
UKJ4	Kent	
UKK1	Gloucestershire - Wiltshire - Bristol - Bath Area	
UKK2	Dorset - Somerset	
UKK3	Cornwall - Isles of Scilly	
UKK4	Devon	
UKL1	West Wales - the Valleys	
UKL2	East Wales	
UKM2	Eastern Scotland	
UKM3	South Western Scotland	
UKM5	North Eastern Scotland	
UKM6	Highlands - Islands	
UKN0	Northern Ireland	
HR00		CROATIA
HR01	Sjeverozapadna Hrvatska	
HR02	Sredisnja i Istocna (Panonska) Hrvatska	
HR03	Jadranska Hrvatska	
MK00		FYRMAKEDONIA
TR00		TURKEY
TR10	Istanbul	
TR21	Tekirdag	
TR22	Balikesir	
TR31	Izmir	
TR32	Aydin	
TR33	Manisa	
TR41	Bursa	
TR42	Kocaeli	
TR51	Ankara	
TR52	Konia	
TR61	Antalya	
TR62	Adana	

Labour Force Survey - United Kingdom

TR63	Hatay	
TR71	Kirrikale	
TR72	Kayseri	
TR81	Zonguldak	
TR82	Kastamonu	
TR83	Samsun	
TR90	Trabzon	
TRA1	Erzurum	
TRA2	Agri	
TRB1	Malatya	
TRB2	Van	
TRC1	Gaziantep	
TRC2	Sanliurfa	
TRC3	Mardin	
CH00		SWITZERLAND
CH01	Region lemanique	
CH02	Espace Mittelland	
CH03	Nordwestschweiz	
CH04	Zurich	
CH05	Ostschweiz	
CH06	Zentralschweiz	
CH07	Ticino	
IS00		ICELAND
LI00		LIECHTENSTEIN
NO00		NORWAY
NO01	Oslo og Akershus	
NO02	Hedmark og Oppland	
NO03	Soer-Ostlandet	
NO04	Agder og Rogaland	
NO05	Vestlandet	
NO06	Troendelag	
NO07	Nord-Norge	

ANNEX II **Statistical Classification of economic activities at 2 and 3 digits
(NACE Rev. 2 – used from 2009 onwards)**

<i>A</i>	<i>AGRICULTURE, FORESTRY AND FISHING</i>
01	Crop and animal production, hunting and related service activities
01.1	Growing of non-perennial crops
01.2	Growing of perennial crops
01.3	Plant propagation
01.4	Animal production
01.5	Mixed farming
01.6	Support activities to agriculture and post-harvest crop activities
01.7	Hunting, trapping and related service activities
02	Forestry and logging
02.1	Silviculture and other forestry activities
02.2	Logging
02.3	Gathering of wild growing non-wood products
02.4	Support services to forestry
03	Fishing and aquaculture
03.1	Fishing
03.2	Aquaculture
<i>B</i>	<i>MINING AND QUARRYING</i>
05	Mining of coal and lignite
05.1	Mining of hard coal
05.2	Mining of lignite
06	Extraction of crude petroleum and natural gas
06.1	Extraction of crude petroleum
06.2	Extraction of natural gas
07	Mining of metal ores
07.1	Mining of iron ores
07.2	Mining of non-ferrous metal ores
08	Other mining and quarrying
08.1	Quarrying of stone, sand and clay
08.9	Mining and quarrying n.e.c.
09	Mining support service activities
09.1	Support activities for petroleum and natural gas extraction
09.9	Support activities for other mining and quarrying
<i>C</i>	<i>MANUFACTURING</i>
10	Manufacture of food products
10.1	Processing and preserving of meat and production of meat products
10.2	Processing and preserving of fish, crustaceans and molluscs
10.3	Processing and preserving of fruit and vegetables
10.4	Manufacture of vegetable and animal oils and fats

10.5	Manufacture of dairy products
10.6	Manufacture of grain mill products, starches and starch products
10.7	Manufacture of bakery and farinaceous products
10.8	Manufacture of other food products
10.9	Manufacture of prepared animal feeds
11	Manufacture of beverages
11.0	Manufacture of beverages
12	Manufacture of tobacco products
12.0	Manufacture of tobacco products
13	Manufacture of textiles
13.1	Preparation and spinning of textile fibres
13.2	Weaving of textiles
13.3	Finishing of textiles
13.9	Manufacture of other textiles
14	Manufacture of wearing apparel
14.1	Manufacture of wearing apparel, except fur apparel
14.2	Manufacture of articles of fur
14.3	Manufacture of knitted and crocheted apparel
15	Manufacture of leather and related products
15.1	Tanning and dressing of leather; manufacture of luggage, handbags, saddlery and harness; dressing and dyeing of fur
15.2	Manufacture of footwear
16	Manufacture of wood and of products of wood and cork, except furniture; manufacture of articles of straw and plaiting materials
16.1	Sawmilling and planing of wood
16.2	Manufacture of products of wood, cork, straw and plaiting materials
17	Manufacture of paper and paper products
17.1	Manufacture of pulp, paper and paperboard
17.2	Manufacture of articles of paper and paperboard
18	Printing and reproduction of recorded media
18.1	Printing and service activities related to printing
18.2	Reproduction of recorded media
19	Manufacture of coke and refined petroleum products
19.1	Manufacture of coke oven products
19.2	Manufacture of refined petroleum products
20	Manufacture of chemicals and chemical products
20.1	Manufacture of basic chemicals, fertilisers and nitrogen compounds, plastics and synthetic rubber in primary forms
20.2	Manufacture of pesticides and other agrochemical products
20.3	Manufacture of paints, varnishes and similar coatings, printing ink and mastics
20.4	Manufacture of soap and detergents, cleaning and polishing preparations, perfumes and toilet preparations
20.5	Manufacture of other chemical products
20.6	Manufacture of man-made fibres
21	Manufacture of basic pharmaceutical products and pharmaceutical preparations
21.1	Manufacture of basic pharmaceutical products
21.2	Manufacture of pharmaceutical preparations
22	Manufacture of rubber and plastic products
22.1	Manufacture of rubber products
22.2	Manufacture of plastics products
23	Manufacture of other non-metallic mineral products
23.1	Manufacture of glass and glass products

23.2	Manufacture of refractory products
23.3	Manufacture of clay building materials
23.4	Manufacture of other porcelain and ceramic products
23.5	Manufacture of cement, lime and plaster
23.6	Manufacture of articles of concrete, cement and plaster
23.7	Cutting, shaping and finishing of stone
23.9	Manufacture of abrasive products and non-metallic mineral products n.e.c.
24	Manufacture of basic metals
24.1	Manufacture of basic iron and steel and of ferro-alloys
24.2	Manufacture of tubes, pipes, hollow profiles and related fittings, of steel
24.3	Manufacture of other products of first processing of steel
24.4	Manufacture of basic precious and other non-ferrous metals
24.5	Casting of metals
25	Manufacture of fabricated metal products, except machinery and equipment
25.1	Manufacture of structural metal products
25.2	Manufacture of tanks, reservoirs and containers of metal
25.3	Manufacture of steam generators, except central heating hot water boilers
25.4	Manufacture of weapons and ammunition
25.5	Forging, pressing, stamping and roll-forming of metal; powder metallurgy
25.6	Treatment and coating of metals; machining
25.7	Manufacture of cutlery, tools and general hardware
25.9	Manufacture of other fabricated metal products
26	Manufacture of computer, electronic and optical products
26.1	Manufacture of electronic components and boards
26.2	Manufacture of computers and peripheral equipment
26.3	Manufacture of communication equipment
26.4	Manufacture of consumer electronics
26.5	Manufacture of instruments and appliances for measuring, testing and navigation; watches and clocks
26.6	Manufacture of irradiation, electromedical and electrotherapeutic equipment
26.7	Manufacture of optical instruments and photographic equipment
26.8	Manufacture of magnetic and optical media
27	Manufacture of electrical equipment
27.1	Manufacture of electric motors, generators, transformers and electricity distribution and control apparatus
27.2	Manufacture of batteries and accumulators
27.3	Manufacture of wiring and wiring devices
27.4	Manufacture of electric lighting equipment
27.5	Manufacture of domestic appliances
27.9	Manufacture of other electrical equipment
28	Manufacture of machinery and equipment n.e.c.
28.1	Manufacture of general — purpose machinery
28.2	Manufacture of other general-purpose machinery
28.3	Manufacture of agricultural and forestry machinery
28.4	Manufacture of metal forming machinery and machine tools
28.9	Manufacture of other special-purpose machinery
29	Manufacture of motor vehicles, trailers and semi-trailers
29.1	Manufacture of motor vehicles
29.2	Manufacture of bodies (coachwork) for motor vehicles; manufacture of trailers and semi-trailers
29.3	Manufacture of parts and accessories for motor vehicles
30	Manufacture of other transport equipment

30.1	Building of ships and boats
30.2	Manufacture of railway locomotives and rolling stock
30.3	Manufacture of air and spacecraft and related machinery
30.4	Manufacture of military fighting vehicles
30.9	Manufacture of transport equipment n.e.c.
31	Manufacture of furniture
31.0	Manufacture of furniture
32	Other manufacturing
32.1	Manufacture of jewellery, bijouterie and related articles
32.2	Manufacture of musical instruments
32.3	Manufacture of sports goods
32.4	Manufacture of games and toys
32.5	Manufacture of medical and dental instruments and supplies
32.9	Manufacturing n.e.c.
33	Repair and installation of machinery and equipment
33.1	Repair of fabricated metal products, machinery and equipment
33.2	Installation of industrial machinery and equipment
<i>D</i>	<i>ELECTRICITY, GAS, STEAM AND AIR CONDITIONING SUPPLY</i>
35	Electricity, gas, steam and air conditioning supply
35.1	Electric power generation, transmission and distribution
35.2	Manufacture of gas; distribution of gaseous fuels through mains
35.3	Steam and air conditioning supply
<i>E</i>	<i>WATER SUPPLY; SEWERAGE, WASTE MANAGEMENT AND REMEDIATION ACTIVITIES</i>
36	Water collection, treatment and supply
36.0	Water collection, treatment and supply
37	Sewerage
37.0	Sewerage
38	Waste collection, treatment and disposal activities; materials recovery
38.1	Waste collection
38.2	Waste treatment and disposal
38.3	Materials recovery
39	Remediation activities and other waste management services
39.0	Remediation activities and other waste management services
<i>F</i>	<i>CONSTRUCTION</i>
41	Construction of buildings
41.1	Development of building projects
41.2	Construction of residential and non-residential buildings
42	Civil engineering
42.1	Construction of roads and railways
42.2	Construction of utility projects
42.9	Construction of other civil engineering projects
43	Specialised construction activities
43.1	Demolition and site preparation

43.2	Electrical, plumbing and other construction installation activities
43.3	Building completion and finishing
43.9	Other specialised construction activities
<i>G</i>	<i>WHOLESALE AND RETAIL TRADE; REPAIR OF MOTOR VEHICLES AND MOTORCYCLES</i>
45	Wholesale and retail trade and repair of motor vehicles and motorcycles
45.1	Sale of motor vehicles
45.2	Maintenance and repair of motor vehicles
45.3	Sale of motor vehicle parts and accessories
45.4	Sale, maintenance and repair of motorcycles and related parts and accessories
46	Wholesale trade, except of motor vehicles and motorcycles
46.2	Wholesale of agricultural raw materials and live animals
46.3	Wholesale of food, beverages and tobacco
46.4	Wholesale of household goods
46.5	Wholesale of information and communication equipment
46.6	Wholesale of other machinery, equipment and supplies
46.7	Other specialised wholesale
46.9	Non-specialised wholesale trade
47	Retail trade, except of motor vehicles and motorcycles
47.1	Retail sale in non-specialised stores
47.2	Retail sale of food, beverages and tobacco in specialised stores
47.3	Retail sale of automotive fuel in specialised stores
47.4	Retail sale of information and communication equipment in specialised stores
47.5	Retail sale of other household equipment in specialised stores
47.6	Retail sale of cultural and recreation goods in specialised stores
47.7	Retail sale of other goods in specialised stores
47.8	Retail sale via stalls and markets
47.9	Retail trade not in stores, stalls or markets
<i>H</i>	<i>TRANSPORTATION AND STORAGE</i>
49	Land transport and transport via pipelines
49.1	Passenger rail transport, interurban
49.2	Freight rail transport
49.3	Other passenger land transport
49.4	Freight transport by road and removal services
49.5	Transport via pipeline
50	Water transport
50.1	Sea and coastal passenger water transport
50.2	Sea and coastal freight water transport
50.3	Inland passenger water transport
50.4	Inland freight water transport
51	Air transport
51.1	Passenger air transport
51.2	Freight air transport and space transport
52	Warehousing and support activities for transportation
52.1	Warehousing and storage
52.2	Support activities for transportation

53	Postal and courier activities
53.1	Postal activities under universal service obligation
53.2	Other postal and courier activities
<i>I</i>	<i>ACCOMMODATION AND FOOD SERVICE ACTIVITIES</i>
55	Accommodation
55.1	Hotels and similar accommodation
55.2	Holiday and other short-stay accommodation
55.3	Camping grounds, recreational vehicle parks and trailer parks
55.9	Other accommodation
56	Food and beverage service activities
56.1	Restaurants and mobile food service activities
56.2	Event catering and other food service activities
56.3	Beverage serving activities
<i>J</i>	<i>INFORMATION AND COMMUNICATION</i>
58	Publishing activities
58.1	Publishing of books, periodicals and other publishing activities
58.2	Software publishing
59	Motion picture, video and television programme production, sound recording and music publishing activities
59.1	Motion picture, video and television programme activities
59.2	Sound recording and music publishing activities
60	Programming and broadcasting activities
60.1	Radio broadcasting
60.2	Television programming and broadcasting activities
61	Telecommunications
61.1	Wired telecommunications activities
61.2	Wireless telecommunications activities
61.3	Satellite telecommunications activities
61.9	Other telecommunications activities
62	Computer programming, consultancy and related activities
62.0	Computer programming, consultancy and related activities
63	Information service activities
63.1	Data processing, hosting and related activities; web portals
63.9	Other information service activities
<i>K</i>	<i>FINANCIAL AND INSURANCE ACTIVITIES</i>
64	Financial service activities, except insurance and pension funding
64.1	Monetary intermediation
64.2	Activities of holding companies
64.3	Trusts, funds and similar financial entities
64.9	Other financial service activities, except insurance and pension funding
65	Insurance, reinsurance and pension funding, except compulsory social security
65.1	Insurance
65.2	Reinsurance
65.3	Pension funding

66	Activities auxiliary to financial services and insurance activities
66.1	Activities auxiliary to financial services, except insurance and pension funding
66.2	Activities auxiliary to insurance and pension funding
66.3	Fund management activities
<i>L</i>	<i>REAL ESTATE ACTIVITIES</i>
68	Real estate activities
68.1	Buying and selling of own real estate
68.2	Renting and operating of own or leased real estate
68.3	Real estate activities on a fee or contract basis
<i>M</i>	<i>PROFESSIONAL, SCIENTIFIC AND TECHNICAL ACTIVITIES</i>
69	Legal and accounting activities
69.1	Legal activities
69.2	Accounting, bookkeeping and auditing activities; tax consultancy
70	Activities of head offices; management consultancy activities
70.1	Activities of head offices
70.2	Management consultancy activities
71	Architectural and engineering activities; technical testing and analysis
71.1	Architectural and engineering activities and related technical consultancy
71.2	Technical testing and analysis
72	Scientific research and development
72.1	Research and experimental development on natural sciences and engineering
72.2	Research and experimental development on social sciences and humanities
73	Advertising and market research
73.1	Advertising
73.2	Market research and public opinion polling
74	Other professional, scientific and technical activities
74.1	Specialised design activities
74.2	Photographic activities
74.3	Translation and interpretation activities
74.9	Other professional, scientific and technical activities n.e.c.
75	Veterinary activities
75.0	Veterinary activities
<i>N</i>	<i>ADMINISTRATIVE AND SUPPORT SERVICE ACTIVITIES</i>
77	Rental and leasing activities
77.1	Renting and leasing of motor vehicles
77.2	Renting and leasing of personal and household goods
77.3	Renting and leasing of other machinery, equipment and tangible goods
77.4	Leasing of intellectual property and similar products, except copyrighted works
78	Employment activities
78.1	Activities of employment placement agencies
78.2	Temporary employment agency activities
78.3	Other human resources provision
79	Travel agency, tour operator reservation service and related activities

Labour Force Survey - United Kingdom

79.1	Travel agency and tour operator activities
79.9	Other reservation service and related activities
80	Security and investigation activities
80.1	Private security activities
80.2	Security systems service activities
80.3	Investigation activities
81	Services to buildings and landscape activities
81.1	Combined facilities support activities
81.2	Cleaning activities
81.3	Landscape service activities
82	Office administrative, office support and other business support activities
82.1	Office administrative and support activities
82.2	Activities of call centres
82.3	Organisation of conventions and trade shows
82.9	Business support service activities n.e.c.
<i>O</i>	<i>PUBLIC ADMINISTRATION AND DEFENCE; COMPULSORY SOCIAL SECURITY</i>
84	Public administration and defence; compulsory social security
84.1	Administration of the State and the economic and social policy of the community
84.2	Provision of services to the community as a whole
84.3	Compulsory social security activities
<i>P</i>	<i>EDUCATION</i>
85	Education
85.1	Pre-primary education
85.2	Primary education
85.3	Secondary education
85.4	Higher education
85.5	Other education
85.6	Educational support activities
<i>Q</i>	<i>HUMAN HEALTH AND SOCIAL WORK ACTIVITIES</i>
86	Human health activities
86.1	Hospital activities
86.2	Medical and dental practice activities
86.9	Other human health activities
87	Residential care activities
87.1	Residential nursing care activities
87.2	Residential care activities for mental retardation, mental health and substance abuse
87.3	Residential care activities for the elderly and disabled
87.9	Other residential care activities
88	Social work activities without accommodation
88.1	Social work activities without accommodation for the elderly and disabled
88.9	Other social work activities without accommodation
<i>R</i>	<i>ARTS, ENTERTAINMENT AND RECREATION</i>

90	Creative, arts and entertainment activities
90.0	Creative, arts and entertainment activities
91	Libraries, archives, museums and other cultural activities
91.0	Libraries, archives, museums and other cultural activities
92	Gambling and betting activities
92.0	Gambling and betting activities
93	Sports activities and amusement and recreation activities
93.1	Sports activities
93.2	Amusement and recreation activities
<i>S</i>	<i>OTHER SERVICE ACTIVITIES</i>
94	Activities of membership organisations
94.1	Activities of business, employers and professional membership organisations
94.2	Activities of trade unions
94.9	Activities of other membership organisations
95	Repair of computers and personal and household goods
95.1	Repair of computers and communication equipment
95.2	Repair of personal and household goods
96	Other personal service activities
96.0	Other personal service activities
<i>T</i>	<i>ACTIVITIES OF HOUSEHOLDS AS EMPLOYERS; UNDIFFERENTIATED GOODS- AND SERVICES- PRODUCING ACTIVITIES OF HOUSEHOLDS FOR OWN USE</i>
97	Activities of households as employers of domestic personnel
97.0	Activities of households as employers of domestic personnel
98	Undifferentiated goods- and services-producing activities of private households for own use
98.1	Undifferentiated goods-producing activities of private households for own use
98.2	Undifferentiated service-producing activities of private households for own use
<i>U</i>	<i>ACTIVITIES OF EXTRATERRITORIAL ORGANISATIONS AND BODIES</i>
99	Activities of extraterritorial organisations and bodies
99.0	Activities of extraterritorial organisations and bodies

ANNEX III – International Standard classification of occupations 2, 3 and 4 digits (ISCO-88 (com))

MAJOR GROUP 1: LEGISLATORS, SENIOR OFFICIALS AND MANAGERS

11	Legislators and senior officials
111	Legislators and senior government officials
1110	Legislators and senior government officials
114	Senior officials of special-interest organisations
1141	Senior officials of political party organisations
1142	Senior officials of employers', workers' and other economic-interest organisations
1143	Senior officials of humanitarian and other special-interest organisations
12	Corporate managers
121	Directors and chief executives
1210	Directors and chief executives
122	Production and operations managers
1221	Production and operations managers in agriculture, hunting, forestry and fishing
1222	Production and operations managers in manufacturing
1223	Production and operations managers in construction
1224	Production and operations managers in wholesale and retail trade
1225	Production and operations managers in restaurants and hotels
1226	Production and operations managers in transport, storage and communications
1227	Production and operations managers in business services enterprises
1228	Production and operations managers in personal care, cleaning and related services
1229	Production and operations managers not elsewhere classified
123	Other specialist managers
1231	Finance and administration managers
1232	Personnel and industrial relations managers
1233	Sales and marketing managers
1234	Advertising and public relations managers
1235	Supply and distribution managers
1236	Computing services managers
1237	Research and development managers
1239	Other specialist managers not elsewhere classified
13	Managers of small enterprises
131	Managers of small enterprises
1311	Managers of small enterprises in agriculture, hunting, forestry and fishing
1312	Managers of small enterprises in manufacturing
1313	Managers of small enterprises in construction
1314	Managers of small enterprises in wholesale and retail trade
1315	Managers of small enterprises of restaurants and hotels
1316	Managers of small enterprises in transport, storage and communications
1317	Managers of small enterprises in business services enterprises
1318	Managers of small enterprises in personal care, cleaning and related services
1319	Managers of small enterprises not elsewhere classified

MAJOR GROUP 2: PROFESSIONALS

21	Physical, mathematical and engineering science professionals
211	Physicists, chemists and related professionals
2111	Physicists and astronomers
2112	Meteorologists
2113	Chemists
2114	Geologists and geophysicists
212	Mathematicians, statisticians and related professionals
2121	Mathematicians and related professionals
2122	Statisticians
213	Computing professionals
2131	Computer systems designers, analysts and programmers
2139	Computing professionals not elsewhere classified
214	Architects, engineers and related professionals

Labour Force Survey - United Kingdom

	2141	Architects, town and traffic planners
	2142	Civil engineers
	2143	Electrical engineers
	2144	Electronics and telecommunications engineers
	2145	Mechanical engineers
	2146	Chemical engineers
	2147	Mining engineers, metallurgists and related professionals
	2148	Cartographers and surveyors
	2149	Architects, engineers and related professionals not elsewhere classified
22	Life science and health professionals	
	221	Life science professionals
	2211	Biologists, botanists, zoologists and related professionals
	2212	Pharmacologists, pathologists and related professionals
	2213	Agronomists and related professionals
	222	Health professionals (except nursing)
	2221	Medical doctors
	2222	Dentists
	2223	Veterinarians
	2224	Pharmacists
	2229	Health professionals (except nursing) not elsewhere classified
	223	Nursing and midwifery professionals
	2230	Nursing and midwifery professionals
23	Teaching professionals	
	231	College, university and higher education teaching professionals
	2310	College, university and higher education teaching professionals
	232	Secondary education teaching professionals
	2320	Secondary education teaching professionals
	233	Primary and pre-primary education teaching professionals
	2331	Primary education teaching professionals
	2332	Pre-primary education teaching professionals
	234	Special education teaching professionals
	2340	Special education teaching professionals
	235	Other teaching professionals
	2351	Education methods specialists
	2352	School inspectors
	2359	Other teaching professionals not elsewhere classified
24	Other professionals	
	241	Business professionals
	2411	Accountants
	2412	Personnel and careers professionals
	2419	Business professionals not elsewhere classified
	242	Legal professionals
	2421	Lawyers
	2422	Judges
	2429	Legal professionals not elsewhere classified
	243	Archivists, librarians and related information professionals
	2431	Archivists and curators
	2432	Librarians and related information professionals
	244	Social science and related professionals
	2441	Economists
	2442	Sociologists, anthropologists and related professionals
	2443	Philosophers, historians and political scientists
	2444	Philologists, translators and interpreters
	2445	Psychologists
	2446	Social work professionals
	245	Writers and creative or performing artists
	2451	Authors, journalists and other writers
	2452	Sculptors, painters and related artists
	2453	Composers, musicians and singers
	2454	Choreographers and dancers

	2455	Film, stage and related actors and directors
246	Religious professionals	
	2460	Religious professionals
247	Public service administrative professionals	
	2470	Public service administrative professionals

MAJOR GROUP 3: TECHNICIANS AND ASSOCIATE PROFESSIONALS

31	Physical and engineering science associate professionals	
	311	Physical and engineering science technicians
		3111 Chemical and physical science technicians
		3112 Civil engineering technicians
		3113 Electrical engineering technicians
		3114 Electronics and telecommunications engineering technicians
		3115 Mechanical engineering technicians
		3116 Chemical engineering technicians
		3117 Mining and metallurgical technicians
		3118 Draughtspersons
		3119 Physical and engineering science technicians not elsewhere classified
	312	Computer associate professionals
		3121 Computer assistants
		3122 Computer equipment operators
		3123 Industrial robot controllers
	313	Optical and electronic equipment operators
		3131 Photographers and image and sound recording equipment operators
		3132 Broadcasting and telecommunications equipment operators
		3133 Medical equipment operators
		3139 Optical and electronic equipment operators not elsewhere classified
	314	Ship and aircraft controllers and technicians
		3141 Ships' engineers
		3142 Ships' deck officers and pilots
		3143 Aircraft pilots and related associate professionals
		3144 Air traffic controllers
		3145 Air traffic safety technicians
	315	Safety and quality inspectors
		3151 Building and fire inspectors
		3152 Safety, health and quality inspectors
32	Life science and health associate professionals	
	321	Life science technicians and related associate professional
		3211 Life science technicians
		3212 Agronomy and forestry technicians
		3213 Farming and forestry advisers
	322	Health associate professionals (except nursing)
		3221 Medical assistants
		3222 Hygienists, health and environmental officers
		3223 Dieticians and nutritionists
		3224 Optometrists and opticians
		3225 Dental assistants
		3226 Physiotherapists and related associate professionals
		3227 Veterinary assistants
		3228 Pharmaceutical assistants
		3229 Health associate professionals (except nursing) not elsewhere classified
	323	Nursing and midwifery associate professionals
		3231 Nursing associate professionals
		3232 Midwifery associate professionals
33	Teaching associate professionals	
	331	Primary education teaching associate professionals
		3310 Primary education teaching associate professionals
	332	Pre-primary education teaching associate professionals
		3320 Pre-primary education teaching associate professionals

333	Special education teaching associate professionals
3330	Special education teaching associate professionals
334	Other teaching associate professionals
3340	Other teaching associate professionals
34	Other associate professionals
341	Finance and sales associate professionals
3411	Securities and finance dealers and brokers
3412	Insurance representatives
3413	Estate agents
3414	Travel consultants and organisers
3415	Technical and commercial sales representatives
3416	Buyers
3417	Appraisers, valuers and auctioneers
3419	Finance and sales associate professionals not elsewhere classified
342	Business services agents and trade brokers
3421	Trade brokers
3422	Clearing and forwarding agents
3423	Employment agents and labour contractors
3429	Business services agents and trade brokers not elsewhere classified
343	Administrative associate professionals
3431	Administrative secretaries and related associate professionals
3432	Legal and related business associate professionals
3433	Bookkeepers
3434	Statistical, mathematical and related associate professionals
344	Customs, tax and related government associate professionals
3441	Customs and border inspectors
3442	Government tax and excise officials
3443	Government social benefits officials
3444	Government licensing officials
3449	Customs, tax and related government associate professionals not elsewhere classified
345	Police inspectors and detectives
3450	Police inspectors and detectives
346	Social work associate professionals
3460	Social work associate professionals
347	Artistic, entertainment and sports associate professionals
3471	Decorators and commercial designers
3472	Radio, television and other announcers
3473	Street, night-club and related musicians, singers and dancers
3474	Clowns, magicians, acrobats and related associate professionals
3475	Athletes, sports persons and related associate professionals
348	Religious associate professionals
3480	Religious associate professionals

MAJOR GROUP 4: CLERKS

41	Office clerks
411	Secretaries and keyboard-operating clerks
4111	Stenographers and typists
4112	Word-processor and related operators
4113	Data entry operators
4114	Calculating-machine operators
4115	Secretaries
412	Numerical clerks
4121	Accounting and book-keeping clerks
4122	Statistical and finance clerks
413	Material-recording and transport clerks
4131	Stock clerks
4132	Production clerks
4133	Transport clerks

414	Library, mail and related clerks
4141	Library and filing clerks
4142	Mail carriers and sorting clerks
4143	Coding, proof-reading and related clerks
4144	Scribes and related workers
419	Other office clerks
4190	Other office clerks
42	Customer services clerks
421	Cashiers, tellers and related clerks
4211	Cashiers and ticket clerks
4212	Tellers and other counter clerks
4213	Bookmakers and croupiers
4214	Pawnbrokers and money-lenders
4215	Debt-Collectors and related workers
422	Client information clerks
4221	Travel agency and related clerks
4222	Receptionists and information clerks
4223	Telephone switchboard operators

MAJOR GROUP 5: SERVICE WORKERS AND SHOP AND MARKET SALES WORKERS

51	Personal and protective services workers
511	Travel attendants and related workers
5111	Travel attendants and travel stewards
5112	Transport conductors
5113	Travel guides
512	Housekeeping and restaurant services workers
5121	Housekeepers and related workers
5122	Cooks
5123	Waiters, waitresses and bartenders
513	Personal care and related workers
5131	Child-care workers
5132	Institution-based personal care workers
5133	Home-based personal care workers
5139	Personal care and related workers not elsewhere classified
514	Other personal services workers
5141	Hairdressers, barbers, beauticians and related workers
5142	Companions and valets
5143	Undertakers and embalmers
5149	Other personal services workers not elsewhere classified
516	Protective services workers
5161	Fire-fighters
5162	Police officers
5163	Prison guards
5169	Protective services workers not elsewhere classified
52	Models, salespersons and demonstrators
521	Fashion and other models
5210	Fashion and other models
522	Shop, stall and market salespersons and demonstrators
5220	Shop, stall and market salespersons and demonstrators

MAJOR GROUP 6: SKILLED AGRICULTURAL AND FISHERY WORKERS

61	Skilled agricultural and fishery workers
611	Market gardeners and crop growers
6111	Field crop and vegetable growers
6112	Gardeners, horticultural and nursery growers
612	Animal producers and related workers
6121	Dairy and livestock producers
6122	Poultry producers

	6129	Animal producers and related workers not elsewhere classified
613	Crop and animal producers	
	6130	Crop and animal producers
614	Forestry and related workers	
	6141	Forestry workers and loggers
	6142	Charcoal burners and related workers
615	Fishery workers, hunters and trappers	
	6151	Aquatic life cultivation workers
	6152	Inland and coastal waters fishery workers
	6153	Deep-sea fishery workers
	6154	Hunters and trappers

MAJOR GROUP 7: CRAFT AND RELATED TRADES WORKERS

71	Extraction and building trades workers	
	711	Miners, shotfirers, stone cutters and carvers
		7111 Miners and quarry workers
		7112 Shotfirers and blasters
		7113 Stone splitters, cutters and carvers
	712	Building frame and related trades workers
		7121 Builders
		7122 Bricklayers and stonemasons
		7123 Concrete placers, concrete finishers and related workers
		7124 Carpenters and joiners
		7129 Building frame and related trades workers not elsewhere classified
	713	Building finishers and related trades workers
		7131 Roofers
		7132 Floor layers and tile setters
		7133 Plasterers
		7134 Insulation workers
		7135 Glaziers
		7136 Plumbers and pipe fitters
		7137 Building and related electricians
		7139 Building finishers and related trade workers not elsewhere classified
	714	Painters, building structure cleaners and related trades workers
		7141 Painters and related workers
		7143 Building structure cleaners
72	Metal, machinery and related trades workers	
	721	Metal moulders, welders, sheet-metal workers, structural-metal preparers, and related trades workers
		7211 Metal moulders and coremakers
		7212 Welders and flame cutters
		7213 Sheet-metal workers
		7214 Structural-metal preparers and erectors
		7215 Riggers and cable splicers
		7216 Underwater workers
	722	Blacksmiths, tool-makers and related trades workers
		7221 Blacksmiths, hammer-smiths and forging-press workers
		7222 Tool-makers and related workers
		7223 Machine-tool setters and setter-operators
		7224 Metal wheel-grinders, polishers and tool sharpeners
	723	Machinery mechanics and fitters
		7231 Motor vehicle mechanics and fitters
		7232 Aircraft engine mechanics and fitters
		7233 Agricultural- or industrial-machinery mechanics and fitters
	724	Electrical and electronic equipment mechanics and fitters
		7241 Electrical mechanics fitters and services
		7242 Electronics mechanics, fitters and services
		7243 Electronics mechanics and services
		7244 Telegraph and telephone installers and services
		7245 Electrical line installers, repairers and cable jointers
73	Precision, handicraft, craft printing and related trades workers	

731	Precision workers in metal and related materials
	7311 Precision-instrument makers and repairers
	7312 Musical-instrument makers and tuners
	7313 Jewellery and precious-metal workers
732	Potters, glass-makers and related trades workers
	7321 Abrasive wheel formers, potters and related workers
	7322 Glass-makers, cutters, grinders and finishers
	7323 Glass engravers and etchers
	7324 Glass, ceramics and related decorative painters
733	Handicraft workers in wood, textile, leather and related materials
	7331 Handicraft workers in wood and related materials
	7332 Handicraft workers in textile, leather and related materials
734	Craft printing and related trades workers
	7341 Compositors, typesetters and related workers
	7342 Stereotypes and electrotypers
	7343 Printing engravers and etchers
	7344 Photographic and related workers
	7345 Bookbinders and related workers
	7346 Silk-screen, block and craft textile printers
74	Other craft and related trades workers
741	Food processing and related trades workers
	7411 Butchers, fishmongers and related food preparers
	7412 Bakers, pastry-cooks and confectionery makers
	7413 Dairy-products workers
	7414 Fruit, vegetable and related preservers
	7415 Food and beverage tasters and graders
	7416 Tobacco preparers and tobacco products makers
742	Wood treaters, cabinet-makers and related trades workers
	7421 Wood treaters
	7422 Cabinetmakers and related workers
	7423 Woodworking machine setters and setter-operators
	7424 Basketry weavers, brush makers and related workers
743	Textile, garment and related trades workers
	7431 Fibre preparers
	7432 Weavers, knitters and related workers
	7433 Tailors, dressmakers and hatters
	7434 Furriers and related workers
	7435 Textile, leather and related pattern-makers and cutters
	7436 Sewers, embroiderers and related workers
	7437 Upholsterers and related workers
744	Pelt, leather and shoemaking trades workers
	7441 Pelt dressers, tanners and fellmongers
	7442 Shoe-makers and related workers
MAJOR GROUP 8: PLANT AND MACHINE OPERATORS AND ASSEMBLERS	
81	Stationary plant and related operators
811	Mining and mineral-processing-plant operators
	8111 Mining plant operators
	8112 Mineral-ore and stone-processing-plant operators
	8113 Well drillers and borers and related workers
812	Metal-processing plant operators
	8121 Ore and metal furnace operators
	8122 Metal melters, casters and rolling-mill operators
	8123 Metal heat-treating-plant operators
	8124 Metal drawers and extruders
813	Glass, ceramics and related plant operators
	8131 Glass and ceramics kiln and related machine operators
	8139 Glass, ceramics and related plant operators not elsewhere classified
814	Wood-processing- and papermaking-plant operators
	8141 Wood-processing-plant operators
	8142 Paper-pulp plant operators

	8143	Papermaking-plant operators
815		Chemical-processing-plant operators
	8151	Crushing-, grinding- and chemical-mixing-machinery operators
	8152	Chemical-heat-treating-plant operators
	8153	Chemical-filtering- and separating-equipment operators
	8154	Chemical-still and reactor operators (except petroleum and natural gas)
	8155	Petroleum- and natural-gas-refining-plant operators
	8159	Chemical-processing-plant operators not elsewhere classified
816		Power-production and related plant operators
	8161	Power-production plant operators
	8162	Steam-engine and boiler operators
	8163	Incinerator, water-treatment and related plant operators
817		Industrial robot operators
	8170	Industrial robot operators
82		Machine operators and assemblers
821		Metal- and mineral-products machine operators
	8211	Machine-tool operators
	8212	Cement and other mineral products machine operators
822		Chemical-products machine operators
	8221	Pharmaceutical-and toiletry-products machine operators
	8222	Ammunition- and explosive-products machine operators
	8223	Metal finishing-, plating- and coating-machine operators
	8224	Photographic-products machine operators
	8229	Chemical-products machine operators not elsewhere classified
823		Rubber- and plastic-products machine operators
	8231	Rubber-products machine operators
	8232	Plastic-products machine operators
824		Wood-products machine operators
	8240	Wood-products machine operators
825		Printing-, binding- and paper-products machine operators
	8251	Printing-machine operators
	8252	Book-binding-machine operators
	8253	Paper-products machine operators
826		Textile-, fur- and leather-products machine operators
	8261	Fibre-preparing-, spinning- and winding-machine operators
	8262	Weaving- and knitting-machine operators
	8263	Sewing-machine operators
	8264	Bleaching-, dyeing- and cleaning-machine operators
	8265	Fur- and leather-preparing-machine operators
	8266	Shoemaking- and related machine operators
	8269	Textile-, fur- and leather-products machine operators not elsewhere classified
827		Food and related products machine operators
	8271	Meat- and fish-processing-machine operators
	8272	Dairy-products machine operators
	8273	Grain- and spice-milling-machine operators
	8274	Baked-goods, cereal- and chocolate-products machine operators
	8275	Fruit-, vegetable- and nut-processing-machine operators
	8276	Sugar production machine operators
	8277	Tea-, coffee- and cocoa-processing-machine operators
	8278	Brewers, wine and other beverage machine operators
	8279	Tobacco production machine operators
828		Assemblers
	8281	Mechanical-machinery assemblers
	8282	Electrical-equipment assemblers
	8283	Electronic-equipment assemblers
	8284	Metal-, rubber- and plastic-products assemblers
	8285	Wood and related products assemblers
	8286	Paperboard, textile and related products assemblers
	8287	Composite products assemblers
829		Other machine operators not elsewhere classified

	8290	Other machine operators not elsewhere classified
83		Drivers and mobile plant operators
	831	Locomotive engine drivers and related workers
	8311	Locomotive engine drivers
	8312	Railway brakemen, signallers and shunters
	832	Motor vehicle drivers
	8321	Motorcycle drivers
	8322	Car, taxi and van drivers
	8323	Bus and tram drivers
	8324	Heavy truck and lorry drivers
	833	Agricultural and other mobile plant operators
	8331	Motorised farm and forestry plant operators
	8332	Earth-moving and related plant operators
	8333	Crane, hoist and related plant operators
	8334	Lifting-truck operators
	834	Ships' deck crews and related workers
	8340	Ships' deck crews and related workers

MAJOR GROUP 9: ELEMENTARY OCCUPATIONS

91		Sales and services elementary occupations
	911	Street vendors and related workers
	9111	Street vendors
	9113	Door-to-door and telephone salespersons
	912	Shoe cleaning and other street services elementary occupations
	9120	Shoe cleaning and other street services elementary occupations
	913	Domestic and related helpers, cleaners and launderers
	9131	Domestic helpers and cleaners
	9132	Helpers and cleaners in offices, hotels and other establishments
	9133	Hand-launderers and pressers
	914	Building caretakers, window and related cleaners
	9141	Building caretakers
	9142	Vehicle, window and related cleaners
	915	Messengers, porters, doorkeepers and related workers
	9151	Messengers, package and luggage porters and deliverers
	9152	Doorkeepers, watchpersons and related workers
	9153	Vending-machine money Collectors, meter readers and related workers
	916	Garbage Collectors and related labourers
	9161	Garbage Collectors
	9162	Sweepers and related labourers
92		Agricultural, fishery and related labourers
	921	Agricultural, fishery and related labourers
	9211	Farm-hands and labourers
	9212	Forestry labourers
	9213	Fishery, hunting and trapping labourers
93		Labourers in mining, construction, manufacturing and transport
	931	Mining and construction labourers
	9311	Mining and quarrying labourers
	9312	Construction and maintenance labourers: roads, dams, and similar constructions
	9313	Building construction labourers
	932	Manufacturing labourers
	9320	Manufacturing labourers
	933	Transport labourers and freight handlers
	9330	Transport labourers and freight handlers

MAJOR GROUP 0: ARMED FORCES

01	Armed forces		
	010	Armed forces	
		0100	Armed forces

Annex IV - ISO country classification in the LFS from 2009 onwards

These codes apply to the variables: nationality, country of birth, country of place of work and country of residence one year before survey.

EUROPEAN UNION		OTHER EUROPEAN COUNTRIES		6 OTHER AFRICA	
BE	Belgium	AD	Andorra	AO	Angola
CZ	Czech Republic	AL	Albania	BF	Burkina Faso
DK	Denmark	BA	Bosnia Herzegovina	BI	Burundi
DE	Germany	BY	Belarus	BJ	Benin
EE	Estonia	MD	Republic of Moldova	BW	Botswana
GR	Greece	MK	FYRMacedonia	CD	Republic Democratic of Congo Central African Republic
ES	Spain	RU	Russian Federation	CF	Congo
FR	France	SM	San Marino	CG	Ivory Coast
IE	Ireland	UA	Ukraine	CI	Cameroon
IT	Italy	VA	Vatican City	CM	Cape Verde
CY	Cyprus	XK	Kosovo	CV	Djibouti
LV	Latvia	ME	Montenegro	DJ	Eritrea
LT	Lithuania	RS	Serbia	ER	
LU	Luxembourg	CS	*Serbia - Montenegro	ET	Ethiopia
HU	Hungary			GA	Gabon
MT	Malta		5 NORTH AFRICA	GH	Ghana
NL	Netherlands	DZ	Algeria	GM	Gambia
AT	Austria	EG	Egypt	GN	Guinea
PL	Poland	LY	Libya	GQ	Equatorial Guinea
PT	Portugal	MA	Morocco	GW	Guinea-Bissau
SI	Slovenia	TN	Tunisia	KE	Kenya
SK	Slovak Republic	MR	Mauritania	LR	Liberia
FI	Finland	MU	Mauritius	LS	Lesotho
SE	Sweden	MW	Malawi	MG	Madagascar
UK	United Kingdom	MZ	Mozambique	ML	Mali
		NA	Namibia		
		NE	Niger		7 NORTH AMERICA
		NG	Nigeria	BM	Bermuda
		RW	Rwanda	CA	Canada
		SC	Seychelles	GL	Greenland
		SD	Sudan	PM	Saint Pierre and Miquelon
		SL	Sierra Leone	US	United States of America
		SN	Senegal		
		SO	Somalia		
		ST	Sao Tome and Principe		
		SZ	Swaziland		
		TD	Chad		
		TG	Togo		
		TZ	Tanzania		
		UG	Uganda		
		ZA	South Africa		
		ZM	Zambia		
		ZW	Zimbabwe		

* to be used temporarily

	8 CENTRAL AMERICA AND CARRIBEAN		10 EAST ASIA	IN	India
AG	Antigua and Barbuda	CN	China	KH	Cambodia
AN	Netherlands Antilles	JP	Japan	KP	Dem. People's Republic of Korea (North)
BB	Barbados	TW	Taiwan	KR	Republic of Korea (South)
BS	Bahamas			LA	Laos
			NEAR AND MIDDLE EAST	LK	Sri Lanka
BZ	Belize	AE	United Arab Emirates	MM	Myanmar
CR	Costa Rica	AM	Armenia	MN	Mongolia
CU	Cuba	AZ	Azerbaijan	MV	Maldives
DO	Dominican Republic	BH	Bahrein	MY	Malaysia
DM	Dominica	GE	Georgia	NP	Nepal
GD	Grenada	IL	Israel	PH	Philippines
GT	Guatemala	IQ	Iraq	PK	Pakistan
HN	Honduras	IR	Iran	SG	Singapore
HT	Haiti	JO	Jordan	TH	Thailand
JM	Jamaica	KG	Kyrgyzstan	TL	East Timor
MX	Mexico	KW	Kuwait	VN	Vietnam
NI	Nicaragua	KZ	Kazakhstan		
PA	Panama				
				13 AUSTRALIA, OCEANIA AND OTHER TERRITORIES	
PR	Puerto Rico	LB	Lebanon	AU	Australia
SV	El Salvador	OM	Oman	FJ	Fiji
TT	Trinidad and Tobago	PS	Palestine	FM	Micronesia
		QA	Qatar		
			Saudi		
9 SOUTH AMERICA		SA	Arabia	NC	New Caledonia
AR	Argentina	SY	Syria	NZ	New Zealand
BO	Bolivia	TJ	Tajikistan	PF	French Polynesia
BR	Brazil	TM	Turkmenistan	PG	Papua New Guinea
CL	Chile	UZ	Uzbeksitan	SB	Solomon Islands
CO	Colombia	YE	Yemen	VU	Vanuatu
EC	Ecuador				
		12 SOUTH AND SOUTH EAST ASIA		14 OTHER + STATELESS	
GY	Guyana		Afghanista		
			n		
PE	Peru	AF		Blank	No answer
PY	Paraguay	BD	Bangladesh		
SR	Surinam	BN	Brunei		
UY	Uruguay	BT	Bhutan		
VE	Venezuela	ID	Indonesia		